















Sospensioni, Lampade da soffitto, Lampade da parete,
Lampade da tavolo, Lampade da terra, Sistemi,
Proiettori, Binari, Lampade da incasso, Bollard, Lampadine,
Accessori / Interno, Esterno / Minimal, Decorativo,
Architettonico / **Luce e design al servizio delle persone.**

Light up your 2023.

ideal lux.

ideal lux.[®]

Indice

		Indice alfabetico	004
		Indice icone	008
		Introduzione azienda	032
<hr/>			
Interni		Sospensioni	050
		Lampade da soffitto	248
		Lampade da parete	344
		Lampade da tavolo	444
		Lampade da terra	488
		Sistemi	532
		Proiettori e binari	606
		Lampade da incasso	656
<hr/>			
Esterni		Sospensioni e soffitto	720
		Lampade da parete	732
		Bollard e lampade da tavolo	774
		Proiettori	816
		Incassi	830
<hr/>			
Lampadine		Lampadine e accessori	844
		Indice famiglie	866
		Indice per codice	882

Craft

Pag 502



Abc	91	Birds	94	Chalet	242
Acqua	797	Birds	319	Chalet	438
Admiral	335	Birds	413	Chalet	480
Agos	788	Birds	466	Channel	699
Alfa	314	Birds	492	Cima	770
Alfa	407	Birillo	463	Cima	814
Alfiere	474	Bistrò	182	Circus	67
Ali	377	Bit	832	Citrus	109
A-Line	116	Blanche	214	Clara	276
Alma	386	Blossom	142	Classic Globe	811
Almond	330	Blues	716	Click	361
Amadeus	220	Boa	165	Clio	724
Ampolla	106	Bollicine	157	Clio	769
Andromeda	761	Bon Bon	237	Clio	812
Angolo	326	Bonjour	387	Clip	359
Angolo	467	Book	403	Cloe	189
Angolo	496	Bow	388	Cloud	286
Apollo	751	Box	357	Clown	156
Arca	534	Breeze	123	Cocktail	135
Argo	759	Bright	362	Coco	178
Aria	148	Brigitta	235	Colonna	526
Arizona	154	Bubble	730	Colossal	216
Arizona	284	Bubble	768	Cometa	766
Atena	804	Byte	639	Comfort	506
Audi-10	184	Caesar	209	Compo	331
Audi-20	144	Caesar	341	Cono	132
Audi-77	207	Calypso	196	Copernico	100
Audi-80	185	Calypso	432	Corte	228
Audio	497	Camerino	380	Corte	435
Aura	297	Canapa	244	Cosmo	809
Avenue	835	Candy	155	Cosmopolitan	325
Avion	175	Candy	285	Cover	354
Axel	470	Candy	460	Craft	83
Axel	517	Cantina	129	Craft	364
Barber	406	Cantina	418	Craft	502
Base	754	Carlton	202	Cube	360
Basic	688	Carlton	343	Cylinder	189
Basket	173	Carlton	433	Cylinder	524
Bean	396	Carrara	443	Daddy	514
Bento	658	Carta	164	Dafne	771
Bergen	181	Casanova	232	Dafne	815
Bijoux	338	Celine	277	Daisy	330

Indice alfabetico

Danieli	234	Ego	548	Florian	436	Gru	450	Kepler	101
Dea	320	Electric	245	Fluo	574	Gun	727	Kepler	414
Deca	246	Elio	738	Flut	139	Gun	752	King	196
Decor	179	Elio	824	Fly	70	Halo	72	King	334
Deep	686	Elisir	200	Fly	260	Halo	270	Klimt	519
Delta	363	Elon	796	Focus	392	Hangar	124	Komodo	401
Denis	378	Elvis	505	Folk	147	Harem	241	Konig	312
Desk	82	Eminent	516	Forcola	528	Harem	440	Konig	640
Desk	364	Eos	632	Fox	624	Haunt	243	Konse	105
Diesis	117	Equinoxe	98	Frame	68	Hermes	328	Kool	368
Diesis	453	Equinoxe	417	Frame	256	Hilton	191	Kuky	133
Diesis	503	Equinoxe	495	Frida	110	Hilton	426	Kurt	793
Disco	104	Eris	126	Frida	411	Hilton	473	Lana	150
Display	642	Essence	80	Funky	714	Hilton	527	Lana	294
Djambé	781	Essence	382	Futura	454	Holiday	430	Landing	841
Dna	170	Etere	747	Futura	507	Holly	118	Lawyer	459
Doc	110	Etere	806	Galileo	710	Hotel	429	Le Roy	486
Doge	233	Eternity	474	Game	672	Hub	787	Leaves	102
Doris	782	Eva	499	Gas	740	Hugo	111	Led Panel	702
Dorsale	512	Evasione	207	Gas	796	Hulahoop	66	Lena	151
Dot	302	Eye	710	Gea	431	Ice	108	Level	282
Double	391	Fade	143	Geko	281	Igor	93	Lido	177
Down	772	Febe	773	Gemini	58	Igor	412	Lika	305
Dream Big	174	Felix	763	Gemma	296	Iguazù	131	Lika	704
Driftwood	243	Fiesta	731	Giada	199	Iko	755	Lingotto	92
Driftwood	478	Filo	78	Gim	405	Impero	227	Lingotto	327
Driftwood	518	Filo	352	Gingle	280	Indio	834	Lingotto	469
Dubai	208	Fiocco	442	Gioconda	226	Inside	828	Link	650
Dubai	341	Firenze	238	Gioconda	437	Io	393	Linus	365
Dubai	433	Firenze	438	Giove	762	Ipotesi	799	Linus	572
Duchessa	485	Firenze	481	Giudecca	221	Itaca	786	Lite	399
Dust	103	Firenze	531	Glim	313	Jazz	714	Litio	739
Dynamic	664	Fish	87	Glim	640	Jedi	801	Litio	825
Dynamite	88	Fisherman	125	Glory	153	Justine	239	Lolita	778
Dynamite	306	Fix	356	Glory	282	Kali	475	London	188
Dynamo	395	Flam	130	Gocce	131	Karma	146	London	471
Echo	366	Flash	369	Goose	394	Karol	258	London	521
Eclissi	423	Flash Gesso	369	Gourmet	324	Karousel	84	Look	74
Edison	111	Flat	276	Grape	166	Kate	484	Look	298
Edison	408	Flood	742	Gravity	840	Kelly	456	Look	371
Edo	465	Floor	837	Gretel	183	Ken	178	Look	641
Edo Outdoor	807	Florian	222	Groove	694	Keope	750	Lord	142

Indice alfabetico

Lounge	714	Mint	180	Ocean	277	Pegaso	487	Relax	278
Lucciola	86	Miramare	236	Octopus	323	Pegaso	530	Retrò	390
Luce Max	158	Mirror-10	389	Off	682	Peggy	355	Rex-1	764
Lugano	109	Mirror-20	391	Office	588	Perlage	96	Rex-2	765
Luna	723	Mix Up	120	Oil	114	Perlage	415	Rex-3	765
Luna	784	Mix Up	288	Olimpia	137	Perlage	466	Rhapsody	85
Luxor	206	Moby	127	Omega R.	736	Perlage	494	Rialto	231
Luxury	428	Monet	211	Omega S.	737	Perline	95	Riflesso	385
Luxury	472	Mood	301	One	678	Peter	439	Ritz	293
Luxury	525	Moonlight	337	Onion	107	Petit	308	Rocket	843
Madame	186	Moris	356	Opera	194	Phoenix	187	Rocket Mini	842
Magnolia	340	Mouse	310	Opera	434	Piano	400	Roma	203
Make Up	385	Mouse	404	Opera	483	Pipe	398	Roma	332
Mama	148	Mouse	638	Opera	529	Pivot	451	Roma	432
Manhattan	138	Mr Jack	113	Oracle	66	Play	307	Roma	482
Mapa Bianco	162	Multiflex	175	Oracle Slim	62	Play	698	Rondo	247
Mapa Bianco	284	Multiflex	322	Oracle Slim	254	Plissé	149	Room-65	715
Mapa Bianco	374	Nabucco	204	Orangerie	247	Polar	767	Rose	217
Mapa Bianco	461	Napoleon	224	Origami	140	Polka	718	Royal	338
Mapa Fade	160	Negresco	218	Orion	197	Polly	510	Rubik	757
Mapa Max	159	Negresco	436	Ovalino	172	Pop	87	Rudy	311
Mapa Max	462	Nemo	168	Ovalino	286	Posta	358	Rudy	405
Mapa Plus	157	Nemo Plus	167	Ovalino	372	Pouche	355	Sailor	128
Mapa Riga	165	Neve	336	Oz	60	Pov	636	Sally	457
Mapa Sat	159	Newton	418	Oz	259	Prato	464	Sally	509
Maracas	315	Newton	504	Oz	350	Pretty	381	Samba	712
Maracas	416	Ninfea	329	Oz	448	Privè	384	Santa	441
Marte	810	Ninfea	421	Page	397	Probe	402	Sasso	785
Martinez	201	Nitro	300	Pagoda	515	Provence	215	Sem	229
Martinez	342	Nodi	171	Pan	89	Pulsar	805	Set Up	192
Medea	767	Nodi	316	Pan	420	Puzzle	357	Set Up	290
Mercurio	810	Nodino	317	Park	838	Quark	681	Set Up	424
Metro	123	Nordik	188	Park Led	839	Queen	486	Set Up	476
Mib	730	Nordik	428	Pashà	205	Queen	530	Set Up	522
Microphone	468	Nordik	472	Pashà	333	Quick	608	Shell	295
Microphone	501	Nordik	524	Pashà	432	Radio	409	Sheraton	430
Milk	134	Norma	246	Path	795	Rain	199	Shower	419
Millennium	210	Nova	700	Paul	372	Rain	339	Simply	294
Minimal	112	Oak	76	Pauline	102	Rain	482	Sirio	790
Minimal	410	Oak	304	Pauline	321	Read	402	Sky	77
Minimal	500	Oby	311	Pegaso	212	Reflex	360	Sky	299
Minor	73	Oby	406	Pegaso	435	Regol	520	Sky	370

Slem	314	Terra	826	Vision	592
Slem	407	Tesi	590	V-Line	81
Slot	598	Tesla	794	Vortex	103
Smarties	152	Tetris-1	758	Walky	719
Smarties	283	Tetris-2	759	Wally	457
Smarties	375	Thor	818	Wally	508
Smarties	460	Tick	422	Way	843
Smile	616	Tiepolo	219	Wheel	190
Snell	479	Tifone	798	Wheel	293
Snif Round	748	Titano	792	Winery	309
Snif Square	749	Toby	307	Winery	408
Soda	373	Tolomeo	145	Wire	833
Soft	176	Torre	808	Woody	190
Sole	722	Totem	279	Woody	292
Sole	783	Tower	304	Woody	427
Soul	717	Triade	119	Xeno	728
Spark	101	Triplo	376	Xeno	741
Spark	324	Tristan	136	Yoko	81
Spike	303	Triumph	90	Yoko	452
Spot	310	Triumph	318	Yoko	498
Spot	404	Triumph	416	York	519
Spot	638	Tronco	746	Yurta	122
Stage	511	Tronco	802	Zenith	829
Stardust	779	Truman	458	Zephyr	711
Starlight	820	Tube	76	Zig Zag	367
Steel	584	Tudor	379	Ziggy	287
Strauss	230	Twin	760		
Strauss	437	Ulex	822		
Style	744	Ulisse	154		
Style	789	Ultrathin	79		
Sun	780	Umile	141		
Sunglasses	728	Universal R.	272		
Sunrise	421	Universal S.	274		
Swan	195	Up	756		
Swan	434	Up And Down	129		
Swing	714	Urano	729		
Swipe	743	Vanity	240		
Syntesi	353	Vega	800		
Tall	116	Venus	805		
Taurus	836	Versus	198		
Techo	726	Virtus	361		
Terra	740	Virus	680		

Gourmet

Pag 324

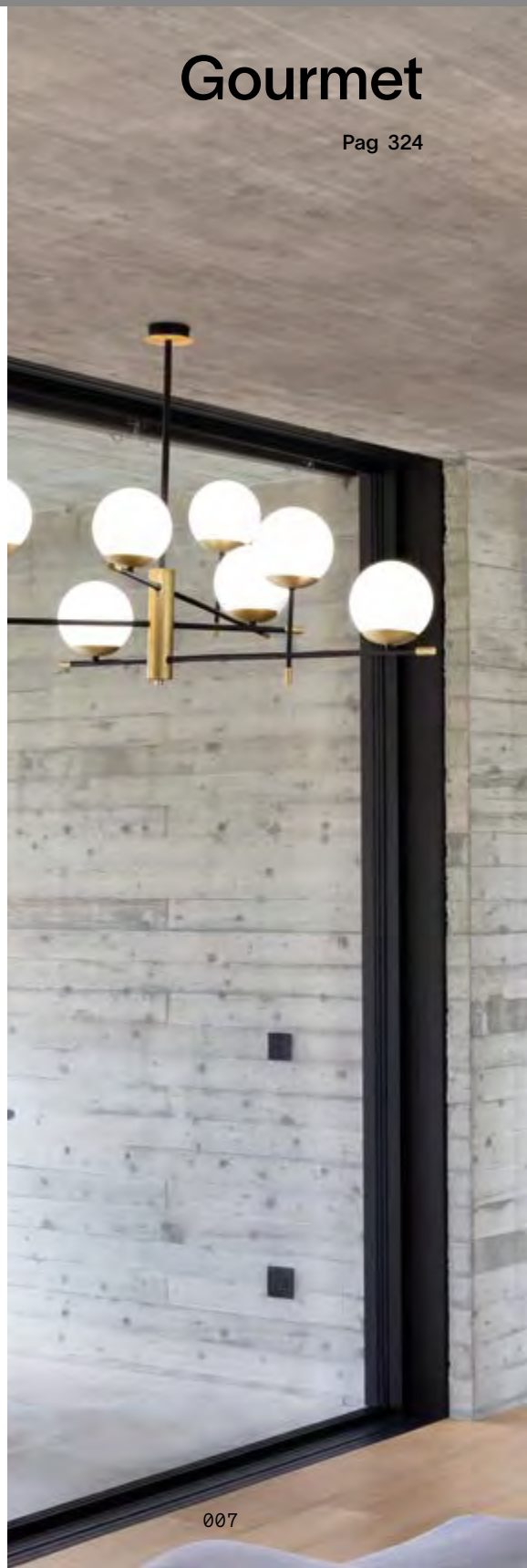

















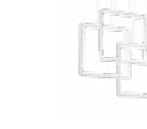



























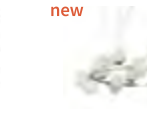
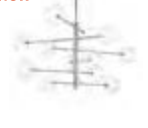



Circus

Pag 067



























































Indice icone

Interni Sospensioni

<small>new</small> 	<small>new</small> 	<small>new</small> 			<small>new</small> 	
Gemini 058	Oz 060	Oracle Slim 062	Oracle 066	Hulahoop 066	Circus 067	Frame 068
<small>new</small> 						
Fly 070	Halo 072	Minor 073	Look 074	Tube 076	Oak 076	Sky 077
						<small>new</small> 
Filo 078	Ultrathin 079	Essence 080	Yoko 081	V-Line 081	Desk 082	Craft 083
		<small>new</small> 				
Karousel 084	Rhapsody 085	Lucciola 086	Fish 087	Pop 087	Dynamite 088	Pan 089
					<small>new</small> 	<small>new</small> 
Triumph 090	Abc 091	Lingotto 092	Igor 093	Birds 094	Perline 095	Perlage 096
<small>new</small> 						
Equinoxe 098	Copernico 100	Kepler 101	Spark 101	Leaves 102	Pauline 102	Vortex 103
						
Dust 103	Disco 104	Konse 105	Ampolla 106	Onion 107	Ice 108	Citrus 109

Interni

Sospensioni

						
Lugano 109	Frida 110	Doc 110	Edison 111	Hugo 111	Minimal 112	Mr Jack 113
						
Diesis 117	Holly 118	Triade 119	Mix Up 120	Yurta 122	Metro 123	Breeze 123
						
Moby 127	Sailor 128	Cantina 129	UpandDown 129	Flam 130	Iguazù 131	Gocce 131
						
Cocktail 135	Tristan 136	Olimpia 137	Manhattan 138	Flut 139	Origami 140	Umile 141
						
Audi-20 144	Tolomeo 145	Karma 146	Folk 147	Aria 148	Mama 148	Plissé 149
						
Glory 153	Ulisse 154	Arizona 154	Candy 155	Clown 156	Bollicine 157	Mapa Plus 157
						
Mapa Fade 160	MapaBianco 162	Carta 164	Boa 165	Mapa Riga 165	Grape 166	Nemo Plus 167
						
Ovalino 172	Basket 173	Dream Big 174	Avion 175	Multiflex 175	Soft 176	Lido 177



Oil 114



Tall 116



A-Line 116



Hangar 124



Fisherman 125



Eris 126



Cono 132



Kuky 133



Milk 134



Blossom 142



Lord 142



Fade 143



Lana 150



Lena 151



Smarties 152



Luce Max 158



Mapa Sat 159



Mapa Max 159



Nemo 168



Dna 170

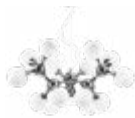

Nodi 171



Ken 178



Coco 178



new

Decor 179



Decor

Pag 179



Audi-10

Pag 184



Mint 180



Bergen 181



Bistrò 182



Cylinder 189



Cloe 189



Woody 190



Orion 197



Versus 198



Rain 199



Luxor 206



Evasione 207



Audi-77 207



Colossal 216



Rose 217



Negresco 218



Corte 228



Sem 229



Strauss 230



Firenze 238



Justine 239



Vanity 240

Interni

Sospensioni



Gretel 183



Audi-10 184



Audi-80 185



Madame 186



Phoenix 187



London 188



Nordik 188



Wheel 190



Hilton 191



Set Up 192



Opera 194



Swan 195



Calypso 196



King 196



Giada 199



Elisir 200



Martinez 201



Carlton 202



Roma 203



Nabucco 204



Pashà 205



Dubai 208



Caesar 209



Millennium 210



Monet 211



Pegaso 212



Blanche 214



Provence 215



Tiepolo 219



Amadeus 220



Giudecca 221



Florian 222



Napoleon 224



Gioconda 226



Impero 227



Rialto 231



Casanova 232



Doge 233



Danieli 234



Brigitta 235



Miramare 236



Bon Bon 237



Harem 241



Chalet 242



Haunt 243



Driftwood 243



Canapa 244



Electric 245



Norma 246



Deca 246



























































Orangerie 247



Rondo 247

Interni

Lampade da soffitto

			 new	 new		
Oracle Slim 254	Frame 256	Karol 258	Oz 259	Fly 260	Halo 270	Universal R. 272
	 new					
Universal S. 274	Clara 276	Flat 276	Celine 277	Ocean 277	Relax 278	Totem 279
						
Gingle 280	Geko 281	Glory 282	Level 282	Smarties 283	Arizona 284	MapaBianco 284
			 new	 new	 new	
Candy 285	Ovalino 286	Cloud 286	Ziggy 287	Mix Up 288	Set Up 290	Woody 292
						 new
Wheel 293	Ritz 293	Simply 294	Lana 294	Shell 295	Gemma 296	Aura 297
				 new		
Look 298	Sky 299	Nitro 300	Mood 301	Dot 302	Spike 303	Oak 304
						
Tower 304	Lika 305	Dynamite 306	Play 307	Toby 307	Petit 308	Winery 309
				 new		
Mouse 310	Spot 310	Rudy 311	Oby 311	Konig 312	Glim 313	Alfa 314

Aura

Pag 297













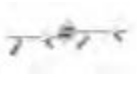



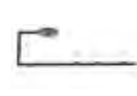

















Ninfea

Pag 329



Interni

Lampade da soffitto

						
Slem 314	Maracas 315	Nodi 316	Nodino 317	Triumph 318	Birds 319	Dea 320
				<small>new</small> 		<small>new</small> 
Pauline 321	Multiflex 322	Octopus 323	Spark 324	Gourmet 324	Cosmopolitan 325	Angolo 326
	<small>new</small> 	<small>new</small> 				
Lingotto 327	Hermes 328	Ninfea 329	Almond 330	Daisy 330	Compo 331	Roma 332
						
Pashà 333	King 334	Admiral 335	Neve 336	Moonlight 337	Royal 338	Bijoux 338
						
Rain 339	Magnolia 340	Dubai 341	Caesar 341	Martinez 342	Carlton 343	

Zig Zag

Pag 367



new



Oz 350

new



Filo 352



Box 357



Posta 358



Desk 364

new



Craft 364



Look 371



Paul 372



Tudor 379



Camerino 380



Bow 388



Mirror-10 389



Bean 396



Page 397



























































Mouse 404



Spot 404







































Interni

Lampade da parete

						
Syntesi 353	Cover 354	Peggy 355	Pouche 355	Fix 356	Moris 356	Puzzle 357
		<i>new</i> 				<i>new</i> 
Clip 359	Cube 360	Reflex 360	Virtus 361	Click 361	Bright 362	Delta 363
		<i>new</i> 				
Linus 365	Echo 366	Zig Zag 367	Kool 368	Flash 369	FlashGesso 369	Sky 370
						
Ovalino 372	Soda 373	MapaBianco 374	Smarties 375	Triplo 376	Ali 377	Denis 378
<i>new</i> 			<i>new</i> 			
Pretty 381	Essence 382	Privè 384	Make Up 385	Riflesso 385	Alma 386	Bonjour 387
						
Retrò 390	Mirror-20 391	Double 391	Focus 392	IO 393	Goose 394	Dynamo 395
		<i>new</i> 	<i>new</i> 			
Pipe 398	Lite 399	Piano 400	Komodo 401	Probe 402	Read 402	Book 403
						
Gim 405	Rudy 405	Oby 406	Barber 406	Alfa 407	Slem 407	Winery 408

Interni

Lampade da parete

						
Edison 408	Radio 409	Minimal 410	Frida 411	Igor 412	Birds 413	Kepler 414
						
Maracas 416	Equinoxe 417	Cantina 418	Newton 418	Shower 419	Pan 420	Sunrise 421
						
Eclissi 423	Set Up 424	Hilton 426	Woody 427	Luxury 428	Nordik 428	Hotel 429
						
Gea 431	Calypso 432	Roma 432	Pashà 432	Carlton 433	Dubai 433	Opera 434
						
Corte 435	Negresco 436	Florian 436	Gioconda 437	Strauss 437	Firenze 438	Chalet 438
						
Santa 441	Fiocco 442	Carrara 443				

new



Perlage 415



Triumph 416

new



Ninfea 421



Tick 422



Holiday 430



Sheraton 430



Swan 434



Pegaso 435



Peter 439



Harem 440



Piano

Pag 400















































Angolo

Pag 467



Interni

Lampade da tavolo

		new 		new 		
Oz 448	Gru 450	Pivot 451	Yoko 452	Diesis 453	Futura 454	Kelly 456
						
Sally 457	Wally 457	Truman 458	Lawyer 459	Smarties 460	Candy 460	MapaBianco 461
					new 	new 
Mapa Max 462	Birillo 463	Prato 464	Edo 465	Birds 466	Perlage 466	Angolo 467
						
Microphone 468	Lingotto 469	Axel 470	London 471	Nordik 472	Luxury 472	Hilton 473
						
Alfiere 474	Eternity 474	Kali 475	Set Up 476	Driftwood 478	Snell 479	Chalet 480
						
Firenze 481	Roma 482	Rain 482	Opera 483	Kate 484	Duchessa 485	Queen 486
						
					Le Roy 486	Pegaso 487

Interni

Lampade da terra



new

Birds 492



Perlage 494



new

Equinoxe 495



new

Angolo 496



new

Audio 497



Yoko 498



new

Eva 499



Newton 504



Elvis 505



new

Comfort 506



Futura 507



Wally 508



Sally 509



Polly 510



Pagoda 515



Eminent 516



Axel 517



Driftwood 518



York 519



Klimt 519



Nordik 524



Luxury 525



Colonna 526



Hilton 527



Forcola 528



Opera 529



Queen 530

Eva

Pag 499



Minimal 500



Microphone 501

new



Craft 502



Diesis 503



Stage 511



Dorsale 512



Daddy 514



Regol 520



London 521



Set Up 522



Cylinder 524



Pegaso 530



Firenze 531



Slot

Pag 598



Sistemi

new



Arca 534

new



Ego 548



Linus 572



Fluo 574



Steel 584



Office 588

new



Tesi 590



Vision 592



Slot 598

Proiettori e binari



Quick 608



Smile 616

new



Fox 624

new



Eos 632

new



Pov 636



Mouse 638



Spot 638

new



Byte 639



Glim 640

new



Konig 640



Look 641































Display 642



Link 650

Interni

Lampade da incasso

				
Bento 658	Dynamic 664	Game 672	One 678	Virus 680
				
Quark 681	Off 682	Deep 686	Basic 688	Groove 694
				
Play 698	Channel 699	Nova 700	Led Panel 702	Lika 704
<small>new</small> 				
Galileo 710	Eye 710	Zephyr 711	Samba 712	Jazz 714
				
Swing 714	Lounge 714	Funky 714	Room-65 715	Blues 716
				
	Soul 717	Soul 717	Polka 718	Walky 719

Fiesta

Pag 731

Sospensioni e soffitto



Sole 722



Luna 723



Clio 724



Clio 724



Clio 724



Clio 724



Clio 724



Clio 724



Techo 726



Gun 727



Sunglasses 728



Xeno 728



Urano 729



Bubble 730













































Mib 730



Fiesta 731

Esterni

Lampade da parete

						
Omega R. 736	Omega S. 737	Elio 738	Litio 739	Terra 740	Gas 740	Xeno 741
						
Flood 742	Swipe 743	Style 744	Tronco 746	Etere 747	Snif Round 748	Snif Square 749
						
Keope 750	Apollo 751	Gun 752	Base 754	Iko 755	Up 756	Rubik 757
						
Tetris-1 758	Tetris-2 759	Argo 759	Twin 760	Andromeda 761	Giove 762	Felix 763
						
Rex-1 764	Rex-2 765	Rex-3 765	Cometa 766	Polar 767	Medea 767	Bubble 768
						
Clio 769	Clio 769	Clio 769	Cima 770	Dafne 771	Down 772	Febe 773

Esterni

Bollard e lampade da tavolo

 new		 new	 new			
Lolita 778	Stardust 779	Sun 780	Djambe 781	Doris 782	Sole 783	Luna 784
						
Sasso 785	Itaca 786	Hub 787	Agos 788	Style 789	Sirio 790	Titano 792
 new				 new		
Kurt 793	Tesla 794	Path 795	Gas 796	Elon 796	Acqua 797	Tifone 798
 new		 new				
Ipotesi 799	Vega 800	Jedi 801	Tronco 802	Atena 804	Pulsar 805	Venus 805
						
Etere 806	Edo Outdoor 807	Torre 808	Cosmo 809	Marte 810	Mercurio 810	Classic Globe 811
						
Clio 812	Clio 812	Clio 812	Cima 814	Dafne 815		

Proiettori



Thor 818



Starlight 820



Ulex 822



Elio 824



Litio 825



Terra 826



Inside 828



Zenith 829

Incassi



Bit 832



Wire 833



Indio 834



Avenue 835



Taurus 836



Floor 837



Park 838



Park Led 839



Gravity 840



Landing 841



RocketMini 842



Rocket 843



Way 843

Jedi

Pag 801



“C'è un gesto quotidiano
che ognuno di noi compie
al sopraggiungere del buio.
Un rito familiare che
rappresenta gioia, sicurezza,
momento dedicato allo
stare insieme.

**Accendere una luce è
un'azione semplice,
ma carica di significati.
Da qui inizia la nostra storia.”**



ideal lux



Light up your moments

Ideal lux **si impegna ogni giorno per diventare** il punto di riferimento nella scelta di una lampada che esprima la propria personalità attraverso un complemento d'arredo unico e attuale.

Tutto nasce nel 1974, dall'intuizione di ideare complementi d'arredo illuminotecnici attuali e accessibili. Da allora, ideal lux si impegna ad ascoltare le necessità di tutti, proponendo un'ampissima varietà di stili di illuminazione e **venendo incontro** a ogni esigenza funzionale. Che sia una famiglia, un'attività commerciale o una persona all'inizio

della sua avventura in una nuova casa, ideal lux promette **componenti all'altezza di esigenze e sogni.**

Il punto di forza, irrinunciabile quando si parla di vicinanza tra azienda e persone, è un catalogo che va incontro a qualunque tipo di esigenza: **più di 3.000 complementi d'arredo** che spaziano tra tantissime linee prodotte, dai complementi da interno ed esterno, fino ad arrivare a quelli più tecnici.



Giving shape to light

Quando si parla di soluzioni da interno, l'obiettivo di ideal lux è quello di **creare scenografie** versatili per tutti gli ambienti, lasciando **vivere ogni momento** con la giusta atmosfera e offrendo a tutti la possibilità di **sperimentare con la propria idea di casa**. Anche fuori, le soluzioni proposte per gli spazi esterni non rinunciano a estetica e sicurezza, restando un piacevole **elemento di design** anche nei momenti in cui si ha bisogno di un po' d'aria.

Per gli spazi professionali, che richiedono un'**attenzione tecnica particolare**, ideal lux ha pensato di lavorare su tantissime proposte che aiutano a distribuire la luce nella giusta direzione dando maggiore

resa ai colori, senza mai perdere di vista il design e **rendendo unici** anche gli spazi in cui si creano relazioni professionali.

Ma se da una parte garantire la scelta e proporre un catalogo vasto costituisce un obiettivo commerciale molto importante, dall'altra, anche **la relazione con i clienti** è un aspetto che ideal lux coltiva con meticolosa cura. Come lo fa? Assicurando la possibilità di acquistare un prodotto di design, aggiornato alle tendenze più attuali e, soprattutto, accessibile a tutti. Che lo stile preferito sia industrial, minimal, classico, contemporaneo, moderno o eclettico... chiunque lo desideri può **entrare nel mondo ideal lux**.

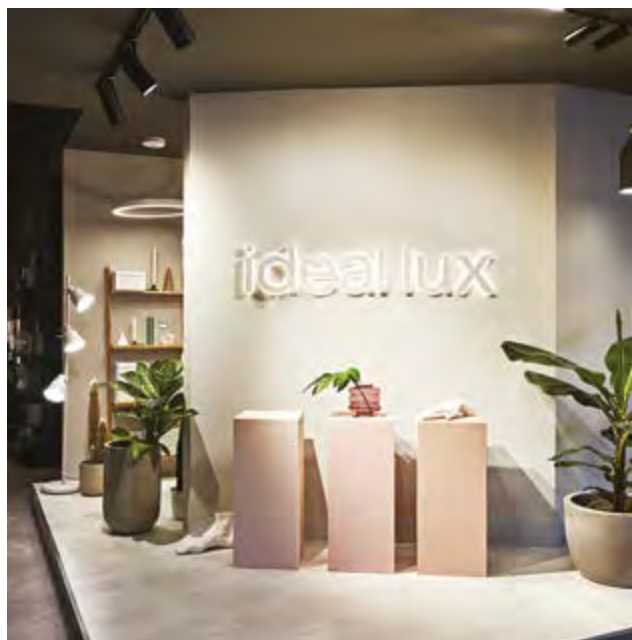









Studio Impero
Rome, RM
Planned out by ARCH.0



Studio Impero
Rome, RM
Planned out by ARCH.0

Per ideal lux una lampada è molto più di un oggetto. L'illuminazione ha il potere di **influenzare la quotidianità**, donando **carattere e personalità uniche agli ambienti**. Per questo, ogni giorno ideal lux si impegna ad ascoltare le persone e le loro storie, con l'obiettivo di coltivare un **rapporto autentico e spontaneo**, e trovando nel racconto nuovi punti di vista, nuove ispirazioni.

Il **Customer Care** costituisce un ramo importante dell'azienda, distinguendosi per la cura e per l'attenzione che dedica ai clienti e facendo dell'affidabilità

uno dei principi più importanti. **L'attenzione per le persone è centrale**. Con ideal lux la luce diventa quell'elemento della quotidianità capace di **trasformare l'ordinario in straordinario**. Perché accada, è importante scegliere l'illuminazione adatta alle proprie esigenze, perché con la luce giusta ogni ambiente può assumere **tutta un'altra forma, un'altra storia**.

The ordinary is extraordinary

Un brand, tante persone.

Crederci nelle persone è una scelta che facciamo ogni giorno. Valorizziamo i dipendenti, crescendo giorno dopo giorno assieme a loro, e costruiamo relazioni durature e trasparenti con clienti e fornitori.

Il design alla portata di tutti.

Vogliamo far entrare il design nella quotidianità delle persone, con soluzioni luminose esteticamente belle e funzionali, ma a costi contenuti.

Saper ascoltare.

Ci impegniamo a comprendere le necessità e i sogni dei clienti e a trasformare le difficoltà in occasioni, con l'obiettivo di migliorare costantemente in questa direzione.

Non c'è qualità senza garanzia.

Abbiamo esteso la garanzia di tutti i nostri complementi illuminotecnici a 5 anni, per assicurare in ogni momento una qualità elevata di prodotto e servizio.

Un brand,
tante persone.

Saper
ascoltare.

Non c'è
qualità senza
garanzia.

Il design
alla portata
di tutti.

Cliente



Your projects,

Projects — Private house

Rome, Italy

Planned out by
Iterno 16 Architettura

Products:
Madame, Bubble, Winery.





our products.

Projects — Private house

Rome, Italy

Planned out by
Arch. Luca Caprioli

Products:
Ultrathin, Look, Nemo.



Projects — Coffee bar & bakery

Caffe
Muscari

Milan, Italy

Products:
Ice



Projects — Restaurant

Restaurant
Bati

Teramo, Italy

Products:
Lolita, Ego





Interni

Sospensioni

Indice alfabetico

Abc	91	Circus	67	Essence	80
A-Line	116	Citrus	109	Evasione	207
Amadeus	220	Cloe	189	Fade	143
Ampolla	106	Clown	156	Filo	78
Aria	148	Cocktail	135	Firenze	238
Arizona	154	Coco	178	Fish	87
Audi-10	184	Colossal	216	Fisherman	125
Audi-20	144	Cono	132	Flam	130
Audi-77	207	Copernico	100	Florian	222
Audi-80	185	Corte	228	Flut	139
Avion	175	Craft	83	Fly	70
Basket	173	Cylinder	189	Folk	147
Bergen	181	Danieli	234	Frame	68
Birds	94	Deca	246	Frida	110
Bistrò	182	Decor	179	Gemini	58
Blanche	214	Desk	82	Giada	199
Blossom	142	Diesis	117	Gioconda	226
Boa	165	Disco	104	Giudecca	221
Bollicine	157	Dna	170	Glory	153
Bon Bon	237	Doc	110	Gocce	131
Breeze	123	Doge	233	Grape	166
Brigitta	235	Dream Big	174	Gretel	183
Caesar	209	Driftwood	243	Halo	72
Calypso	196	Dubai	208	Hangar	124
Canapa	244	Dust	103	Harem	241
Candy	155	Dynamite	88	Haunt	243
Cantina	129	Edison	111	Hilton	191
Carlton	202	Electric	245	Holly	118
Carta	164	Elisir	200	Hugo	111
Casanova	232	Equinoxe	98	Hulahoop	66
Chalet	242	Eris	126	Ice	108



Indice alfabetico

















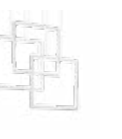































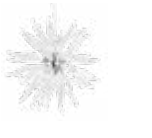





Igor	93	Mr Jack	113	Soft	176
Iguazù	131	Multiflex	175	Spark	101
Impero	227	Nabucco	204	Strauss	230
Justine	239	Napoleon	224	Swan	195
Karma	146	Negresco	218	Tall	116
Karousel	84	Nemo	168	Tiepolo	219
Ken	178	Nemo Plus	167	Tolomeo	145
Kepler	101	Nodi	171	Triade	119
King	196	Nordik	188	Tristan	136
Konse	105	Norma	246	Triumph	90
Kuky	133	Oak	76	Tube	76
Lana	150	Oil	114	Ulisse	154
Leaves	102	Olimpia	137	Ultrathin	79
Lena	151	Onion	107	Umile	141
Lido	177	Opera	194	Up And Down	129
Lingotto	92	Oracle	66	Vanity	240
London	188	Oracle Slim	62	Versus	198
Look	74	Orangerie	247	V-Line	81
Lord	142	Origami	140	Vortex	103
Lucciola	86	Orion	197	Wheel	190
Luce Max	158	Ovalino	172	Woody	190
Lugano	109	Oz	60	Yoko	81
Luxor	206	Pan	89	Yurta	122
Madame	186	Pashà	205		
Mama	148	Pauline	102		
Manhattan	138	Pegaso	212		
Mapa Bianco	162	Perlage	96		
Mapa Fade	160	Perline	95		
Mapa Max	159	Phoenix	187		
Mapa Plus	157	Plissé	149		
Mapa Riga	165	Pop	87		
Mapa Sat	159	Provence	215		
Martinez	201	Rain	199		
Metro	123	Rhapsody	85		
Milk	134	Rialto	231		
Millennium	210	Roma	203		
Minimal	112	Rondo	247		
Minor	73	Rose	217		
Mint	180	Sailor	128		
Miramare	236	Sem	229		
Mix Up	120	Set Up	192		
Moby	127	Sky	77		
Monet	211	Smarties	152		

Oracle Slim

Pag 062

























































Interni

Indice icone

<small>new</small> 	<small>new</small> 	<small>new</small> 			<small>new</small> 	
Gemini 058	Oz 060	OracleSlim 062	Oracle 066	Hulahoop 066	Circus 067	Frame 068
<small>new</small> 						
Fly 070	Halo 072	Minor 073	Look 074	Tube 076	Oak 076	Sky 077
						<small>new</small> 
Filo 078	Ultrathin 079	Essence 080	Yoko 081	V-Line 081	Desk 082	Craft 083
		<small>new</small> 				
Karousel 084	Rhapsody 085	Lucciola 086	Fish 087	Pop 087	Dynamite 088	Pan 089
					<small>new</small> 	<small>new</small> 
Triumph 090	Abc 091	Lingotto 092	Igor 093	Birds 094	Perline 095	Perlage 096
<small>new</small> 		<small>new</small> 				
Equinoxe 098	Copernico 100	Kepler 101	Spark 101	Leaves 102	Pauline 102	Vortex 103
						
Dust 103	Disco 104	Konse 105	Ampolla 106	Onion 107	Ice 108	Citrus 109
						
Lugano 109	Frida 110	Doc 110	Edison 111	Hugo 111	Minimal 112	Mr Jack 113

Interni

Indice icone

						
Oil 114	Tall 116	A-Line 116	Diesis 117	Holly 118	Triade 119	Mix Up 120
						
Hangar 124	Fisherman 125	Eris 126	Moby 127	Sailor 128	Cantina 129	UpandDown 129
						
Cono 132	Kuky 133	Milk 134	Cocktail 135	Tristan 136	Olimpia 137	Manhattan 138
						
Blossom 142	Lord 142	Fade 143	Audi-20 144	Tolomeo 145	Karma 146	Folk 147
						
Lana 150	Lena 151	Smarties 152	Glory 153	Ulisse 154	Arizona 154	Candy 155
						
Luce Max 158	Mapa Sat 159	Mapa Max 159	Mapa Fade 160	MapaBianco 162	Carta 164	Boa 165
						
Nemo 168	Dna 170	Nodi 171	Ovalino 172	Basket 173	Dream Big 174	Avion 175
						
Ken 178	Coco 178	Decor 179	Mint 180	Bergen 181	Bistrò 182	Gretel 183



Yurta 122



Metro 123



Breeze 123



Flam 130



Iguazù 131



Gocce 131



Flut 139



Origami 140



Umile 141



Aria 148



Mama 148



Plissé 149



Clown 156



Bollicine 157



Mapa Plus 157



Mapa Riga 165



Grape 166



Nemo Plus 167



Multiflex 175



Soft 176



Lido 177



Audi-10 184



Audi-80 185



Madame 186



Mix Up

Pag 120



Phoenix 187



London 188



Nordik 188



Swan 195



Calypso 196



King 196



Roma 203



Nabucco 204



Pashà 205



Pegaso 212



Blanche 214



Provence 215



Napoleon 224



Gioconda 226



Impero 227



Brigitta 235



Miramare 236



Bon Bon 237

Pashà

Pag 205

Interni

Indice icone



Cylinder 189



Cloe 189



Woody 190



Wheel 190



Hilton 191



Set Up 192



Opera 194



Orion 197



Versus 198



Rain 199



Giada 199



Elisir 200



Martinez 201



Carlton 202



Luxor 206



Evasione 207



Audi-77 207



Dubai 208



Caesar 209



Millennium 210



Monet 211



Colossal 216



Rose 217



Negresco 218



Tiepolo 219



Amadeus 220



Giudecca 221



Florian 222



Corte 228



Sem 229



Strauss 230



Rialto 231



Casanova 232

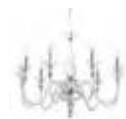

Doge 233



Danieli 234



Firenze 238



Justine 239



Vanity 240



Harem 241



Chalet 242



Haunt 243



Driftwood 243



Canapa 244



Electric 245



Norma 246



Deca 246



Orangerie 247



Rondo 247



Gemini **new**

Rosone e paralume in metallo verniciato a polveri o placcato. Diffusore in policarbonato opale. Cavo in pvc trasparente. Finiture: bianco, nero o ottone spazzolato.

LED Sorgente luminosa LED 3000 K, 50.000 h di durata.

<p>247229</p>	<p>247236</p>	<p>247243</p>	<p>247243</p>
<p>75</p> <p>35</p> <p>1050</p> <p>2050</p> <p>995</p>	<p>75</p> <p>35</p> <p>810</p> <p>1800</p> <p>810</p>	<p>75</p> <p>35</p> <p>610</p> <p>1515</p> <p>610</p>	<p>75</p> <p>35</p> <p>425</p> <p>1525</p> <p>425</p>
<p>IP20</p> <p>3,100 Kg / 0,1134 m³</p> <p>LED 80W / 10000 lm</p> <p>€ 650</p>	<p>IP20</p> <p>2,060 Kg / 0,0774 m³</p> <p>LED 60W / 8100 lm</p> <p>€ 430</p>	<p>IP20</p> <p>1,710 Kg / 0,0462 m³</p> <p>LED 48W / 6600 lm</p> <p>€ 330</p>	<p>IP20</p> <p>1,290 Kg / 0,0230 m³</p> <p>LED 38W / 5100 lm</p> <p>€ 240</p>
<p>303895 Bianco</p> <p>307695 Nero</p> <p>307701 Ottone</p>	<p>new 247274 Bianco</p> <p>new 247281 Nero</p> <p>new 269849 Ottone</p>	<p>247250 Bianco</p> <p>247267 Nero</p> <p>269832 Ottone</p>	<p>247229 Bianco</p> <p>247236 Nero</p> <p>247243 Ottone</p>



Oz new

Base e montatura in metallo verniciato a polveri o placcato. Cavi in pvc. Diffusore in gomma opale. Finiture: bianco, nero o ottone spazzolato. Disponibile anche in versione dimmerabile DALI/Push.

LED Sorgente luminosa LED 3000 K, 30.000 h di durata.

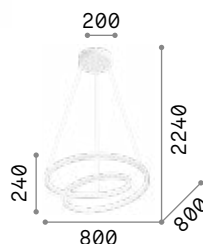

IP20

1,920 Kg / 0,1215 m³
LED 55W / 6100 lm

€ 390 On-Off / 500 Dali

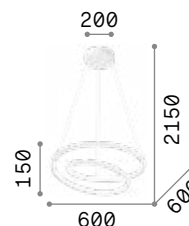

IP20

1,630 Kg / 0,0676 m³
LED 48W / 5300 lm

€ 325 On-Off / 415 Dali

253664	Bianco	On-Off	253671	Bianco	On-Off
304571	Bianco	Dali/Push ^{new}	304540	Bianco	Dali/Push ^{new}
269450	Nero	On-Off	269436	Nero	On-Off
304588	Nero	Dali/Push ^{new}	304557	Nero	Dali/Push ^{new}
269467	Ottone	On-Off	269443	Ottone	On-Off
304595	Ottone	Dali/Push ^{new}	304564	Ottone	Dali/Push ^{new}

Oracle Slim Round new

Lampada a sospensione costituita da una montatura sottile in alluminio verniciato bianco o nero opaco e diffusore opale in policarbonato. Disponibile in quattro dimensioni diverse. LED integrati, disponibile in temperatura di colore 3000 K e 4000 K e con controllo ON-OFF oppure dimmerabile DALI/Push, CRI ≥ 80, durata utile LED 20.000 h, protezione IP20, classe isolamento II.

Sorgente	LED SMD	Durata LED	20.000 h
Potenza	32W / 89W	Classe	II
Driver incluso	On/Off / DALI/Push	isolamento	
Driver disponibili	No	IP	20
Angolo	115°	Materiale	Alluminio
CCT	3000 K / 4000 K		
CRI	≥80		

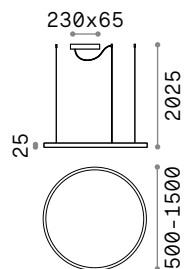

LED SMD Driver incluso

Dimensioni	Peso	Volume	Potenza	Driver	Lumen	CCT	Finitura	Codice	€	
ø 500	32 W	1,400 Kg	0,0376 m³	On-Off	3150 lm	3000 K	Bianco	229461	200	
						3000 K	Nero	229492	200	
						3350 lm	4000 K	Bianco	269856	200
						4000 K	Nero	304380	200 new	
ø 700	29 W	1,100 Kg	0,0272 m³	DALI/Push	3000 lm	3000 K	Bianco	304373	250 new	
						3000 K	Nero	304366	250 new	
						4300 lm	3000 K	Bianco	229485	245
							3000 K	Nero	229515	245
ø 900	39 W	1,200 Kg	0,0534 m³	DALI/Push	4150 lm	4000 K	Bianco	269863	245	
						4000 K	Nero	304410	245 new	
						5700 lm	3000 K	Bianco	304403	300 new
							3000 K	Nero	304397	300 new
ø 1500	55 W	1,800 Kg	0,2212 m³	On-Off	5400 lm	3000 K	Bianco	229478	300	
						3000 K	Nero	229508	300	
						4600 lm	4000 K	Bianco	269870	300
							4000 K	Nero	304441	300 new
ø 1500	43 W	1,500 Kg	0,0857 m³	DALI/Push	4600 lm	3000 K	Bianco	304434	360 new	
						3000 K	Nero	304427	360 new	
						9650 lm	3000 K	Bianco	265957	490
							3000 K	Nero	285061	490
ø 1500	89 W	2,480 Kg	0,4096 m³	On-Off	9000 lm	4000 K	Bianco	285078	490	
						4000 K	Nero	304472	490 new	
						7050 lm	3000 K	Bianco	304465	600 new
							3000 K	Nero	304458	600 new

Lunghezza cavo 2500 mm





Oracle Slim Square

Lampada a sospensione costituita da una montatura sottile in alluminio verniciato bianco o nero opaco e diffusore opale in policarbonato. Disponibile in tre dimensioni diverse. LED integrati, disponibile in temperatura di colore 3000 K e con controllo ON-OFF, CRI ≥ 80, durata utile LED 20.000 h, protezione IP20, classe isolamento II.

Sorgente	LED SMD	Durata LED	20.000 h
Potenza	33W / 53W	Classe	II
Driver incluso	On/Off	isolamento	
Driver disponibili	No	IP	20
Angolo	115°	Materiale	Alluminio
CCT	3000 K		
CRI	≥80		



LED SMD Driver ON/OFF incluso

Dimensioni	Peso	Volume	Potenza	Driver	Lumen	CCT	Finitura	Codice	€
500x500	1,730 Kg	0,0422 m³	33 W	On-Off	3300 lm	3000 K	Bianco	259154	210
							Nero	259161	210
700x700	2,000 Kg	0,0819 m³	41 W	On-Off	4350 lm	3000 K	Bianco	259178	255
							Nero	259185	255
900x900	2,100 Kg	0,1317 m³	53 W	On-Off	5250 lm	3000 K	Bianco	259192	310
							Nero	259208	310

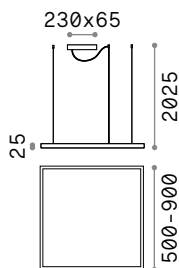

Lunghezza cavo 2500 mm



Oracle

Rosone e corpo luce in alluminio verniciato a polveri di colore bianco o nero. Diffusore in materiale plastico color opale. Sorgente luminosa a led integrati.

LED Sorgente luminosa LED 3000 K, 30.000 h di durata.

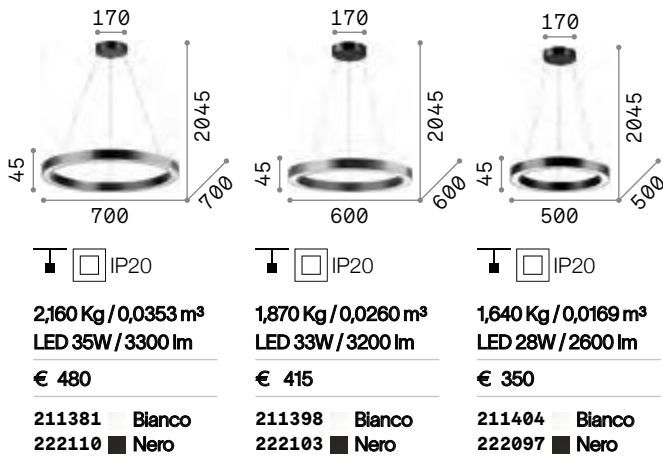

Hulahoop

Rosone e montatura in metallo verniciato a polveri con finitura bianca. Diffusore in gomma opale. Cavi in acciaio con supporti a soffitto. Cavo elettrico in pvc trasparente.

LED Sorgente luminosa LED 3000 K, 17.500 h di durata.

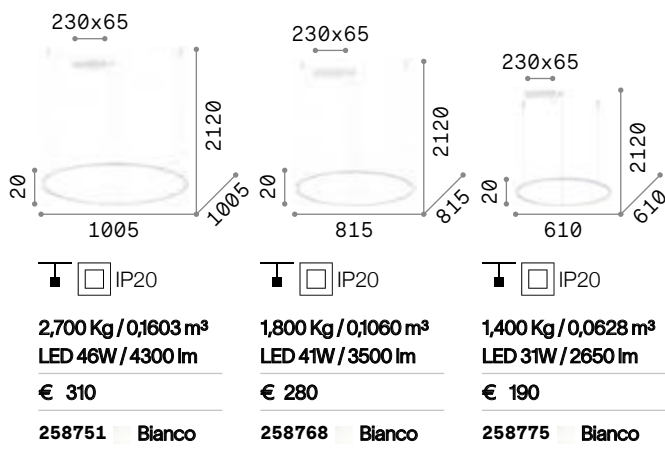



Circus **new**

Rosone e montatura in metallo verniciato a polveri. Diffusore esterno in policarbonato opale. Cavo elettrico in PVC. Finiture: bianco oppure nero.

LED Sorgente luminosa LED 3000 K, 20.000 h di durata.



291338



291345

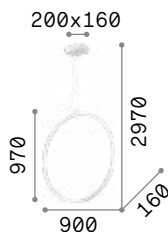

IP20

1,190 Kg / 0,0846 m³
LED 40W / 4850 lm

€ 330

291420 **Bianco** **new**
291437 **Nero** **new**

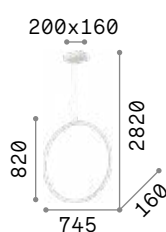

IP20

1,130 Kg / 0,0593 m³
LED 36W / 4250 lm

€ 290

291390 **Bianco** **new**
291406 **Nero** **new**

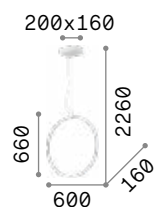

IP20

1,060 Kg / 0,0384 m³
LED 33W / 3550 lm

€ 255

291369 **Bianco** **new**
291376 **Nero** **new**

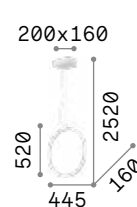

IP20

0,970 Kg / 0,0221 m³
LED 29W / 3250 lm

€ 220

291338 **Bianco** **new**
291345 **Nero** **new**



Frame

Base e montatura in metallo verniciato bianco opaco o nero opaco. Diffusori in materiale plastico colore opale. Cavi regolabili in lunghezza. Emissione luce diretta.

LED Sorgente luminosa LED 3000 K, 30.000 h di durata.

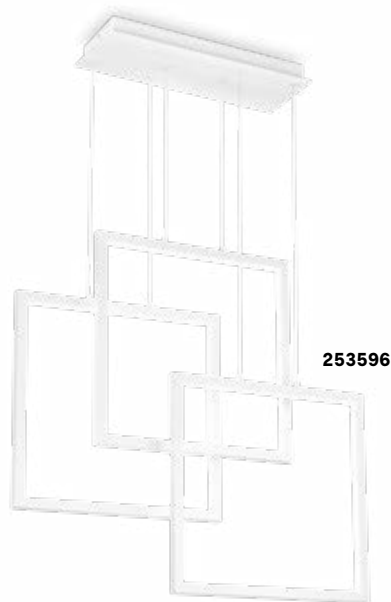
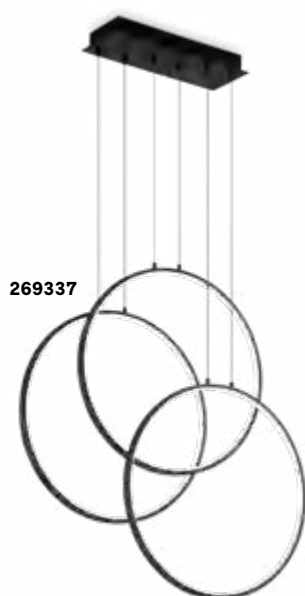

IP20	IP20	IP20
3,500 Kg / 0,1050 m³ LED 82W / 7300 lm	4,270 Kg / 0,0689 m³ LED 80W / 9100 lm	4,300 Kg / 0,2100 m³ LED 93W / 10700 lm
€ 355	€ 555	€ 550
269351 ■ Bianco 269337 ■ Nero	253596 ■ Bianco 269375 ■ Nero	253589 ■ Bianco 269382 ■ Nero

Fly new

Lampada a sospensione con base circolare e corpo luce in alluminio verniciato a polveri. Diffusore in PMMA microprismatizzato con controllo dell'abbagliamento (UGR < 19). Sorgente luminosa a LED integrati; CRI ≥ 80; protezione IP40, classe isolamento I.

Sorgente	LED SMD	UGR	<19
Potenza	18W / 65W	Durata LED	50.000 h
Driver incluso	On/Off	Classe isolamento	I
Driver disponibili	1-10V / DALI / Push	IP	40
MacAdam	SDCM 3	Materiale	Alluminio
CCT	3000 K / 4000 K	Garanzia	5 anni
CRI	≥80		

PRO

Prodotto ad alto contenuto tecnologico, elevata qualità dei materiali, destinato ad uso professionale.

IP40

Grado di protezione IP40.

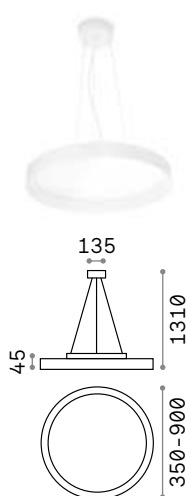

LED SMD SAMSUNG Driver TRIDONIC ON/OFF incluso

Dimensioni	Peso	Volume	Potenza	Lumen	CCT	Finitura	Color	Codice	€				
ø 350	4,500 Kg	0,0176 m³	18 W	2650 lm	3000 K	Bianco	■	276564	355				
						Nero	■	306704	355 <small>new</small>				
				2800 lm	4000 K	Bianco	■	276571	355				
						Nero	■	306711	355 <small>new</small>				
ø 450	5,200 Kg	0,0266 m³	26 W	3700 lm	3000 K	Bianco	■	276588	470				
						Nero	■	306728	470 <small>new</small>				
				3900 lm	4000 K	Bianco	■	276595	470				
						Nero	■	306735	470 <small>new</small>				
ø 600	6,000 Kg	0,0439 m³	53 W	7500 lm	3000 K	Bianco	■	276601	660				
						Nero	■	306742	660 <small>new</small>				
				8000 lm	4000 K	Bianco	■	276618	660				
						Nero	■	306759	660 <small>new</small>				
				ø 900	8,400 Kg	0,0919 m³	65 W	9400 lm	3000 K	Bianco	■	276625	1210
										Nero	■	306766	1210 <small>new</small>
ø 900	8,400 Kg	0,0919 m³	65 W	9900 lm	4000 K	Bianco	■	276632	1210				
						Nero	■	306773	1210 <small>new</small>				

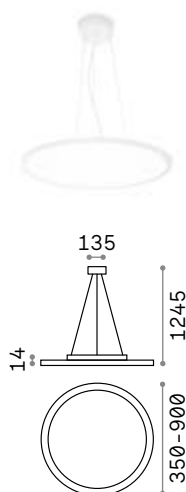

Dimensioni	Peso	Volume	Potenza	Lumen	CCT	Finitura	Color	Codice	€
ø 350	4,200 Kg	0,0167 m³	18 W	2650 lm	3000 K	Bianco	■	307961	320 <small>new</small>
				2800 lm	4000 K	Bianco	■	307978	320 <small>new</small>
ø 450	5,250 Kg	0,0337 m³	26 W	3700 lm	3000 K	Bianco	■	307985	405 <small>new</small>
				3900 lm	4000 K	Bianco	■	307992	405 <small>new</small>
ø 600	7,300 Kg	0,0715 m³	53 W	7500 lm	3000 K	Bianco	■	308005	570 <small>new</small>
				8000 lm	4000 K	Bianco	■	308012	570 <small>new</small>
ø 900	14,500 Kg	0,1464 m³	65 W	9400 lm	3000 K	Bianco	■	308029	1070 <small>new</small>
				9900 lm	4000 K	Bianco	■	308036	1070 <small>new</small>

Lunghezza cavo 1233 mm



P. 260





Halo





Lampada a sospensione con base circolare e corpo luce in alluminio verniciato a polveri. Diffusore opale in policarbonato. Sorgente luminosa a LED integrati con binning iniziale \leq 2-Step MacAdam; CRI \geq 80.

LED Sorgente luminosa LED 3000/4000 K, 35.000 h di durata.

 Luce indiretta inclusa.

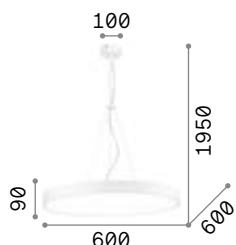
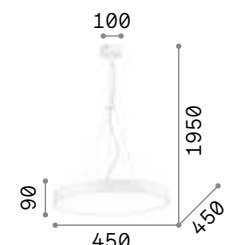
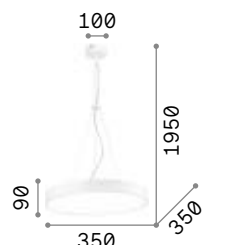

P. 270





		
 IP20	 IP20	 IP20
7,100 Kg / 0,0583 m³	4,930 Kg / 0,0329 m³	3,250 Kg / 0,0194 m³
LED 46W / 5950/6250 Lm	LED 32W / 4050/4200 Lm	LED 26W / 3150/3450 Lm
€ 610	€ 450	€ 350
226743 Bianco 3000K 226750 Bianco 4000K	226729 Bianco 3000K 226736 Bianco 4000K	226712 Bianco 3000K 223254 Bianco 4000K

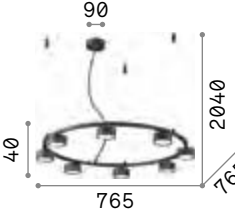
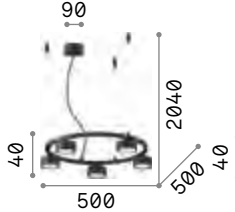
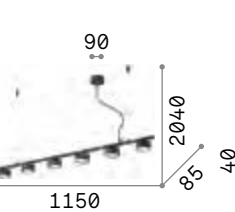
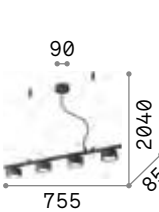

Minor

Montatura in metallo verniciato a polveri. Cavo elettrico in pvc. Sorgenti luminose a LED sostituibili.

LED Lampadine LED GX53 9W 3000 K incluse. Cod. **123936**

			
3,440 Kg / 0,1200 m ³ GX53 max 8 x 15W	2,250 Kg / 0,0564 m ³ GX53 max 5 x 15W	2,210 Kg / 0,0203 m ³ GX53 max 6 x 15W	1,650 Kg / 0,0135 m ³ GX53 max 4 x 15W
€ 480	€ 325	€ 325	€ 247
235547 ■ Nero	235516 ■ Nero	235486 ■ Nero	235455 ■ Nero
 3000 K 910 lm	 3000 K 910 lm	 3000 K 910 lm	 3000 K 910 lm
123936 € 6,00	123936 € 6,00	123936 € 6,00	123936 € 6,00



074

Look

Rosone e diffusore in metallo con varie finiture. Cavo in tessuto regolabile in lunghezza. Monta lampadine sostituibili. Modello con finitura cromo sfumato con diffusore in vetro.

LED Lampadine LED GU10 7W e GU10 10W 3000 K incluse.



104935 104942 141800 104928 141817 259239 141794 141855 170589

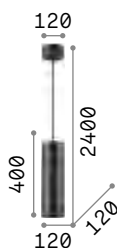

2,950 Kg / 0,0092 m³
GU10 max 1x50W

€ 132

158723 ■ Nero

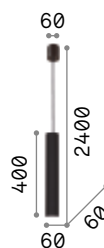

0,990 Kg / 0,0029 m³
GU10 max 1x28W

€ 72

104935 ■ Bianco
104942 ■ Cromo
104928 ■ Nero

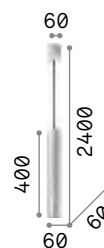

0,990 Kg / 0,0029 m³
GU10 max 1x28W

€ 95

194806 ■ Trasparen.
141800 ■ Argento
141817 ■ Oro
259239 ■ Ottone
141794 ■ Brunito
141855 ■ Rame
170589 ■ Corten

3000 K
800 lm

189031 € 15,00

3000 K
610 lm

123943 € 4,50

3000 K
610 lm

123943 € 4,50

Tube

Rosone e corpo luce in alluminio verniciato a polveri di colore bianco o nero. Cavo in tessuto. Sorgente luminosa a led integrati.

LED Sorgente luminosa LED 3000 K, 35.000 h di durata.

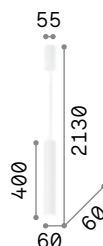

IP20

0,960 Kg / 0,0073 m³
LED 9W / 1200 lm

€ 210

211701 Bianco
211718 Nero

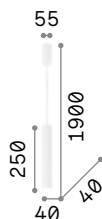

IP20

0,680 Kg / 0,0048 m³
LED 9W / 1200 lm

€ 150

211459 Bianco
211466 Nero

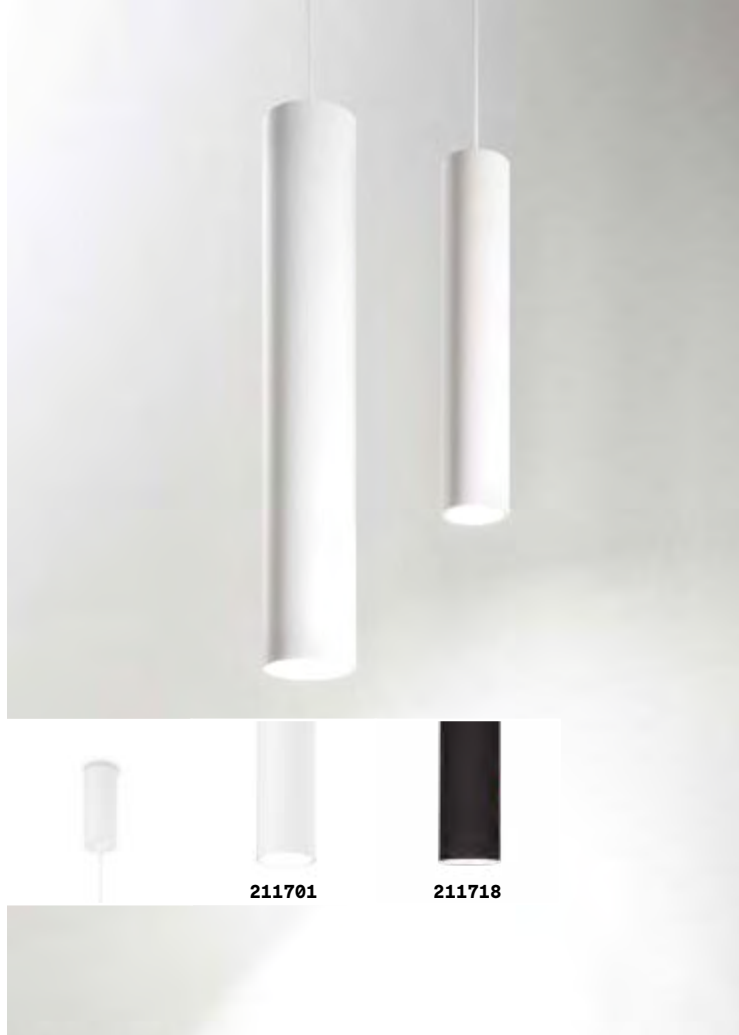

Oak

Rosone in metallo rifinito con vernice opaca. Diffusore in cemento. Cavo in tessuto nero.

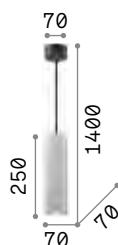

IP20

1,220 Kg / 0,0055 m³
GU10 max 1x 35W

€ 85

150635 Cemento

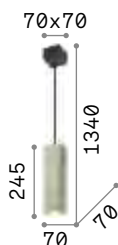

IP20

1,720 Kg / 0,0055 m³
GU10 max 1x 35W

€ 85

150673 Cemento

3000 K
440 lm
108292 € 4,50

3000 K
440 lm
108292 € 4,50



P. 304





Sky

Rosone e diffusore in metallo placcato o rifinito con vernice opaca bianco o nero.



Lampadine LED GU10 7W 3000 K incluse. Cod. **123943**



126906

126913

259017

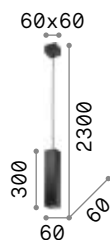

0,950 Kg / 0,0043 m³
GU10 max 1x28W

€ 96

126906 ■ Bianco
126913 ■ Nero
259017 ■ Ottone

3000 K
610 lm

123943 € 4,50



P. 299 P. 370



Filo

Base e corpi luci in metallo verniciato a polveri o placcato. Cavi elettrici in pvc nero. Colori: bianco, nero oppure ottone satinato.

LED Sorgente luminosa LED 3000 K, 30.000 h di durata.

263687

263670

263700

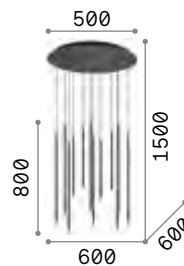

IP20

8,600 Kg / 0,1232 m³
LED 25W / 3150 lm

€ 690

263441 ■ Bianco
263434 ■ Nero
263663 ■ Ottone

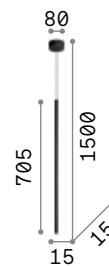

IP20

0,530 Kg / 0,0142 m³
LED 3,5W / 230 lm

€ 125

263687 ■ Bianco
263670 ■ Nero
263700 ■ Ottone



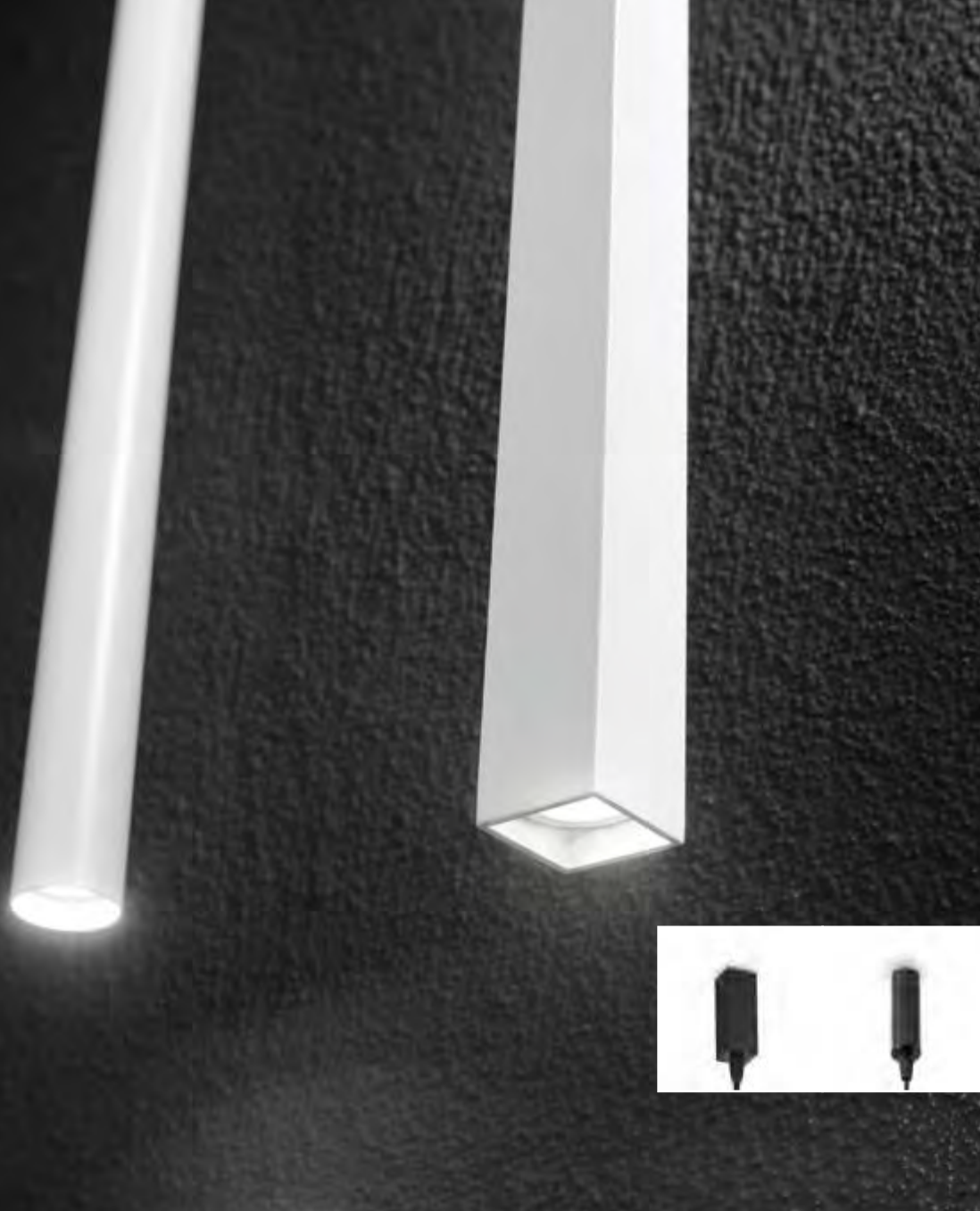

Ultrathin

Rosone e diffusore in metallo placcato cromo o rifinito con vernice opaca bianco o nero. Cavo elettrico in tessuto.

LED Sorgente luminosa LED 3000 K, 30.000 h di durata.

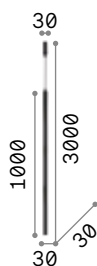

0,670 Kg / 0,0036 m³
LED 11,5W / 1250 lm / 51°

€ 125

142906 ■ Bianco
164878 ■ Cromo
142913 ■ Nero

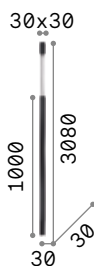

0,860 Kg / 0,0036 m³
LED 11,5W / 1250 lm / 51°

€ 180

194172 ■ Bianco
194196 ■ Nero

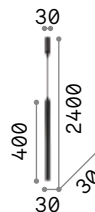

0,460 Kg / 0,0036 m³
LED 11,5W / 1250 lm / 51°

€ 95

156682 ■ Bianco
187662 ■ Cromo
156699 ■ Nero



0,450 Kg / 0,0019 m³
LED 11,5W / 1250 lm / 51°

€ 150

194189 ■ Bianco
194202 ■ Nero



142913, 156699 194196, 194202



Essence

Rosone e corpo luce in alluminio verniciato a polveri. Diffusore in materiale acrilico opale. Cavi in pvc. Colori: bianco o nero.

LED Sorgente luminosa LED 3000 K, 30.000 h di durata.

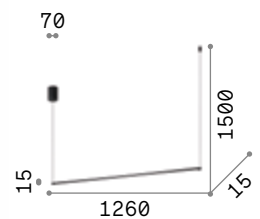
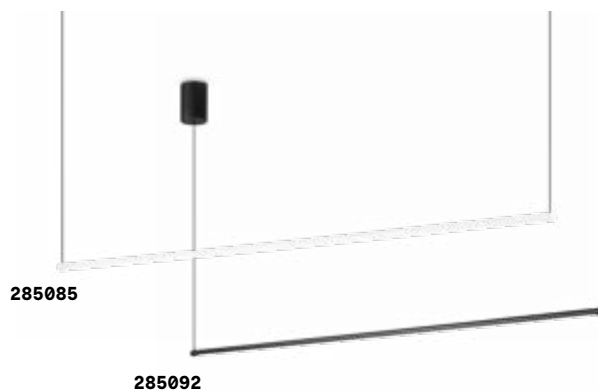

IP20

0,880 Kg / 0,0414 m³
LED 20W / 2650 lm

€ 275

285085 ■ Bianco
285092 ■ Nero



Yoko

Rosone, montatura e supporto per il cavo in metallo verniciato opaco. Diffusore in policarbonato opale. Cavo in pvc trasparente. Colori: bianco o nero.

LED Sorgente luminosa LED 3000 K, 30.000 h di durata.

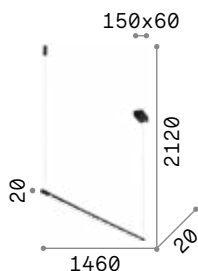

IP20

0,700 Kg / 0,0383 m³
LED 16W / 1450 lm

€ 155

258898 ■ Bianco
258928 ■ Nero



P. 452 P. 498



V-Line

Corpo luce in alluminio verniciato a polveri o placcato. Diffusore in silicone opale. Cavi d'acciaio con supporti cromati. Cavo elettrico in pvc. Colori: bianco, nero oppure ottone spazzolato.

LED Sorgente luminosa LED 3000 K, 20.000 h di durata.

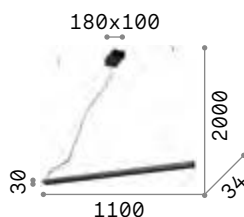

IP20

1,050 Kg / 0,0058 m³
LED 20W / 1800 lm

€ 215

275369 ■ Bianco
275376 ■ Nero
275383 ■ Ottone





Desk

Corpo luce e rosone in alluminio rifinito con vernice a polveri color bianco o nero opaco. Sospensione con cavi elettrici regolabili in lunghezza.

LED Sorgente luminosa LED 3000 K, 30.000 h di durata.



138237



173245

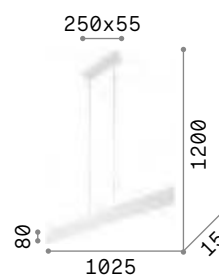

 IP20

1,890 Kg / 0,0196 m³
LED 32W / 2100 lm

€ 340

138237 ■ Bianco
173245 ■ Nero



P. 364



Craft **new**

Rosone in metallo verniciato nero opaco. Corpo luce in legno naturale. Diffusore in policarbonato opale satinato. Cavo in PVC trasparente.

LED Sorgente luminosa LED 3000 K, 20.000 h di durata.

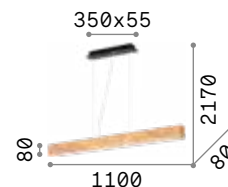
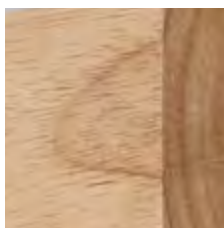

IP20

3,400 Kg / 0,0249 m³
LED 36W / 3500 lm

€ 360

284460 **Legno** **new**



P. 364



P. 502



Karousel

Montatura in metallo rifinito in ottone satinato. Diffusori in vetro incamiciato bianco, soffiato e acidato.

LED Lampadine LED G9 3W 3000 K incluse.
Cod. **209043**

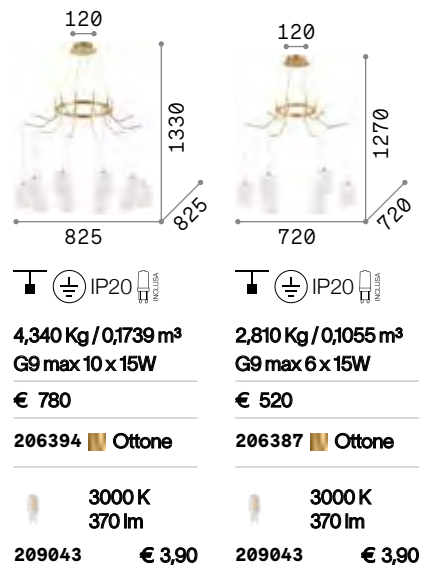



Rhapsody

Montatura in metallo con rosone rifinito ottone satinato e bracci nero opaco. Cavi in pvc. Diffusori in vetro soffiato bianco acidato.



Lampadine LED G9 3W 3000 K incluse.
Cod. 209043

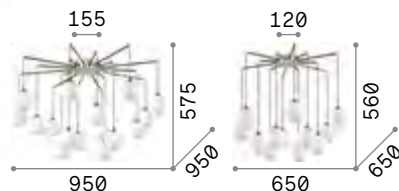

5,020 Kg / 0,2040 m³
G9 max 16 x 15W

€ 750

236964 ■ Nero

3000 K
370 lm

209043 € 3,90



3,510 Kg / 0,1400 m³
G9 max 12 x 15W

€ 550

236957 ■ Nero

3000 K
370 lm

209043 € 3,90



Lucciola new

Rosone e corpo luce sospeso in metallo verniciato a polveri o placcato. Diffusore sferico in acrilico satinato. Cavi in pvc con supporti a soffitto in alluminio. Colore: ottone o nero.

LED Sorgente luminosa LED 3000 K, 20.000 h di durata.



283982 283999

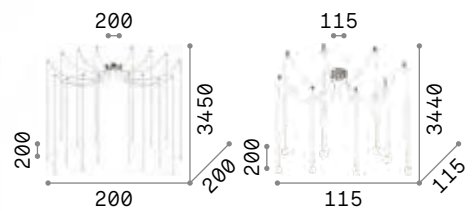

IP20

2,500 Kg / 0,0165 m³
LED 16W / 1150 lm

€ 750

284002 ■ Nero
284019 ■ Ottone

IP20

1,300 Kg / 0,0084 m³
LED 8W / 600 lm

€ 400

new 283982 ■ Nero new
new 283999 ■ Ottone new

Fish

Rosone, asta e diffusore in metallo verniciato nero opaco. Cavo in acciaio con supporto in metallo cromato. Led integrato con schermo opale.

LED Sorgente luminosa LED 3000 K, 20.000 h di durata.

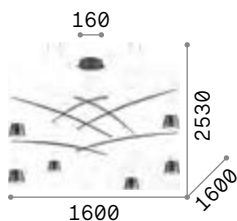

IP20

6,790 Kg / 0,0377 m³
LED 37W / 2800 lm

€ 670

196992 ■ Nero



Pop

Rosone, montatura e copri portalampade in metallo rifinito con vernice opaca nera. Cavi regolabili in lunghezza.

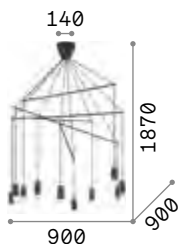

IP20

2,920 Kg / 0,0147 m³
E27 max 10 x 60W

€ 300

158860 ■ Nero

3000 K
900 lm

123899 € 7,00

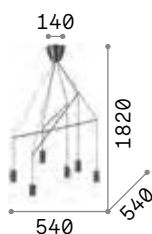

IP20

1,670 Kg / 0,0096 m³
E27 max 6 x 60W

€ 200

158815 ■ Nero

3000 K
900 lm

123899 € 7,00





Dynamite

Montatura in metallo rifinito con vernice a polveri o placcato e spazzolato. Diffusori orientabili. Cavo elettrico in tessuto. Sospensioni con incluso kit per installazione anche a plafone.

LED Lampadine LED GU10 7W 3000 K incluse. Cod. **123943**



231433

231396

244648



P. 306

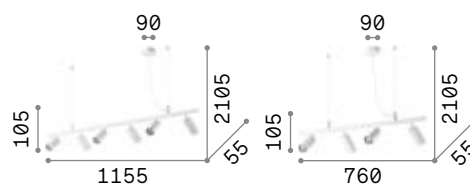

2,700 Kg / 0,0360 m³
GU10 max 6 x 28W

€ 425

231433 Bianco
231396 Nero
244648 Ottone

3000 K
610 lm

123943 € 4,50



2,310 Kg / 0,0243 m³
GU10 max 4 x 28W

€ 318

231372 Bianco
231341 Nero
244624 Ottone

3000 K
610 lm

123943 € 4,50



Pan

Montatura in metallo. Diffusori con elementi decorativi a tubi metallici di diverse misure. Cavi d'acciaio regolabili.

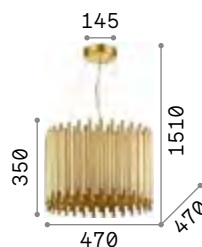

IP20

13,920 Kg / 0,1355 m³
E27 max 5 x 60W

€ 830

208817 Oro



3000 K
910 lm

119571

€ 7,00



P. 420



Triumph

Base, bracci e copri porta lampade in metallo con finitura nero opaco o ottone invecchiato.



242347



160269

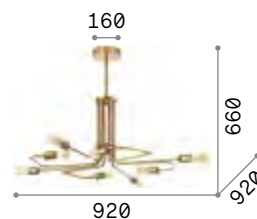

IP20

3,640 Kg / 0,0470 m³
E27 max 8 x 60W

€ 550

242347 ■ Nero
160269 ■ Ottone

2200 K
370 lm

151687 € 5,50



P. 318



P. 416



Abc

Rosone, copri portalamapade e struttura decorativa interamente in metallo rifinito ottone satinato. Cavo in tessuto nero.

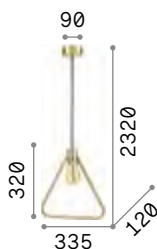

IP20

0,590 Kg / 0,0117 m³
E27 max 1x70W

€ 120

207834 ■ Ottone

2200 K
440 lm
151694 € 7,00

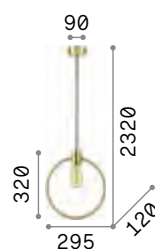

IP20

0,570 Kg / 0,0100 m³
E27 max 1x70W

€ 120

207841 ■ Ottone

2200 K
330 lm
151700 € 5,50

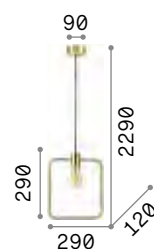

IP20

0,610 Kg / 0,0100 m³
E27 max 1x70W

€ 120

207858 ■ Ottone

2200 K
500 lm
151717 € 8,90



Lingotto

Montatura in metallo verniciato: base nera opaca e telaio ottone opaco. Diffusori in vetro incamiciato bianco, soffiato e acidato.

LED

Lampadine LED G9 3W 3000 K incluse nei modelli: **251110** e **251103**.
Cod. **209043**



IP20	IP20	IP20
4,530 Kg / 0,0564 m ³ E14 max 3 x 40W	2,260 Kg / 0,0442 m ³ G9 max 3 x 28W	0,660 Kg / 0,0105 m ³ G9 max 1 x 28W
€ 290	€ 240	€ 90
198125 ■ Ottone	251110 ■ Ottone	251103 ■ Ottone
3000 K 420 lm	3000 K 370 lm	3000 K 370 lm
101217 € 3,00	209043 € 3,90	209043 € 3,90



P. 327



P. 469



Igor

Montatura in metallo rifinito con vernice opaca nera. Diffusore con lastre di vetro trasparente.

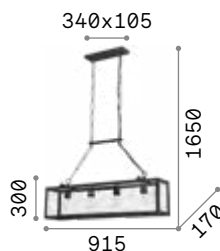

IP20

8,810 Kg / 0,0941m³
E27 max 4 x 60W

€ 390

092942 ■ Nero

2200 K
440 lm
151694 € 7,00

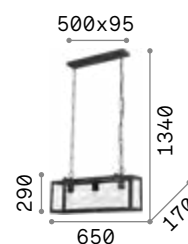

IP20

7,100 Kg / 0,0682m³
E27 max 3 x 60W

€ 300

092881 ■ Nero

2200 K
440 lm
151694 € 7,00

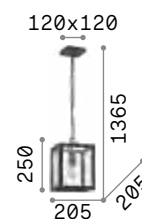

IP20

2,600 Kg / 0,0281m³
E27 max 1 x 60W

€ 150

092850 ■ Nero

2200 K
440 lm
151694 € 7,00





Birds

Montatura in metallo verniciato con disco decorativo in ottone satinato. Diffusori in vetro soffiato bianco acidato. Cavo in pvc con interruttore e spina. Colore: nero opaco con dettaglio ottone satinato.

LED Lampadine LED G9 3W 3000 K incluse.
Cod. 209043

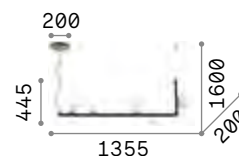

IP20

2,750 Kg / 0,1353 m³
G9 max 5 x 15W

€ 283

273648 ■ Nero

3000 K
370 lm

209043 € 3,90



P. 319 P. 413 P. 466 P. 492



Perline new

Rosone e montatura in metallo.
Diffusori in vetro incamiciato
bianco, soffiato e acidato. Cavo
elettrico in teflon trasparente.
Finiture: nero opaco oppure ottone
satinato.

LED Lampadine LED G9 3W 3000 K incluse.
Cod. **209043**



306995

282107

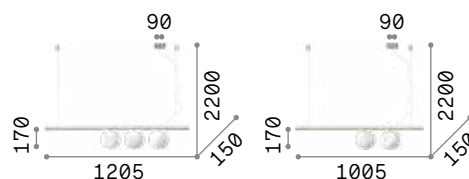

1,600 Kg / 0,0584 m³
G9 max 3 x 40W

€ 215

307008 ■ Nero new
282114 ■ Ottone new

3000 K
370 lm

209043 € 3,90



1,200 Kg / 0,0546 m³
G9 max 2 x 40W

€ 155

306995 ■ Nero new
282107 ■ Ottone new

3000 K
370 lm

209043 € 3,90



Perlage new

Montatura in metallo con struttura lineare a sezione tonda o circolare a sezione quadrata. Diffusori in vetro soffiato. Cavi in acciaio gommati. Cavo elettrico in pvc. Finiture: nero opaco con vetri pirex fumé o ottone satinato con vetri bianchi acidati.

LED Lampadine LED G9 3W 3000 K incluse.
Cod. **209043**



271422



283821

IP20 <small>INCLUSA</small>	IP20 <small>INCLUSA</small>	IP20 <small>INCLUSA</small>	IP20 <small>INCLUSA</small>	IP20 <small>INCLUSA</small>
8,920 Kg / 0,2722 m ³ G9 max 30 x 15W	3,400 Kg / 0,1140 m ³ G9 max 14 x 15W	2,800 Kg / 0,0887 m ³ G9 max 11 x 15W	2,200 Kg / 0,0777 m ³ G9 max 10 x 15W	1,400 Kg / 0,0393 m ³ G9 max 6 x 15W
€ 1400	€ 620	€ 530	€ 390	€ 260
296753 ■ Nero <small>new</small> 296746 ■ Ottone <small>new</small>	271385 ■ Nero <small>new</small> 283814 ■ Ottone <small>new</small>	271392 ■ Nero 283807 ■ Ottone	271408 ■ Nero 283791 ■ Ottone	271422 ■ Nero 283821 ■ Ottone



P. 415



P. 466



P. 494



3000 K
370 lm

209043

€ 3,90



3000 K
370 lm

209043

€ 3,90



3000 K
370 lm

209043

€ 3,90



3000 K
370 lm

209043

€ 3,90



3000 K
370 lm

209043

€ 3,90



Equinoxe new

Montatura a bracci in metallo con finitura cromo o ottone antico. Diffusori in vetro soffiato trasparente.

LED Lampadine LED G4 2W 3000 K incluse.
Cod. **222257**



200118



200125

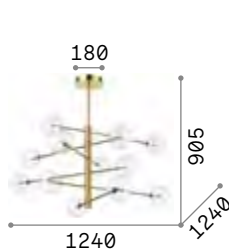

5,540 Kg / 0,1304 m³
G4 max 12 x 2W

€ 950

200118 Cromo
200125 Ottone

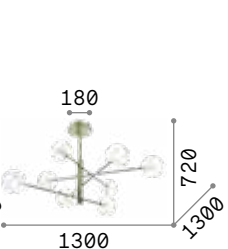

4,460 Kg / 0,1427 m³
G4 max 8 x 2W

€ 750

275178 Cromo
275215 Ottone

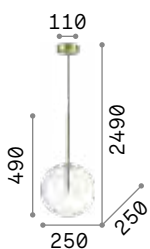

0,850 Kg / 0,0326 m³
G4 max 1 x 2W

€ 180

306551 Cromo
277394 Ottone

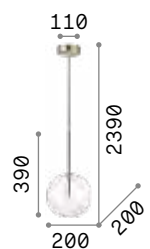

0,700 Kg / 0,0211 m³
G4 max 1 x 2W

€ 140

306544 Cromo
277387 Ottone

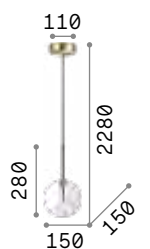

0,640 Kg / 0,0170 m³
G4 max 1 x 2W

€ 120

306537 Cromo
277370 Ottone

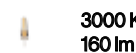

222257

3000 K
160 lm

€ 4,50



222257

3000 K
160 lm

€ 4,50

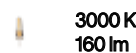

222257

3000 K
160 lm

€ 4,50

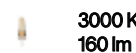

222257

3000 K
160 lm

€ 4,50

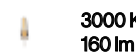

222257

3000 K
160 lm

€ 4,50



P. 417



P. 495



Copernico

Montatura in metallo verniciato bianco o nero opaco con dettagli in ottone. Diffusori in vetro incamiciato bianco soffiato e acidato.

LED

Lampadine LED G9 3W 3000 K incluse.
Cod. 209043



197302



197319

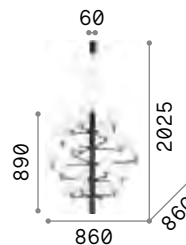

IP20

10,270 Kg / 0,1340 m³
G9 max 20 x 40W

€ 1050

197326 ■ Bianco
197333 ■ Nero

3000 K
370 lm

209043 € 3,90

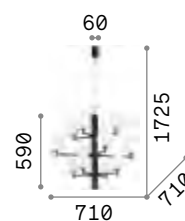

IP20

6,870 Kg / 0,0970 m³
G9 max 12 x 40W

€ 650

197302 ■ Bianco
197319 ■ Nero

3000 K
370 lm

209043 € 3,90

Kepler

Catena e montatura in metallo verniciato nero opaco. Diffusori in vetro soffiato trasparente ambrato.

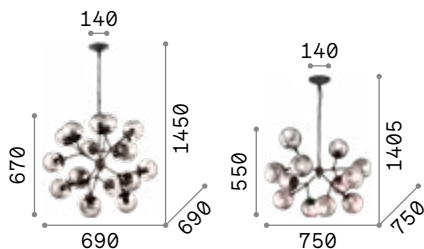

IP20

5,300 Kg / 0,1296 m³
E27 max 18 x 40W

€ 600

162478 ■ Nero

3000 K
430 lm
101279 € 3,00

IP20

3,630 Kg / 0,0990 m³
E27 max 12 x 40W

€ 400

162201 ■ Nero

3000 K
430 lm
101279 € 3,00



P. 414



Spark

Rosone e montatura in metallo verniciato nero opaco con portalampade placcati. Cavo elettrico rivestito in tessuto.

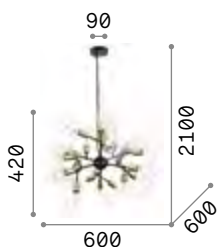

IP20

3,000 Kg / 0,0885 m³
E27 max 24 x 25W

€ 500

238241 ■ Nero

3000 K
1120 lm
101323 € 7,50



P. 324



Leaves

Montatura in metallo bianco.
Elementi decorativi in vetro soffiato bianco e modellato a mano. Cavi d'acciaio regolabili in lunghezza.

LED Lampadine LED G9 3W 3000 K incluse.
Cod. **209043**

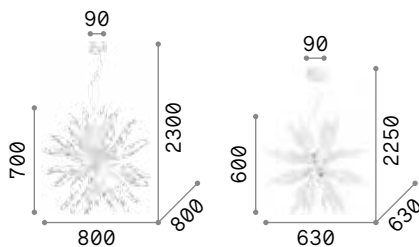

5,800 Kg / 0,1123 m³
G9 max 12 x 40W

€ 880

112268 Bianco

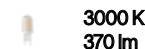

209043 € 3,90



3,700 Kg / 0,0702 m³
G9 max 8 x 40W

€ 580

111957 Bianco

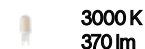

209043 € 3,90



Pauline

Montatura in metallo cromato.
Elementi decorativi in vetro soffiato e modellato a mano. Sospensioni con cavi d'acciaio regolabili in lunghezza.

LED Lampadine LED G9 3W 3000 K incluse.
Cod. **209043**

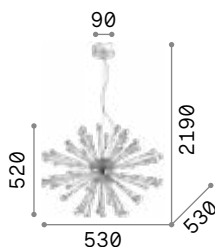

6,300 Kg / 0,0596 m³
G9 max 8 x 40W

€ 650

115801 Fumè

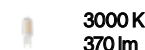

209043 € 3,90



P. 321



Vortex

Montatura in metallo verniciato bianco opaco. Elementi decorativi in metallo modellato artigianalmente e dipinti a mano con oro o argento.

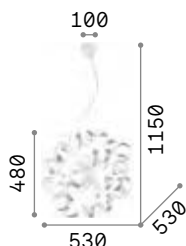

IP20

2,500 Kg / 0,2344 m³

E14 max 6x 40W

€ 250

101613 Argento

101606 Oro

3000 K
480 lm

101200 € 3,00



101613



101606



Dust

Montatura in tubolare di alluminio argentato lavorato e modellato artigianalmente. Cavo elettrico regolabile in lunghezza.

LED Lampadine LED G9 3W 3000 K incluse.
Cod. 209043

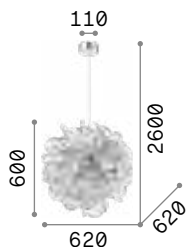

IP20

2,280 Kg / 0,2421 m³

G9 max 12x 40W

€ 735

114361 Argento

3000 K
370 lm

209043 € 3,90

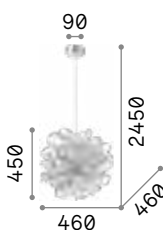

IP20

1,450 Kg / 0,1250 m³

G9 max 8x 40W

€ 445

114811 Argento

3000 K
370 lm

209043 € 3,90

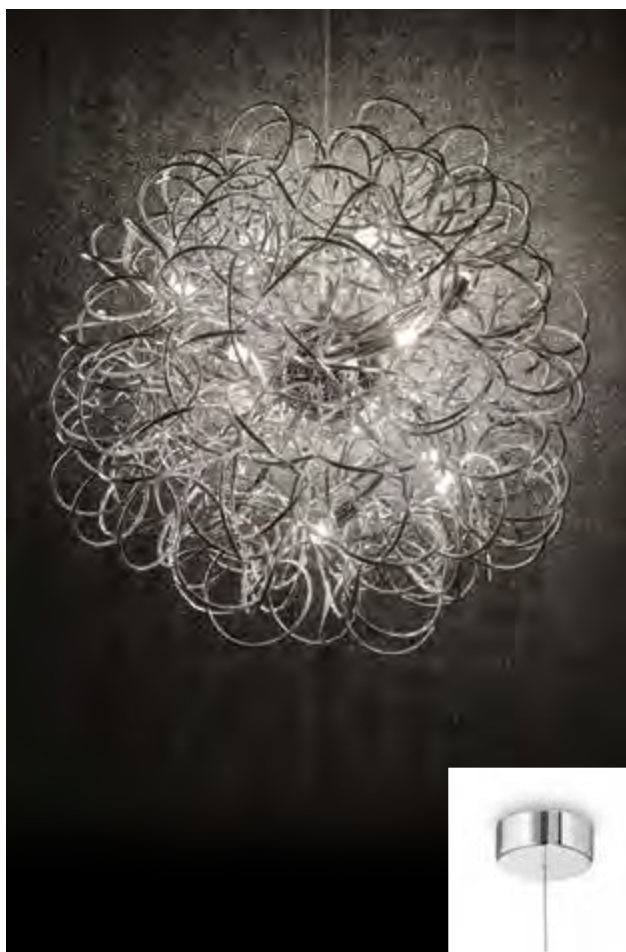



Disco

Montatura con elementi decorativi circolari rotanti e posizionabili a piacere. Disponibile in metallo verniciato in bianco o nero opaco oppure in legno naturale sagomato.



138275



103723



114262

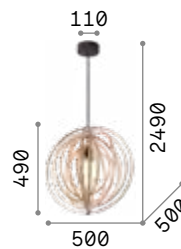

IP20

1,240 Kg / 0,0447 m³
E27 max 1x 60W

€ 220

138275 ■ Legno

3000 K
950 lm

101330 € 8,00

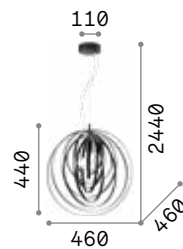

IP20

2,660 Kg / 0,0365 m³
E27 max 1x 60W

€ 260

103723 ■ Bianco
114262 ■ Nero

3000 K
950 lm

101330 € 8,00



Konse

Montatura ed elementi decorativi interamente in metallo. Finitura con vernice oro scuro satinato.

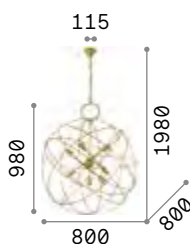

IP20

4,600 Kg / 0,7203 m³
E27 max 7 x 60W

€ 1000

156033 Oro

3000 K
910 lm
119571 € 7,00



IP20

3,510 Kg / 0,1201 m³
E27 max 6 x 60W

€ 650

156026 Oro

3000 K
910 lm
119571 € 7,00

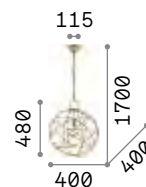

IP20

1,930 Kg / 0,1175 m³
E27 max 1 x 60W

€ 300

155968 Oro

3000 K
910 lm
119571 € 7,00



Ampolla

Rosone porta lampade e struttura decorativa in metallo con finitura bianco e nero. Cavo elettrico regolabile in lunghezza.

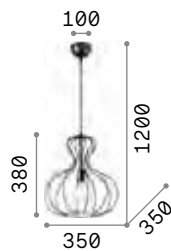

IP20

0,950 Kg / 0,0709 m³
E27 max 1x60W

€ 120

194295 Bianco
148502 Nero

2200 K
500 lm
151717 € 8,90

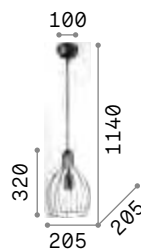

IP20

0,590 Kg / 0,0480 m³
E27 max 1x60W

€ 110

200880 Bianco
148151 Nero

2200 K
370 lm
151687 € 5,50

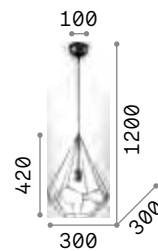

IP20

0,720 Kg / 0,0480 m³
E27 max 1x60W

€ 198

200897 Bianco
148175 Nero

2200 K
440 lm
151694 € 7,00

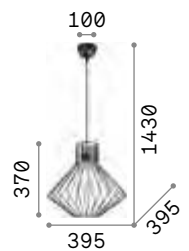

IP20

1,470 Kg / 0,0709 m³
E27 max 1x60W

€ 214

200903 Bianco
167497 Nero

2200 K
440 lm
151694 € 7,00



Onion

Struttura in metallo con finitura in vernice marrone ad effetto metallico. Cavo in tessuto.



IP20

5,050 Kg / 0,2383 m³
E27 max 1x60W

€ 400

205311 ■ Coffee

2200 K
480 lm

151724 € 8,50

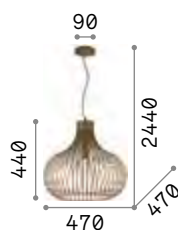

IP20

3,520 Kg / 0,1325 m³
E27 max 1x60W

€ 270

205304 ■ Coffee

2200 K
480 lm

151724 € 8,50

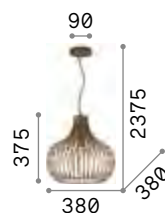

IP20

2,380 Kg / 0,0705 m³
E27 max 1x60W

€ 180

205298 ■ Coffee

2200 K
500 lm

151717 € 8,90

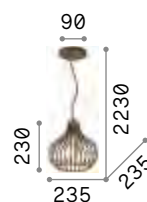

IP20

1,260 Kg / 0,0169 m³
E27 max 1x60W

€ 95

205281 ■ Coffee

2200 K
500 lm

151717 € 8,90



Ice

Rosone e montatura in metallo verniciato bianco o nero opaco. Copri porta lampade in metallo rifinito ottone satinato. Cavo elettrico in pvc.



237671



237664

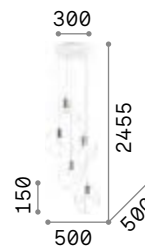

IP20

2,920 Kg / 0,0345 m³
E27 max 5 x 60W

€ 230

237671 ■ Bianco
237664 ■ Nero

3000 K
340 lm

101286 € 3,00

Citrus

Corpo luce con elementi multistrato di legno verniciato. Cavo in tessuto nero.

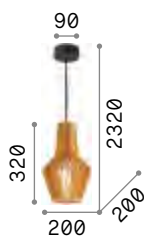

0,660 Kg / 0,0174 m³
E27 max 1x60W

€ 152

159843 Legno

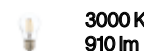

119571 € 7,00

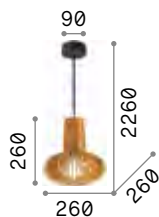

0,720 Kg / 0,0242 m³
E27 max 1x60W

€ 160

159850 Legno

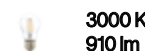

119571 € 7,00

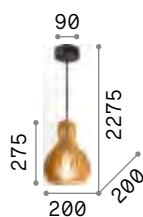

0,510 Kg / 0,0148 m³
E27 max 1x60W

€ 135

159867 Legno

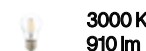

119571 € 7,00



Lugano

Rosone in metallo verniciato opaco. Cavo in tessuto con portalampane in metallo brunito. Diffusore in ceramica.

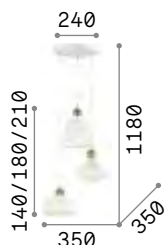

2,950 Kg / 0,0618 m³
E27 max 3x60W

€ 385

206875 Bianco

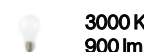

123899 € 7,00

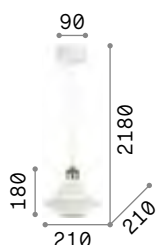

0,850 Kg / 0,0090 m³
E27 max 1x60W

€ 138

206806 Bianco

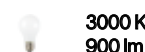

123899 € 7,00

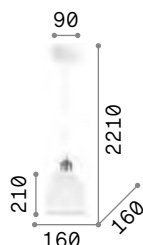

0,860 Kg / 0,0068 m³
E27 max 1x60W

€ 138

206820 Bianco

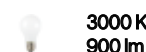

123899 € 7,00



Frida

Rosone e copriportalampada in metallo con finitura placcata o in vernice opaca. Cavo in tessuto nero.

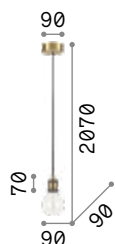

0,320 Kg / 0,0015 m³
E27 max 1x60W

€ 37

139432 Cromo
139425 Nero
122106 Rame
122083 Brunito

2200 K
500 lm



151717 € 8,90 P. 411



Doc

Rosone e copriportalampada in metallo con finiture varie. Cavo in tessuto nero. Interruttore incorporato al portalampada.



Lampada con interruttore integrato.

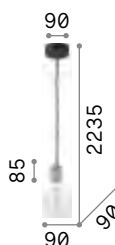

0,220 Kg / 0,0015 m³
E27 max 1x60W

€ 70

163123 Rame
163154 Ottone
163109 Brunito
163161 Piombo

2200 K
330 lm

223933 € 7,50



Edison

Rosone e copri porta lampada in metallo rifinito con vernice opaca bianca o nera. Cavo elettrico in tessuto.

LED

Lampadine LED E27 8W Globo D125 trasparente 3000 K incluse.
Cod. **101347**

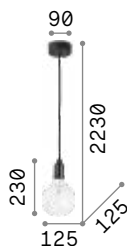

0,320 Kg / 0,0098 m³
E27 max 1x60W

€ 67

113302 Bianco
113319 Nero

3000 K
1020 lm

101347 € 8,50

P. 408



Hugo

Rosone e corpo luce in metallo con finitura in vernice opaca nera. Cavo elettrico in pvc.

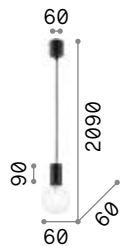

0,380 Kg / 0,0099 m³
E27 max 1x60W

€ 40

139685 Nero

3000 K
1020 lm

101347 € 8,50

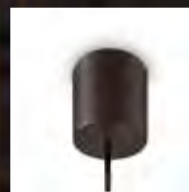
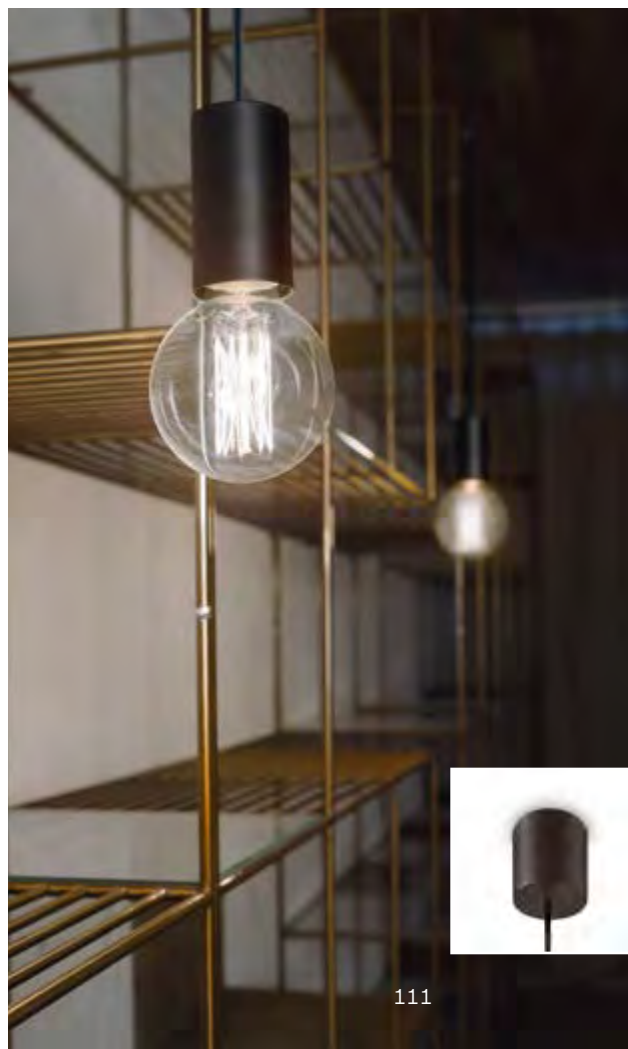



Minimal

Montatura in metallo rifinito in smalto colorato. Cavo elettrico con rivestimento in tessuto.
Sospensioni SPI fornite con due metri di cavo.

LED Lampadine LED E27 8W Globo D125 trasparente 3000 K incluse.
Cod. **101347**

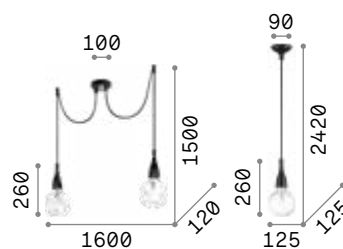

IP20

0,900 Kg / 0,0171 m³
E27 max 2 x 60W

€ 127

112718 ■ Bianco
112671 ■ Nero

3000 K
1020 lm

101347 € 8,50

IP20

0,470 Kg / 0,0099 m³
E27 max 1 x 70W

€ 66

009360 ■ Bianco
009407 ■ Nero
009391 ■ Oro

3000 K
1020 lm

101347 € 8,50



P. 410



P. 500



Mr Jack

Montatura e diffusore sferico in metallo rifinito in bianco, cromo o nero. Cavo elettrico rivestito in tessuto.

LED Lampadine LED GU10 7W 3000 K incluse. Cod. **123943**

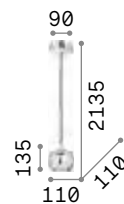
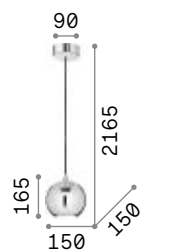

0,890 Kg / 0,0090 m³
GU10 max 1x28W

0,520 Kg / 0,0040 m³
GU10 max 1x28W

€ 94

€ 83

231273 Bianco
116464 Cromo
231297 Nero

231228 Bianco
116457 Cromo
231259 Nero

3000 K
610 lm
123943 € 4,50

3000 K
610 lm
123943 € 4,50



Oil

Montatura in metallo con finitura nero opaco. Diffusore in cemento. Per il modello 110462 12 metri di cavo rivestito in tessuto e fornito con sei ganci di fissaggio e spina italiana che può essere sostituita al rosone.

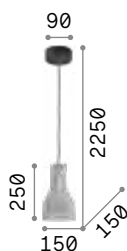

1,780 Kg / 0,0130 m³
E27 max 1x 15W

€ 116

110417 ■ Cemento

3000 K
430 lm

101279 € 3,00

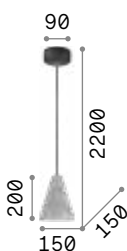

1,180 Kg / 0,0119 m³
E27 max 1x 15W

€ 116

110424 ■ Cemento

3000 K
430 lm

101279 € 3,00

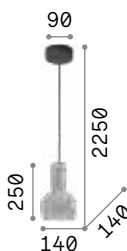

1,810 Kg / 0,0130 m³
E27 max 1x 15W

€ 116

110431 ■ Cemento

3000 K
430 lm

101279 € 3,00

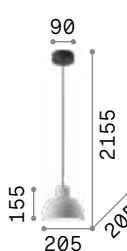

1,650 Kg / 0,0165 m³
E27 max 1x 15W

€ 116

129082 ■ Cemento

3000 K
430 lm

101279 € 3,00



1,760 Kg / 0,0236 m³
E27 max 1x 15W

€ 116

129099 ■ Cemento

3000 K
430 lm

101279 € 3,00

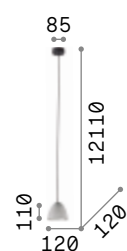

1,490 Kg / 0,0111 m³
GU10 max 1x 15W

€ 138

110462 ■ Cemento

3000 K
440 lm

108292 € 4,50

Tall

Diffusore e dettagli in metallo verniciato bianco o nero opaco. Modello 196794 e 196800 con led integrato e schermo opale. Modello 196770 e 196787 aperto e con lampadina sostituibile.

LED Sorgente luminosa LED 3000 K nel modello **196794** e **196800**, 20.000 h di durata.

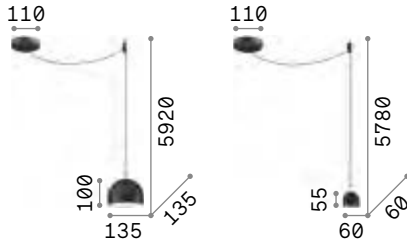

IP20

0,550 Kg / 0,0036 m³
E27 max 1x42W

€ 135

196770 Bianco
196787 Nero

IP20

0,500 Kg / 0,0024 m³
LED 4,5W / 510lm

€ 155

196794 Bianco
196800 Nero

3000 K
340 lm
101286 € 3,00

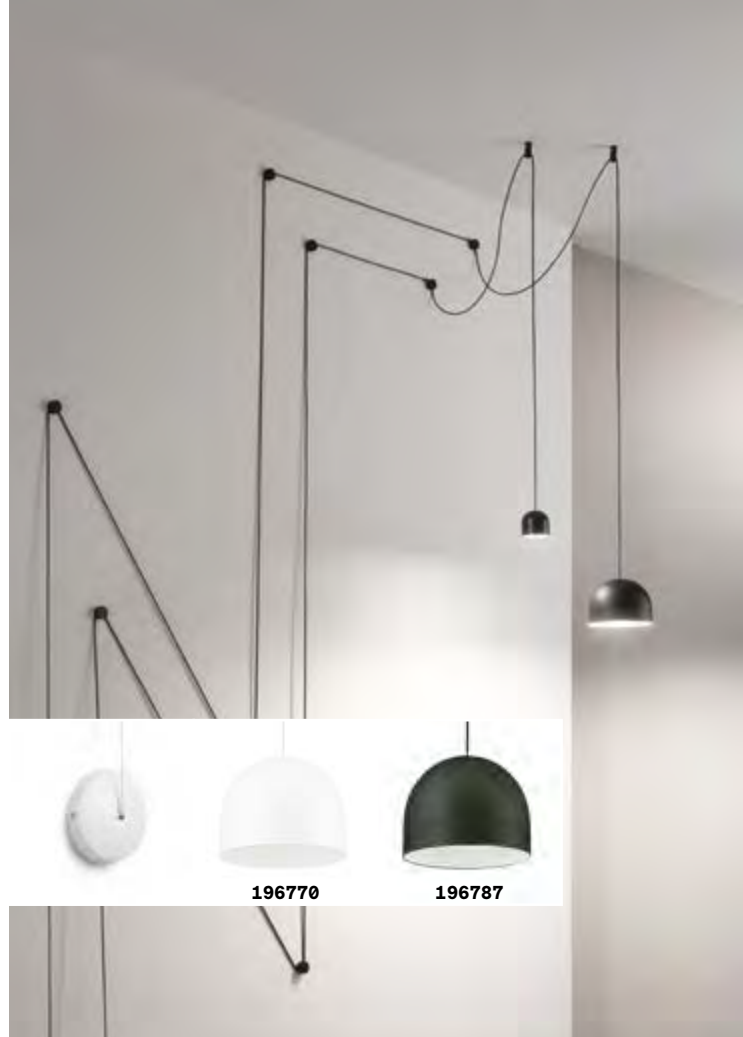

196770

196787

A-Line

Rosone in metallo verniciato a polveri. Diffusore in metallo verniciato bianco o nero opaco con interno bianco. Cavo rivestito in tessuto.

LED Lampadine LED GU10 7W 3000 K incluse nei modelli: **232690** e **232713**. Cod. **123943**

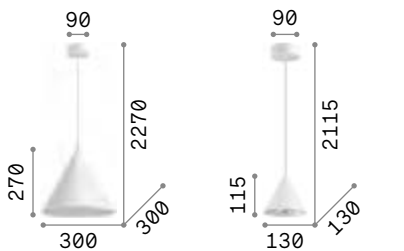

IP20

1,080 Kg / 0,0491 m³
E27 max 1x60W

€ 75

232720 Bianco
232744 Nero

IP20

0,330 Kg / 0,0114 m³
GU10 max 1x28W

€ 53

232690 Bianco
232713 Nero

3000 K
900 lm
123899 € 7,00

3000 K
610 lm
123943 € 4,50



232690

232713



Diesis

Rosone e diffusore in metallo verniciato a polveri o placcato. Cavo in pvc nero. Colori: nero, nichel satinato oppure ottone satinato.

LED Sorgente luminosa LED 3000 K, 20.000 h di durata.

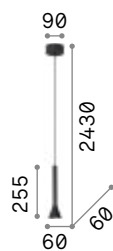

IP20

0,450 Kg / 0,0054 m³
LED 7W / 580 lm

€ 96

285122 ■ Nickel
279770 ■ Nero
279794 ■ Ottone



Holly

Rosone e diffusori in metallo con finitura ottone spazzolato o verniciato a polveri con finitura bianca o nera. Cavi rivestiti in tessuto.

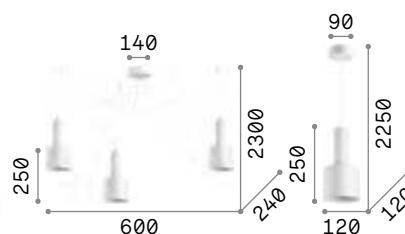

IP20

2,740 Kg / 0,0254 m³
E27 max 3 x 60W

€ 190

231587 ■ Bianco
231594 ■ Nero
231600 ■ Ottone

3000 K
900 lm

123899 € 7,00

IP20

0,780 Kg / 0,0064 m³
E27 max 1 x 60W

€ 75

231556 ■ Bianco
231563 ■ Nero
231570 ■ Ottone

3000 K
900 lm

123899 € 7,00



Triade

Rosone e diffusore in metallo verniciato a polveri con interno bianco. Elemento decorativo a sfera dorato.

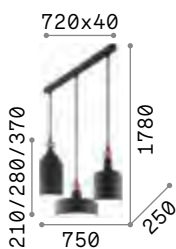

IP20

2,630 Kg / 0,0797 m³
E27 max 3 x 42W

€ 250

194677 ■ Grigio Scuro

3000 K
900 lm

123899 € 7,00

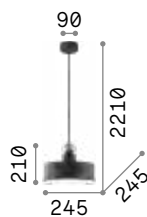

IP20

0,960 Kg / 0,0169 m³
E27 max 1 x 42W

€ 75

221489 ■ Grigio Scuro

3000 K
900 lm

123899 € 7,00

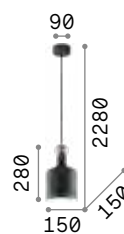

IP20

0,750 Kg / 0,0090 m³
E27 max 1 x 42W

€ 75

221496 ■ Grigio Scuro

3000 K
900 lm

123899 € 7,00

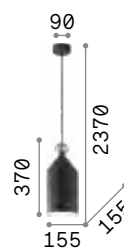

IP20

1,020 Kg / 0,0105 m³
E27 max 1 x 42W

€ 75

194684 ■ Grigio Scuro

3000 K
900 lm

123899 € 7,00



Mix Up new

Rosone e paralumi intercambiabili in metallo verniciato a polveri. Cavo in PVC. Interno bianco con finiture: bianco oppure nero.

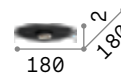
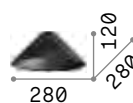
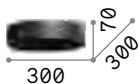
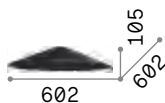
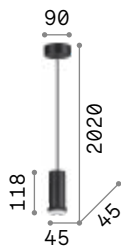

IP20

0,460 Kg / 0,0018 m³
E27 max 1x60W

€ 55

2,000 Kg / 0,0676 m³

€ 175

1,100 Kg / 0,0446 m³

€ 110

0,800 Kg / 0,0147 m³

€ 90

0,500 Kg / 0,0174 m³

€ 90

0,340 Kg / 0,0008 m³

€ 65

288406 ■ Bianco
288390 ■ Nero

new 288437 ■ Bianco
new 288420 ■ Nero

new 307404 ■ Bianco
new 288475 ■ Nero

new 307411 ■ Bianco
new 288444 ■ Nero

new 307428 ■ Bianco
new 288451 ■ Nero

new 307435 ■ Bianco
new 288482 ■ Nero new

3000 K
900 lm
123899 € 7,00



Yurta

Rosone e paralume in metallo verniciato a polveri. Cavi rivestiti in tessuto. Colori: tutto bianco o nero con interno bianco.



285146



281568



IP20

1,760 Kg / 0,0687 m³
E27 max 1x60W

€ 110

285160 ■ Bianco
281582 ■ Nero

3000 K
900 lm

123899 € 7,00

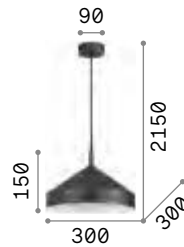

IP20

1,000 Kg / 0,0277 m³
E27 max 1x60W

€ 80

285153 ■ Bianco
285139 ■ Nero

3000 K
340 lm

101286 € 3,00

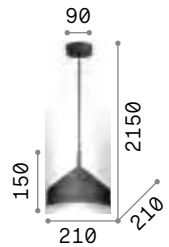

IP20

0,740 Kg / 0,0138 m³
E27 max 1x60W

€ 70

285146 ■ Bianco
281568 ■ Nero

3000 K
340 lm

101286 € 3,00

Metro

Montatura e diffusore in metallo.
Interno smaltato in bianco. Cavo
elettrico regolabile in lunghezza.

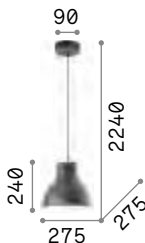

0,970 Kg / 0,0261 m³

E27 max 1x60W

€ 70

139098 ■ Grigio Scuro

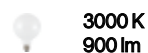

101354 € 8,50



Breeze

Montatura e diffusore in metallo.
Interno smaltato in bianco. Cavo
elettrico regolabile in lunghezza.

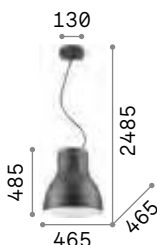

3,490 Kg / 0,0707 m³

E27 max 1x60W

€ 195

232041 ■ Grigio Scuro

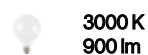

101354 € 8,50

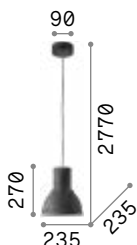

0,790 Kg / 0,0206 m³

E27 max 1x60W

€ 65

137681 ■ Grigio Scuro

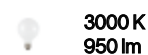

101330 € 8,00





Hangar

Montatura e diffusore in alluminio anodizzato. Interno smaltato bianco. Cavo elettrico regolabile in lunghezza.



100326



100333



IP20

1,800 Kg / 0,0442 m³
E27 max 1x60W

€ 200

100326 ■ Alluminio
100333 ■ Nero

3000 K
900 lm

101354 € 8,50



Fisherman

Corpo luce interamente in metallo con finitura in cromo, rame o in vernice nera opaca. Diffusore in lastra di vetro serigrafato bianco.

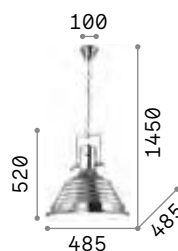

⚡ IP20

5,040 Kg / 0,0899 m³
E27 max 1x60W

€ 400

125824 ■ Cromo
125831 ■ Nero
134871 ■ Rame

💡 3000 K
1120 lm

101323 € 7,50



Eris

Montatura in metallo con rosone e diffusore verniciati bianco o nero opaco, dettagli in finitura oro satinato. Cavo elettrico intrecciato con rivestimento in tessuto.



238104



249056

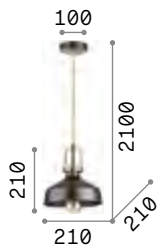

IP20

0,630 Kg / 0,0102 m³
E27 max 1x60W

€ 75

238104 ■ Bianco
249056 ■ Nero

3000 K
340 lm

101286 € 3,00

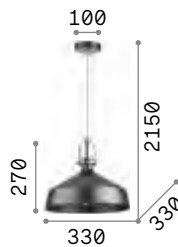

IP20

1,080 Kg / 0,0257 m³
E27 max 1x60W

€ 86

238135 ■ Bianco
249063 ■ Nero

3000 K
950 lm

101330 € 8,00

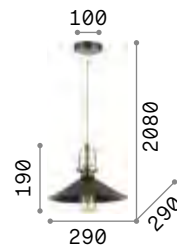

IP20

0,740 Kg / 0,0126 m³
E27 max 1x60W

€ 75

238173 ■ Bianco
249070 ■ Nero

3000 K
340 lm

101286 € 3,00

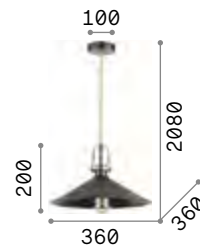

IP20

0,960 Kg / 0,0231 m³
E27 max 1x60W

€ 86

238210 ■ Bianco
249087 ■ Nero

3000 K
340 lm

101286 € 3,00



Moby

Montatura e diffusore in metallo con interno bianco. Disponibile nelle finiture alluminio, bianco, nero o rame.

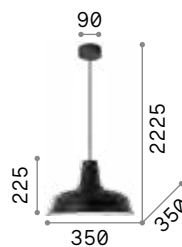

IP20

1,200 Kg / 0,0356 m³
E27 max 1x 42W

€ 127

102047 Bianco
102054 Alluminio
093659 Nero
093697 Rame



102047



102054



093659



093697

 3000 K
950 lm
101330 € 8,00



Sailor

Corpo luce a cupola in metallo con finitura brunito e rame e smaltato bianco all'interno. Diffusore in vetro soffiato con effetto rustico.



025278



025308

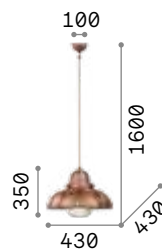

IP20

2,920 Kg / 0,1060 m³
E27 max 1x 60W

€ 200

025315 Rame
025285 Brunito

3000 K
910 lm
119571 € 7,00

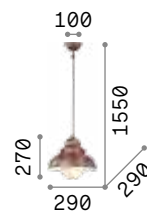

IP20

1,700 Kg / 0,0467 m³
E27 max 1x 60W

€ 150

025278 Rame
025308 Brunito

3000 K
910 lm
119571 € 7,00

Cantina

Montatura, diffusore e copriportalampada in metallo disponibile con finitura brunito o rame. Cavo elettrico rivestito in tessuto e intrecciato.

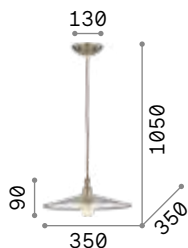

IP20

0,810 Kg / 0,0189 m³
E27 max 1x60W

€ 95

112732 ■ Rame
112701 ■ Brunito

3000 K
910 lm

119571 € 7,00



P. 418



Up and Down

Montatura in metallo rifinito con vernice nera opaca. Copriportalampade e viti in metallo brunito. Diffusori regolabili in altezza individualmente con sistema a contrappeso.

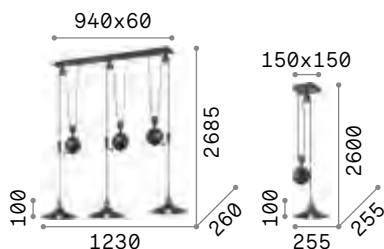

IP20

6,760 Kg / 0,0582 m³
E27 max 3x60W

€ 450

136349 ■ Nero

2200 K
370 lm

151687 € 5,50

IP20

1,940 Kg / 0,0151 m³
E27 max 1x60W

€ 150

136332 ■ Nero

2200 K
370 lm

151687 € 5,50





Flam

Montatura in metallo cromato.
 Diffusore in vetro pirex
 trasparente, smerigliato nella zona
 centrale.

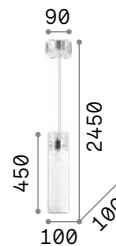

IP20

1,330 Kg / 0,0164 m³
 E27 max 1x 60W

€ 68

027364 Bianco

3000 K
 910 lm
 119571 € 7,00

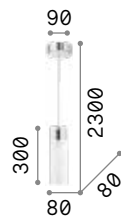

IP20

0,810 Kg / 0,0115 m³
 E27 max 1x 60W

€ 62

027357 Bianco

3000 K
 910 lm
 119571 € 7,00

Iguazù

Montatura in metallo cromato.
Diffusore in vetro pirex e
pendenti con ottagoni di cristallo.
Sospensioni con cavi a lunghezza
regolabile da dispositivi ferma cavo
automatici.

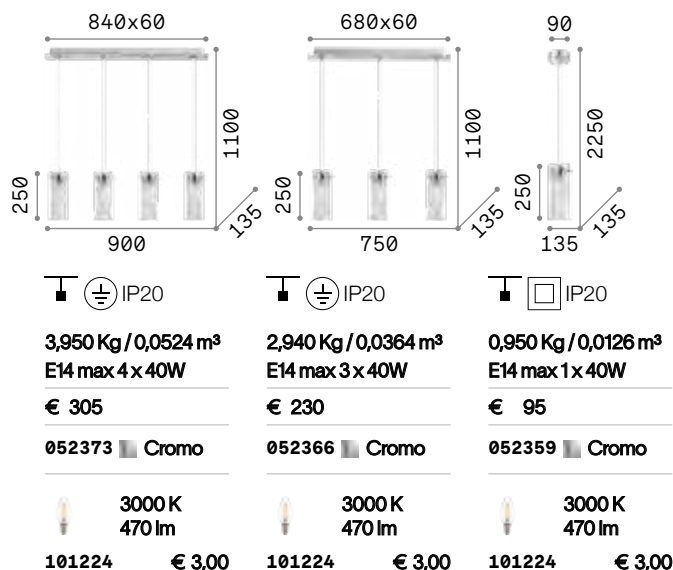

Gocce

Montatura in metallo cromato.
Diffusore in tubolare di vetro pirex.
Elementi decorativi con ottagoni
e gocce in cristallo molato. Cavi
elettrici regolabili in lunghezza.

LED Lampadine LED GU10 7W 3000 K
includ. Cod. 123943

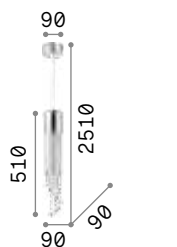

IP20

1,140 Kg / 0,0123 m³
GU10 max 1 x 28W

€ 130

089669 Cromo

3000 K
610 lm

123943 € 4,50





Cono

Montatura e copri porta lampade in metallo cromato. Diffusore in vetro soffiato a mano. Disponibile in cromo con vetro tutto trasparente.

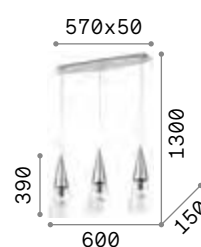

IP20

4,110 Kg / 0,0763 m³
E14 max 3 x 40W

€ 300

112367 Cromo

3000 K
300 lm

101255 € 4,50

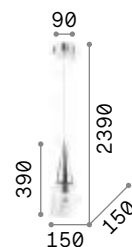

IP20

1,420 Kg / 0,0243 m³
E14 max 1 x 40W

€ 120

017440 Cromo

3000 K
300 lm

101255 € 4,50



Kuky

Montatura in metallo cromato.
Disponibile con vetro pirex smerigliato a sabbia nella zona centrale o vetro bianco soffiato e acidato.

IP20	IP20	IP20
4,580 Kg / 0,0766 m³ E27 max 4 x 60W	2,510 Kg / 0,0464 m³ E27 max 3 x 60W	0,980 Kg / 0,0165 m³ E27 max 1 x 60W
€ 240	€ 170	€ 58
023038 Trasparen.	033952 Trasparen.	023021 Trasparen. 053448 Bianco
3000 K 910 lm	3000 K 910 lm	3000 K 910 lm
119571 € 7,00	119571 € 7,00	119571 € 7,00



023021

053448



Milk

Base ellittica in metallo smaltato bianco. Diffusore in vetro bianco soffiato e acidato. Cavi elettrici regolabili in lunghezza.

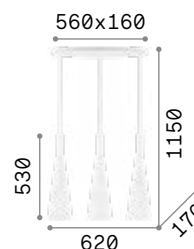

⏏ IP20

4,220 Kg / 0,1024 m³
E27 max 3 x 60W

€ 265

030326 Bianco

💡 3000 K
900 lm

123899 € 7,00

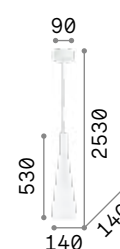

⏏ IP20

1,270 Kg / 0,0354 m³
E27 max 1 x 60W

€ 105

026787 Bianco

💡 3000 K
900 lm

123899 € 7,00



Cocktail

Diffusore in vetro soffiato incamiciato e acidato. Bianco all'interno e colorato all'esterno. Sospensioni con cavi a lunghezza regolabile.

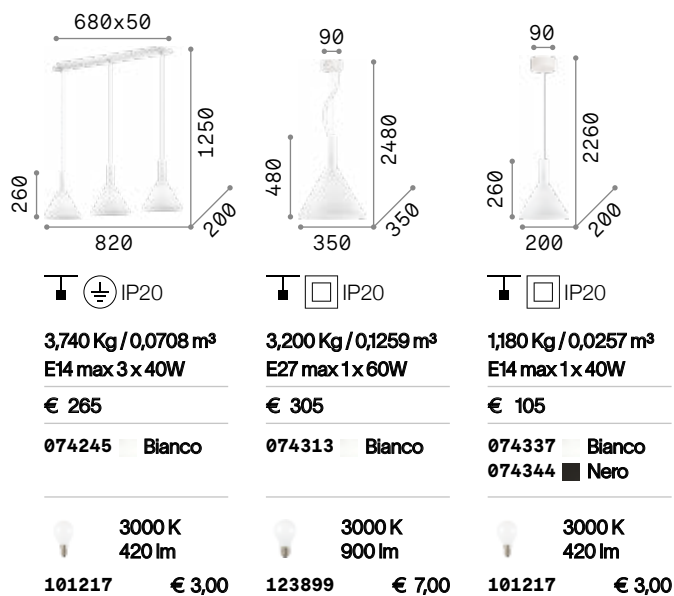



Tristan

Rosone e corpo luce in metallo verniciato a polveri. Paralume in acrilico trasparente rigato. Diffusore in policarbonato satinato. Cavo in pvc trasparente. Disponibile nelle finiture bianco, nero o oro metallizzato.

LED Sorgente luminosa LED 3000 K, 20.000 h di durata.



256429

256436

256443

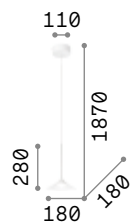

IP20

0,430 Kg / 0,0099 m³
LED 5W / 540 lm

€ 125

256429 ■ Bianco
256436 ■ Nero
256443 ■ Oro



Olimpia

Montatura in cromo. Diffusore in vetro colorato soffiato e incamiciato. Cavo elettrico regolabile in lunghezza.



013244

012919

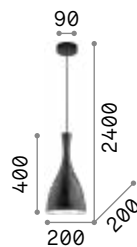

IP20

1,080 Kg / 0,0374 m³
E27 max 1x 60W

€ 144

013244 ■ Bianco
012919 ■ Nero

3000 K
900 lm

123899 € 7,00



Manhattan

Rosone e diffusore in metallo rifinito con vernice opaca bianca o nera e con dettaglio in legno naturale. Cavo in tessuto.

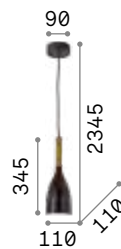

IP20

0,560 Kg / 0,0061 m³
E14 max 1x40W

€ 75

110745 ■ Bianco
110752 ■ Nero

3000 K
480 lm
101200 € 3,00



110745

110752



Flut

Diffusore in vetro soffiato incamiciato e acidato, bianco all'interno e colorato all'esterno. Cavo a lunghezza regolabile.

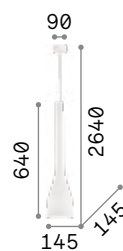

IP20

1,570 Kg / 0,0422 m³
E27 max 1x 60W

€ 140

035666 ■ Bianco
035680 ■ Nero

3000 K
900 lm

123899 € 7,00

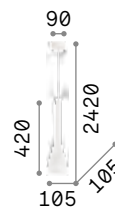

IP20

0,930 Kg / 0,0179 m³
E14 max 1x 40W

€ 75

035697 ■ Bianco
035710 ■ Nero
035703 ■ Rosso

3000 K
420 lm

101217 € 3,00



Origami

Montatura in metallo verniciato opaco. Diffusori in vetro bianco soffiato e acidato con effetto piegature in rilievo.

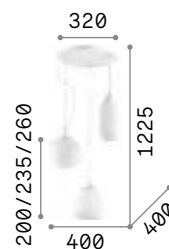

⏏ ⚡ IP20

3,740 Kg / 0,0642 m³
E27 max 3 x 60W

€ 280

198095 Bianco

💡 3000 K
900 lm

123899 € 7,00



Umile

Rosone ed elementi decorativi in metallo con finitura oro satinato. Diffusori in vetro soffiato bianco acidato. Led integrati.

LED Sorgente luminosa LED 3000 K, 20.000 h di durata.

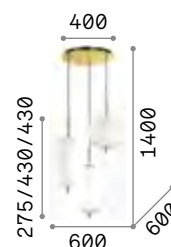

IP20

8,600 Kg / 0,2150 m³
LED 60,2W / 5300 lm

€ 415

224541 Bianco

Blossom

Montatura e rosone in metallo cromato. Diffusore in vetro soffiato trasparente con finitura ambra o fumè. Cavo elettrico in pvc trasparente.

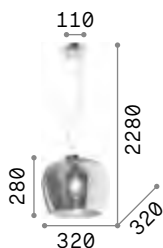

IP20

1,890 Kg / 0,0705 m³
E27 max 1x60W

€ 175

241517 ■ Fumè
241524 ■ Ambra

3000 K
900 lm

101354 € 8,50



241517



241524



Lord

Rosone e montatura in metallo verniciato a polveri con finitura nera. Cavo in pvc nero. Diffusore in vetro soffiato con decori in rilievo. Disponibile con vetro ambra, trasparente o fumè.

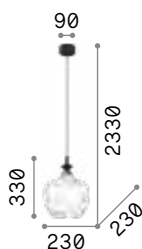

IP20

1,430 Kg / 0,0389 m³
E27 max 1x60W

€ 105

263632 ■ Trasparen.
263649 ■ Fumè
263656 ■ Ambra

3000 K
910 lm

119571 € 7,00





Fade

Rosone e montatura in metallo. Paralume in vetro soffiato trasparente con sfumatura galvanica. Diffusore interno in vetro soffiato bianco acidato. Cavo in pvc nero. Colori paralumi: trasparente con sfumatura ambra, cromo o rame.

LED Lampadine LED G9 3W 3000 K incluse. Cod. **209043**

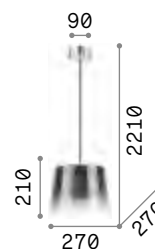

1,900 Kg / 0,0370 m³
G9 max 1x 15W

€ 200

- 271293 Cromo
- 271316 Ambra
- 271309 Rame

3000 K
370 lm
209043 € 3,90



Audi-20

Elemento centrale portalamпада in metallo cromato. Diffusore in vetro soffiato trasparente o cromo sfumato. Cavo in acciaio a lunghezza regolabile con dispositivo ferma cavo automatico.



016931



103990

LED

Lampadine LED E27 8W Globo D125
3000 K include. Cod. **101347/101354**

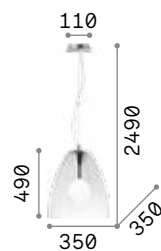

IP20

4,370 Kg / 0,1017 m³
E27 max 1x60W

€ 298

016931 Trasparen.
103990 Cromo sfum.

3000 K
900 lm

101354 € 8,50



Tolomeo

Diffusore in vetro soffiato, incamiciato e decorato a mano. Cavi in acciaio a lunghezza regolabile con dispositivi ferma cavo automatici.



001814



001821

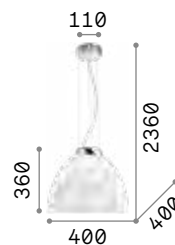

IP20

3,390 Kg / 0,0871 m³
E27 max 1x 60W

€ 280

001814 ■ Bianco
001821 ■ Grigio

3000 K
900 lm

101354 € 8,50



Karma

Montatura in metallo cromato.
 Diffusore in vetro soffiato bianco
 incamiciato e acidato. Cavi in
 acciaio a lunghezza regolabile da
 dispositivi ferma cavo automatici.

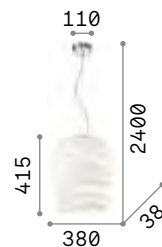

IP20

4,310 Kg / 0,1185 m³
 E27 max 1x 60W

€ 200

132365 Bianco

3000 K
 900 lm

101354 € 8,50

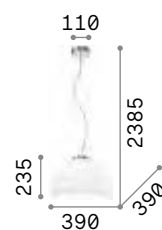

IP20

3,700 Kg / 0,0693 m³
 E27 max 1x 60W

€ 200

132389 Bianco

3000 K
 900 lm

101354 € 8,50



Folk

Rosone e diffusore in metallo decorato con effetto ossidato oppure con vernice opaca bianca. Parabola interna ondolata e smaltata. Cavo in tessuto.



174228



103136

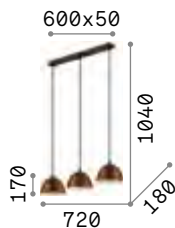

IP20

2,190 Kg / 0,0255 m³
E27 max 3 x 60W

€ 245

174235 ■ Corten

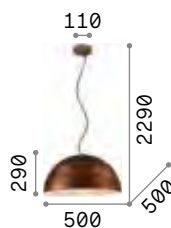

IP20

3,070 Kg / 0,0843 m³
E27 max 1 x 60W

€ 290

174228 ■ Corten
103136 ■ Bianco

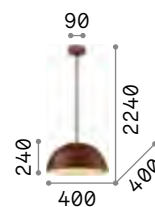

IP20

1,980 Kg / 0,0420 m³
E27 max 1 x 60W

€ 160

174211 ■ Corten
103112 ■ Bianco

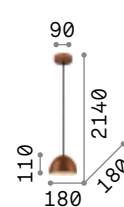

IP20

0,530 Kg / 0,0072 m³
E27 max 1 x 60W

€ 85

174204 ■ Corten

3000 K
340 lm
101286 € 3,00

3000 K
900 lm
101354 € 8,50

3000 K
950 lm
101330 € 8,00

3000 K
900 lm
123899 € 7,00

Aria

Diffusore in vetro bianco soffiato e acidato. Cavi in acciaio a lunghezza regolabile con dispositivi ferma cavo automatici.

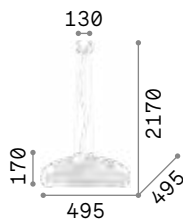

IP20

4,080 Kg / 0,0847 m³

E27 max 1x 60W

€ 285

059679 Bianco

3000 K
950 lm

101330 € 8,00



Mama

Montatura e anello sul bordo inferiore in metallo rifinito con smalto bianco satinato. Diffusore in vetro bianco soffiato e acidato. Cavi in acciaio a lunghezza regolabile da dispositivi automatici.

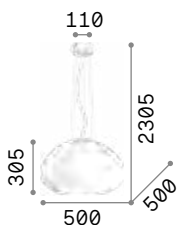

IP20

4,170 Kg / 0,1223 m³
E27 max 3x 60W

€ 370

071022 Bianco

3000 K
900 lm

101354 € 8,50



IP20

2,810 Kg / 0,0722 m³
E27 max 1x 60W

€ 196

071015 Bianco

3000 K
950 lm

101330 € 8,00





Plissé

Montatura in metallo placcato.
 Diffusore in vetro soffiato bianco acidato, con decoro in rilievo. Cavo elettrico in pvc trasparente. Colori: cromo oppure ottone satinato.



285184



264547

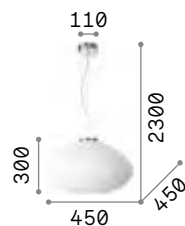

IP20

3,300 Kg / 0,1208 m³
 E27 max 1x60W

€ 250

264523 Cromo
 285191 Ottone

3000 K
 900 lm

123899 € 7,00

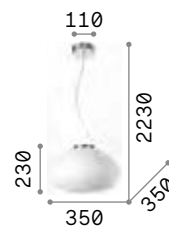

IP20

2,060 Kg / 0,0705 m³
 E27 max 1x60W

€ 185

285184 Cromo
 264547 Ottone

3000 K
 900 lm

123899 € 7,00



Lana

Diffusore in vetro trasparente con decorazioni serigrafate all'interno e sabbiate all'esterno. Ganci ferma vetro in metallo cromato.

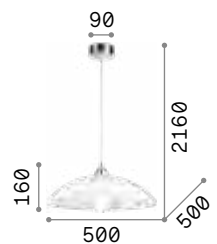

IP20

2,720 Kg / 0,0533 m³
E27 max 1x60W

€ 116

068169 Bianco

3000 K
950 lm

101330 € 8,00





Lena

Montatura in metallo cromato.
 Diffusore con doppio vetro:
 smerigliato e colorato quello
 esterno, bianco quello interno.
 Sospensioni con cavi in acciaio a
 lunghezza regolabile da dispositivi
 automatici.

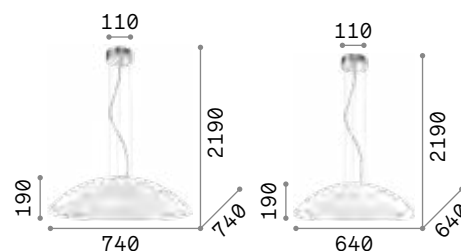

IP20

8,310 Kg / 0,1785 m³
 E27 max 3x 60W

€ 390

052786 Bianco

3000 K
 340 lm

101286 € 3,00

IP20

6,600 Kg / 0,1304 m³
 E27 max 3x 60W

€ 335

035727 Bianco
 066592 Grigio
 066608 Coffee

3000 K
 340 lm

101286 € 3,00



035727



066592



066608



Smarties

Montatura in metallo verniciato bianco. Diffusore in vetro bianco soffiato. Cavi in acciaio a lunghezza regolabile con dispositivi ferma cavo automatici.

IP20	IP20	IP20
5,280 Kg / 0,1479 m ³ E27 max 5 x 60W	3,740 Kg / 0,1009 m ³ E27 max 3 x 60W	2,930 Kg / 0,0645 m ³ E27 max 3 x 60W
€ 290	€ 200	€ 175
031996 Bianco	032009 Bianco	032016 Bianco
3000 K 340 lm	3000 K 340 lm	3000 K 340 lm
101286 € 3,00	101286 € 3,00	101286 € 3,00



P. 283



P. 375



P. 460



Glory

Montatura rifinita in nickel satinato. Diffusore in vetro bianco soffiato e acidato. Sospensioni con cavi in acciaio regolabili in lunghezza con dispositivi automatici.

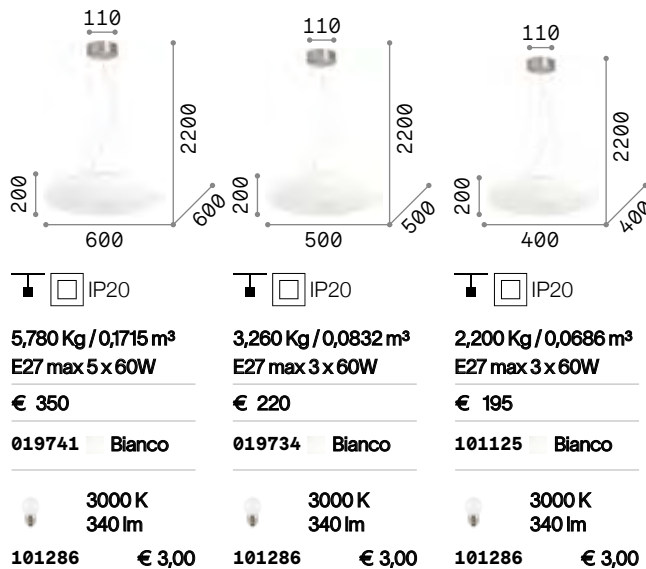

Ulisse

Montatura in metallo verniciato bianco opaco. Diffusore in vetro bianco soffiato e acidato. Sospensioni con cavi in acciaio a lunghezza regolabile da dispositivi automatici.

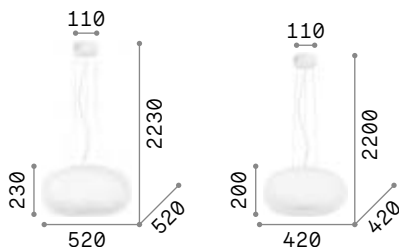

IP20

IP20

5,010 Kg / 0,1177 m³
E27 max 3 x 60W

3,110 Kg / 0,0720 m³
E27 max 3 x 60W

€ 295

€ 225

098616 Bianco

095226 Bianco

3000 K
910 lm

3000 K
910 lm

119571 € 7,00

119571 € 7,00



Arizona

Montatura in metallo rifinito in ottone satinato. Diffusore in vetro bianco soffiato, acidato e con rigature decorative in rilievo.

LED Lampadine LED GX53 9W 3000 K incluse. Cod. **123936**

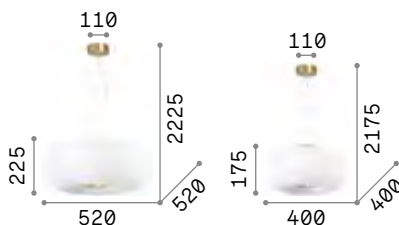

IP20

IP20

6,190 Kg / 0,1288 m³
GX53 max 5 x 15W

3,260 Kg / 0,0740 m³
GX53 max 3 x 15W

€ 520

€ 395

214481 Bianco

214474 Bianco

3000 K
910 lm

3000 K
910 lm

123936 € 6,00

123936 € 6,00



P. 284





Candy

Montatura in metallo bianco.
Diffusore in vetro bianco soffiato e acidato. Cavi in acciaio a lunghezza regolabile con dispositivi ferma cavo automatici.

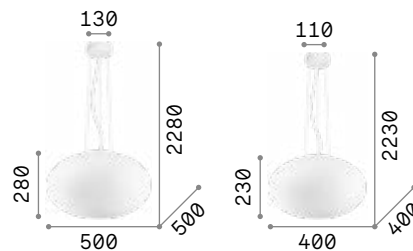

IP20

4,200 Kg / 0,1547 m³
E27 max 1x60W

€ 365

086743 Bianco

IP20

3,100 Kg / 0,0778 m³
E27 max 1x60W

€ 206

086736 Bianco

3000 K
900 lm

123899 € 7,00

3000 K
900 lm

123899 € 7,00



P. 285



P. 460



Clown

Montatura in metallo con diffusori in vetro soffiato e modellato a mano. Disponibile con montatura in cromo e vetri multicolor o con montatura e vetri bianchi.

LED

Lampadine LED G9 3W 3000 K incluse.
Cod. **209043**



100944



100883

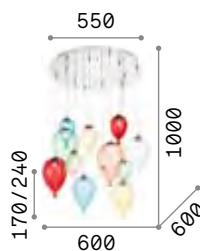

IP20 INCLUSA

6,000 Kg / 0,1860 m³
G9 max 12 x 28W

€ 750

100951 Color

3000 K
370 lm

209043 € 3,90

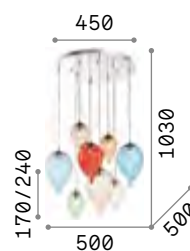

IP20 INCLUSA

5,700 Kg / 0,1442 m³
G9 max 8 x 28W

€ 545

100944 Color
100883 Bianco

3000 K
370 lm

209043 € 3,90

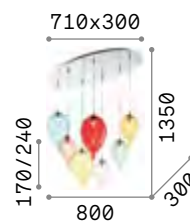

IP20 INCLUSA

5,000 Kg / 0,1283 m³
G9 max 7 x 28W

€ 493

100937 Color

3000 K
370 lm

209043 € 3,90

Bollicine

Elementi decorativi con bolle di vetro soffiato. Disponibile con bolle trasparenti e bianche o trasparenti e cromo.

LED Lampadine LED G9 3W 3000 K incluse.
Cod. **209043**



9,500 Kg / 0,2076 m³
G9 max 14 x 40W

€ 1250

087924 Bianco
093024 Cromo

3000 K
370 lm

209043 € 3,90



087924



093024



Mapa Plus

Montatura in metallo. Diffusore a sfera in vetro bianco soffiato e acidato. Cavi in acciaio a lunghezza regolabile.

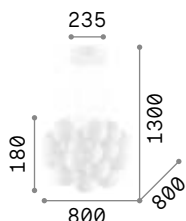

10,800 Kg / 0,1976 m³
E14 max 22 x 40W

€ 670

140230 Bianco

3000 K
420 lm

101217 € 3,00

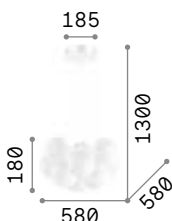

5,520 Kg / 0,1205 m³
E14 max 11 x 40W

€ 400

131924 Bianco

3000 K
420 lm

101217 € 3,00





Luce Max

Montatura in cromo. Diffusore in vetro soffiato con decorazione interna in filo d'alluminio. Sospensioni con cavo in acciaio a lunghezza regolabile da dispositivo ferma cavo automatico.

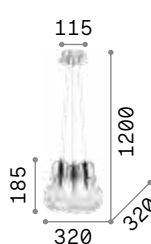

IP20

2,150 Kg / 0,0458 m³
E27 max 3 x 60W

€ 200

081762 Trasparen.

3000 K
910 lm

119571 € 7,00

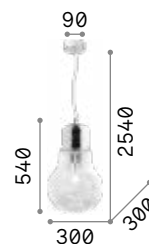

IP20

2,460 Kg / 0,0732 m³
E27 max 1 x 60W

€ 120

033662 Trasparen.

3000 K
910 lm

119571 € 7,00

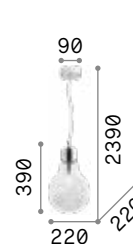

IP20

1,500 Kg / 0,0334 m³
E27 max 1 x 60W

€ 84

033679 Trasparen.

3000 K
910 lm

119571 € 7,00

Mapa Sat

Montatura in metallo con finitura nickel o ottone. Diffusore in vetro soffiato trasparente con decoro interno in filo d'alluminio.

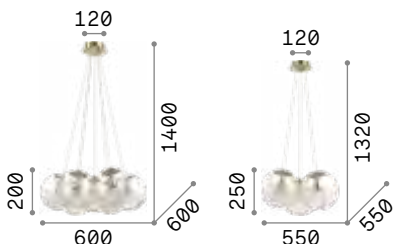

IP20

IP20

6,550 Kg / 0,1862 m³
E27 max 7x60W

2,700 Kg / 0,1210 m³
E27 max 3x60W

€ 520

€ 295

176062 ■ Nickel
176000 ■ Ottone

176031 ■ Nickel
175973 ■ Ottone

3000 K
910 lm

3000 K
910 lm

119571 € 7,00

119571 € 7,00



176031

175973



Mapa Max

Montatura in cromo. Diffusore in vetro soffiato con decorazione interna in filo d'alluminio. Sospensioni con cavo in acciaio a lunghezza regolabile da dispositivo ferma cavo automatico.

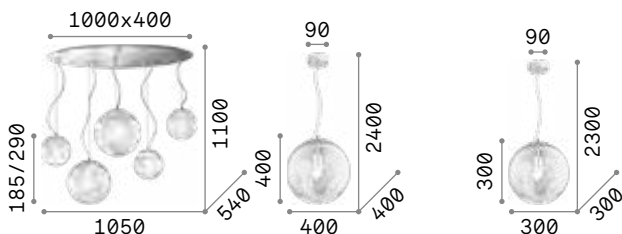

IP20

IP20

IP20

8,700 Kg / 0,2456 m³
E27 max 5x60W

3,450 Kg / 0,1370 m³
E27 max 1x60W

1,370 Kg / 0,0527 m³
E27 max 1x60W

€ 540

€ 166

€ 118

091112 ■ Cromo

045122 ■ Cromo

045115 ■ Cromo

3000 K
910 lm

3000 K
910 lm

3000 K
910 lm

119571 € 7,00

119571 € 7,00

119571 € 7,00

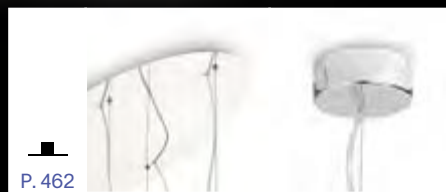

P. 462



Mapa Fade

Rosone e montatura in metallo cromato. Diffusore a sfera in vetro soffiato trasparente rifinito con cromatura sfumata verso il basso. Cavo in pvc trasparente. Colore: cromo.

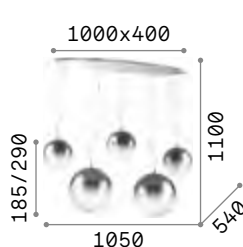

IP20

8,700 Kg / 0,2470 m³
E27 max 5x60W

€ 640

140759 CromoStum.

3000 K
910 lm

119571 € 7,00

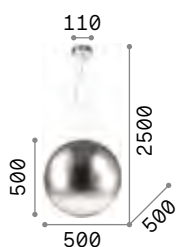

IP20

5,390 Kg / 0,2254 m³
E27 max 1x60W

€ 480

161327 CromoStum.

3000 K
910 lm

119571 € 7,00

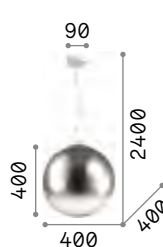

IP20

3,620 Kg / 0,1215 m³
E27 max 1x60W

€ 270

161334 CromoStum.

3000 K
910 lm

119571 € 7,00

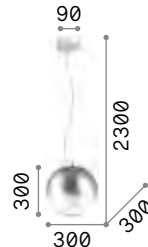

IP20

1,920 Kg / 0,0630 m³
E27 max 1x60W

€ 165

140728 CromoStum.

3000 K
910 lm

119571 € 7,00

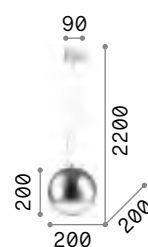

IP20

1,130 Kg / 0,0272 m³
E27 max 1x60W

€ 95

140711 CromoStum.

3000 K
910 lm

119571 € 7,00



Mapa Bianco

Montatura in metallo bianco.
Diffusore a sfera in vetro soffiato e acidato. Cavi in acciaio a lunghezza regolabile.

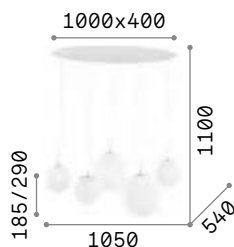

IP20

8,700 Kg / 0,2470 m³
E27 max 5x60W

€ 530

043562 Bianco

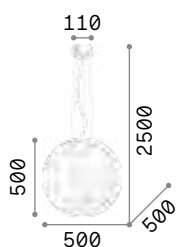

IP20

5,390 Kg / 0,2254 m³
E27 max 1x60W

€ 303

032122 Bianco

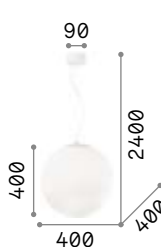

IP20

3,620 Kg / 0,1215 m³
E27 max 1x60W

€ 145

032139 Bianco

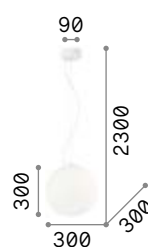

IP20

1,920 Kg / 0,0630 m³
E27 max 1x60W

€ 78

009087 Bianco

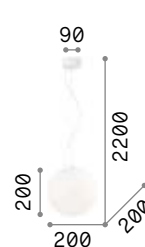

IP20

1,130 Kg / 0,0272 m³
E27 max 1x60W

€ 52

009148 Bianco



P. 284



P. 374



P. 461



3000 K
910 lm

119571

€ 7,00



3000 K
910 lm

119571

€ 7,00



3000 K
910 lm

119571

€ 7,00



3000 K
910 lm

119571

€ 7,00



3000 K
910 lm

119571

€ 7,00



Carta

Montatura in metallo verniciato bianco opaco. Diffusore in policarbonato con rivestimento ad effetto carta. Cavo rivestito in tessuto.

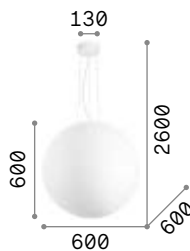
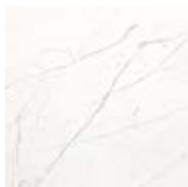

IP20

2,750 Kg / 0,2746 m³
E27 max 1x60W

€ 475

272139 Bianco

3000 K
2180 lm

151786 € 8,00

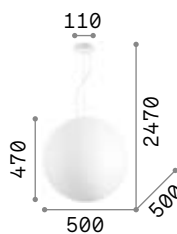

IP20

1,780 Kg / 0,1662 m³
E27 max 1x25W

€ 360

226040 Bianco

3000 K
950 lm

101330 € 8,00

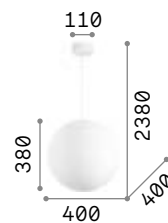

IP20

1,460 Kg / 0,0911 m³
E27 max 1x25W

€ 225

226033 Bianco

3000 K
950 lm

101330 € 8,00

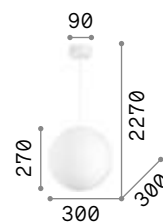

IP20

0,860 Kg / 0,0428 m³
E27 max 1x25W

€ 110

226026 Bianco

3000 K
950 lm

101330 € 8,00

Boa

Montatura in metallo verniciato opaco bianco o nero. Cavo in tessuto da 12 metri con 6 supporti. Diffusore in vetro soffiato bianco acidato.

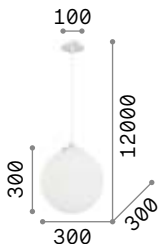

IP20

2,900 Kg / 0,0726 m³

E27 max 1x60W

€ 155

160863 Bianco

160856 Nero

3000 K
900 lm

123899 € 7,00



160863



160856



Mapa Riga

Montatura in metallo bianco. Diffusore a sfera in vetro soffiato bianco con decorazione dipinta. Cavi in acciaio a lunghezza regolabile.

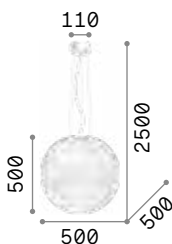

IP20

5,390 Kg / 0,2254 m³

E27 max 1x60W

€ 370

161365 Bianco

3000 K
910 lm

119571 € 7,00

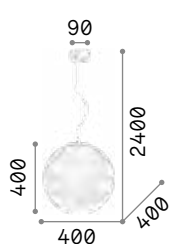

IP20

3,620 Kg / 0,1215 m³

E27 max 1x60W

€ 260

161372 Bianco

3000 K
910 lm

119571 € 7,00

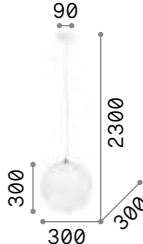

IP20

1,920 Kg / 0,0630 m³

E27 max 1x60W

€ 140

161389 Bianco

3000 K
910 lm

119571 € 7,00





Grape

Montatura in metallo rifinito ottone satinato. Cavi rivestiti in tessuto. Diffusore in vetro soffiato bianco con striature satinate.



LED Lampadine LED G9 3W 3000 K incluse nel modello **241340**. Cod. **209043**



IP20

3,300 Kg / 0,0639 m³
G9 max 3 x 28W

€ 270

241340 Bianco

3000 K
370 lm

209043 € 3,90



IP20

3,080 Kg / 0,1303 m³
E27 max 1 x 60W

€ 235

241364 Bianco

3000 K
900 lm

123899 € 7,00

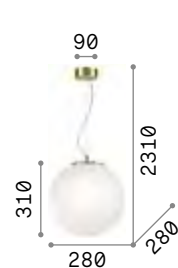

IP20

2,500 Kg / 0,0693 m³
E27 max 1 x 60W

€ 165

241357 Bianco

3000 K
900 lm

123899 € 7,00



Nemo Plus

Montatura in cromo. Diffusore in vetro soffiato con finitura in cromo sfumato. Cavi in acciaio a lunghezza regolabile da dispositivo ferma cavo automatico.

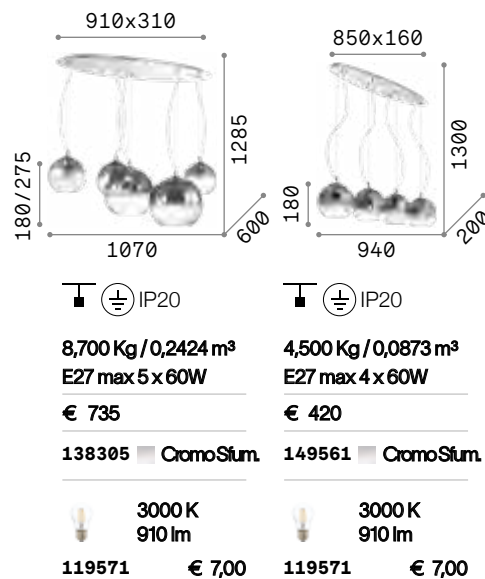













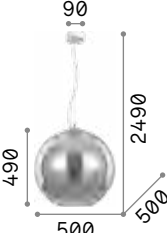
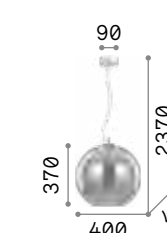
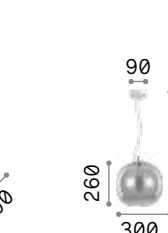
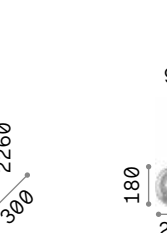
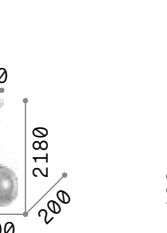





















Nemo

Diffusore in vetro soffiato.
Disponibile in versione fumé,
trasparente, rame o cromo
sfumato. Modello 052793 con copri
lampada in vetro bianco soffiato e
acidato.

LED Lampadine LED G9 3W 3000 K incluse
nel modello **052793**. Cod. **209043**

				
052809	149592	094236	250335	111902
				
 IP20	 IP20	 IP20	 IP20	 IP20 
4,000 Kg / 0,2220 m³ E27 max 1x60W	3,490 Kg / 0,1227 m³ E27 max 1x60W	2,960 Kg / 0,0664 m³ E27 max 1x60W	1,300 Kg / 0,0241 m³ E27 max 1x60W	1,080 Kg / 0,0241 m³ G9 max 1x40W
€ 450	€ 270	€ 190	€ 95	€ 95
094137  Fumé	052816  Trasparen. 250359  Cromo Sfum. 094229  Fumé 250342  Cromo 111919  Rame	052809  Trasparen. 149592  Cromo Sfum. 094236  Fumé 250335  Cromo 111902  Rame	149585  Cromo Sfum. 250311  Fumé 250304  Cromo 250328  Rame	052793  Trasparen.
 3000 K 1020 lm	 3000 K 1020 lm	 3000 K 1120 lm	 3000 K 1120 lm	 3000 K 370 lm
101347 € 8,50	101347 € 8,50	101323 € 7,50	101323 € 7,50	209043 € 3,90



Dna

Rosone e montatura in metallo dorato. Diffusori in vetro incamiciato bianco, soffiato e acidato. Cavi d'acciaio regolabili.



Lampadine LED G9 3W 3000 K incluse.
Cod. **209043**

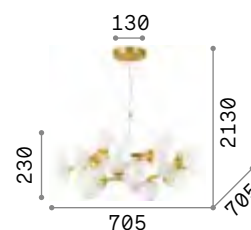

4,930 Kg / 0,2034 m³
G9 max 25 x 15W

€ 1100

208398 **Bianco**

3000 K
370 lm

209043 **€ 3,90**



Nodi

Montatura in metallo cromato oppure in ottone satinato. Diffusori in vetro bianco soffiato, acidato o trasparente e cromato.



082073



200491



241012

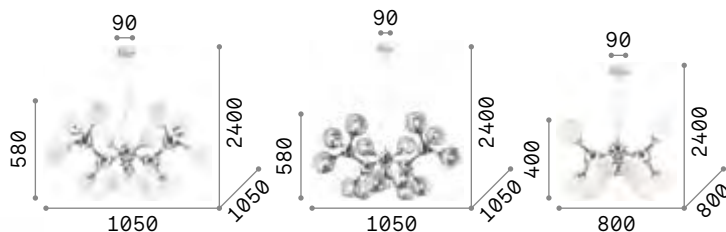

8,000 Kg / 0,3063 m³
E14 max 15 x 40W

€ 630

082073 ■ Bianco
241012 ■ Ottone



8,000 Kg / 0,4651 m³
E14 max 15 x 40W

€ 800

200491 ■ Cromo



5,300 Kg / 0,1480 m³
E14 max 9 x 40W

€ 430

082059 ■ Bianco
241036 ■ Ottone



3000 K
480 lm

101200

€ 3,00



3000 K
480 lm

101200

€ 3,00



3000 K
480 lm

101200

€ 3,00



P. 316



Ovalino

Diffusore composto da elementi circolari in lastra di vetro curvata e acidata. Cavi in acciaio regolabili in lunghezza da dispositivi automatici.

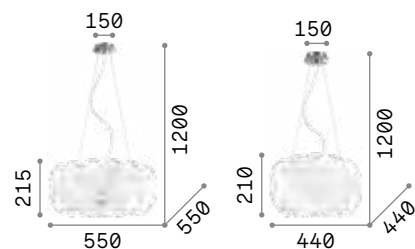

IP20

6,700 Kg / 0,1448 m³
E27 max 8 x 60W

€ 325

090481 Bianco

3000 K
900 lm

123899 € 7,00

IP20

4,810 Kg / 0,1184 m³
E27 max 5 x 60W

€ 255

074139 Bianco

3000 K
900 lm

123899 € 7,00



P. 286 P. 372



Basket

Montatura in metallo cromato.
Diffusore in spago ignifugo.
Sospensione a sfera con cavo in
acciaio regolabile in lunghezza da
dispositivo automatico.



0,800 Kg / 0,0911 m³
E27 max 1x60W

€ 150

096162 Bianco

 **3000 K**
900 lm

123899 **€ 7,00**



Dream Big

Rosone in metallo verniciato bianco opaco. Cavo in tessuto. Diffusore in vetro soffiato bianco acidato. Cesto in corda.

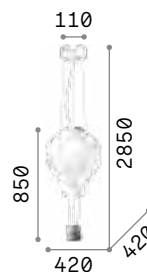

IP20

3,830 Kg / 0,1676 m³
E27 max 1x 42W

€ 265

261195 Bianco

3000 K
900 lm

123899 € 7,00

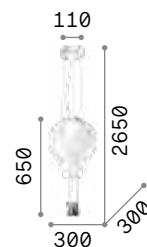

IP20

2,420 Kg / 0,1013 m³
E27 max 1x 42W

€ 155

179858 Bianco

3000 K
900 lm

123899 € 7,00

Avion

Corpo luce e rosone in legno dipinto con vernice opaca. Dettagli in metallo cromato. Diffusori in vetro soffiato bianco acidato.

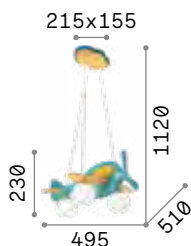

IP20

2,440 Kg / 0,0618 m³

E14 max 3x 40W

€ 190

136325 ■ Azzurro

136318 ■ Rosso

3000 K
420 lm

101217 € 3,00



Multiflex

Montatura in metallo rifinito con vernice opaca. Bracci flessibili rivestiti di gomma. Cavo in acciaio regolabile in lunghezza da dispositivo automatico.

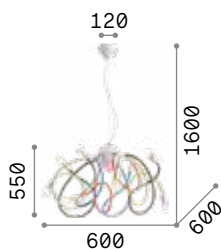

IP20

4,440 Kg / 0,0656 m³

E14 max 8x 40W

€ 400

141893 ■ Bianco

141909 ■ Color

3000 K
420 lm

101217 € 3,00



141893

141909



P. 322





Soft

Montatura in metallo con finiture bianco e cromo. Diffusori in vetro soffiato bianco o fumè.



087818



111841

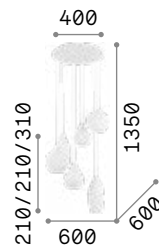

IP20

6,400 Kg / 0,1138 m³
E14 max 6 x 40W

€ 390

087818 ■ Bianco
111841 ■ Fumè

3000 K
420 lm

101217 € 3,00

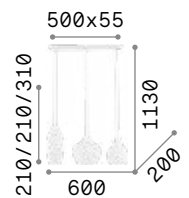

IP20

3,000 Kg / 0,0657 m³
E14 max 3 x 40W

€ 220

111858 ■ Bianco
111865 ■ Fumè

3000 K
420 lm

101217 € 3,00



Lido

Montatura in metallo cromato. Cavo in tessuto. Diffusori in vetro soffiato trasparente fumè.

LED Lampadine LED G9 3W 3000 K incluse.
Cod. **209043**

IP20 <small>INCLUSA</small>	IP20 <small>INCLUSA</small>	IP20 <small>INCLUSA</small>
0,790 Kg / 0,0180 m ³ G9 max 1x 15W	0,790 Kg / 0,0156 m ³ G9 max 1x 15W	0,660 Kg / 0,0243 m ³ G9 max 1x 15W
€ 78	€ 78	€ 88
168326 ■ Fumè	168357 ■ Fumè	168364 ■ Fumè
3000 K 370 lm 209043 € 3,90	3000 K 370 lm 209043 € 3,90	3000 K 370 lm 209043 € 3,90

Ken

Montatura in metallo cromato.
Diffusore in vetro soffiato. Cavi in acciaio a lunghezza regolabile con dispositivi ferma cavo automatici.

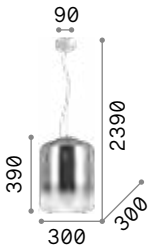

3,050 Kg / 0,0862 m³
E27 max 1x60W

€ 335

112107 CromoStum.

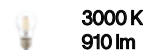

119571 € 7,00

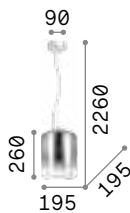

1,520 Kg / 0,0309 m³
E27 max 1x60W

€ 210

112084 CromoStum.

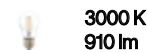

119571 € 7,00

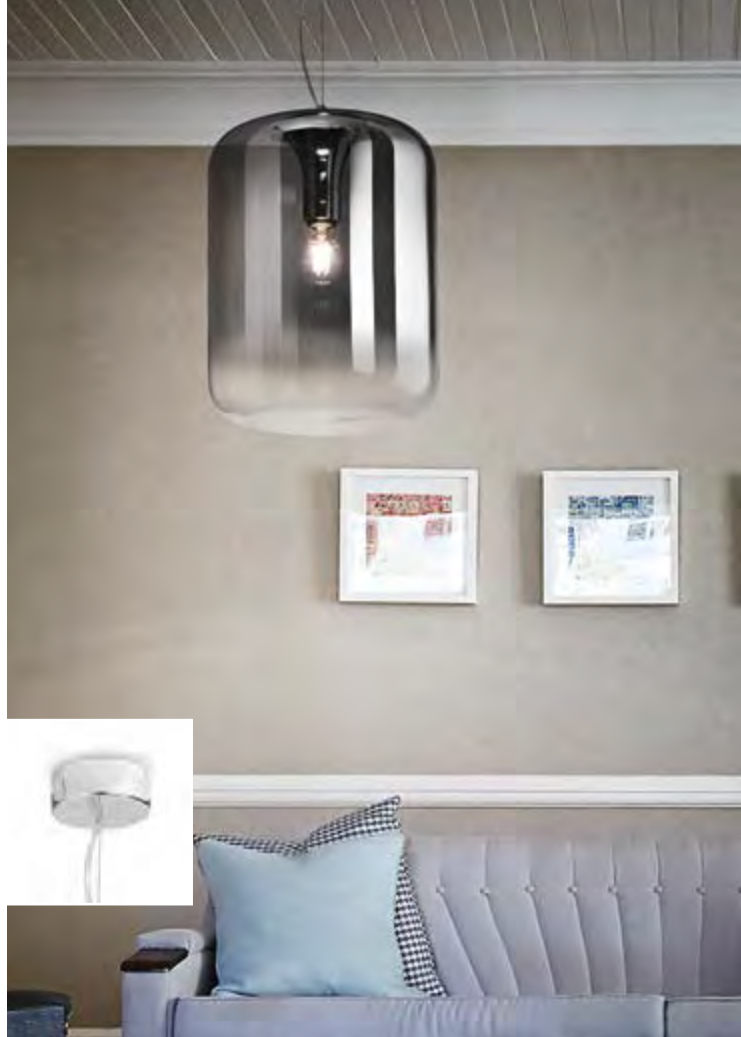

Coco

Montatura in metallo verniciato a polveri con finitura nera. Diffusore in acrilico trasparente con bordo laterale satinato. Vetro soffiato trasparente con finitura fumè. Cavo in pvc.

LED Sorgente luminosa LED 3000 K,
20.000 h di durata.

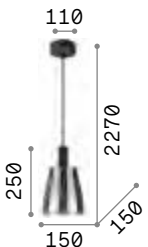

1,200 Kg / 0,0128 m³
LED 7W / 580 lm

€ 152

275567 Fumè

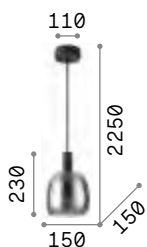

1,140 Kg / 0,0132 m³
LED 7W / 580 lm

€ 152

275581 Fumè

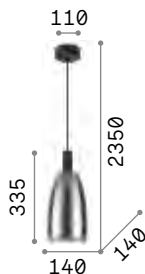

1,080 Kg / 0,0152 m³
LED 7W / 580 lm

€ 152

275543 Fumè



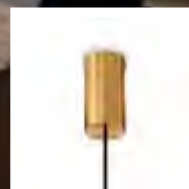

Decor new

Rosone e montatura in metallo con finitura ottone satinato. Diffusore trasparente in materiale acrilico decorato con effetto cristallo smerigliato. Cavo in pvc nero.

LED Sorgente luminosa LED 3000 K, 20.000 h di durata.

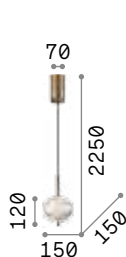

IP20

0,700 Kg / 0,0078 m³
LED 7W / 850 lm

€ 110

292076

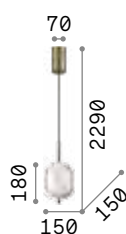

IP20

0,900 Kg / 0,0101 m³
LED 10W / 1300 lm

€ 125

292083

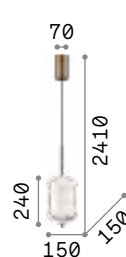

IP20

1,100 Kg / 0,0123 m³
LED 14W / 1750 lm

€ 145

292090

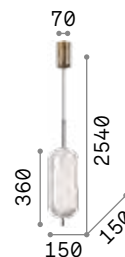

IP20

1,400 Kg / 0,0173 m³
LED 20W / 2600 lm

€ 180

292113



Trasparen.new 292083 Trasparen.new 292090 Trasparen.new 292113 Trasparen.new



Mint

Montatura in metallo con finitura ottone satinato e rosone nero opaco. Cavo rivestito in tessuto. Diffusore in vetro soffiato con rigatura in rilievo. Disponibile nelle finiture fumè o verde.



237510



237497

IP20	IP20	IP20
1,350 Kg / 0,0147 m³ E27 max 1x 60W	1,560 Kg / 0,0532 m³ E27 max 1x 60W	1,80 Kg / 0,0269 m³ E27 max 1x 60W
€ 105	€ 127	€ 138
237442 Fumè 248554 Verde	237398 Fumè 237428 Verde	237510 Fumè 237497 Verde
3000 K 910 lm	3000 K 910 lm	3000 K 910 lm
119571 € 7,00	119571 € 7,00	119571 € 7,00



Bergen

Rosone in metallo verniciato a polveri di colore nero. Montatura in legno naturale. Diffusore in vetro soffiato trasparente con motivo decorativo in rilievo e finitura fumè. Cavo rivestito in tessuto.

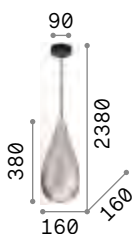
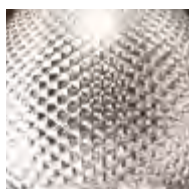

IP20

1,570 Kg / 0,0331 m³
E27 max 1x60W

€ 186

238838 ■ Fumè

3000 K
910 lm
119571 € 7,00

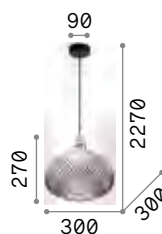

IP20

1,840 Kg / 0,0439 m³
E27 max 1x60W

€ 186

238920 ■ Fumè

3000 K
910 lm
119571 € 7,00

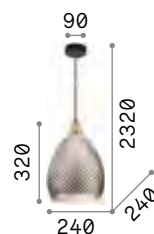

IP20

1,430 Kg / 0,0378 m³
E27 max 1x60W

€ 186

238746 ■ Fumè

3000 K
910 lm
119571 € 7,00



Bistrò

Montatura in metallo verniciato nero. Diffusore in vetro, ambra, trasparente o fumè, soffiato e modellato artigianalmente.



112305



112312



163789

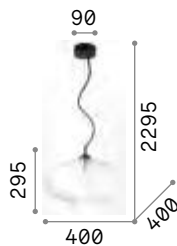

2,190 Kg / 0,0806 m³
E27 max 1x60W

€ 213

120898 Trasparen.
120904 Fumè

3000 K
910 lm

119571 € 7,00

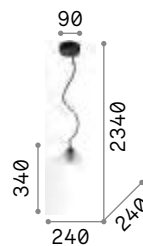

1,840 Kg / 0,0427 m³
E27 max 1x60W

€ 145

112305 Trasparen.
112312 Fumè
163789 Ambra

3000 K
910 lm

119571 € 7,00

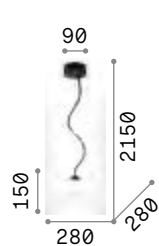

1,200 Kg / 0,0274 m³
E27 max 1x60W

€ 113

112336 Trasparen.
112343 Fumè

3000 K
910 lm

119571 € 7,00



Gretel

Montatura in metallo rifinito in vernice nera opaca con applicazione in legno naturale. Diffusori in vetro soffiato trasparente. Cavi in tessuto nero.

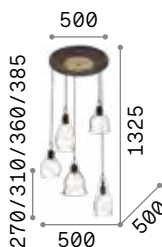

IP20

5,960 Kg / 0,1419 m³
E27 max 5 x 60W

€ 500

103174 ■ Nero

3000 K
910 lm
119571 € 7,00

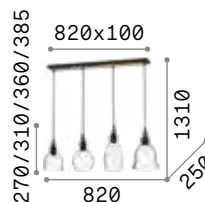

IP20

4,090 Kg / 0,0983 m³
E27 max 4 x 60W

€ 415

122557 ■ Nero

3000 K
910 lm
119571 € 7,00

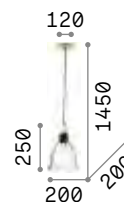

IP20

0,950 Kg / 0,0243 m³
E27 max 1 x 60W

€ 105

122564 ■ Nero

3000 K
910 lm
119571 € 7,00



Audi-10

Montatura in metallo cromato.
 Diffusore in vetro soffiato
 trasparente o fumè. Cavi in
 acciaio a lunghezza regolabile con
 dispositivi ferma cavo automatici.

LED Lampadine LED E27 8W Globo D95
 3000 K incluse. Cod. **101330/101323**



016863



103983

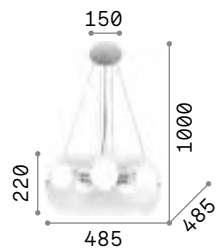

IP20 INCLUSA

5,520 Kg / 0,1044 m³
E27 max 5 x 60W

€ 425

016863 **Trasparen.**
103983 **Fumè**

3000 K
950 lm
101330 **€ 8,00**



Audi-80

Montatura in metallo cromato.
Elementi decorativi con sfere di vetro
su fili di metallo. Diffusore in vetro
soffiato trasparente o fumé. Cavi in
acciaio a lunghezza regolabile con
ferma cavo automatici.



031743



197661

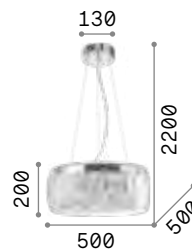

9,560 Kg / 0,1289 m³
G9 max 8 x 40W

€ 620

031750 Trasparen.
197654 Fumé

3000 K
370 lm

209043 € 3,90

5,890 Kg / 0,0876 m³
G9 max 5 x 40W

€ 445

031743 Trasparen.
197661 Fumé

3000 K
370 lm

209043 € 3,90

LED

Lampadine LED G9 3W 3000 K incluse.
Cod. 209043



Madame

Rosone in metallo verniciato opaco bianco o nero. Cavo in tessuto. Diffusore con telaio metallico avvolto da nastro in tessuto di raso bianco, canvas o nero.



174396



219875



174402

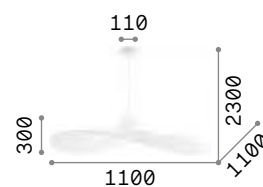

IP20

2,560 Kg / 0,2012 m³
E27 max 1x60W

€ 385

174396 ■ Bianco
219875 ■ Avorio
174402 ■ Nero

3000 K
900 lm

101354 € 8,50



Phoenix

Montatura in metallo cromato. Paralume con telaio in metallo e rivestimento in tessuto. Elementi decorativi con catene di ottagoni in cristallo molato. Sospensioni con cavi in acciaio regolabili in lunghezza da dispositivi automatici.



099101



101163

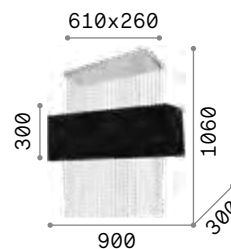

IP20

8,400 Kg / 0,1030 m³
E27 max 5 x 60W

€ 850

099101 ■ Bianco
101163 ■ Nero

3000 K
900 lm

123899 € 7,00

London

Montatura in metallo cromato. Paralume in lamina di PVC cromata e semi trasparente. Per la sospensione, cavi in acciaio a lunghezza regolabile con dispositivi ferma cavo automatici.

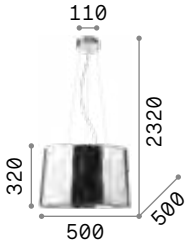

2,950 Kg / 0,1055 m³
E27 max 5 x 60W

€ 230

032351 Cromo



3000 K
910 lm

119571

€ 7,00



P. 471



P. 521



Nordik

Montatura in metallo verniciato nero opaco. Paralume in lamina di PVC dorato rivestito in tessuto nero.



1,760 Kg / 0,1694 m³
E27 max 6 x 60W

€ 280

161662 Nero



3000 K
910 lm

119571

€ 7,00

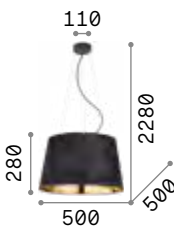

1,500 Kg / 0,1064 m³
E27 max 4 x 60W

€ 210

161648 Nero



3000 K
910 lm

119571

€ 7,00



P. 428



P. 472



P. 524



Cylinder

Montatura in metallo. Diffusore in vetro soffiato bianco acidato. Cavi in acciaio a lunghezza regolabile con dispositivi ferma cavo automatici.

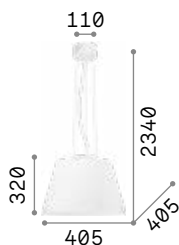

4,040 Kg / 0,0729 m³

E27 max 1x60W

€ 235

025438 Bianco

3000 K
900 lm

101354 € 8,50



P. 524



Cloe

Rosone e paralume in metallo verniciato a polveri. Diffusore in policarbonato opale. Cavo in pvc trasparente. Colori: nero.

LED Sorgente luminosa LED 3000 K, 50.000 h di durata.

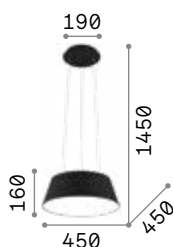

2,040 Kg / 0,0622 m³

LED 43W / 5700 lm

€ 320

247304 Nero



Woody

Montatura in metallo cromato.
Diffusore in PVC o in tessuto,
chiuso sul fondo da vetro
trasparente acidato. Sospensioni
con cavi regolabili in lunghezza.

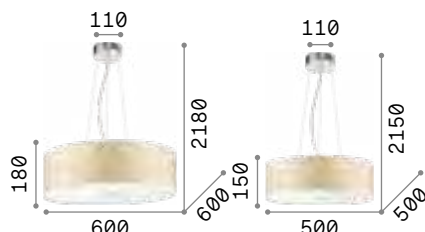

6,150 Kg / 0,1352 m³
E27 max 5 x 60W

4,000 Kg / 0,0832 m³
E27 max 4 x 60W

€ 250

€ 210

103242 ■ Bianco
105628 ■ Nero
087719 ■ Legno

122236 ■ Bianco
122243 ■ Nero
087702 ■ Legno

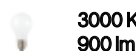

123899 € 7,00

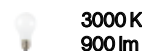

123899 € 7,00



P. 292



P. 427



Wheel

Montatura circolare in metallo
smaltato. Paralume in lamina di
PVC rivestita di tessuto. Cavi in
acciaio a lunghezza regolabile con
dispositivi ferma cavo automatici.

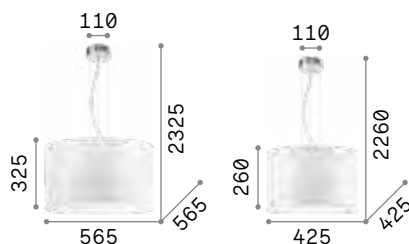

2,810 Kg / 0,1412 m³
E27 max 5 x 60W

2,020 Kg / 0,0614 m³
E27 max 3 x 60W

€ 255

€ 135

009698 ■ Bianco

009681 ■ Bianco

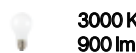

123899 € 7,00

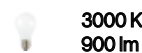

123899 € 7,00



P. 293





Hilton

Montatura in cromo. Paralume in lamina di PVC rivestita in tessuto. Sul fondo, diffusore in vetro trasparente sabbiato. Sospensioni con cavi a lunghezza regolabile.

LED Lampadine LED G9 3W 3000 K incluse nel modello **075495**. Cod. **209043**

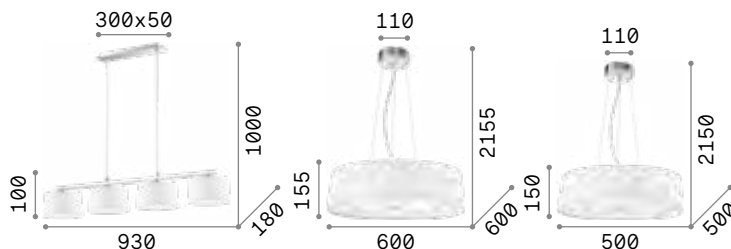

2,850 Kg / 0,0374 m³
G9 max 4x40W

€ 225

075495 Bianco

3000 K
370 lm

209043 € 3,90



5,980 Kg / 0,1183 m³
E27 max 6x60W

€ 270

075518 Bianco

3000 K
900 lm

123899 € 7,00



3,480 Kg / 0,0817 m³
E27 max 4x60W

€ 195

075501 Bianco

3000 K
900 lm

123899 € 7,00



P. 426 P. 473 P. 527



P. 290 P. 424 P. 476 P. 522

Set up new

Montature in metallo verniciato a polveri o placcato. Paralumi in pvc ignifugo rivestito di tessuto. Colori montature: bianco, nero oppure nichel satinato o ottone spazzolato. Colori paralumi: beige, tortora, bianco o nero.

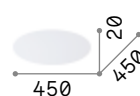
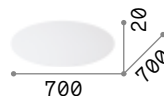
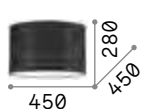
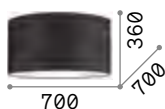
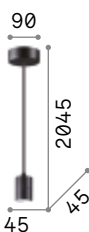

IP20

0,350 Kg / 0,0019 m³
E27 max 1x60W

€ 29

- 260013 Bianco
- 260044 Nickel
- 260020 Nero
- 260051 Ottone

1,260 Kg / 0,2131 m³

€ 116

- 260471 Bianco
- 304632 Tortora new
- 270029 Nero
- 260488 Beige

0,047 Kg / 0,0221 m³

€ 85

- 260457 Bianco
- 304625 Tortora new
- 270012 Nero
- 260464 Beige

0,700 Kg / 0,0259 m³

€ 50

- 270050 Trasparen.

0,280 Kg / 0,0108 m³

€ 30

- 270043 Trasparen.

3000 K
900 lm
123899 € 7,00



Opera

Montatura in cromo. Paralume in lamina di PVC con riflessi metallizzati e rivestita da fili. Pendagli in cristallo molato. Sospensioni con cavi in acciaio a lunghezza regolabile.

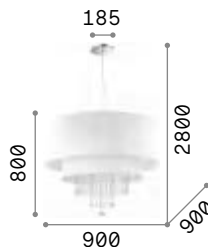

IP20

7,340 Kg / 0,3322 m³
E27 max 10 x 60W

€ 850

165011 Bianco

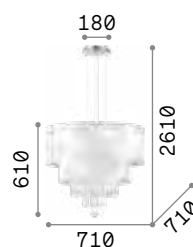

IP20

4,889 Kg / 0,1652 m³
E27 max 6 x 60W

€ 500

068299 Bianco

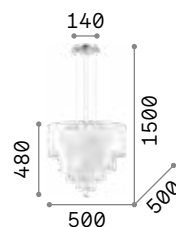

IP20

3,166 Kg / 0,0646 m³
E27 max 4 x 60W

€ 370

182179 Bianco



P. 434



P. 483



P. 529

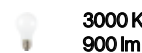

123899 € 7,00

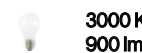

123899 € 7,00

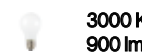

123899 € 7,00



Swan

Montatura in cromo. Corpo luce in vetro soffiato e lavorato a mano. Elementi decorativi in cristallo molato. Paralume in tessuto d'organza plissettato. Copricatena in velluto.

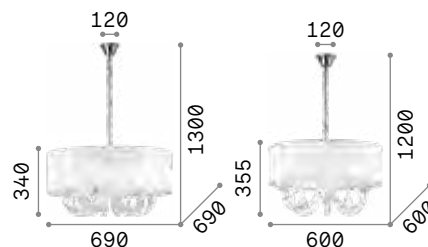

IP20

6,420 Kg / 0,2708 m³
E14 max 6x40W

€ 570

035826 Bianco

3000 K
420 lm

101217 € 3,00

IP20

4,770 Kg / 0,1632 m³
E14 max 3x40W

€ 400

035840 Bianco

3000 K
420 lm

101217 € 3,00



Calypso

Montatura in metallo cromato.
Elementi decorativi in cristallo molato.
Sospensioni con cavi in acciaio a lunghezza regolabile da dispositivi ferma cavo automatici.

LED Lampadine LED G9 3W 3000 K incluse nel modello **044187**. Cod. **209043**

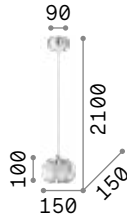
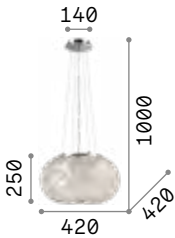

IP20

IP20

6,410 Kg / 0,0893 m³
E27 max 5 x 60W

1,130 Kg / 0,0138 m³
G9 max 1 x 40W

€ 680

€ 160

044200 Cromo

044187 Cromo

3000 K
430 lm
101279 € 3,00

3000 K
370 lm
209043 € 3,90



P. 432



King

Diffusore composto da anelli in metallo cromato o dorato con ottagononi di cristallo incastonati all'interno. Sospensioni con cavi in acciaio a lunghezza regolabile da dispositivi automatici.

LED Lampadine LED G9 3W 3000 K incluse. Cod. **209043**

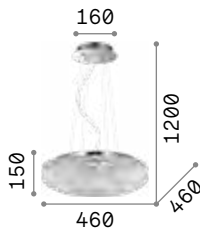
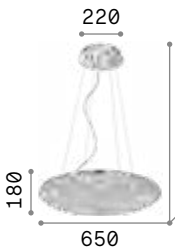

IP20

IP20

10,000 Kg / 0,1486 m³
G9 max 12 x 40W

5,300 Kg / 0,0748 m³
G9 max 7 x 40W

€ 1050

€ 670

088013 Cromo
088020 Oro

087979 Cromo

3000 K
370 lm
209043 € 3,90

3000 K
370 lm
209043 € 3,90



P. 334





Orion

Diffusore composto da anelli in metallo cromato con ottagoni di cristallo incastonati all'interno. Sospensioni con cavi in acciaio regolabili in lunghezza da dispositivi automatici.

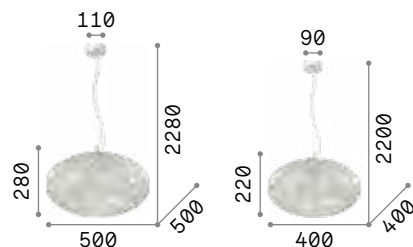

IP20

6,800 Kg / 0,1476 m³
E14 max 8 x 40W

€ 600

066387 Cromo

3000 K
480 lm

101200 € 3,00

IP20

4,600 Kg / 0,0875 m³
E14 max 6 x 40W

€ 440

059181 Cromo

3000 K
480 lm

101200 € 3,00



Versus

Montatura in metallo cromato.
Elementi decorativi con catenine
metalliche a maglia quadrata. Cavi
in acciaio regolabili in altezza da
dispositivi blocca cavo automatici.

LED Sorgente luminosa LED 3000 K,
30.000 h di durata.

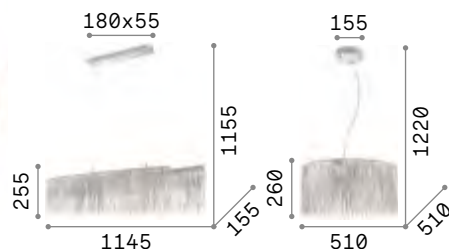

IP20

4,450 Kg / 0,0445 m³
LED 35W / 4300 lm

€ 750

137056 Cromo

IP20

3,200 Kg / 0,0370 m³
LED 24W / 3300 lm

€ 550

137032 Cromo

Rain

Montatura in metallo cromato.
 Pendagli con elementi in cristallo
 molato in varie forme e gocce finali.
 Sospensioni con cavi in acciaio a
 lunghezza regolabile.

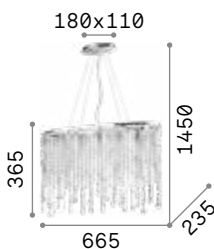

3,320 Kg / 0,0351 m³

E14 max 5 x 40W

€ 350

008363 Cromo

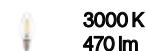

101224 € 3,00



P. 339 P. 482



Giada

Montatura in metallo cromato.
 Pendagli con elementi ottagonali
 e puntali finali in cristallo molato.
 Sospensioni con cavi in acciaio a
 lunghezza regolabile.

LED Lampadine LED G9 3W 3000 K incluse.
 Cod. 209043

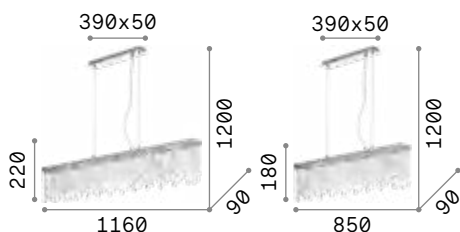

5,500 Kg / 0,0297 m³
 G9 max 7 x 40W

€ 570

098739 Trasparen.

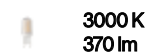

209043 € 3,90



4,000 Kg / 0,0217 m³
 G9 max 5 x 40W

€ 425

098722 Trasparen.

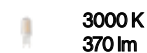

209043 € 3,90





Elisir

Montatura in metallo. Elementi decorativi a prisma in cristallo molato trasparente nella versione cromo, ambra in quella ottone.

LED Lampadine LED G9 3W 3000 K incluse.
Cod. **209043**



200002



200071

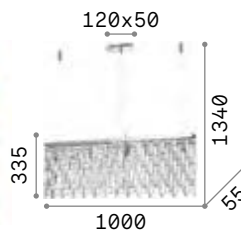

IP20

8,380 Kg / 0,0408 m³
G9 max 8 x 40W

€ 650

200002 **Cromo**
200071 **Ottone**

3000 K
370 lm

209043 € 3,90

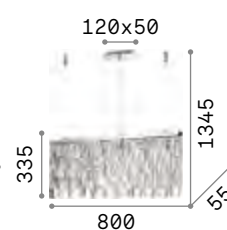

IP20

6,370 Kg / 0,0325 m³
G9 max 6 x 40W

€ 570

199993 **Cromo**
200064 **Ottone**

3000 K
370 lm

209043 € 3,90



Martinez

Montatura in metallo cromato o dorato. Elementi decorativi con catene di ottagononi e barre in cristallo molato trasparente.



166360



213583

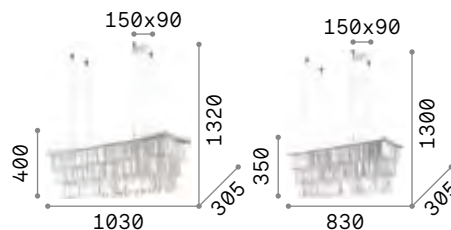

IP20

17,600 Kg / 0,1129 m³
E14 max 8 x 40W

€ 745

166360 Cromo
213583 Oro

IP20

14,490 Kg / 0,0723 m³
E14 max 6 x 40W

€ 632

166322 Cromo

3000 K
470 lm

101224 € 3,00

3000 K
470 lm

101224 € 3,00





Carlton

Montatura in metallo cromato o dorato. Elementi decorativi con catene di ottagoni e barre in cristallo molato trasparente.



166247



213521

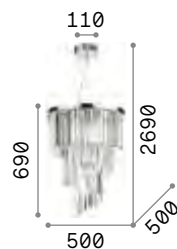

IP20

12,800 Kg / 0,1614 m³
E14 max 12 x 40W

€ 660

166247 Cromo
213521 Oro

3000 K
470 lm

101224 € 3,00

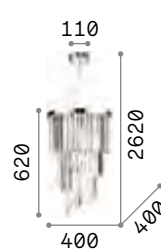

IP20

10,000 Kg / 0,1136 m³
E14 max 8 x 40W

€ 550

117737 Cromo

3000 K
470 lm

101224 € 3,00



Roma

Montatura e dettagli in metallo cromato. Diffusore con elementi quadrati in cristallo molato sulla fascia laterale e vetro sabbato sul fondo. Sospensioni con cavi a lunghezza regolabile.

LED Lampadine LED G9 3W 3000 K incluse.
Cod. **209043**

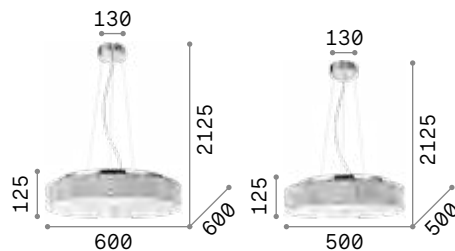

10,00 Kg / 0,1202 m³
G9 max 12 x 40W

€ 800

093062 Cromo

3000 K
370 lm

209043 € 3,90



7,100 Kg / 0,0890 m³
G9 max 9 x 40W

€ 650

093048 Cromo

3000 K
370 lm

209043 € 3,90



P. 332 P. 432 P. 482



Nabucco

Montatura in metallo con finitura oro. Elementi decorativi in cristallo trasparente molato. Quadrati nella parte superiore e a losanga in quella inferiore.

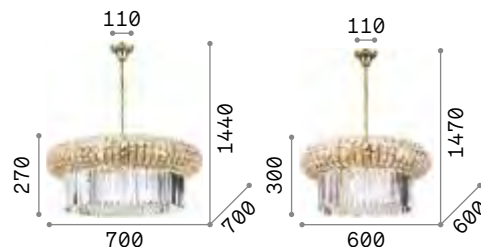

IP20

18,730 Kg / 0,2127 m³
E14 max 16 x 40W

€ 880

237800 Oro

3000 K
480 lm

101200 € 3,00

IP20

13,810 Kg / 0,1383 m³
E14 max 12 x 40W

€ 770

237794 Oro

3000 K
480 lm

101200 € 3,00



Pashà

Montatura in metallo. Diffusore composto da filari di perle in cristallo molato e fondo chiuso da vetro circolare sabbato. Cavi in acciaio a lunghezza regolabile con dispositivi fermacavo automatici.



164977



164984



P. 333 P. 432

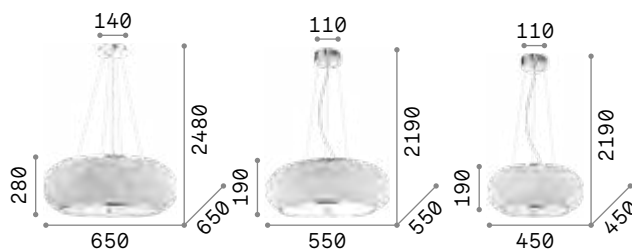

13,000 Kg / 0,1777 m³
E14 max 14 x 40W

€ 1210

164977 Cromo
164984 Oro

3000 K
480 lm

101200 € 3,00



8,500 Kg / 0,1134 m³
E14 max 10 x 40W

€ 950

082196 Cromo
082257 Oro

3000 K
480 lm

101200 € 3,00



5,350 Kg / 0,0573 m³
E14 max 6 x 40W

€ 750

082158 Cromo
082172 Oro

3000 K
480 lm

101200 € 3,00



Luxor

Montatura in metallo cromato.
Diffusore con elementi decorativi
ottagonali e rettangolari in cristallo
molato. Copricatena in velluto.

LED Lampadine LED G9 3W 3000 K incluse.
Cod. **209043**

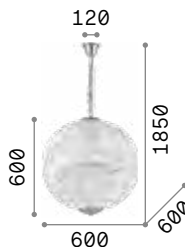

12,250 Kg / 0,3097 m³
G9 max 12 x 40W

€ 1320

116235 ■ Cromo

3000 K
370 lm
209043 € 3,90

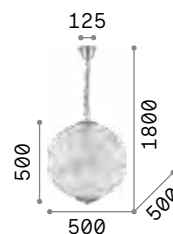

8,780 Kg / 0,2054 m³
G9 max 8 x 40W

€ 940

116228 ■ Cromo

3000 K
370 lm
209043 € 3,90

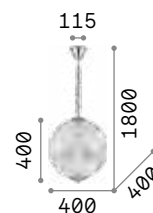

8,340 Kg / 0,1260 m³
G9 max 6 x 40W

€ 720

092911 ■ Cromo

3000 K
370 lm
209043 € 3,90

Evasione

Pendagli in cristallo molato.
Sospensioni con cavo in acciaio a
lunghezza regolabile da dispositivo
fermacavo automatico.

LED Lampadine LED G9 3W 3000 K incluse.
Cod. 209043

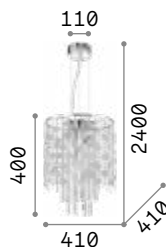
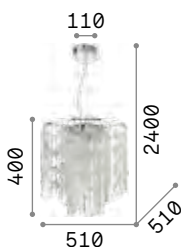

7,100 Kg / 0,1082 m³
G9 max 10 x 40W

5,900 Kg / 0,0706 m³
G9 max 8 x 40W

€ 570

€ 470

044767 Cromo

044774 Cromo

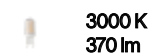
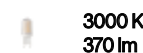

209043 € 3,90

209043 € 3,90



Audi-77

Pendagli ottagonali e tondi in
cristallo molato. Sospensioni con
cavi a lunghezza regolabile da
dispositivi automatici.

LED Lampadine LED G9 3W 3000 K incluse.
Cod. 209043

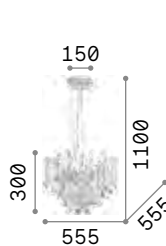
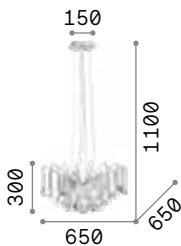

6,550 Kg / 0,1347 m³
G9 max 8 x 40W

5,230 Kg / 0,1044 m³
G9 max 6 x 40W

€ 560

€ 500

020556 Cromo

019499 Cromo

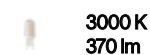
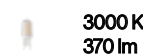

209043 € 3,90

209043 € 3,90





Dubai

Montatura in metallo con finitura cromo o ottone. Elementi decorativi con perle, ottagoni e prismi in cristallo molato trasparente.



243597



243528



P. 341



P. 433

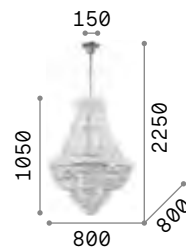

IP20

20,000 Kg / 0,7875 m³
E14 max 24 x 40W

€ 1650

243597 Cromo
243528 Ottone

3000 K
470 lm

101224 € 3,00

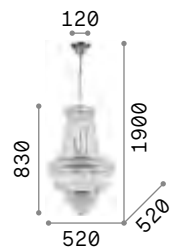

IP20

9,170 Kg / 0,2859 m³
E14 max 10 x 40W

€ 1050

215969 Cromo
207216 Ottone

3000 K
470 lm

101224 € 3,00



Caesar

Montatura in metallo con finitura in oro o cromo. Elementi decorativi in cristallo molato ottagonali con finali a puntale.

LED Lampadine LED G9 3W 3000 K incluse.
Cod. **209043**



114279



114743



P. 341

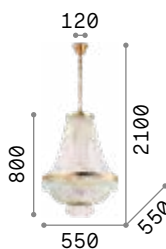

9,600 Kg / 0,2965 m³
G9 max 12 x 40W

€ 1230

114279 ■ Cromo
114743 ■ Oro

3000 K
370 lm

209043 € 3,90

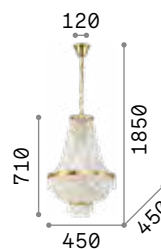

6,700 Kg / 0,1936 m³
G9 max 9 x 40W

€ 950

041827 ■ Cromo
114736 ■ Oro

3000 K
370 lm

209043 € 3,90

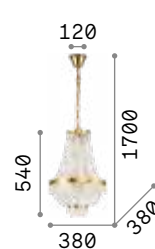

5,100 Kg / 0,1175 m³
G9 max 6 x 40W

€ 780

033532 ■ Cromo
114729 ■ Oro

3000 K
370 lm

209043 € 3,90



Millennium

Montatura e dettagli in metallo verniciato con effetto ruggine. Elementi decorativi centrali in legno naturale antichizzato.

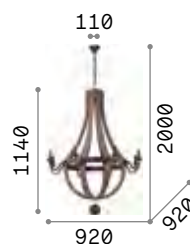

IP20

8,330 Kg / 1,0291 m³
E14 max 8 x 40W

€ 1200

129709 ■ Legno

3000 K
470 lm

101224 € 3,00

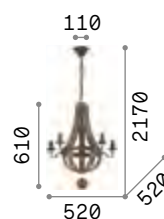

IP20

2,670 Kg / 0,2695 m³
E14 max 5 x 40W

€ 435

129921 ■ Legno

3000 K
470 lm

101224 € 3,00



Monet

Montatura in metallo con fasce circolari decorate a sbalzo. Catene con perle in legno naturale. Finitura con vernice opaca bianca.

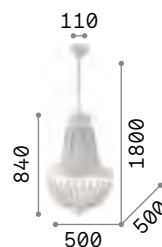

IP20

6,700 Kg / 0,0534 m³
E14 max 6 x 40W

€ 520

162751 Bianco

3000 K
420 lm

101217 € 3,00

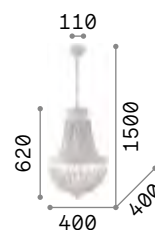

IP20

5,300 Kg / 0,0387 m³
E14 max 5 x 40W

€ 415

162737 Bianco

3000 K
420 lm

101217 € 3,00



Pegaso

Montatura in metallo cromato oppure ottone satinato. Corpo centrale, bobeches e pendagli in cristallo molato. Paralumi in organza. Copricatena in velluto.



059242



197739

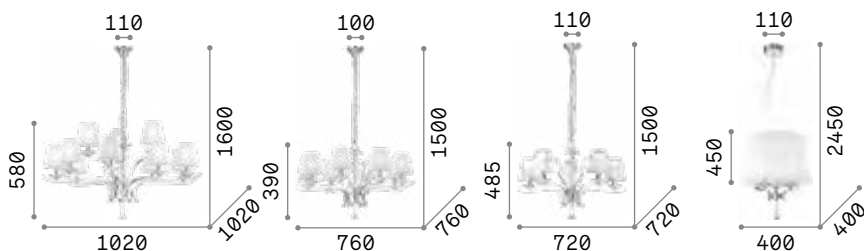

8,100 Kg / 0,3349 m³
E14 max 12 x 40W

€ 840

066431 ■ Bianco
197746 ■ Ottone

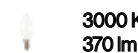

101231 € 3,00



7,900 Kg / 0,2138 m³
E14 max 8 x 40W

€ 490

059242 ■ Bianco
197739 ■ Ottone

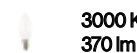

101231 € 3,00



5,600 Kg / 0,1445 m³
E14 max 5 x 40W

€ 460

066448 ■ Bianco
197722 ■ Ottone

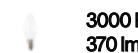

101231 € 3,00



3,050 Kg / 0,0758 m³
E14 max 3 x 40W

€ 230

059235 ■ Bianco
197715 ■ Ottone

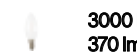

101231 € 3,00



P. 435 P. 487 P. 530



Blanche

Montatura in metallo rifinito con smalto satinato bianco o nero. Paralumi in lamina di PVC rivestita di tessuto bianco o nero. Copricatena in velluto.

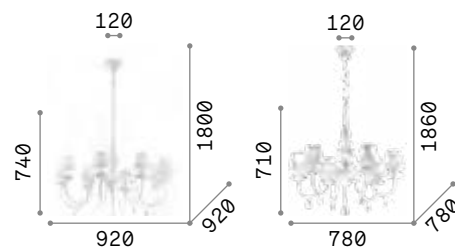

IP20

6,820 Kg / 0,1975 m³
E14 max 8 x 40W

€ 560

035574 ■ Bianco
111896 ■ Nero

3000 K
370 lm

101231 € 3,00

IP20

4,800 Kg / 0,1451 m³
E14 max 6 x 40W

€ 450

035581 ■ Bianco
111872 ■ Nero

3000 K
370 lm

101231 € 3,00



035581



111872



Provence

Corpo luce in legno tornito e bracci in metallo. Finitura con vernice opaca. Paralumi in lamina di PVC rivestita in tessuto a trama grossa.

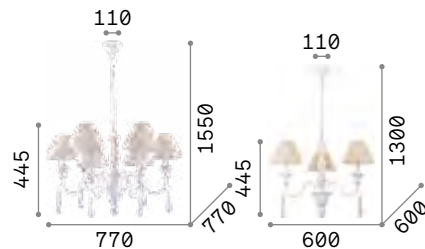

IP20

IP20

3,100 Kg / 0,0700 m³
E14 max 6 x 40W

2,000 Kg / 0,0420 m³
E14 max 3 x 40W

€ 400

€ 250

003399 Bianco

025032 Bianco

3000 K
470 lm

3000 K
470 lm

101224 € 3,00

101224 € 3,00



Colossal

Montatura e dettagli in metallo cromato. Bracci in vetro soffiato trasparente o con interno di colore grigio o bianco avorio. Pendagli ed elementi decorativi in vetro trasparente e cristallo molato. Copricatena in velluto.

IP20	IP20	IP20
19,000 Kg / 0,2828 m³ E14 max 15 x 40W	11,400 Kg / 0,1386 m³ E14 max 8 x 40W	9,200 Kg / 0,1095 m³ E14 max 6 x 40W
€ 1000	€ 800	€ 635
114170 Trasparen. 081564 Avorio 081526 Grigio	114187 Trasparen. 081557 Avorio 081519 Grigio	114194 Trasparen. 081540 Avorio 081502 Grigio
3000 K 470 lm	3000 K 470 lm	3000 K 470 lm
101224 € 3,00	101224 € 3,00	101224 € 3,00

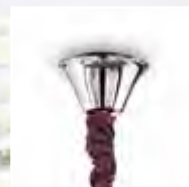

Rose

Lampadario in vetro soffiato con dettagli in metallo cromato. Ottagoni e gocce in cristallo molato. Copricatena in velluto.

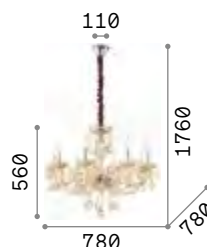

IP20

7,630 Kg / 0,1321 m³
E14 max 8 x 40W

€ 560

166889 ■ Ambra

3000 K
430 lm

101248 € 3,00

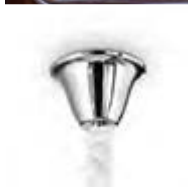

Negresco

Montatura in metallo con finitura in cromo o dorata. Bracci in vetro soffiato trasparente con interno dorato nella versione oro. Centrale composto da blocchi di cristallo molato. Elementi decorativi in vetro trasparente e cristallo molato. Copricatena in velluto.



141060



087771

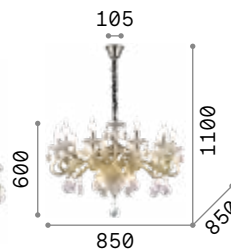

IP20

14,400 Kg / 0,1687 m³
E14 max 10 x 40W

€ 1000

141060 Trasparen.
087771 Oro

3000 K
430 lm

101248 € 3,00

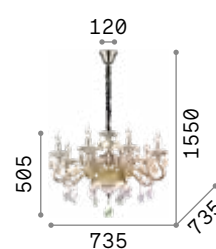

IP20

11,300 Kg / 0,1461 m³
E14 max 8 x 40W

€ 850

141053 Trasparen.
087764 Oro

3000 K
430 lm

101248 € 3,00



P. 436



Tiepolo

Lampadario in vetro soffiato lavorato a mano con dettagli in metallo cromato. Pendagli con ottagoni e gocce in cristallo molato. Copricatena in velluto.

IP20	IP20	IP20
7,220 Kg / 0,1080 m³ E14 max 8 x 40W	5,120 Kg / 0,0791 m³ E14 max 5 x 40W	3,650 Kg / 0,0609 m³ E14 max 3 x 40W
€ 600	€ 500	€ 330
034720 Trasparen.	034713 Trasparen.	034706 Trasparen.
3000 K 370 lm	3000 K 370 lm	3000 K 370 lm
101231 € 3,00	101231 € 3,00	101231 € 3,00



Amadeus

Montatura in metallo cromato.
Elementi decorativi in vetro soffiato
e cristallo molato. Copricatena in
velluto.

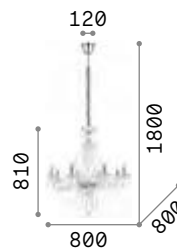

IP20

8,200 Kg / 0,1574 m³
E14 max 8 x 40W

€ 568

168777 Trasparen.

3000 K
470 lm
101224 € 3,00

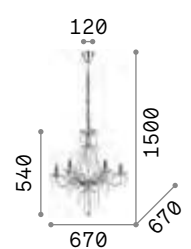

IP20

6,700 Kg / 0,1202 m³
E14 max 6 x 40W

€ 480

168753 Trasparen.

3000 K
470 lm
101224 € 3,00



Giudecca

Lampadario in vetro soffiato lavorato a mano con dettagli in metallo cromato. Pendagli con ottagoni e gocce in cristallo molato. Copricatena in velluto. Disponibile nelle finiture trasparente, nero e rosso.



027821



032504



027418

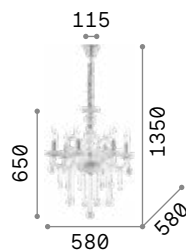

IP20

5,770 Kg / 0,1041 m³
E14 max 6 x 40W

€ 460

027821 Trasparen.
032504 Nero
027418 Rosso

3000 K
430 lm

101248 € 3,00

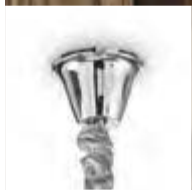

Florian

Montatura in metallo con elementi decorativi in vetro. Pendagli con ottagoni e gocce finali in cristallo molato. Disponibile nelle versioni con vetro trasparente e metallo dorato o cromato.



035604



035611

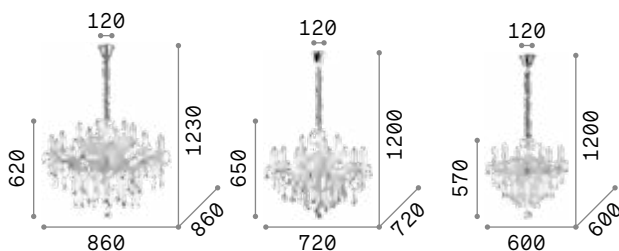

IP20

17,200 Kg / 0,3482 m³
E14 max 18 x 40W

€ 1000

075150 Cromo
075181 Oro

3000 K
470 lm

101224 € 3,00

IP20

9,760 Kg / 0,2187 m³
E14 max 12 x 40W

€ 650

035604 Cromo
035611 Oro

3000 K
470 lm

101224 € 3,00

IP20

6,380 Kg / 0,1368 m³
E14 max 6 x 40W

€ 510

035628 Cromo
035635 Oro

3000 K
470 lm

101224 € 3,00



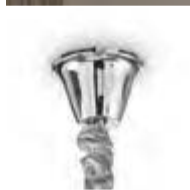

Napoleon

Montatura in metallo cromato o dorato. Elementi decorativi in vetro soffiato e cristallo molato. Copricatena in velluto.



167244



167398

IP20	IP20	IP20
17,920 Kg / 0,4424 m³ E14 max 18 x 40W	11,260 Kg / 0,2633 m³ E14 max 12 x 40W	9,070 Kg / 0,2156 m³ E14 max 8 x 40W
€ 1000	€ 635	€ 600
167268 Cromo 167411 Oro	167251 Cromo 167404 Oro	167244 Cromo 167398 Oro
3000 K 470 lm	3000 K 470 lm	3000 K 470 lm
101224 € 3,00	101224 € 3,00	101224 € 3,00



Gioconda

Corpo luce in fusione di metallo con finitura oro o argento antico. Pendagli ottagonali e tondi in cristallo molato. Copricatena in velluto.

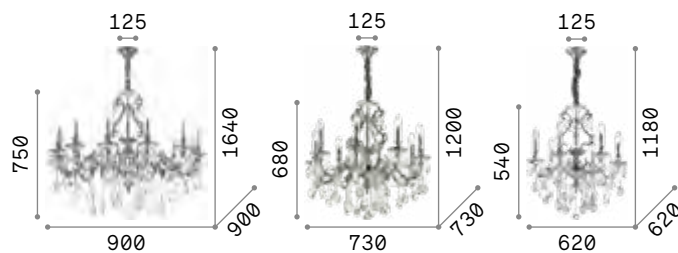

IP20

18,100 Kg / 0,1360 m³
E14 max 12 x 40W

€ 1400

164953 Argento
164960 Oro

3000 K
470 lm

101224 € 3,00

IP20

9,060 Kg / 0,0809 m³
E14 max 8 x 40W

€ 950

044934 Argento
060514 Oro

3000 K
470 lm

101224 € 3,00

IP20

6,340 Kg / 0,0682 m³
E14 max 6 x 40W

€ 725

044927 Argento
060507 Oro

3000 K
470 lm

101224 € 3,00



164953



164960



P. 437

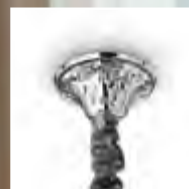

Impero

Corpo luce in fusione di metallo con finitura argento antico. Elementi decorativi in cristallo molato. Copricatena in velluto.

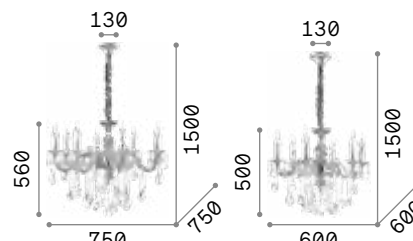

IP20

7,500 Kg / 0,0454 m³
E14 max 8 x 40W

€ 850

014395 ■ Argento

3000 K
470 lm

101224 € 3,00

IP20

5,000 Kg / 0,0340 m³
E14 max 6 x 40W

€ 550

002408 ■ Argento

3000 K
470 lm

101224 € 3,00

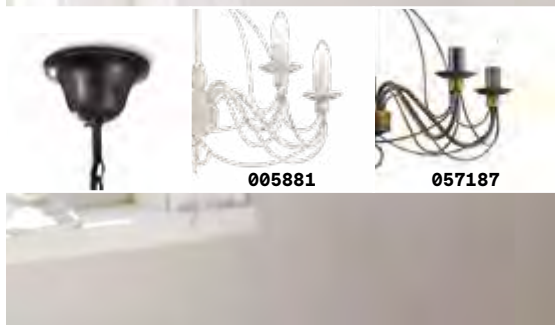

005881

057187

Corte

Montatura completamente in metallo modellato con lavorazione artigianale. Finitura dipinta a mano con effetto antichizzato. Disponibile nella versione bianca o ruggine.

IP20	IP20	IP20
7,100 Kg / 0,6840 m³ E14 max 12 x 40W	5,220 Kg / 0,3169 m³ E14 max 8 x 40W	3,180 Kg / 0,1500 m³ E14 max 5 x 40W
€ 380	€ 260	€ 175
097664 ■ Bianco 097671 ■ Ruggine	005898 ■ Bianco 057194 ■ Ruggine	005881 ■ Bianco 057187 ■ Ruggine
3000 K 470 lm	3000 K 470 lm	3000 K 470 lm
101224 € 3,00	101224 € 3,00	101224 € 3,00





Sem

Montatura completamente in metallo modellato con lavorazione artigianale. Rifinito con vernice satinata bianca.

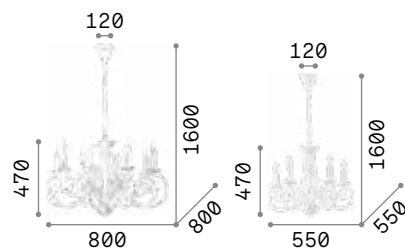

IP20

4,300 Kg / 0,1593 m³
E14 max 8 x 40W

€ 500

092782 Bianco

3000 K
470 lm

101224 € 3,00

IP20

2,200 Kg / 0,0773 m³
E14 max 5 x 40W

€ 320

092751 Bianco

3000 K
470 lm

101224 € 3,00



Strauss

Montatura e dettagli in metallo con finitura oro. Bracci in vetro soffiato trasparente. Elementi decorativi in cristallo ambrato. Copricatena in velluto.

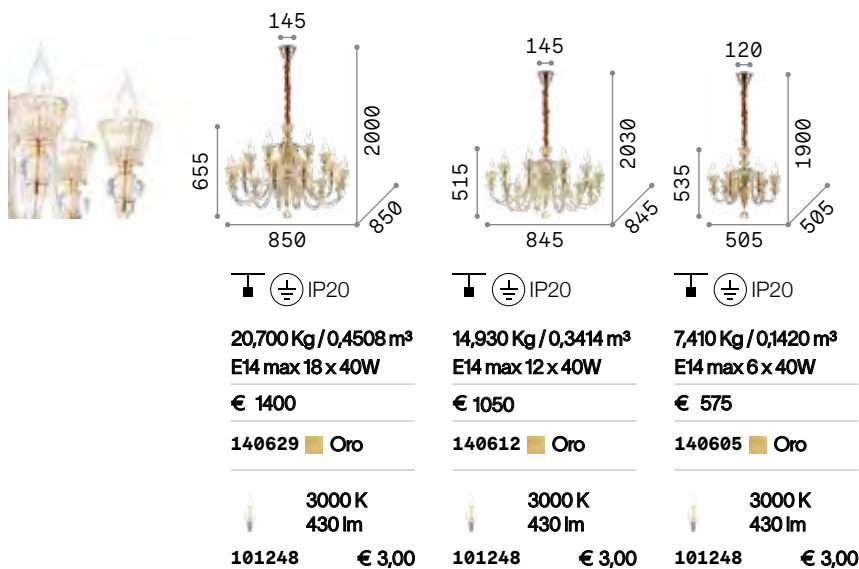



Rialto

Lampadario in vetro trasparente soffiato e lavorato a mano, rifinito con ambra in pasta di vetro. La coppa interna è in metallo ottonato.

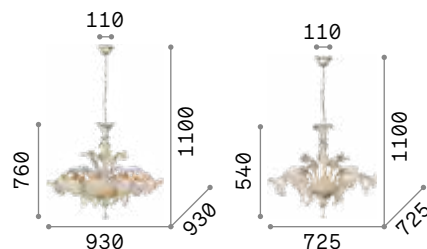

IP20

9,900 Kg / 0,1821 m³
E14 max 8 x 40W

€ 1350

004099 ■ Ambra

3000 K
480 lm

101200 € 3,00

IP20

6,970 Kg / 0,1485 m³
E14 max 5 x 40W

€ 1100

009704 ■ Ambra

3000 K
480 lm

101200 € 3,00



Casanova

Lampadario in vetro soffiato e lavorato a mano con copri portalampade e dettagli in metallo cromato. Disponibile trasparente, bianco o fumè.

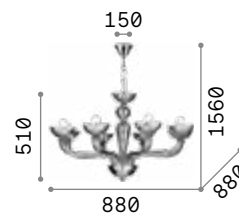

IP20

9,210 Kg / 0,1592 m³
E14 max 8 x 40W

€ 750

044255 ■ Trasparen.
094045 ■ Bianco
095615 ■ Fumè



044255



094045



095615

3000 K
480 lm

101200 € 3,00



Doge

Lampadario in vetro, trasparente o bianco, soffiato e lavorato a mano. Montatura e dettagli in metallo rifinito in cromo.



044422

113678

600 910 1650 570	120 750 1550 750 570	120 750 1500 750 570
IP20	IP20	IP20
9,400 Kg / 0,3064 m ³ E14 max 12 x 40W	6,660 Kg / 0,2229 m ³ E14 max 9 x 40W	5,240 Kg / 0,1602 m ³ E14 max 6 x 40W
€ 690	€ 580	€ 490
168906 Trasparen.	044453 Trasparen.	044422 Trasparen. 113678 Bianco
3000 K 470 lm	3000 K 470 lm	3000 K 470 lm
101224 € 3,00	101224 € 3,00	101224 € 3,00



Danieli

Montatura in metallo cromato o dorato. Elementi decorativi in vetro soffiato trasparente o ambrato. Copricatena in velluto.

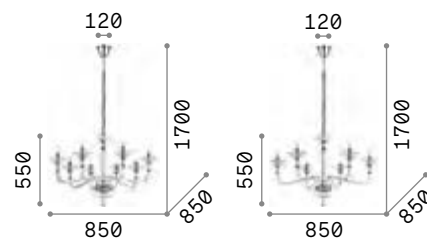

IP20

7,510 Kg / 0,2048 m³
E14 max 8 x 40W

€ 650

159980 Trasparen.
159973 Ambra

3000 K
480 lm

101200 € 3,00

IP20

3,840 Kg / 0,1759 m³
E14 max 6 x 40W

€ 600

159959 Trasparen.
159942 Ambra

3000 K
480 lm

101200 € 3,00



159980



159973



Brigitta

Lampadario in vetro soffiato trasparente o ambrato, lavorato artigianalmente con montatura in metallo e copricatena in velluto.



199382



199412

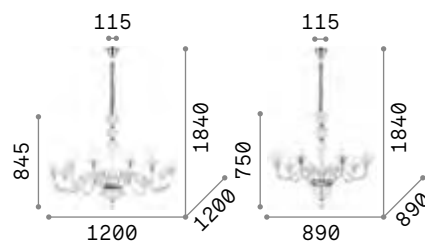

IP20

12,500 Kg / 0,2380 m³
E14 max 12 x 40W

€ 1000

199375 Trasparen.
199405 Ambra

3000 K
480 lm

101200 € 3,00

IP20

7,700 Kg / 0,1797 m³
E14 max 8 x 40W

€ 750

199382 Trasparen.
199412 Ambra

3000 K
480 lm

101200 € 3,00

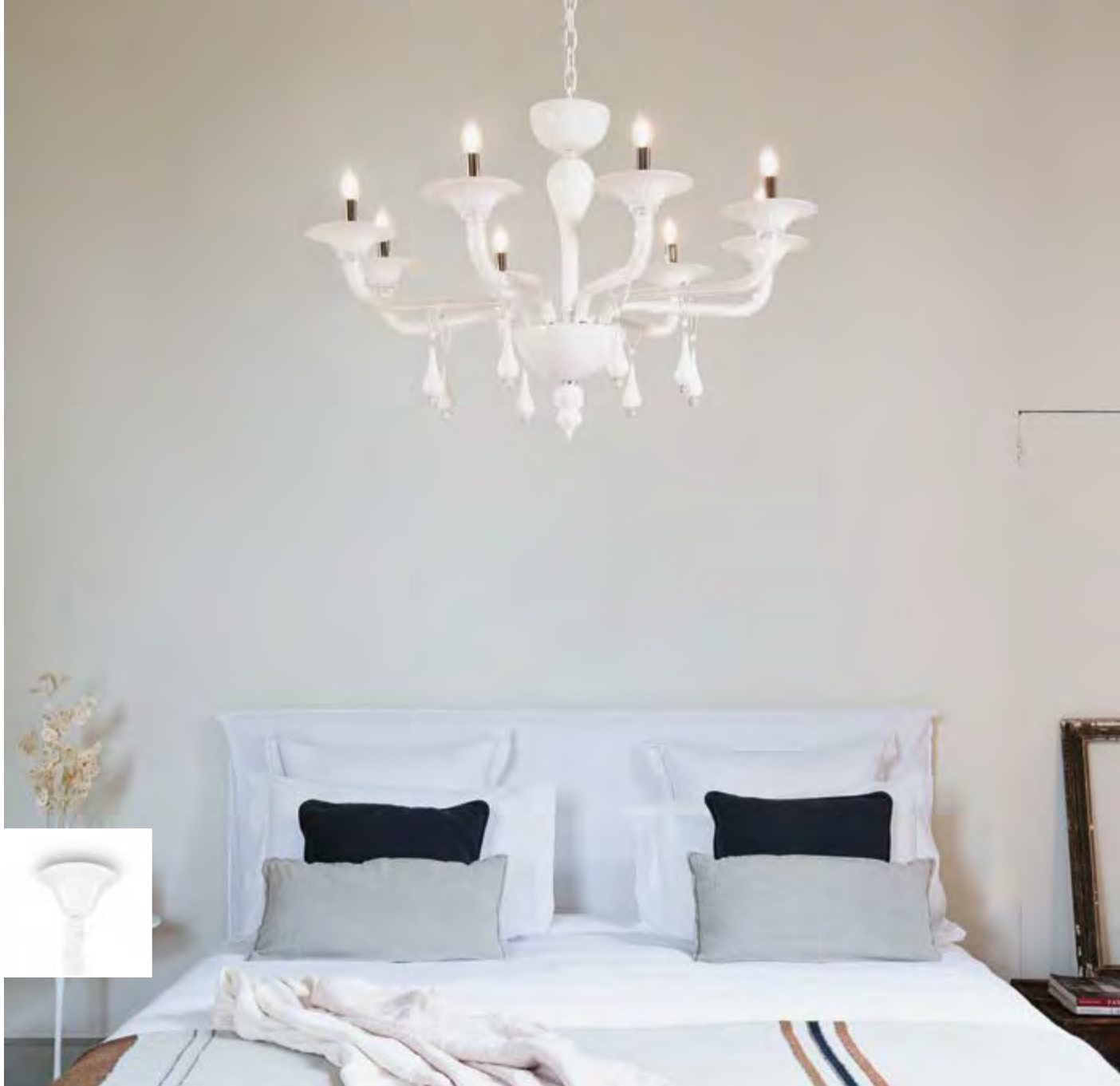

Miramare

Lampadario in vetro trasparente e bianco soffiato e lavorato a mano. Copri portalampade e dettagli in metallo cromato. Copricatena in velluto.

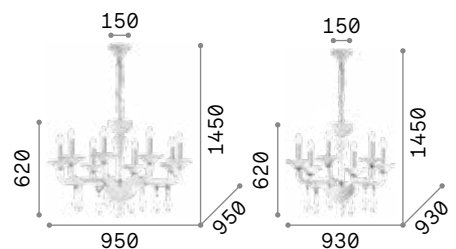

IP20

8,800 Kg / 0,1653 m³
E14 max 8 x 40W

€ 580

068190 Bianco

3000 K
470 lm

101224 € 3,00

IP20

8,100 Kg / 0,1437 m³
E14 max 6 x 40W

€ 500

068183 Bianco

3000 K
470 lm

101224 € 3,00



Bon Bon

Montatura con bracci in fusione di metallo rifinito con vernice opaca bianca o nera. Bobeche in vetro soffiato nella versione bianca, in metallo in quella nera. Copricatena in velluto.

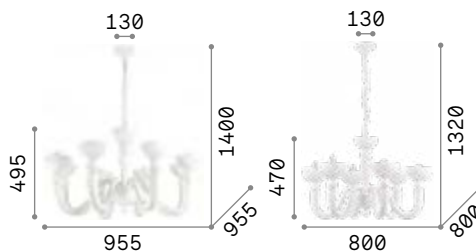

IP20

IP20

11,710 Kg / 0,1953 m³
E14 max 8 x 28W

8,110 Kg / 0,1547 m³
E14 max 6 x 28W

€ 900

€ 630

094007 ■ Bianco

093994 ■ Bianco
140339 ■ Nero

3000 K
420 lm

3000 K
420 lm

101217 € 3,00

101217 € 3,00



093994



140339



Firenze

Corpo luce in resina. Bracci e foglie in metallo modellato artigianalmente. Decorato a mano con foglia d'oro e antichizzato.

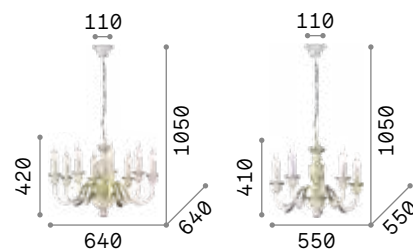

IP20

6,440 Kg / 0,0842 m³
E14 max 8 x 40W

€ 510

012872 Bianco
020839 Oro

3000 K
430 lm

101248 € 3,00

IP20

4,360 Kg / 0,0609 m³
E14 max 5 x 40W

€ 400

012865 Bianco
020822 Oro

3000 K
430 lm

101248 € 3,00



012872



020839



P. 438



P. 481



P. 531



Justine

Rosone e montatura in metallo con bracci in fusione. Rifinito con vernice opaca bianca. Copricatena in velluto.

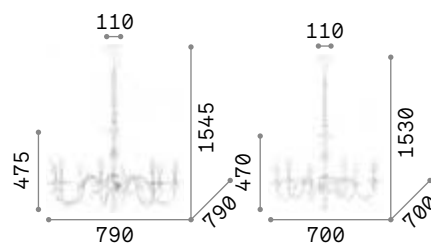

IP20

4,550 Kg / 0,3281 m³
E14 max 8 x 40W

€ 495

197524 Bianco

3000 K
430 lm

101248 € 3,00

IP20

3,440 Kg / 0,2592 m³
E14 max 6 x 40W

€ 390

197500 Bianco

3000 K
430 lm

101248 € 3,00



Vanity

Montatura in metallo dorato con dettagli nero opaco. Elementi decorativi in cristallo molato. Copricatena in velluto.

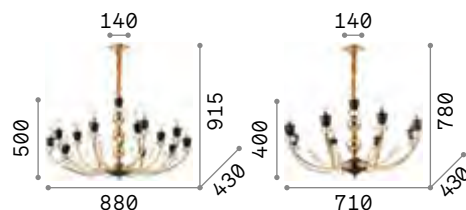

IP20

8,850 Kg / 0,2878 m³
E14 max 15 x 40W

€ 680

206639 Oro

3000 K
470 lm

101224 € 3,00

IP20

4,940 Kg / 0,1454 m³
E14 max 8 x 40W

€ 420

206622 Oro

3000 K
470 lm

101224 € 3,00



Harem

Montatura con decori in rilievo in metallo brunito e ottagononi in cristallo molato incastonati. Diffusori in vetro soffiato trasparente leggermente ambrato con pendaglio a nappa. Copricatena in velluto.

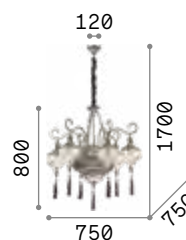

IP20

8,550 Kg / 0,2571 m³
E27 max 9x42W

€ 1150

116006 ■ Brunito

3000 K
910 lm

119571 € 7,00

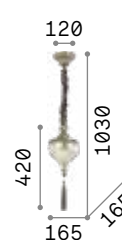

IP20

0,980 Kg / 0,0228 m³
E27 max 1x42W

€ 170

115979 ■ Brunito

3000 K
910 lm

119571 € 7,00



P. 440



Chalet

Montatura con struttura portante in metallo. Elementi decorativi in resina lavorata artigianalmente e dipinta a mano come fedele riproduzione di corna e legno intagliato.

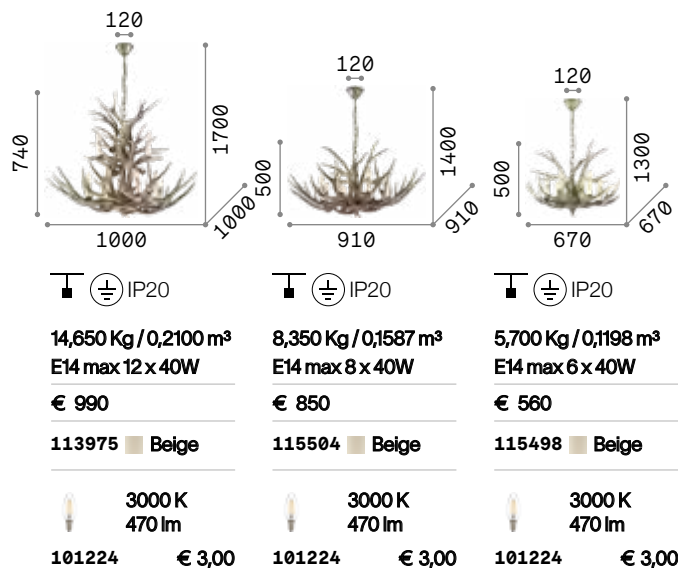

P. 438 P. 480

Haunt

Rosone in metallo verniciato bianco opaco. Cavo in tessuto. Diffusore con cesto in vimini al naturale o verniciato in bianco.



IP20

0,460 Kg / 0,0622 m³

E27 max 1x60W

€ 180

159256 Bianco

159812 Legno

3000 K
1020 lm

101347 € 8,50



Driftwood

Rosone in metallo. Struttura sospesa di rami naturali. Copri portalampade in metallo spazzolato.

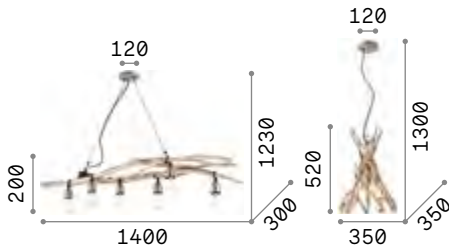

IP20

IP20

4,500 Kg / 0,1402 m³

E27 max 6x60W

€ 430

180922 Legno

1,240 Kg / 0,0599 m³

E27 max 1x60W

€ 315

129600 Legno

2200 K
370 lm

151687 € 5,50

2200 K
370 lm

151687 € 5,50



P. 478



P. 518





Canapa

Montatura in metallo verniciato.
Cavi elettrici e diffusori rivestiti in
corda di canapa naturale.

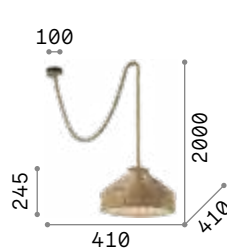

IP20

2,190 Kg / 0,0944 m³
E27 max 1x15W

€ 180

134833 ■ Corda

3000 K
910 lm
119571 € 7,00



IP20

0,650 Kg / 0,0063 m³
E27 max 2x15W

€ 60

134840 ■ Corda

3000 K
910 lm
119571 € 7,00

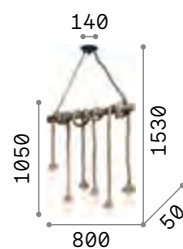

IP20

2,410 Kg / 0,0254 m³
E27 max 6x15W

€ 180

134826 ■ Corda

3000 K
910 lm
119571 € 6,50



Electric

Montatura in metallo rifinito corten. Cavo in tessuto. Portalampade in ceramica smaltata. Cavi in acciaio a lunghezza regolabile.

3,000 Kg / 0,0162 m³	1,800 Kg / 0,0093 m³
E27 max 8 x 60W	E27 max 4 x 60W
€ 295	€ 205
176369	176352
2200 K 370 lm	2200 K 370 lm
151687 € 5,50	151687 € 5,50

Norma

Montatura in metallo con finitura in cromo o in brunito. Diffusore composto da lastre di vetro trasparente con bordo molato. Copricatena in velluto.

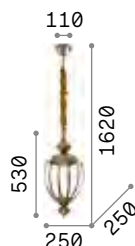

2,620 Kg / 0,0286 m³

E27 max 1x60W

€ 210

094786 Cromo

005911 Brunito

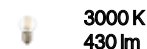

101279 € 3,00



Deca

Montatura in metallo con finitura in brunito. Diffusore in lastre di vetro trasparente, apribile per sostituzione lampadina.

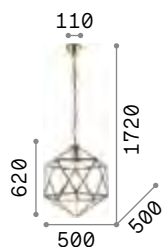

6,720 Kg / 0,2288 m³

E27 max 1x60W

€ 440

168869 Brunito

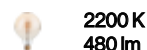

151724 € 8,50

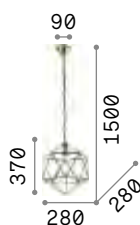

2,580 Kg / 0,0589 m³

E27 max 1x60W

€ 225

168852 Brunito

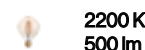

151717 € 8,90



Orangerie

Montatura in metallo rifinito brunito. Diffusore in lastre di vetro trasparente. Cavo in tessuto nero.

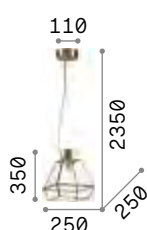
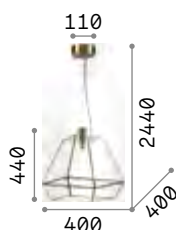

5,000 Kg / 0,1221 m³
E27 max 1x60W

2,200 Kg / 0,0414 m³
E27 max 1x60W

€ 375

€ 265

160085 ■ Brunito

152776 ■ Brunito

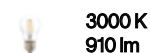
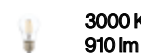

119571 € 7,00

119571 € 7,00



Rondo

Montatura in metallo con finitura in brunito. Diffusore in lastre di vetro trasparente. Cavo in acciaio regolabile in lunghezza.

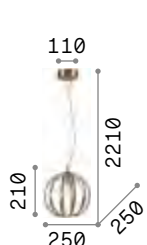
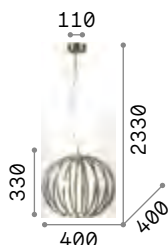

3,910 Kg / 0,1237 m³
E27 max 1x60W

1,970 Kg / 0,0403 m³
E27 max 1x60W

€ 410

€ 240

168968 ■ Brunito

168951 ■ Brunito

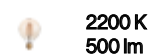

151724 € 8,50

151717 € 8,90





Interni

Lampade da soffitto

Indice alfabetico

Admiral	335	Karol	258	Play	307
Alfa	314	King	334	Rain	339
Almond	330	Konig	312	Relax	278
Angolo	326	Lana	294	Ritz	293
Arizona	284	Level	282	Roma	332
Aura	297	Lika	305	Royal	338
Bijoux	338	Lingotto	327	Rudy	311
Birds	319	Look	298	Set Up	290
Caesar	341	Magnolia	340	Shell	295
Candy	285	Mapa Bianco	284	Simply	294
Carlton	343	Maracas	315	Sky	299
Celine	277	Martinez	342	Slem	314
Clara	276	Mix Up	288	Smarties	283
Cloud	286	Mood	301	Spark	324
Compo	331	Moonlight	337	Spike	303
Cosmopolitan	325	Mouse	310	Spot	310
Daisy	330	Multiflex	322	Toby	307
Dea	320	Neve	336	Totem	279
Dot	302	Ninfea	329	Tower	304
Dubai	341	Nitro	300	Triumph	318
Dynamite	306	Nodi	316	Universal R.	272
Flat	276	Nodino	317	Universal S.	274
Fly	260	Oak	304	Wheel	293
Frame	256	Oby	311	Winery	309
Geko	281	Ocean	277	Woody	292
Gemma	296	Octopus	323	Ziggy	287
Gingle	280	Oracle Slim	254		
Glim	313	Ovalino	286		
Glory	282	Oz	259		
Gourmet	324	Pashà	333		
Halo	270	Pauline	321		
Hermes	328	Petit	308		















































Konig

Pag 312













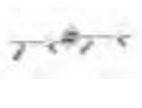























Interni

Indice icone

			 new	 new		
OracleSlim 254	Frame 256	Karol 258	Oz 259	Fly 260	Halo 270	Universal R. 272
	 new					
Universal S. 274	Clara 276	Flat 276	Celine 277	Ocean 277	Relax 278	Totem 279
						
Gingle 280	Geko 281	Glory 282	Level 282	Smarties 283	Arizona 284	MapaBianco 284
			 new	 new	 new	
Candy 285	Ovalino 286	Cloud 286	Ziggy 287	Mix Up 288	Set Up 290	Woody 292
						 new
Wheel 293	Ritz 293	Simply 294	Lana 294	Shell 295	Gemma 296	Aura 297
				 new		
Look 298	Sky 299	Nitro 300	Mood 301	Dot 302	Spike 303	Oak 304
						
Tower 304	Lika 305	Dynamite 306	Play 307	Toby 307	Petit 308	Winery 309
				 new		
Mouse 310	Spot 310	Rudy 311	Oby 311	Konig 312	Glim 313	Alfa 314

Interni

Indice icone

						
Slem 314	Maracas 315	Nodi 316	Nodino 317	Triumph 318	Birds 319	Dea 320
						
Pauline 321	Multiflex 322	Octopus 323	Spark 324	Gourmet 324	Cosmopolitan 325	Angolo 326
						
Lingotto 327	Hermes 328	Ninfea 329	Almond 330	Daisy 330	Compo 331	Roma 332
						
Pashà 333	King 334	Admiral 335	Neve 336	Moonlight 337	Royal 338	Bijoux 338
						
Rain 339	Magnolia 340	Dubai 341	Caesar 341	Martinez 342	Carlton 343	

Hermes

Pag 328





Oracle Slim

Lampada da soffitto costituita da una montatura sottile in alluminio verniciato bianco o nero opaco e diffusore opale in policarbonato. Disponibile nel modello circolare in tre dimensioni diverse. LED integrati, disponibile in temperatura di colore 3000 K, CRI ≥ 80, durata utile LED 17.500 h, protezione IP20, classe isolamento II.

LED Sorgente luminosa LED 3000 K, 20.000 h di durata.

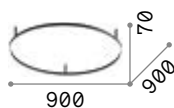
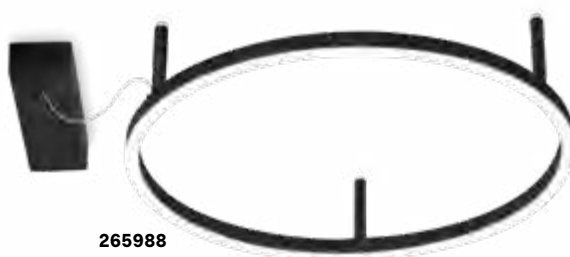
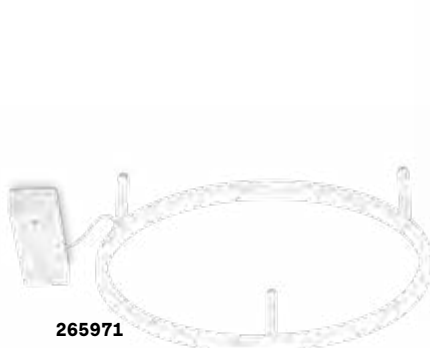

1,700 Kg / 0,1345 m³
LED 55W / 5300 lm

€ 295

266015 ■ Bianco
266022 ■ Nero

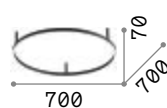

1,430 Kg / 0,0852 m³
LED 38W / 4300 lm

€ 240

265995 ■ Bianco
266008 ■ Nero

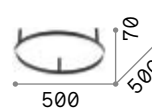

1,240 Kg / 0,0455 m³
LED 32W / 3150 lm

€ 195

265971 ■ Bianco
265988 ■ Nero



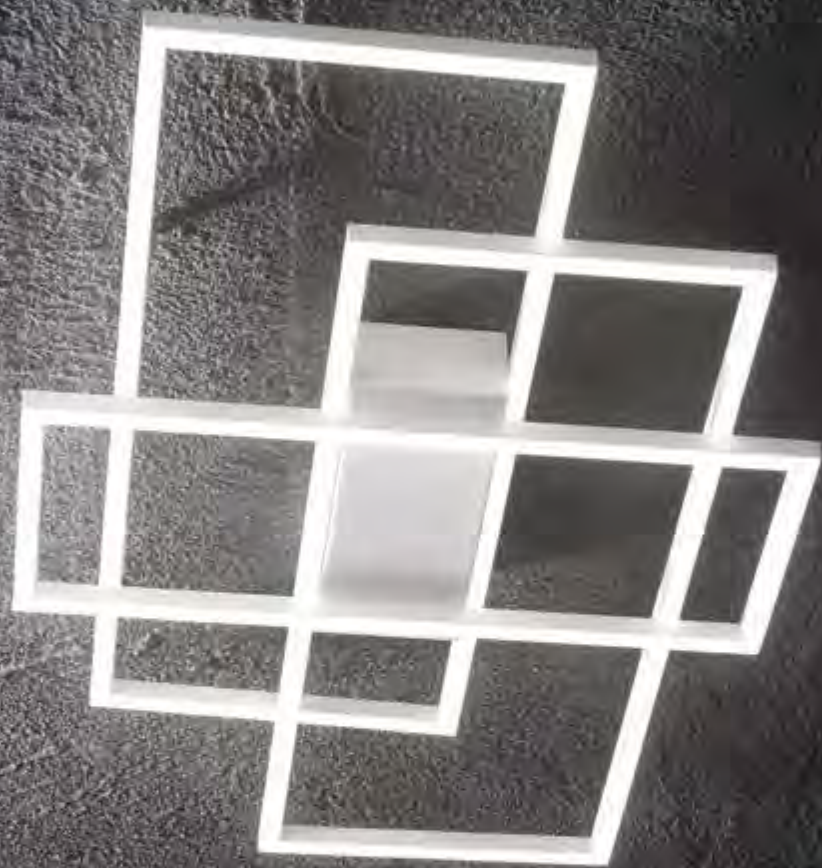

Frame

Base e montatura in metallo verniciato bianco opaco o nero opaco. Diffusori in materiale plastico colore opale. Emissione luce diretta.

LED Sorgente luminosa LED 3000 K, 30.000 h di durata.

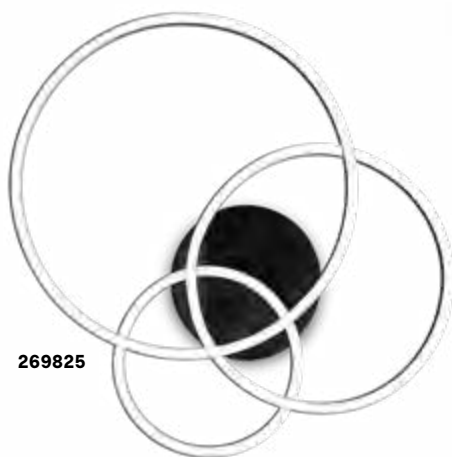

269825

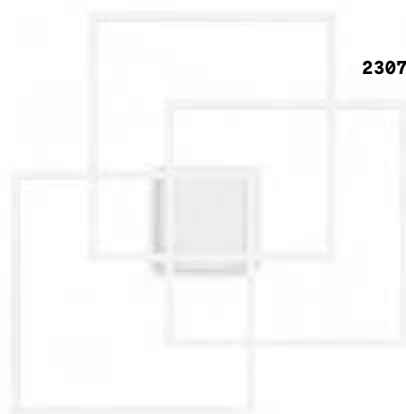

230702

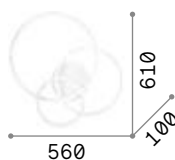

■ ■ □ IP20

1,600 Kg / 0,0458 m³
LED 41W / 5250 lm

€ 320

255019 ■ Bianco
269825 ■ Nero

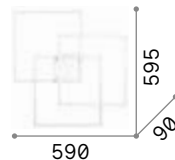

■ ■ □ IP20

1,430 Kg / 0,0530 m³
LED 35W / 4950 lm

€ 320

230702 ■ Bianco
270678 ■ Nero

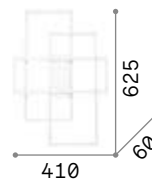

■ ■ □ IP20

1,240 Kg / 0,0264 m³
LED 31W / 4250 lm

€ 290

230726 ■ Bianco
270661 ■ Nero





Karol

Corpo luce in metallo verniciato bianco opaco. Diffusore in materiale plastico colore opale.



Sorgente luminosa LED 4000 K, 50.000 h di durata.



3,430 Kg / 0,185 m³
LED 90W / 12200 lm

€ 515

227832 Bianco

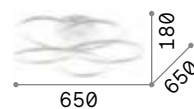

2,300 Kg / 0,0901 m³
LED 78W / 10700 lm

€ 375

227825 Bianco



Oz **new**

Base e montatura in metallo verniciato a polveri o placcato. Diffusore in gomma opale. Disponibile nelle finiture bianco, nero o ottone spazzolato. Disponibile anche in versione dimmerabile DALI/Push.

LED Sorgente luminosa LED 3000 K, 30.000 h di durata.

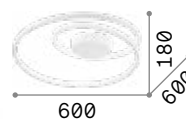

IP20

2,010 Kg / 0,0676 m³
LED 48W / 5200 lm

€ 320 On-Off / 395 Dalì

253688	Bianco	On-Off
304519	Bianco	Dalì/Push ^{new}
269412	Nero	On-Off
304526	Nero	Dalì/Push ^{new}
269429	Ottone	On-Off
304533	Ottone	Dalì/Push ^{new}



P. 060



P. 350



P. 448

Fly new

Famiglia di lampade a plafone con base circolare, disponibile in quattro diametri diversi (350 mm, 450 mm, 600 mm, 900 mm) oltre che nella variante SLIM dall'altezza più compatta. Corpo luce in alluminio verniciato a polveri in finitura bianco RAL 9016 e nero RAL 9004, ottica arretrata (FLY PL) oppure a filo (FLY SLIM) con diffusore in PMMA microprismatizzato con controllo dell'abbagliamento (UGR < 19). La lampada è predisposta per essere integrata con il modulo accessorio uplight per la componente di illuminazione indiretta. Sorgente luminosa a LED integrati; disponibile in temperatura di colore 3000 K e 4000 K; CRI ≥ 80; durata utile LED 50.000 h; protezione IP40, classe isolamento I. Driver incluso, integrato nel corpo illuminante, disponibile in versione dimmerabile 1-10V, DALI e Push. Sistema adatto per ambienti dove richiama un'illuminazione professionale e uniforme, ad esempio UFFICI e spazi COMMERCIALI. L'elevata resa cromatica lo rende ideale anche per gli spazi espositivi e la valorizzazione della merce in showroom e aree vendita nel settore RETAIL.

PRO

Prodotto ad alto contenuto tecnologico, elevata qualità dei materiali, destinato ad uso professionale.

IP40

Grado di protezione IP40.

Sorgente	LED SMD
Potenza	18W / 26W / 53W / 65W
Driver incluso	On/Off
Driver disponibili	1-10V / DALI / Push
MacAdam	SDCM 3
CCT	3000 K / 4000 K
CRI	≥80
UGR	<19
Durata LED	50.000 h
Classe isolamento	I
IP	40
Materiale	Alluminio
Garanzia	5 anni



P. 070





Fly

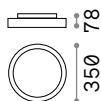

3,000 Kg/0,0160 m³

LED SMD SAMSUNG Driver TRIDONIC ON/OFF incluso

Potenza	Angolo	Lumen	CCT	Finitura	Codice	€
18 W	87°	2650 lm	3000 K	Bianco	270272	315
				Nero	306575	315 <i>new</i>
		2800 lm	4000 K	Bianco	270289	315
				Nero	306582	315 <i>new</i>

DIMMABLE DRIVER Non incluso/Optional

	Potenza	Output	Misura	Codice	€
1-10V/Push	20 W	500 mA	108 x 22 x 52 mm	270333	65
DALI	20 W	500 mA	108 x 22 x 52 mm	270364	85

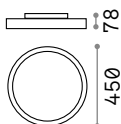

3,700 Kg/0,0250 m³

LED SMD SAMSUNG Driver TRIDONIC ON/OFF incluso

Potenza	Angolo	Lumen	CCT	Finitura	Codice	€
26 W	87°	3700 lm	3000 K	Bianco	254272	420
				Nero	306599	420 <i>new</i>
		3900 lm	4000 K	Bianco	270296	420
				Nero	306605	420 <i>new</i>

DIMMABLE DRIVER Non incluso/Optional

	Potenza	Output	Misura	Codice	€
1-10V/Push	32 W	700 mA	94 x 21 x 67 mm	270586	75
DALI	32 W	700 mA	94 x 21 x 67 mm	270593	95

UPLIGHT Non incluso/Optional



Modello	Potenza	Angolo	Lumen	CCT	Codice	€
ø35	13 W	120°	1600 lm	3000 K	270258	85
			1700 lm	4000 K	270395	85
ø45	13 W	120°	1600 lm	3000 K	270258	85
			1700 lm	4000 K	270395	85



Light beam: WIDE

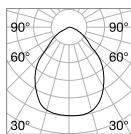

m	lx	Øm
1	2945	1,90
2	736	3,80
3	327	5,60
4	184	7,50
5	116	9,40

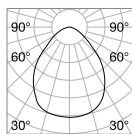
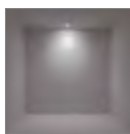

m	lx	Øm
1	1562	1,90
2	390	3,70
3	174	5,60
4	98	7,50
5	62	9,40

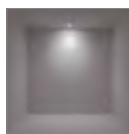

CRI≥80 18W 87° 2650lm 3000K

CRI≥80 26W 87° 3700lm 3000K



Fly

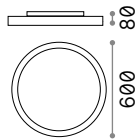

4,500 Kg/0,0423 m³

LED SMD SAMSUNG Driver TRIDONIC ON/OFF incluso

Potenza	Angolo	Lumen	CCT	Finitura	Codice	€
53 W	87°	7500 lm	3000 K	Bianco	270302	610
				Nero	292205	610 <i>new</i>
		8000 lm	4000 K	Bianco	270319	610
				Nero	306612	610 <i>new</i>

DIMMABLE DRIVER Non incluso/Optional

	Potenza	Output	Misura	Codice	€
1-10V	60 W	1400 mA	124 x 23 x 82 mm	270340	112
DALI / Push	60 W	1400 mA	125 x 28 x 85 mm	270371	135

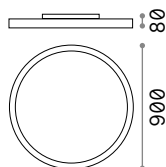

6,900 Kg/0,0903 m³

LED SMD SAMSUNG Driver TRIDONIC ON/OFF incluso

Potenza	Angolo	Lumen	CCT	Finitura	Codice	€
65 W	87°	9400 lm	3000 K	Bianco	270326	1180
				Nero	306629	1180 <i>new</i>
		9000 lm	4000 K	Bianco	270241	1180
				Nero	306636	1180 <i>new</i>

DIMMABLE DRIVER Non incluso/Optional

	Potenza	Output	Misura	Codice	€
1-10V	68 W	1400 mA	130 x 25 x 75 mm	270357	125
DALI / Push	100 W	1400 mA	140 x 30 x 100 mm	270388	180

UPLIGHT Non incluso/Optional



Modello	Potenza	Angolo	Lumen	CCT	Codice	€
ø60	20 W	120°	2650 lm	3000 K	270401	150
			2750 lm	4000 K	270265	150
ø90	28 W	120°	3650 lm	3000 K	271002	225
			3850 lm	4000 K	270715	225



Light beam: WIDE

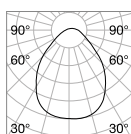

m	lx	Øm
1	2945	1,90
2	736	3,80
3	327	5,60
4	184	7,50
5	116	9,40

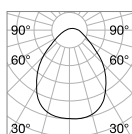
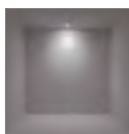

m	lx	Øm
1	3991	1,90
2	998	3,90
3	443	5,80
4	249	7,80
5	160	9,70



CRI≥80 53W 87° 7500lm 3000K

CRI≥80 65W 87° 9400lm 3000K



Fly Slim

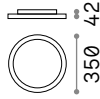

LED SMD SAMSUNG Driver TRIDONIC ON/OFF incluso

Potenza	Angolo	Lumen	CCT	Finitura	Codice	€
18 W	87°	2650 lm	3000 K	Bianco	306643	295 <small>new</small>
		2800 lm	4000 K	Bianco	306650	295 <small>new</small>

2,700 Kg/0,0105 m³

DIMMABLE DRIVER Non incluso/Optional

	Potenza	Output	Misura	Codice	€
1-10V/Push	20 W	500 mA	108 x 22 x 52 mm	270333	65
DALI	20 W	500 mA	108 x 22 x 52 mm	270364	85

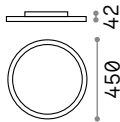

LED SMD SAMSUNG Driver TRIDONIC ON/OFF incluso

Potenza	Angolo	Lumen	CCT	Finitura	Codice	€
26 W	87°	3700 lm	3000 K	Bianco	292236	390 <small>new</small>
		3900 lm	4000 K	Bianco	306667	390 <small>new</small>

3,750 Kg/0,0170 m³

DIMMABLE DRIVER Non incluso/Optional

	Potenza	Output	Misura	Codice	€
1-10V/Push	32 W	700 mA	94 x 21 x 67 mm	270586	75
DALI	32 W	700 mA	94 x 21 x 67 mm	270593	95

UPLIGHT Non incluso/Optional



Modello	Potenza	Angolo	Lumen	CCT	Codice	€
ø35	13 W	120°	1600 lm	3000 K	270258	85
			1700 lm	4000 K	270395	85
ø45	13 W	120°	1600 lm	3000 K	270258	85
			1700 lm	4000 K	270395	85



Light beam: WIDE

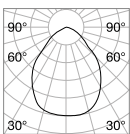

m	lx	Øm
1	1066	1,90
2	267	3,70
3	118	5,60
4	67	7,50
5	43	9,40

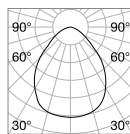
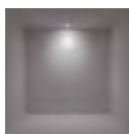

m	lx	Øm
1	1511	1,90
2	378	3,80
3	168	5,70
4	94	7,60
5	60	9,50



CRI≥80 18W 87° 2650lm 3000K

CRI≥80 26W 87° 3700lm 3000K



Fly Slim

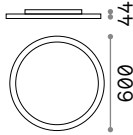

LED SMD SAMSUNG Driver TRIDONIC ON/OFF incluso

Potenza	Angolo	Lumen	CCT	Finitura	Codice	€
53 W	87°	7500 lm	3000 K	Bianco	292250	575 <small>new</small>
		8000 lm	4000 K	Bianco	306674	575 <small>new</small>

5,800 Kg/0,0699 m³

DIMMABLE DRIVER Non incluso/Optional

	Potenza	Output	Misura	Codice	€
1-10V	60 W	1400 mA	124 x 23 x 82 mm	270340	112
DALI / Push	60 W	1400 mA	125 x 28 x 85 mm	270371	135

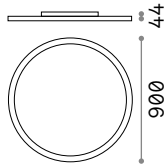

LED SMD SAMSUNG Driver TRIDONIC ON/OFF incluso

Potenza	Angolo	Lumen	CCT	Finitura	Codice	€
65 W	87°	9400 lm	3000 K	Bianco	306681	1125 <small>new</small>
		9900 lm	4000 K	Bianco	306698	1125 <small>new</small>

13,000 Kg/0,1448 m³

DIMMABLE DRIVER Non incluso/Optional

	Potenza	Output	Misura	Codice	€
1-10V	68 W	1400 mA	130 x 25 x 75 mm	270357	125
DALI / Push	100 W	1400 mA	140 x 30 x 100 mm	270388	180

UPLIGHT Non incluso/Optional



Modello	Potenza	Angolo	Lumen	CCT	Codice	€
ø60	20 W	120°	2650 lm	3000 K	270401	150
			2750 lm	4000 K	270265	150
ø90	28 W	120°	3650 lm	3000 K	271002	225
			3850 lm	4000 K	270715	225



Light beam: WIDE

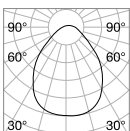

m	lx	Øm
1	3000	1,90
2	750	3,80
3	333	5,70
4	187	7,60
5	120	9,50

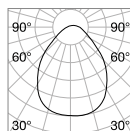
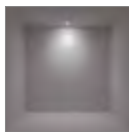

m	lx	Øm
1	3857	1,90
2	964	3,90
3	429	5,80
4	241	7,80
5	154	9,70



CRI≥80 53W 87° 7500lm 3000K

CRI≥80 65W 87° 9400lm 3000K



Halo

Lampada a plafone con base circolare e corpo luce in alluminio verniciato a polveri. Diffusore opale in policarbonato. Disponibile in tre diversi diametri di colore bianco. Sorgente luminosa a LED integrati con binning iniziale ≤ 2-Step MacAdam; disponibile in temperatura di colore 3000 K e 4000 K; CRI ≥ 80; durata utile LED 35.000 h; protezione IP20, classe isolamento I.

Sorgente	LED SMD	Durata LED	35.000 h
Potenza	26W / 32W / 46W	Classe	I
Driver incluso	On/Off	isolamento	
Driver disponibili	No	IP	20
CCT	3000 K / 4000 K	Materiale	Alluminio
CRI	≥80		
UGR	<22		



Luce indiretta inclusa.



LED SMD Driver ON/OFF incluso

Potenza	Angolo	Lumen	CCT	Finitura	Codice	€
26 W	110°	3150 lm	3000 K	Bianco	223186	295
		3450 lm	4000 K	Bianco	223193	295

2,750 Kg/0,0177 m³



LED SMD Driver ON/OFF incluso

Potenza	Angolo	Lumen	CCT	Finitura	Codice	€
32 W	110°	4050 lm	3000 K	Bianco	223209	395
		4200 lm	4000 K	Bianco	223216	395

4,430 Kg/0,0313 m³

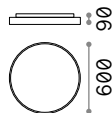

LED SMD Driver ON/OFF incluso

Potenza	Angolo	Lumen	CCT	Finitura	Codice	€
46 W	110°	5950 lm	3000 K	Bianco	223223	545
		6250 lm	4000 K	Bianco	223230	545

6,600 Kg/0,0566 m³



P. 072



Universal Round

Plafoniera diffusiva per installazione a soffitto o parete in interni, adatta per un'illuminazione generale e uniforme. Scocca in acciaio verniciato con finitura bianca, diffusore in materiale plastico. Sorgente luminosa integrata a LED, disponibile in 4 potenze differenti. Durata utile LED 17.500 h; protezione IP20, classe isolamento II.

Sorgente	LED SMD	Classe	II
Potenza	13,5W / 36W	isolamento	
Driver incluso	On/Off	IP	20
Driver disponibili	No	Materiale	Acciaio
CCT	3000 K		
CRI	≥80		
Durata LED	30.000 h		



LED SMD Driver ON/OFF incluso

Potenza	Angolo	Lumen	CCT	Finitura	Codice	€
13,5 W	110°	1250 lm	3000 K	Bianco	138596	30

0,420 Kg/0,0015 m³



LED SMD Driver ON/OFF incluso

Potenza	Angolo	Lumen	CCT	Finitura	Codice	€
19 W	110°	1950 lm	3000 K	Bianco	138602	35

0,580 Kg/0,0025 m³

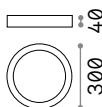

LED SMD Driver ON/OFF incluso

Potenza	Angolo	Lumen	CCT	Finitura	Codice	€
25 W	110°	2600 lm	3000 K	Bianco	138619	50

0,850 Kg/0,0045 m³

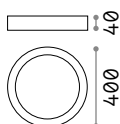

LED SMD Driver ON/OFF incluso

Potenza	Angolo	Lumen	CCT	Finitura	Codice	€
36 W	110°	3900 lm	3000 K	Bianco	240367	85

1,390 Kg/0,0068 m³



Universal Square

Plafoniera diffusiva per installazione a soffitto o parete in interni, adatta per un'illuminazione generale e uniforme. Scocca in acciaio verniciato con finitura bianca, diffusore in materiale plastico. Sorgente luminosa integrata a LED, disponibile in 4 potenze differenti. Durata utile LED 17.500 h; protezione IP20, classe isolamento II.

Sorgente	LED SMD	Classe	II
Potenza	13,5W / 36W	isolamento	
Driver incluso	On/Off	IP	20
Driver disponibili	No	Materiale	Acciaio
CCT	3000 K		
CRI	≥80		
Durata LED	30.000 h		



0,510 Kg/0,0015 m³

LED SMD Driver ON/OFF incluso

Potenza	Angolo	Lumen	CCT	Finitura	Codice	€
13,5 W	110°	1250 lm	3000 K	Bianco	138633	30



0,710 Kg/0,0025 m³

LED SMD Driver ON/OFF incluso

Potenza	Angolo	Lumen	CCT	Finitura	Codice	€
19 W	110°	1950 lm	3000 K	Bianco	138640	35



1,070 Kg/0,0045 m³

LED SMD Driver ON/OFF incluso

Potenza	Angolo	Lumen	CCT	Finitura	Codice	€
25 W	110°	2600 lm	3000 K	Bianco	138657	50



2,000 Kg/0,0068 m³

LED SMD Driver ON/OFF incluso

Potenza	Angolo	Lumen	CCT	Finitura	Codice	€
36 W	110°	3900 lm	3000 K	Bianco	240374	85



Clara new

Base in metallo verniciato.
Diffusore in policarbonato opale satinato.

LED Sorgente luminosa LED 3000/4000 K,
25.000 h di durata.

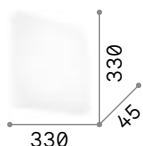
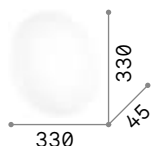

■ ■ □ IP20

0,500 Kg / 0,0082 m³
LED 16W / 1550/1650 lm

€ 30

300436 Bianco 3000K new 300443 Bianco 3000K new
306438 Bianco 4000K new 306445 Bianco 4000K new

■ ■ □ IP20

0,670 Kg / 0,0141 m³
LED 17W / 1950/2050 lm

€ 40



Flat

Montatura in metallo smaltato
bianco opaco. Diffusore in lastra di
acrilico satinato trasparente.

LED Lampadine LED GX53 9W 3000 K
includ. Cod. **123936**

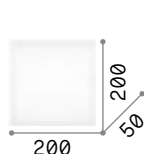
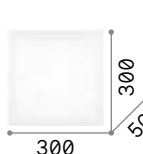
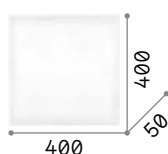

■ ■ ⊕ IP20 INCLUSA

2,480 Kg / 0,0263 m³
GX53 max 4 x 15W

€ 228

134901 Bianco

■ ■ ⊕ IP20 INCLUSA

1,620 Kg / 0,0159 m³
GX53 max 4 x 15W

€ 136

134895 Bianco

■ ■ ⊕ IP20 INCLUSA

0,700 Kg / 0,0088 m³
GX53 max 1 x 15W

€ 90

134888 Bianco

● 3000 K
910 lm

123936 € 6,00

● 3000 K
910 lm

123936 € 6,00

● 3000 K
910 lm

123936 € 6,00



Celine

Base in metallo smaltato. Diffusore in vetro trasparente sabbato. Viti ferma vetro in metallo cromato.

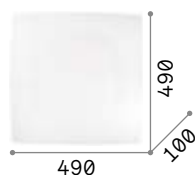

IP20

2,540 Kg / 0,0467 m³
E27 max 4x60W

€ 105

044293 Bianco

101286 3000 K
340 lm

101286 € 3,00

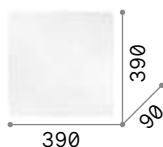

IP20

1,740 Kg / 0,0296 m³
E27 max 3x60W

€ 64

044286 Bianco

101286 3000 K
340 lm

101286 € 3,00

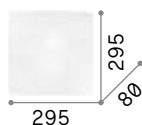

IP20

1,120 Kg / 0,0189 m³
E27 max 2x60W

€ 49

044279 Bianco

101286 3000 K
340 lm

101286 € 3,00

Ocean

Diffusore composto da due lastre di vetro: sotto con bordo a specchio e smerigliato al centro, sopra con decorazione serigrafata e applicazioni di bottoni in vetro.

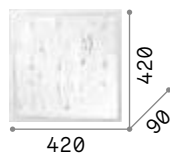

IP20

2,930 Kg / 0,0281 m³
E27 max 3x60W

€ 110

081441 Trasparen.
091013 Color

101286 3000 K
340 lm

101286 € 3,00

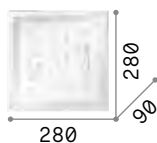

IP20

1,930 Kg / 0,0160 m³
E27 max 2x60W

€ 75

081434 Trasparen.
091006 Color

101286 3000 K
340 lm

101286 € 3,00

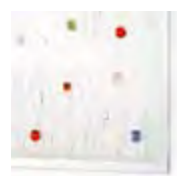

091013



0801441



Relax

Montatura in metallo rifinito con vernice opaca bianca. Diffusori in policarbonato opale. Doppia emissione luminosa: principale e laterale. Sorgente LED sostituibile. Alimentatore dimmerabile integrato.

LED Sorgente luminosa LED 3000 K, 17.500 h di durata.

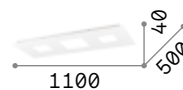

8,190 Kg / 0,0740 m³
LED 78W / 5250 lm

€ 450

255941 Bianco

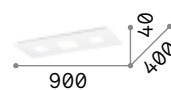

5,760 Kg / 0,0486 m³
LED 58W / 4600 lm

€ 400

255934 Bianco



Totem

Base in metallo sagomato a laser e verniciato bianco opaco. Sorgenti luminose a LED sostituibili.

LED Lampadine LED GX53 9W 3000 K include. Cod. **123936**

■ IP20 INCLUSA	■ IP20 INCLUSA	■ IP20 INCLUSA
5,320 Kg / 0,0470 m³ GX53 max 6 x 15W	3,890 Kg / 0,0322 m³ GX53 max 4 x 15W	2,960 Kg / 0,0227 m³ GX53 max 3 x 15W
€ 260	€ 210	€ 185
215785 Bianco	215778 Bianco	215761 Bianco
3000 K 910 lm	3000 K 910 lm	3000 K 910 lm
123936 € 6,00	123936 € 6,00	123936 € 6,00



Gingle

Base e corpo luce in metallo verniciato a polveri. Sorgente luminosa a led integrati con emissione di luce riflessa.



Sorgente luminosa LED 3000 K, 30.000 h di durata.

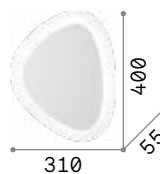

■ ■ □ IP20

1,540 Kg / 0,0233 m³
LED 35W / 2150 lm

€ 315

196220 Bianco

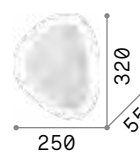

■ ■ □ IP20

1,000 Kg / 0,0139 m³
LED 26W / 1700 lm

€ 225

196206 Bianco

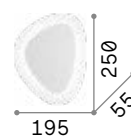

■ ■ □ IP20

0,730 Kg / 0,0153 m³
LED 19W / 1300 lm











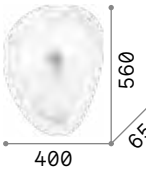
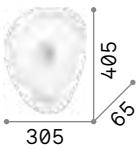
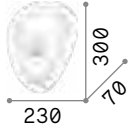

€ 165

196190 Bianco



Geko

Montatura in metallo smaltato bianco. Diffusore con vetro trasparente serigrafato in bianco. Elemento centrale fissa vetro in metallo cromato.

		
400	305	230
   IP20	   IP20	   IP20
3,820 Kg / 0,0385 m ³ E27 max 4 x 60W	2,000 Kg / 0,0203 m ³ E27 max 3 x 60W	1,200 Kg / 0,0130 m ³ E27 max 2 x 60W
€ 180	€ 120	€ 85
116112 Bianco	018508 Bianco	010861 Bianco
 3000 K 340 lm	 3000 K 340 lm	 3000 K 340 lm
101286 € 3,00	101286 € 3,00	101286 € 3,00

Glory

Montatura in metallo con finitura nickel satinato. Diffusore in vetro bianco soffiato e acidato.

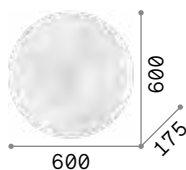

IP20

4,810 Kg / 0,1789 m³
E27 max 5 x 60W

€ 350

019765 Bianco

3000 K
340 lm
101286 € 3,00

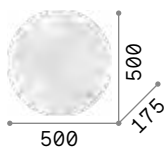

IP20

3,410 Kg / 0,0744 m³
E27 max 3 x 60W

€ 220

019758 Bianco

3000 K
340 lm
101286 € 3,00

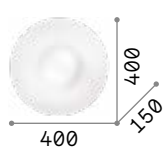

IP20

2,100 Kg / 0,0700 m³
E27 max 2 x 60W

€ 195

101132 Bianco

3000 K
340 lm
101286 € 3,00



P. 153

Level

Base in metallo verniciato a polveri. Diffusore in vetro soffiato bianco acidato con sistema di fissaggio senza viti. Sorgente a led integrato facilmente sostituibile.

LED Sorgente luminosa LED 3000 K, 17.500 h di durata.

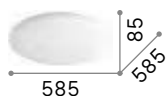

IP20

5,120 Kg / 0,1122 m³
LED 37,5W / 3300 lm

€ 290

261188 Bianco

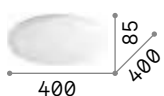

IP20

2,360 Kg / 0,0541 m³
LED 22,5W / 2100 lm

€ 180

261164 Bianco





Smarties

Montatura in metallo verniciato bianco. Diffusore in vetro bianco soffiato.

600 600 120	500 500 120	425 425 120	330 330 100
4,690 Kg / 0,1480 m ³ E27 max 3 x 60W	3,070 Kg / 0,1009 m ³ E27 max 3 x 60W	2,810 Kg / 0,0599 m ³ E27 max 2 x 60W	1,440 Kg / 0,0454 m ³ E27 max 1 x 60W
€ 280	€ 195	€ 170	€ 115
032023 Bianco	032030 Bianco	032047 Bianco	009223 Bianco
3000 K 340 lm	3000 K 340 lm	3000 K 340 lm	3000 K 340 lm
101286 € 3,00	101286 € 3,00	101286 € 3,00	101286 € 3,00



P. 152



P. 375



P. 460

Arizona

Montatura in metallo rifinito in ottone satinato. Diffusore in vetro bianco soffiato, acidato e con rigature decorative in rilievo.

LED Lampadine LED GX53 9W 3000 K incluse. Cod. **123936**

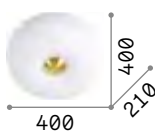
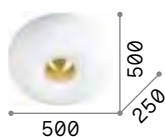

7,680 Kg / 0,1299 m³
GX53 max 5 x 15W

3,050 Kg / 0,0744 m³
GX53 max 3 x 15W

2,960 Kg / 0,0452 m³
GX53 max 2 x 15W

€ 505

€ 330

€ 225

214511 Bianco

214504 Bianco

214498 Bianco

3000 K
910 lm

3000 K
910 lm

3000 K
910 lm

123936 € 6,00

123936 € 6,00

123936 € 6,00



P. 154

Mapa Bianco

Base e sistema di fissaggio in metallo bianco. Diffusore a sfera in vetro bianco soffiato e acidato.

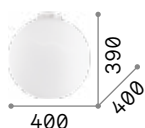

2,590 Kg / 0,1290 m³
E27 max 1 x 60W

€ 188

059839 Bianco

3000 K
910 lm



119571 € 7,00

P. 162

P. 374

P. 461





Candy

Montatura in metallo con finitura nickel satinato. Diffusore in vetro bianco soffiato e acidato.

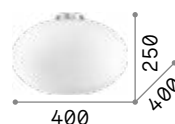

IP20

2,500 Kg / 0,0799 m³
E27 max 1x60W

€ 197

086781 Bianco

3000 K
900 lm

123899 € 7,00



P. 155



P. 460

Ovalino

Montatura in metallo smaltato.
Diffusore con elementi in lastra di vetro curvata e acidata.

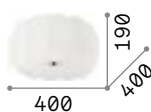
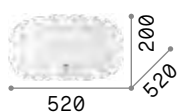

IP20

IP20

7,700 Kg / 0,1448 m³
E27 max 8 x 60W

5,100 Kg / 0,1202 m³
E27 max 5 x 60W

€ 320

€ 250

094014 Bianco

093963 Bianco

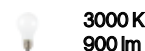

123899 € 7,00

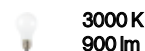

123899 € 7,00



P. 172 P. 372



Cloud

Montatura ed elementi decorativi in metallo rifinito con vernice opaca.
Diffusori in acrilico opale. Emissione luce indiretta. Colore: bianco.

LED Sorgente luminosa LED 3000 K,
17.500 h di durata.

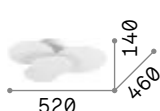

IP20

IP20

4,700 Kg / 0,0792 m³
LED 46W / 4000 lm

3,200 Kg / 0,0647 m³
LED 33W / 2900 lm

€ 310

€ 210

285207 Bianco

263519 Bianco





Ziggy new

Corpo luce in metallo verniciato a polveri. Pareti interne diffondenti in policarbonato opale satinato.

LED Sorgente luminosa LED 3000 K, 50.000 h di durata.



293776



193769

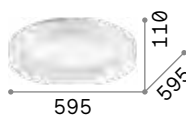

■ ■ □ IP20

4,000 Kg / 0,0553 m³
LED 42W / 5500 lm

€ 300

293790 **Bianco** new
307213 **Nero** new

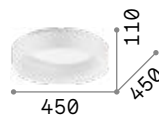

■ ■ □ IP20

2,500 Kg / 0,0324 m³
LED 30W / 3800 lm

€ 200

293783 **Bianco** new
307206 **Nero** new

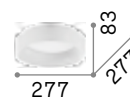

■ ■ □ IP20

1,350 Kg / 0,0096 m³
LED 22W / 2300 lm

€ 140

293776 **Bianco** new
293769 **Nero** new



Mix Up new

Montatura e paralumi intercambiabili in metallo verniciato a polveri. Interno bianco con finiture: bianco oppure nero.

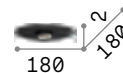
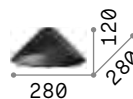
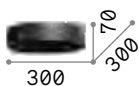
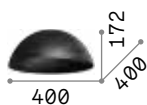
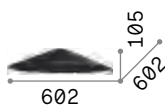
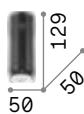

0,270 Kg / 0,005 m³
E27 max 1x60W

€ 40

292847 **Bianco** new
292830 **Nero**

2,000 Kg / 0,0676 m³

€ 175

288437 **Bianco** new
288420 **Nero**

1,100 Kg / 0,0446 m³

€ 110

307404 **Bianco** new
288475 **Nero**

0,800 Kg / 0,0147 m³

€ 90

307411 **Bianco** new
288444 **Nero**

0,500 Kg / 0,0174 m³

€ 90

307428 **Bianco** new
288451 **Nero**

0,340 Kg / 0,0008 m³

€ 65

307435 **Bianco** new
288482 **Nero** new

3000 K
900 lm

123899 € 7,00



P. 192 P. 424 P. 476 P. 522

Set Up new

Montature in metallo verniciato a polveri. Paralumi in pvc ignifugo rivestito di tessuto. Colori paralumi: beige, tortora, bianco o nero.



260457

304625

270012

260464



0,300 Kg / 0,0010 m³
E27 max 1x60W

€ 35

277288 Bianco new

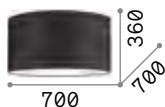

1,260 Kg / 0,2131 m³

€ 116

260471 Bianco
304632 Tortora new
270029 Nero
260488 Beige

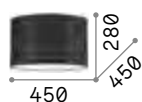

0,047 Kg / 0,0768 m³

€ 85

260457 Bianco
304625 Tortora new
270012 Nero
260464 Beige

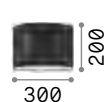

0,023 Kg / 0,0238 m³

€ 55

260433 Bianco
304618 Tortora new
270005 Nero
260440 Beige



0,012 Kg / 0,0180 m³

€ 28

260327 Bianco
304601 Tortora new
269986 Nero
260334 Beige



3000K
900lm

123899

€ 7,00



122205

122212

090863

Woody

Montatura in metallo cromato.
Diffusore in PVC o in tessuto,
chiuso sul fondo da vetro
trasparente acidato.



6,000 Kg / 0,1352 m³
E27 max 5 x 60W

€ 250

122205 Bianco
122212 Nero
090863 Legno

 3000 K
900 lm

123899 € 7,00

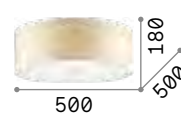

3,800 Kg / 0,0908 m³
E27 max 4 x 60W

€ 185

103266 Bianco
103273 Nero
090900 Legno

 3000 K
900 lm

123899 € 7,00

Wheel

Base e telaio in metallo smaltato.
Paralume in lamina di PVC ignifugo,
rivestita di tessuto.

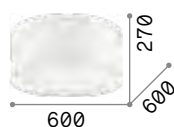

3,890 Kg / 0,1270 m³
E27 max 5 x 60W

€ 255

036021 Bianco



123899 € 7,00

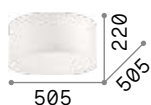

2,280 Kg / 0,0758 m³
E27 max 3 x 60W

€ 130

036014 Bianco



123899 € 7,00



P. 190



Ritz

Base in metallo smaltato. Paralume
e pannello diffusore inferiore in
lamina di PVC rivestita di tessuto.

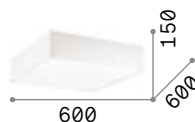

1,710 Kg / 0,0968 m³
E27 max 4 x 60W

€ 250

152912 Bianco

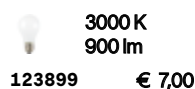

123899 € 7,00

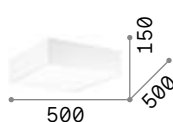

1,480 Kg / 0,0700 m³
E27 max 4 x 60W

€ 200

152899 Bianco



123899 € 7,00

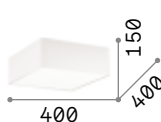

1,110 Kg / 0,0444 m³
E27 max 4 x 52W

€ 155

152875 Bianco

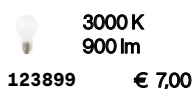

123899 € 7,00



Simply

Diffusore in vetro trasparente sabbato. Ganci ferma vetro in metallo cromato con sistema di bloccaggio a molla.

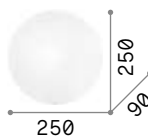
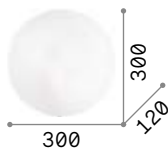
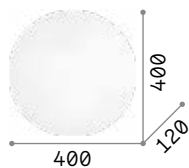
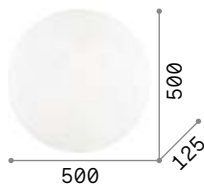

3,190 Kg / 0,0511 m³
E27 max 4 x 60W

€ 85

007991 Bianco

101286 3000 K
340 lm

101286 € 3,00

1,670 Kg / 0,0284 m³
E27 max 3 x 60W

€ 54

007984 Bianco

101286 3000 K
340 lm

101286 € 3,00

1,010 Kg / 0,0107 m³
E27 max 2 x 60W

€ 37

007977 Bianco

101286 3000 K
340 lm

101286 € 3,00

0,670 Kg / 0,0060 m³
E27 max 1 x 60W

€ 28

007960 Bianco

101286 3000 K
340 lm

101286 € 3,00

Lana

Diffusore in vetro trasparente con decorazioni serigrafate all'interno e sabbato all'esterno. Ganci ferma vetro in metallo cromato.

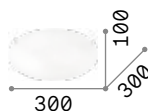
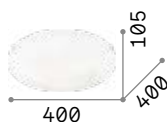

1,500 Kg / 0,0279 m³
E27 max 3 x 60W

€ 68

068145 Bianco

101286 3000 K
340 lm

101286 € 3,00

0,800 Kg / 0,0168 m³
E27 max 2 x 60W

€ 46

068138 Bianco

101286 3000 K
340 lm

101286 € 3,00



P. 150





Shell

Diffusore di vetro trasparente lavorato in piastra e decorato all'interno con graniglia. Blocca vetro con dettaglio in metallo. Disponibile trasparente con dettaglio cromato o ambra con dettaglio ottonato.



008622



140193

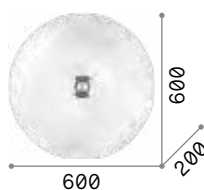

8,850 Kg / 0,0943 m³
E27 max 6 x 60W

€ 290

008622 Trasparen.
140193 Ambra

3000 K
430 lm

101279 € 3,00

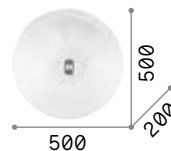

6,150 Kg / 0,0647 m³
E27 max 4 x 60W

€ 210

008615 Trasparen.
140186 Ambra

3000 K
430 lm

101279 € 3,00

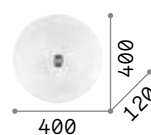

3,940 Kg / 0,0381 m³
E27 max 3 x 60W

€ 140

008608 Trasparen.
140179 Ambra

3000 K
430 lm

101279 € 3,00



Gemma

Base in plastica con varie finiture.
Diffusore in policarbonato bianco opaco. Sistema di fissaggio rapido.



Sorgente luminosa LED 3000 K,
20.000 h di durata.



252612



252629

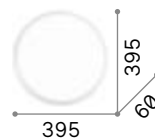

0,760 Kg / 0,0275 m³
LED 24W / 2880 lm

€ 40

252612 ■ Bianco
252629 ■ Nero

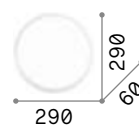

0,430 Kg / 0,0164 m³
LED 12W / 1440 lm

€ 30

252599 ■ Bianco
252605 ■ Nero



Aura **new**

Corpoluce e diffusore in materiale plastico opaco. Apparecchio per installazione in superficie o a incasso. Disponibile con sensore crepuscolare e di movimento. Finiture: bianco oppure nero.

LED Sorgente luminosa LED 3000/4000 K, 30.000 h di durata.

PIR Lampada con rilevazione di presenza PIR (Passive InfraRed) e sensore crepuscolare inclusi.

P. 696

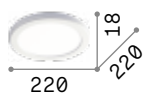

0,350 Kg / 0,0018 m³
LED 20W / 1950/2000 lm

€ 50

290799 3000K
306346 4000K
290775 3000K
306360 4000K

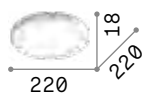

0,350 Kg / 0,0018 m³
LED 20W / 1950/2000 lm

€ 60

new 290805 3000K
new 306353 4000K
new 290782 3000K
new 306377 4000K

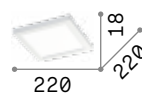

0,400 Kg / 0,0018 m³
LED 20W / 1950/2000 lm

€ 58

new 290836 3000K
new 306384 4000K
new 290812 3000K
new 306407 4000K

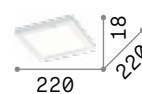

0,400 Kg / 0,0018 m³
LED 20W / 1950/2000 lm

€ 66

new 290843 3000K
new 306391 4000K
new 290829 3000K
new 306414 4000K



Look

Base di fissaggio in alluminio tornito. Diffusore cilindrico in metallo verniciato a polveri bianco o nero oppure in ottone satinato.

LED Lampadine LED GU10 7W 3000 K incluse. Cod. **123943**

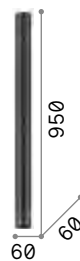

3,070 Kg / 0,0061 m³
GU10 max 1x28W

€ 86

259260 ■ Bianco
259277 ■ Nero



3000 K
610 lm

123943 € 4,50



1,380 Kg / 0,0037 m³
GU10 max 1x28W

€ 68

233352 ■ Bianco
233321 ■ Nero



3000 K
610 lm

123943 € 4,50

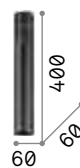

0,740 Kg / 0,0025 m³
GU10 max 1x28W

€ 56

233215 ■ Bianco
233192 ■ Nero



3000 K
610 lm

123943 € 4,50

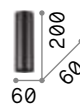

0,400 Kg / 0,0013 m³
GU10 max 1x28W

€ 46

233079 ■ Bianco
233062 ■ Nero
285214 ■ Ottone



3000 K
610 lm

123943 € 4,50



P.074



P.371



P.641



Sky

Corpo luce diffusore in metallo verniciato a polveri con finitura bianca o nera. Sistema di fissaggio senza viti a vista.

LED Lampadine LED GU10 7W 3000 K incluse. Cod. **123943**



■ □ IP20  INCLUSA

1,940 Kg / 0,0047 m³
GU10 max 1x28W

€ 105

234007 **Bianco**
233970 **Nero**

 **3000 K**
610 lm
123943 € 4,50

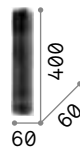

■ □ IP20  INCLUSA

1,090 Kg / 0,0027 m³
GU10 max 1x28W

€ 91

233833 **Bianco**
233826 **Nero**

 **3000 K**
610 lm
123943 € 4,50

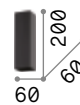

■ □ IP20  INCLUSA

0,600 Kg / 0,0016 m³
GU10 max 1x28W

€ 72

233772 **Bianco**
233765 **Nero**

 **3000 K**
610 lm
123943 € 4,50

 
P. 077 P. 370



Nitro

Corpo luce in alluminio verniciato bianco o nero opachi. Interno rifinito con mascherina in plastica. Sorgente luminosa a led integrato con lente.

LED Sorgente luminosa LED 3000 K, 50.000 h di durata.



206035

206042

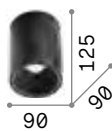

IP20

0,910 Kg / 0,0030 m³
LED 15W / 1350 lm

€ 90

205977 ■ Bianco
205984 ■ Nero

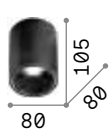

IP20

0,390 Kg / 0,0013 m³
LED 10W / 1100 lm

€ 65

205991 ■ Bianco
206004 ■ Nero

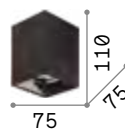

IP20

0,400 Kg / 0,0013 m³
LED 15W / 1350 lm

€ 90

206011 ■ Bianco
206028 ■ Nero

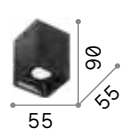

IP20

0,230 Kg / 0,0005 m³
LED 10W / 1100 lm

€ 65

206035 ■ Bianco
206042 ■ Nero



Mood

Corpo luce in metallo disponibile con sezione quadra o tonda. Nero all'interno e bianco o nero all'esterno. Diffusore interno orientabile.

LED Lampadine GU10 7W e GU10 10W 3000 K incluse.



140841



243924

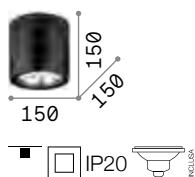

1,210 Kg / 0,0061 m³
GU10 max 1x 50W

€ 97

140872 **Bianco**
243450 **Nero**

3000 K
800 lm

189031 € 15,00

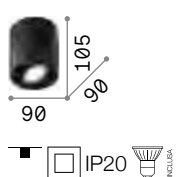

0,400 Kg / 0,0022 m³
GU10 max 1x 28W

€ 64

140841 **Bianco**
243924 **Nero**

3000 K
610 lm

123943 € 4,50

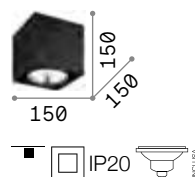

1,420 Kg / 0,0068 m³
GU10 max 1x 50W

€ 97

140933 **Bianco**
243931 **Nero**

3000 K
800 lm

189031 € 15,00

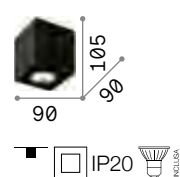

0,460 Kg / 0,0023 m³
GU10 max 1x 28W

€ 64

140902 **Bianco**
243948 **Nero**

3000 K
610 lm

123943 € 4,50



Dot **new**

Base e corpo luce e ghiera in alluminio verniciato a polveri. Diffusore in acrilico trasparente satinato. Apparecchio per installazione in superficie. Finiture: bianco oppure nero.

LED Sorgente luminosa LED 3000/4000 K, 30.000 h di durata.



299419



299402



IP20

0,600 Kg / 0,0004 m³
LED 4,5W / 350/37 lm

€ 58

299419	Bianco	3000K	new
306513	Bianco	4000K	new
299402	Nero	3000K	new
306520	Nero	4000K	new



Spike

Corpo luce e base in alluminio tornito verniciato a polveri o placcato. Sorgente luminosa a led sostituibile. Colori: bianco, nero oppure ottone satinato.

LED Lampadine LED GX53 9W 3000 K incluse. Cod. **123936**



277417



278704



285238

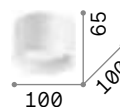

0,240 Kg / 0,0017 m³
GX53 max 1x 15W

€ 80

277417 Bianco
278704 Nero
285238 Ottone

3000 K
910 lm

123936 € 6,00

Oak

Corpo luce in gesso o cemento.
Elemento portalampada centrale orientabile in metallo verniciato.

 Articolo adatto alla pittura e verniciatura.

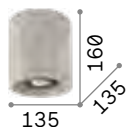

■ □ IP20

1,730 Kg / 0,0082 m³
GU10 max 1x 35W

€ 76

150420 Bianco
150437 Cemento

 3000 K
440 lm

108292 € 4,50

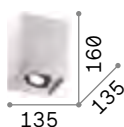

■ □ IP20

2,210 Kg / 0,0078 m³
GU10 max 1x 35W

€ 76

150468 Bianco
150475 Cemento

 3000 K
440 lm

108292 € 4,50



P. 076



Tower

Base di fissaggio in materiale
plastico con sistema a baionetta.
Corpo luce interamente in gesso.
Monta lampadine GU10 sostituibili.

 Articolo adatto alla pittura e verniciatura.



■ □ IP20

0,430 Kg / 0,0023 m³
GU10 max 1x 35W

€ 39

155869 Bianco

 3000 K
440 lm

108292 € 4,50

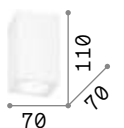

■ □ IP20

0,620 Kg / 0,0023 m³
GU10 max 1x 35W

€ 39

155791 Bianco

 3000 K
440 lm

108292 € 4,50

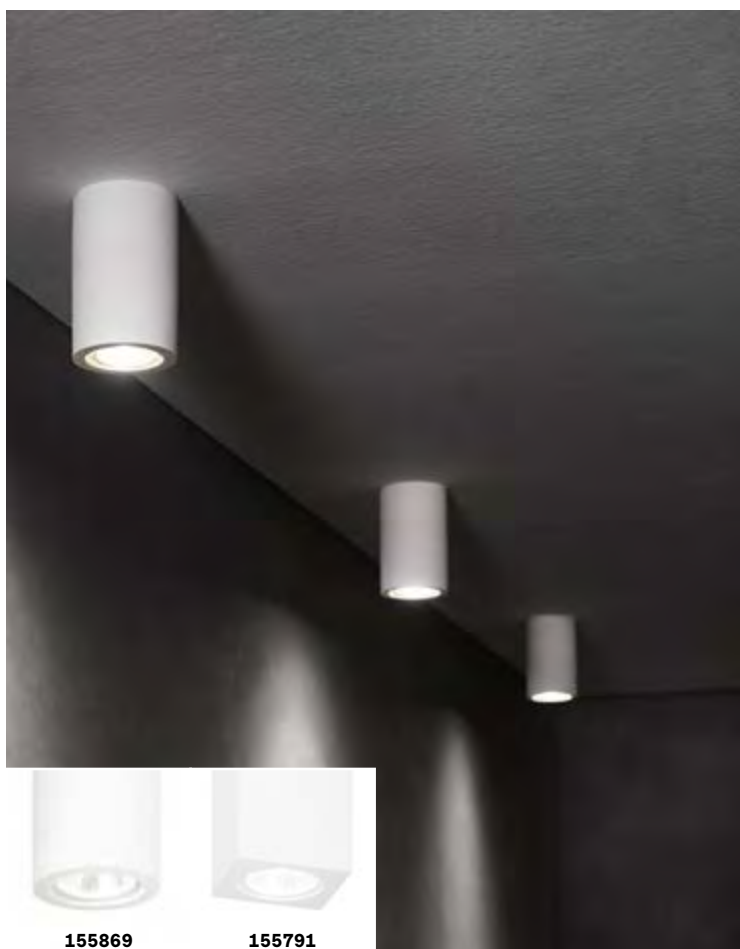



Lika Surface

Famiglia di moduli LED rettangolari in alluminio pressofuso, verniciato nero o bianco con riflettore in policarbonato. Moduli disponibili con cinque lenti. Appositamente disegnato per evitare abbagliamenti ($UGR < 16$), trova la sua migliore collocazione all'interno di UFFICI e spazi COMMERCIALI.

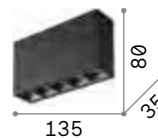

IP20

0,370 Kg / 0,0011 m³
LED 12,5W / 1200 lm

€ 90

248530 ■ Bianco
244884 ■ Nero



Sorgente luminosa LED 3000 K,
50.000 h di durata.



P. 704



Dynamite

Montatura in metallo rifinito con vernice a polveri o placcato e spazzolato. Diffusori orientabili.



Lampadine LED GU10 7W 3000 K incluse. Cod. **123943**

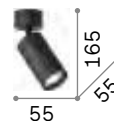

0,430 Kg / 0,0037 m³
GU10 max 1x28W

€ 98

231495 ■ Bianco
231471 ■ Nero
244662 ■ Ottone

3000 K
610 lm

123943 € 4,50



P. 088

Play

Base, snodo e corpo luce orientabile in alluminio pressofuso verniciato a polveri. Diffusore in acrilico trasparente zigrinato. Disponibile nelle finiture nero oppure bianco con cover posteriore e ghiera frontale interni neri.

LED Sorgente luminosa LED 3000 K, 30.000 h di durata.

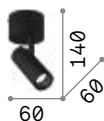

IP20

0,240 Kg / 0,0010 m³
LED 7W / 520 lm

€ 85

258287 Bianco
268101 Nero



P. 698



Toby

Montatura in alluminio pressofuso verniciato a polveri. Diffusori orientabili in rotazione e inclinazione. Colori: bianco o nero.

LED Lampadine LED GU10 7W 3000 K incluse. Cod. 123943

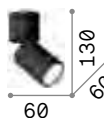

IP20

0,220 Kg / 0,0008 m³
GU10 max 1x 35W

€ 50

271538 Bianco
271545 Nero

3000 K
610 lm

123943 € 4,50

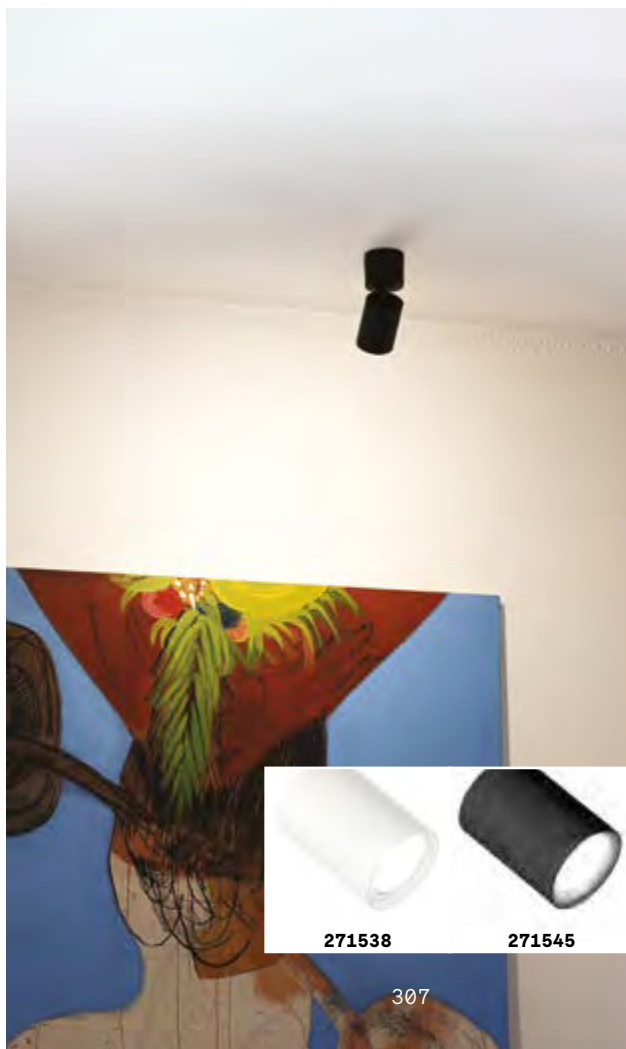



Petit

Corpo luce in metallo placcato o verniciato opaco. Sistema di fissaggio senza viti a vista. Disponibile con finitura bianca, cromo, ottone e nero.



Lampadine LED E27 8W Globo D95 3000 K include. Cod. **101330**



232966



233017



232980



233031

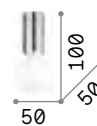

0,790 Kg / 0,0071 m³
E27 max 1x60W

€ 38

232966 Bianco
233017 Cromo
232980 Nero
233031 Ottone

3000 K
950 lm

101330 € 8,00



Winery

Corpo luce con portalampane incorporato interamente in ceramica con finitura in smalto lucido bianco o nero.



155227

155142

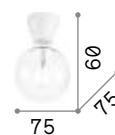

IP20

0,290 Kg / 0,0004 m³
E27 max 1x 60W

€ 24

155227 ■ Bianco
155142 ■ Nero

3000 K
1120 lm

101323 € 7,50



P. 408

Mouse

Base, montatura e diffusori in metallo rifinito con vernice opaca e dettagli in cromo. Diffusori orientabili. Disponibile nelle finiture bianco o nero.

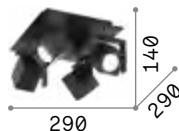

■ □ ⊕ IP20

1,900 Kg / 0,0157 m³
GU10 max 4 x 50W

€ 260

073583 Bianco
156712 Nero



108292 € 4,50



P. 404 P. 638



073583

156712

Spot

Base, montatura e diffusori in metallo rifinito con vernice opaca e dettagli in cromo. Diffusori orientabili. Disponibile nelle finiture bianco o nero.



■ □ ⊕ IP20

1,320 Kg / 0,0139 m³
GU10 max 4 x 50W

€ 100

156774 Bianco
156781 Nero

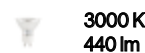

108292 € 4,50



P. 404 P. 638



156774

156781

Rudy

Montatura in alluminio pressofuso verniciato a polveri bianco o nero. Diffusori orientabili in rotazione e inclinazione.

LED Lampadine LED GU10 7W 3000 K incluse. Cod. **123943**

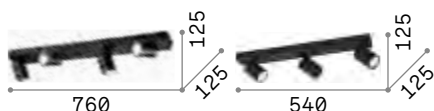

1,230 Kg / 0,0057 m³
GU10 max 4 x 35W

€ 185

229089 Bianco
229072 Nero

1,080 Kg / 0,0041 m³
GU10 max 3 x 35W

€ 127

229065 Bianco
229058 Nero

3000 K
610 lm

123943 € 4,50

3000 K
610 lm

123943 € 4,50



P. 405



Oby

Montatura in metallo verniciato bianco opaco, con snodi cromati. Corpo luce orientabile con diffusore in materiale plastico bianco.

LED Sorgente luminosa LED 3000 K, 20.000 h di durata.

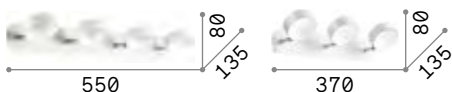

1,210 Kg / 0,0058 m³
LED 24W / 2800 lm

€ 260

196718 Bianco



0,870 Kg / 0,0038 m³
LED 18W / 2100 lm

€ 185

196701 Bianco



P. 406





Konig **new**

Base e montatura in alluminio verniciato a polveri. Braccio e ghiera porta lampada orientabili. Cavo esterno rivestito con guaina a calza. Colore: bianco o nero.

LED Lampadine LED GU10 10W 3000 K incluse. Cod. **189031**



284866

284859



P. 640

2,100 Kg / 0,0194 m ³ GU10 max 4 x 50W	1,000 Kg / 0,0099 m ³ GU10 max 2 x 50W	0,500 Kg / 0,0067 m ³ GU10 max 1 x 50W
€ 350	€ 175	€ 90
300573 Bianco new 300580 Nero new	300559 Bianco new 300566 Nero new	284866 Bianco new 284859 Nero new
3000 K 800 lm	3000 K 800 lm	3000 K 800 lm
189031 € 15,00	189031 € 15,00	189031 € 15,00



Glim

Montatura interamente in metallo verniciato a polveri di colore bianco o nero. Diffusore orientabile con lampadina sostituibile.

LED Lampadine LED GU10 10W 3000 K incluse. Cod. **189031**









200194

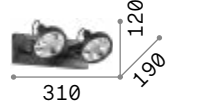
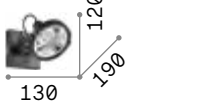

200231



P. 640

		
655	310	130
		
1,270 Kg / 0,0202 m ³ GU10 max 4 x 50W	0,890 Kg / 0,0074 m ³ GU10 max 2 x 50W	0,480 Kg / 0,0034 m ³ GU10 max 1 x 50W
€ 265	€ 145	€ 75
200217 Bianco 200255 Nero	200200 Bianco 200248 Nero	200194 Bianco 200231 Nero
 3000 K 800 lm	 3000 K 800 lm	 3000 K 800 lm
189031 € 15,00	189031 € 15,00	189031 € 15,00

Alfa

Montatura in metallo con finitura in bianco satinato, nickel satinato od ottone satinato. Corpo luce posizionabile con rotazione dello stelo e snodo per l'inclinazione.

LED Lampadine LED GU10 7W 3000 K incluse. Cod. **123943**

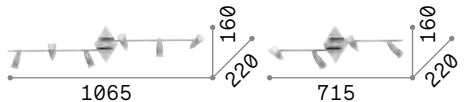

1,140 Kg / 0,0196 m³
GU10 max 6 x 50W

€ 135

122748 **Bianco**
006338 **Nickel**
287805 **Ottone**

1,070 Kg / 0,0158 m³
GU10 max 4 x 50W

€ 90

122731 **Bianco**
006321 **Nickel**
287799 **Ottone**

3000 K
610 lm

123943 € 4,50

3000 K
610 lm

123943 € 4,50



P. 407



122731

006321

287799

Slem

Montatura in metallo con finitura in bianco, cromo, nickel satinato od ottone satinato. Corpo luce posizionabile con rotazione dello stelo e snodo per l'inclinazione.

LED Lampadine LED GU10 7W 3000 K incluse. Cod. **123943**

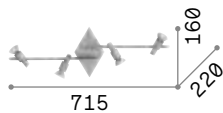

1,070 Kg / 0,0152 m³
GU10 max 4 x 50W

€ 92

142098 **Bianco**
142067 **Cromo**
018850 **Nickel**
287812 **Ottone**

3000 K
610 lm

123943 € 4,50



P. 407



142098

142067

018850

287812



Maracas

Montatura interamente in metallo rifinito in bianco od ottone satinato. Diffusori orientabili in vetro soffiato trasparente.

LED Lampadine LED G4 2W 3000 K incluse.
Cod. 222257



200392

200354



1,280 Kg / 0,0242 m³
G4 max 6 x 2W

€ 374

200408 ■ Bianco
200361 ■ Ottone

 3000 K
160 lm

222257 € 4,50



0,960 Kg / 0,0142 m³
G4 max 4 x 2W

€ 269

200392 ■ Bianco
200354 ■ Ottone

 3000 K
160 lm

222257 € 4,50



P. 416

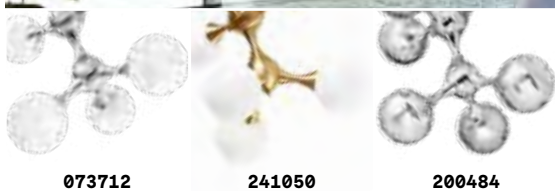

073712

241050

200484

Nodi

Montatura in metallo cromato oppure in ottone satinato. Diffusori in vetro bianco soffiato, acidato o trasparente e cromato.

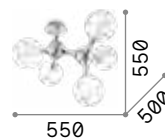

IP20

3,200 Kg / 0,1012 m³
E14 max 5 x 40W

€ 210

073712 Bianco
241050 Ottone

 3000 K
480 lm
101200 € 3,00

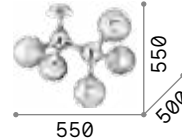

IP20

3,200 Kg / 0,1012 m³
E14 max 5 x 40W

€ 270

200484 Cromo

 3000 K
480 lm
101200 € 3,00



P. 171

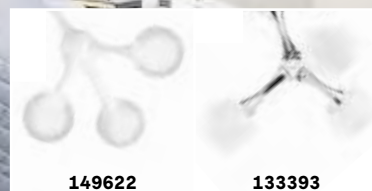

Nodino

Montatura in metallo con finitura in cromo o in vernice opaca bianca. Diffusori in vetro bianco soffiato e acidato.

LED Lampadine LED G9 3W 3000 K incluse.
Cod. **209043**

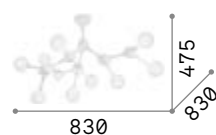

3,160 Kg / 0,3975 m³
G9 max 9 x 15W

€ 540

149622 **Bianco**
133393 **Cromo**

3000 K
370 lm
209043 € 3,90



Triumph

Base, bracci e copri porta lampade in metallo con finitura nero opaco o ottone invecchiato.



242378



160313

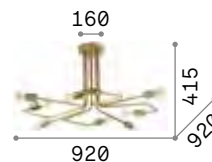

IP20

3,270 Kg / 0,0454 m³
E27 max 8 x 60W

€ 570

242378 ■ Nero
160313 ■ Ottone

2200 K
370 lm

151687 € 5,50



Birds

Montatura in metallo verniciato con disco decorativo in ottone satinato. Diffusori in vetro soffiato bianco acidato. Colore: nero opaco con dettaglio ottone satinato.

LED Lampadine LED G9 3W 3000 K incluse.
Cod. **209043**

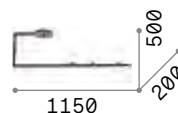

2,800 Kg / 0,1535 m³
G9 max 5 x 15W

€ 278

273631 ■ Nero

3000 K
370 lm

209043

€ 3,90



P. 094

P. 413

P. 466

P. 492



Dea

Montatura a semi-sfera e copri porta lampade in metallo cromato. Lampade a LED sostituibili.

LED

Lampadine LED E27 2W Globo D125 trasparente 3000 K incluse.
Cod. **184470**

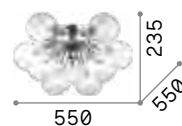

3,300 Kg / 0,0777 m³
E27 max 10 x 20W

€ 340

074740 ■ Cromo

 3000 K
1020 lm

101347 € 8,50



Pauline

Montatura in metallo cromato.
Elementi decorativi in vetro
trasparente modellato a mano e
cromato.

LED Lampadine LED G9 3W 3000 K incluse.
Cod. **209043**

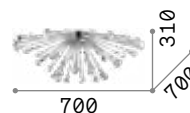

3,500 Kg / 0,0380 m³
G9 max 5 x 40W

€ 500

111117 ■ **Fumè**

3000 K
370 lm

209043 **€ 3,90**



P. 102



Multiflex

Montatura in metallo rifinito con vernice opaca. Bracci flessibili metallici, rivestiti in gomma.

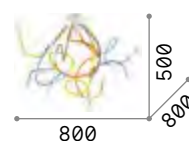

IP20

4,330 Kg / 0,0353 m³
E14 max 8 x 40W

€ 410

159010  Color

 3000 K
420 lm

101217 € 3,00



P. 175



Octopus

Base in metallo rifinito opaco.
Bracci flessibili rivestiti di gomma di colore bianco o multicolor. Diffusori in vetro trasparente soffiato e sabbato.

LED

Lampadine LED G9 3W 3000 K incluse.
Cod. 209043



174921



174976

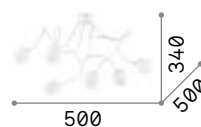

3,000 Kg / 0,0390 m³
G9 max 6 x 28W

€ 340

174921 ■ Bianco
174976 ■ Color

 3000 K
370 lm
209043 € 3,90

Spark

Montatura in metallo verniciato nero opaco con portalampane placcati.



■ □ IP20

2,730 Kg / 0,0864 m³
E27 max 20 x 25W

€ 425

238333 ■ Nero

💡 3000 K
1120 lm



101323 € 7,50 P. 101

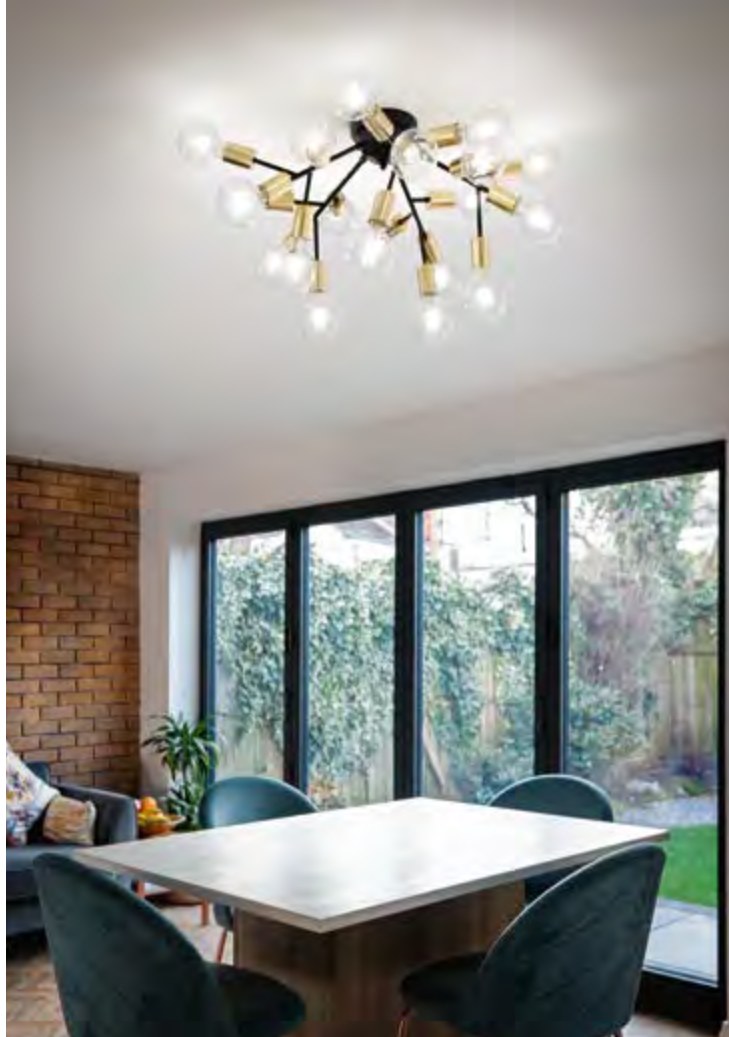

Gourmet ^{new}

Rosone e montatura in metallo verniciato opaco. Diffusori in vetro incamiciato bianco, soffiato e acidato. Finiture: nero e ottone satinato.

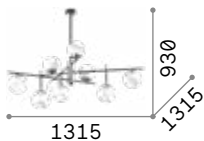

■ □ IP20

5,400 Kg / 0,1765 m³
E14 max 9 x 40W

€ 615

289489 ■ Nero

💡 3000 K
420 lm

101217 € 3,00

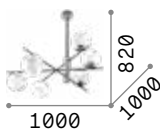

■ □ IP20

3,670 Kg / 0,1017 m³
E14 max 6 x 40W

€ 415

^{new} 289496 ■ Nero ^{new}

💡 3000 K
420 lm

101217 € 3,00





Cosmopolitan

Montatura in metallo rifinito con vernice opaca. Diffusori in vetro soffiato bianco acidato. Colori: tutto bianco o nero con dettagli ottone satinato.



Lampadine LED G9 3W 3000 K incluse.
Cod. 209043

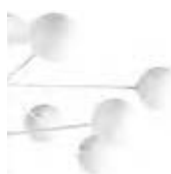

285245



273693



7,600 Kg / 0,1787 m³
G9 max 12 x 15W

€ 700

285252 ■ Bianco
273709 ■ Nero

3000 K
370 lm

209043 € 3,90

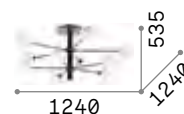

6,500 Kg / 0,1397 m³
G9 max 10 x 15W

€ 600

285245 ■ Bianco
273693 ■ Nero

3000 K
370 lm

209043 € 3,90



Angolo new

Montatura in metallo verniciato a polveri o placcato. Diffusori in vetro bianco, soffiato e acidato. Finiture: nero oppure ottone satinato.

LED

Lampadine LED G9 3W 3000 K incluse.
Cod. **209043**



284286

284330



IP20

1,650 Kg / 0,0377 m³
G9 max 3 x 28W

€ 185

284286 ■ Nero new
284330 ■ Ottone new



P. 467



P. 496

3000 K
370 lm

209043

€ 3,90



Lingotto

Montatura in metallo verniciato: base nera opaca e telaio ottone opaco. Diffusori in vetro incamiciato bianco, soffiato e acidato.



■ IP20

5,580 Kg / 0,0540 m³
E14 max 4 x 40W

€ 315

198156 ■ Ottone

3000 K
420 lm

101217 € 3,00



■ IP20

3,370 Kg / 0,0451 m³
E14 max 2 x 40W

€ 210

198149 ■ Ottone

3000 K
420 lm

101217 € 3,00



■ IP20

1,810 Kg / 0,0183 m³
E14 max 1 x 40W

€ 125

198132 ■ Ottone

3000 K
420 lm

101217 € 3,00



P. 092 P. 469





Hermes new

Base e montatura in metallo placcato. Diffusori in vetro incamiciato bianco, soffiato e acidato. Finiture: ottone satinato.



Lampadine LED G9 3W 3000 K incluse.
Cod. **209043**

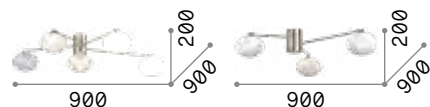

2,500 Kg / 0,0296 m³
G9 max 5 x 28W

€ 350

288277 ■ Ottone

3000 K
370 lm

209043 € 3,90



1,700 Kg / 0,0252 m³
G9 max 3 x 28W

€ 250

new 288260 ■ Ottone new

3000 K
370 lm

209043 € 3,90



Ninfea **new**

Base in metallo verniciato a polveri o placcato. Diffusori in vetro incamiciato bianco, soffiato e acidato. Finiture: bianco oppure ottone satinato.

LED

Lampadine LED GX53 9W 3000 K
includ. Cod. **123936**



306957



293653

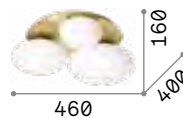

460



360



2,550 Kg / 0,0484 m³
GX53 max 3 x 15W

€ 250

1,700 Kg / 0,0302 m³
GX53 max 2 x 15W

€ 175

306964 **Bianco** **new**
293660 **Ottone** **new**

306957 **Bianco** **new**
293653 **Ottone** **new**

3000 K
910 lm

123936

€ 6,00

3000 K
910 lm

123936

€ 6,00



P. 421

Almond

Montatura in metallo verniciato bianco opaco. Elementi diffusori in vetro soffiato bianco incamiciato e acidato.

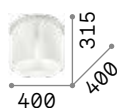

IP20

IP20

26,390 Kg / 0,3100 m³
E27 max 9 x 60W

7,610 Kg / 0,1048 m³
E27 max 3 x 60W

€ 600

€ 200

159645 Bianco

159638 Bianco

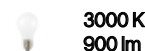

123899 € 7,00

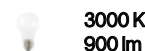

123899 € 7,00



Daisy

Base in metallo rifinita con foglia oro. Diffusori in vetro soffiato bianco, acidato e con rigatura in rilievo.



IP20

12,000 Kg / 0,1711 m³
E27 max 6 x 60W

€ 440

247779 Oro

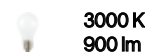

123899 € 7,00





Compo

Montatura in metallo cromato o verniciato bianco opaco. Elementi diffusori in vetro soffiato bianco incamiciato e acidato o trasparente fumè.



125503



172828



IP20

17,200 Kg / 0,3008 m³
E27 max 10 x 60W

€ 1000

125510 Bianco
172804 Fumè

3000 K
910 lm

119571 € 7,00



IP20

9,900 Kg / 0,1918 m³
E27 max 6 x 60W

€ 570

125503 Bianco
172828 Fumè

3000 K
910 lm

119571 € 7,00



Roma

Montatura e dettagli in metallo cromato. Diffusore con elementi quadrati in cristallo molato sulla fascia laterale e vetro sabbato sul fondo.



Lampadine LED G9 3W 3000 K incluse.
Cod. 209043

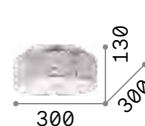
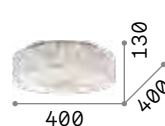

9,600 Kg / 0,1220 m³
G9 max 12 x 40W

6,800 Kg / 0,0905 m³
G9 max 9 x 40W

4,800 Kg / 0,0588 m³
G9 max 6 x 40W

2,500 Kg / 0,0390 m³
G9 max 4 x 40W

€ 640

€ 560

€ 385

€ 270

087870 Cromo

087863 Cromo

000657 Cromo

093093 Cromo



P. 203 P. 432 P. 482

3000 K
370 lm

3000 K
370 lm

3000 K
370 lm

3000 K
370 lm

209043 € 3,90

209043 € 3,90

209043 € 3,90

209043 € 3,90



Pashà

Montatura in metallo. Diffusore composto da filari di perle in cristallo molato e fondo chiuso da vetro circolare sabbato.



164991



165004



P. 205 P. 432

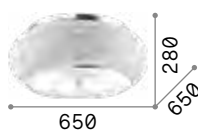

13,000 Kg / 0,1809 m³
E14 max 14 x 40W

€ 1145

164991 Cromo
165004 Oro

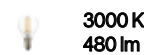

101200 € 3,00

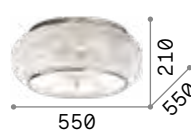

8,800 Kg / 0,1040 m³
E14 max 10 x 40W

€ 980

100746 Cromo
100791 Oro

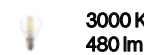

101200 € 3,00

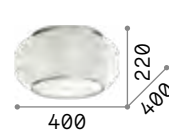

6,200 Kg / 0,0529 m³
E14 max 6 x 40W

€ 780

100784 Cromo
100807 Oro

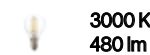

101200 € 3,00



King

Diffusore composto da anelli in metallo cromato o dorato con ottagononi di cristallo incastonati all'interno.

LED

Lampadine LED G9 3W 3000 K incluse.
Cod. **209043**



073255



073262



P. 196

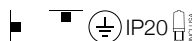
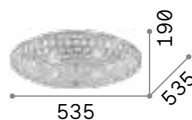

6,250 Kg / 0,0946 m³
G9 max 9 x 40W

€ 665

073255 Cromo
073262 Oro

3000 K
370 lm

209043 € 3,90

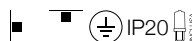
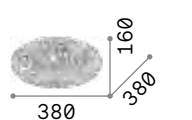

3,200 Kg / 0,0487 m³
G9 max 5 x 40W

€ 380

075419 Cromo
073187 Oro

3000 K
370 lm

209043 € 3,90

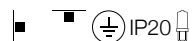
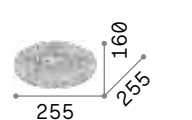

1,750 Kg / 0,0240 m³
G9 max 3 x 40W

€ 220

075389 Cromo
075402 Oro

3000 K
370 lm

209043 € 3,90



Admiral

Diffusore composto da anelli in metallo saldati tra loro e da elementi in cristallo molato incastonati all'interno.



Lampadine LED G9 3W 3000 K incluse.
Cod. 209043

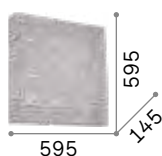

8,490 Kg / 0,1000 m³
G9 max 10 x 40W

€ 996

080291 Cromo

3000 K
370 lm

209043 € 3,90

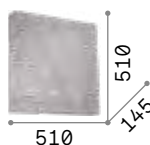

7,050 Kg / 0,0731 m³
G9 max 8 x 40W

€ 778

080352 Cromo

3000 K
370 lm

209043 € 3,90

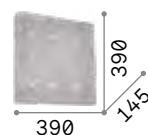

4,580 Kg / 0,0486 m³
G9 max 6 x 40W

€ 500

080345 Cromo

3000 K
370 lm

209043 € 3,90

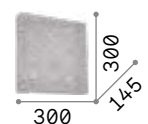

3,000 Kg / 0,0318 m³
G9 max 4 x 40W

€ 340

080338 Cromo

3000 K
370 lm

209043 € 3,90



101187

022239

Neve

Montatura in metallo. Elementi decorativi con sfere di vetro fissate a fili di nylon. Disponibile con montatura cromata e sfere trasparenti o con montatura in bianco opaco e sfere bianche e trasparenti.

LED

Lampadine LED G9 3W 3000 K incluse.
Cod. 209043

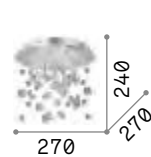
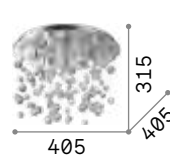
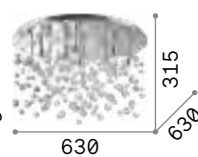
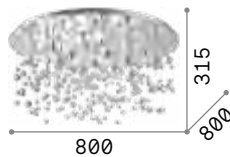

11,250 Kg / 0,1524 m³
G9 max 15 x 40W

7,420 Kg / 0,0920 m³
G9 max 12 x 40W

3,590 Kg / 0,0344 m³
G9 max 8 x 40W

1,500 Kg / 0,0149 m³
G9 max 5 x 40W

€ 760

€ 510

€ 305

€ 155

101194 Bianco
030784 Cromo

101187 Bianco
022239 Cromo

101170 Bianco
022222 Cromo

094687 Cromo

3000 K
370 lm

3000 K
370 lm

3000 K
370 lm

3000 K
370 lm

209043 € 3,90

209043 € 3,90

209043 € 3,90

209043 € 3,90

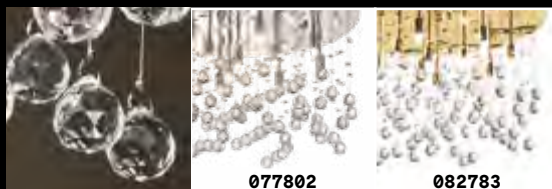

Moonlight

Montatura in metallo con finitura disponibile in cromo o dorato. Pendagli con ottagononi e sfere in cristallo molato.

LED Lampadine LED G9 3W 3000 K incluse.
Cod. 209043

IP20	IP20	IP20	IP20
11,800 Kg / 0,1524 m ³ G9 max 15 x 40W	6,000 Kg / 0,0933 m ³ G9 max 12 x 40W	2,900 Kg / 0,0398 m ³ G9 max 8 x 40W	1,500 Kg / 0,0144 m ³ G9 max 5 x 40W
€ 875	€ 605	€ 338	€ 170
077819 Cromo 082790 Oro	077802 Cromo 082783 Oro	077796 Cromo 080932 Oro	094649 Cromo 094663 Oro
3000 K 370 lm	3000 K 370 lm	3000 K 370 lm	3000 K 370 lm
209043 € 3,90	209043 € 3,90	209043 € 3,90	209043 € 3,90

Royal

Montatura circolare e portalampe in metallo cromato. Pendagli con elementi in cristallo molato ottagonali, quadrati, rettangolari e gocce finali.

LED Lampadine LED G9 3W 3000 K incluse.
Cod. **209043**

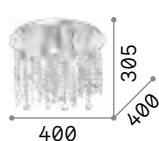
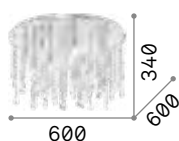

5,900 Kg / 0,0881 m³
G9 max 12 x 40W

2,840 Kg / 0,0379 m³
G9 max 8 x 40W

€ 590

€ 310

053004 Cromo

052991 Cromo

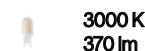

209043 € 3,90

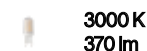

209043 € 3,90



Bijoux

Montatura circolare e portalampe in metallo cromato. Elementi decorativi con catene di ottagoni e pendagli finali a sfera in cristallo molato.

LED Lampadine LED G9 3W 3000 K incluse.
Cod. **209043**

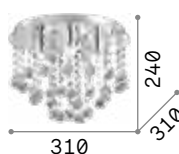

2,370 Kg / 0,0181 m³
G9 max 5 x 40W

€ 218

089485 Cromo

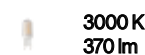

209043 € 3,90





Rain

Montatura in metallo cromato.
Pendagli con elementi in cristallo
molato in varie forme e gocce finali.

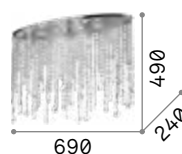

■  IP20

3,820 Kg / 0,0225 m³
E14 max 5 x 40W

€ 340

008455 ■ Cromo

 3000 K
470 lm

101224 € 3,00

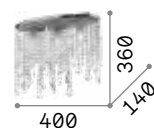

■  IP20

1,800 Kg / 0,0094 m³
E14 max 3 x 40W

€ 170

008370 ■ Cromo

 3000 K
470 lm

101224 € 3,00



P. 199



P. 482



Magnolia

Montatura in metallo con finitura oro. Elementi decorativi in cristallo molato trasparente. Nella parte superiore si alternano elementi trasparenti ed elementi fumè.

LED

Lampadine LED G9 3W 3000 K incluse.
Cod. **209043**



9,780 Kg / 0,0984 m³
G9 max 7 x 15W

€ 620

241296 ■ Oro

3000 K
370 lm
209043 **€ 3,90**

Dubai

Montatura in metallo con finitura cromo o ottone. Elementi decorativi con perle, ottagoni e prismi in cristallo molato trasparente.

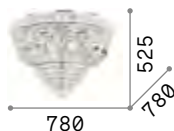

IP20

14,290 Kg / 0,3881 m³
E14 max 24 x 40W

€ 1430

243566 Cromo
243498 Ottone

3000 K
470 lm

101224 € 3,00

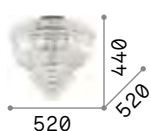

IP20

6,310 Kg / 0,1413 m³
E14 max 6 x 40W

€ 950

207186 Cromo
201016 Ottone

3000 K
470 lm

101224 € 3,00

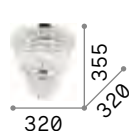

IP20

3,010 Kg / 0,0392 m³
E14 max 3 x 40W

€ 475

207162 Cromo
200996 Ottone

3000 K
470 lm

101224 € 3,00



P. 208



P. 433



207186



201016

Caesar

Montatura in metallo con finitura in oro o cromo. Elementi decorativi in cristallo molato ottagonali con finali a puntale.

LED Lampadine LED G9 3W 3000 K incluse.
Cod. 209043

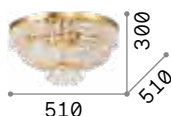

IP20

5,920 Kg / 0,0975 m³
G9 max 6 x 40W

€ 810

093475 Cromo
114682 Ottone

3000 K
370 lm

209043 € 3,90

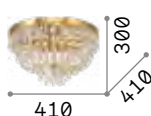

IP20

3,820 Kg / 0,0632 m³
G9 max 5 x 40W

€ 655

103792 Cromo
114675 Ottone

3000 K
370 lm

209043 € 3,90



P. 209



093475



114682



Martinez

Montatura in metallo cromato o dorato. Elementi decorativi con catene di ottagoni e barre in cristallo molato trasparente.



166285



213569



IP20

17,500 Kg / 0,0807 m³
E14 max 8 x 40W

€ 770

166285 Cromo
213569 Oro

3000 K
470 lm

101224 € 3,00



P. 201



Carlton

Montatura in metallo cromato o dorato. Elementi decorativi con catene di ottagononi e barre in cristallo molato trasparente.



168937



213507

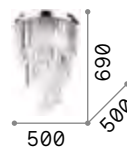

IP20

13,840 Kg / 0,1563 m³
E14 max 12 x 40W

€ 725

168937 Cromo
213507 Oro

3000 K
470 lm

101224 € 3,00

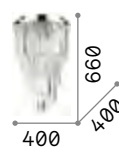

IP20

10,200 Kg / 0,1066 m³
E14 max 8 x 40W

€ 625

168920 Cromo

3000 K
470 lm

101224 € 3,00



Interni

Lampade da parete

Indice alfabetico

Alfa	407	Equinoxe	417	Mirror-10	389	Riflesso	385
Ali	377	Essence	382	Mirror-20	391	Roma	432
Alma	386	Filo	352	Moris	356	Rudy	405
Barber	406	Fiocco	442	Mouse	404	Santa	441
Bean	396	Firenze	438	Negresco	436	Set Up	424
Birds	413	Fix	356	Newton	418	Sheraton	430
Bonjour	387	Flash	369	Ninfea	421	Shower	419
Book	403	Flash Gesso	369	Nordik	428	Sky	370
Bow	388	Florian	436	Oby	406	Slem	407
Box	357	Focus	392	Opera	434	Smarties	375
Bright	362	Frida	411	Ovalino	372	Soda	373
Calypso	432	Gea	431	Oz	350	Spot	404
Camerino	380	Gim	405	Page	397	Strauss	437
Cantina	418	Gioconda	437	Pan	420	Sunrise	421
Carlton	433	Goose	394	Pash à	432	Swan	434
Carrara	443	Harem	440	Paul	372	Syntesi	353
Chalet	438	Hilton	426	Pegaso	435	Tick	422
Click	361	Holiday	430	Peggy	355	Triplo	376
Clip	359	Hotel	429	Perlage	415	Triumph	416
Corte	435	Igor	412	Peter	439	Tudor	379
Cover	354	Io	393	Piano	400	Virtus	361
Craft	364	Kepler	414	Pipe	398	Winery	408
Cube	360	Komodo	401	Posta	358	Woody	427
Delta	363	Kool	368	Pouche	355	Zig Zag	367
Denis	378	Linus	365	Pretty	381		
Desk	364	Lite	399	Privè	384		
Double	391	Look	371	Probe	402		
Dubai	433	Luxury	428	Puzzle	357		
Dynamo	395	Make Up	385	Radio	409		
Echo	366	Mapa Bianco	374	Read	402		
Eclissi	423	Maracas	416	Reflex	360		
Edison	408	Minimal	410	Retrò	390		

Delta

Pag 363



new



Oz 350

new



Filo 352



Box 357



Posta 358



Desk 364

new



Craft 364



Look 371



Paul 372



Tudor 379



Camerino 380



Bow 388



Mirror-10 389



Bean 396



Page 397







































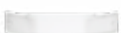

















Mouse 404



Spot 404







































Interni

Indice icone

						
Syntesi 353	Cover 354	Peggy 355	Pouche 355	Fix 356	Moris 356	Puzzle 357
		<small>new</small> 				<small>new</small> 
Clip 359	Cube 360	Reflex 360	Virtus 361	Click 361	Bright 362	Delta 363
		<small>new</small> 				
Linus 365	Echo 366	Zig Zag 367	Kool 368	Flash 369	FlashGesso 369	Sky 370
						
Ovalino 372	Soda 373	MapaBianco 374	Smarties 375	Triplo 376	Ali 377	Denis 378
<small>new</small> 		<small>new</small> 	<small>new</small> 			
Pretty 381	Essence 382	Privè 384	Make Up 385	Riflesso 385	Alma 386	Bonjour 387
						
Retrò 390	Mirror-20 391	Double 391	Focus 392	IO 393	Goose 394	Dynamo 395
		<small>new</small> 	<small>new</small> 			
Pipe 398	Lite 399	Piano 400	Komodo 401	Probe 402	Read 402	Book 403
						
Gim 405	Rudy 405	Oby 406	Barber 406	Alfa 407	Slem 407	Winery 408

Interni

Indice icone

						
Edison 408	Radio 409	Minimal 410	Frida 411	Igor 412	Birds 413	Kepler 414
						
Maracas 416	Equinoxe 417	Cantina 418	Newton 418	Shower 419	Pan 420	Sunrise 421
						
Eclissi 423	Set Up 424	Hilton 426	Woody 427	Luxury 428	Nordik 428	Hotel 429
						
Gea 431	Calypso 432	Roma 432	Pashà 432	Carlton 433	Dubai 433	Opera 434
						
Corte 435	Negresco 436	Florian 436	Gioconda 437	Strauss 437	Firenze 438	Chalet 438
						
Santa 441	Fiocco 442	Carrara 443				

new



Perlage 415



Triumph 416

new



Ninfea 421



Tick 422



Holiday 430



Sheraton 430



Swan 434



Pegaso 435



Peter 439



Harem 440

Ninfea

Pag 421





Oz **new**

Base e montatura in metallo verniciato a polveri o placcato. Diffusore in gomma opale. Disponibile nelle finiture bianco, nero o ottone spazzolato. Disponibile anche in versione dimmerabile DALI/Push.

LED Sorgente luminosa LED 3000 K, 30.000 h di durata.

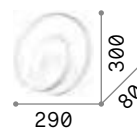

IP20

1,140 Kg / 0,0248 m³
LED 28W / 2500 lm

€ 190 On-Off / 255 Dali

253695	Bianco	On-Off
304489	Bianco	Dali/Push ^{new}
269399	Nero	On-Off
304496	Nero	Dali/Push ^{new}
269405	Ottone	On-Off
304502	Ottone	Dali/Push ^{new}



Filo **new**

Rosone, corpo luce e base a terra in metallo verniciato a polveri o placcato. Diffusore in PC opale satinato. Cavo di sostegno in PVC nero. Alimentato dalla base a terra da cavo nero in PVC con spina. Finiture: bianco, nero oppure ottone.



LED Sorgente luminosa LED 3000 K, 20.000 h di durata.

ON OFF Lampada con interruttore integrato.



P. 078

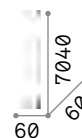

■ □ IP20

1,200 Kg / 0,0124 m³
LED 15W / 1600 lm

€ 285

301051 ■ Bianco **new**
301068 ■ Nero **new**
301075 ■ Ottone **new**



Syntesi

Struttura e corpo luce in alluminio verniciato a polveri. Diffusore orientabile con schermo in acrilico trasparente zigrinato. Colore: bianco o nero.

LED Sorgente luminosa LED 3000 K, 30.000 h di durata.



285269

271880

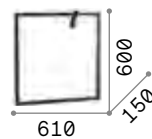

■ □ IP20

1,140 Kg / 0,0696 m³
LED 5W / 350 lm

€ 525

285276 □ Bianco
271897 ■ Nero



■ □ IP20

0,200 Kg / 0,0047 m³
LED 3W / 350 lm

€ 330

285269 □ Bianco
271880 ■ Nero



Cover

Corpo luce in alluminio verniciato a polveri di colore bianco o nero. Diffusore in materiale plastico opale. Sorgente luminosa a led integrati con emissione di luce riflessa.

LED

Sorgente luminosa LED 3000 K, 30.000 h di durata.

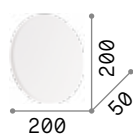

0,690 Kg / 0,0028 m³
LED 11W / 1000 lm

€ 100

195711 Bianco
195759 Nero

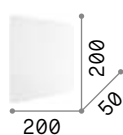

0,860 Kg / 0,0028 m³
LED 11W / 1000 lm

€ 100

195735 Bianco
195773 Nero

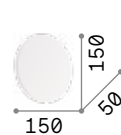

0,390 Kg / 0,0018 m³
LED 9,5W / 830 lm

€ 88

195704 Bianco
195742 Nero

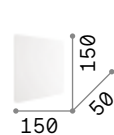

0,510 Kg / 0,0018 m³
LED 9,5W / 830 lm

€ 88

195728 Bianco
195766 Nero

Peggy

Base e montatura in metallo verniciato a polveri con finitura bianca. Diffusore in acrilico satinato. Emissione luce indiretta.

LED Sorgente luminosa LED 3000 K, 50.000 h di durata.

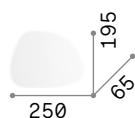

■ IP20

0,710 Kg / 0,0068 m³
LED 16,5W / 1500 Lm

€ 170

257242 Bianco

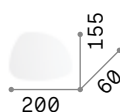

■ IP20

0,520 Kg / 0,0030 m³
LED 10,5W / 1080 Lm

€ 110

257235 Bianco



Pouche

Montatura in metallo rifinito con vernice a polveri di colore bianco. Diffusore in acrilico trasparente satinato. Emissione luce indiretta.

LED Sorgente luminosa LED 3000 K, 20.000 h di durata.

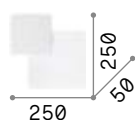

■ IP20

1,440 Kg / 0,0067 m³
LED 14W / 1300 Lm

€ 110

259352 Bianco



■ IP20

1,120 Kg / 0,0067 m³
LED 14W / 1300 Lm

€ 110

259345 Bianco



Fix

Base in metallo con finitura bianca opaca. Diffusore-dissipatore in lastra d'alluminio da 6 mm di spessore. LED integrati.

LED Sorgente luminosa LED 3000 K, 20.000 h di durata.

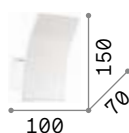

■ □ IP20

0,390 Kg / 0,0050 m³

LED 5,5W / 440 lm

€ 95

117867 Bianco



Moris

Montatura in metallo cromato.
Diffusore in vetro soffiato bianco.

LED Lampadine LED G9 3W 3000 K incluse.
Cod. 209043



■ ⊕ IP20

0,520 Kg / 0,0071 m³

G9 max 2x 40W

€ 90

034546 Bianco

3000 K
370 lm

209043 € 3,90



Puzzle

Montatura in metallo con finitura cromo. Diffusore in vetro soffiato bianco, incamiciato e acidato.

LED Lampadine LED G9 3W 3000 K incluse.
Cod. **209043**

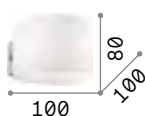

0,520 Kg / 0,0061 m³

G9 max 1x 40W

€ 58

035185 **Bianco**

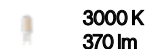

209043 € 3,90



Box

Montatura in metallo cromato.
Diffusore in vetro soffiato, incamiciato e acidato. Bianco all'interno e colorato all'esterno.

LED Lampadine LED G9 3W 3000 K incluse.
Cod. **209043**

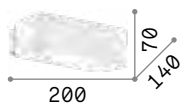

0,660 Kg / 0,0100 m³

G9 max 2 x 40W

€ 80

009537 **Bianco**

009513 **Nero**

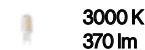

209043 € 3,90



009537

009513

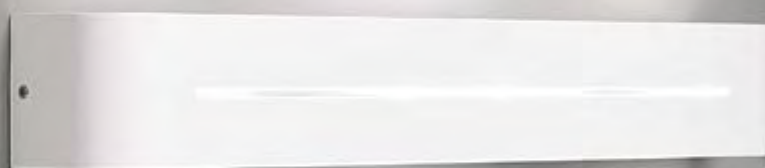







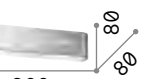

051963

009940

Posta

Corpo luce in metallo disponibile in alluminio spazzolato o smaltato bianco. Diffusore composto di tre vetri trasparenti smerigliati.

		
620	500	360
■  IP20	■  IP20	■  IP20
1,560 Kg / 0,0156 m ³ E14 max 4 x 40W	1,270 Kg / 0,0136 m ³ E14 max 3 x 40W	0,950 Kg / 0,0098 m ³ E14 max 2 x 40W
€ 95	€ 87	€ 75
051987 Bianco 009957 Alluminio	051970 Bianco 009933 Alluminio	051963 Bianco 009940 Alluminio
 3000 K 480 lm	 3000 K 480 lm	 3000 K 480 lm
101200 € 3,00	101200 € 3,00	101200 € 3,00



Clip

Corpo luce interamente in lamina di metallo con varie finiture. Nella versione piccola, diffusori in vetro pirex sabbato.

LED

Lampadine LED G9 3W 3000 K incluse nei modelli: **049236, 091136, 049229, 091129 e 170923**. Cod. **209043**

	014166		
	088273		
	031361		
	088266	1,210 Kg / 0,0161 m³ E27 max 2 x 60W	0,730 Kg / 0,0035 m³ G9 max 2 x 40W
	187365	€ 107	€ 95
		014166 Bianco	049236 Bianco
		088273 Argento	091136 Argento
		031361 Cromo	049229 Cromo
		088266 Oro	091129 Oro
		187365 Corten	170923 Corten
		3000 K 430 lm	3000 K 370 lm
		101279 € 3,00	209043 € 3,90

Cube

Corpoluce dissipatore interamente in lastra d'alluminio da 6 mm di spessore. Rifinito con vernice a polveri. LED integrati.

LED Sorgente luminosa LED 3000 K, 30.000 h di durata.

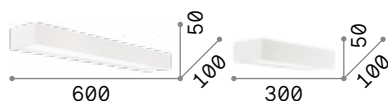

■ IP20

1,390 Kg / 0,0055 m³
LED 14,5W / 1900 lm

€ 195

161792 Bianco

■ IP20

0,800 Kg / 0,0028 m³
LED 8W / 950 lm

€ 145

161785 Bianco



Reflex ^{new}

Corpo luce in alluminio verniciato a polveri. Diffusori in policarbonato opale satinato. Emissione luce sopra e sotto. Finiture: bianco.

LED Sorgente luminosa LED 3000 K, 30.000 h di durata.

IP44 Grado di protezione IP44.

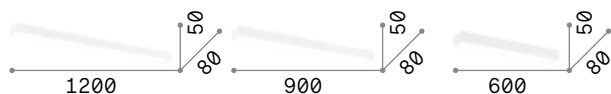

■ IP44

2,000 Kg / 0,0075 m³
LED 30W / 3900 lm

€ 285

277868 Bianco

■ IP44

1,900 Kg / 0,0057 m³
LED 23W / 2900 lm

€ 225

new 277851 Bianco

■ IP44

1,300 Kg / 0,0038 m³
LED 18W / 2200 lm

€ 175

new 277844 Bianco new



Virtus

Montatura in metallo verniciato a polveri. Diffusore in acrilico satinato. Emissione luminosa diffusa, sopra, sotto e frontale. Colore: bianco.

LED Sorgente luminosa LED 3000/4000 K, 15.000 h di durata.

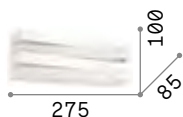

IP20

0,980 Kg / 0,0035 m³

LED 13W / 800/850 Lm

€ 115

267760 Bianco 3000K

255989 Bianco 4000K



Click

Corpo luce interamente in alluminio verniciato a polveri con finitura bianca. Struttura interna che riflette il fascio luminoso sia sopra che sotto.

LED Sorgente luminosa LED 3000 K, 20.000 h di durata.

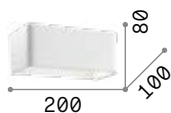

IP20

0,600 Kg / 0,0040 m³
LED 10,5W / 1050 lm

€ 84

017518 Bianco

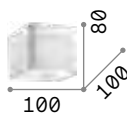

IP20

0,400 Kg / 0,0019 m³
LED 5,5W / 500 lm

€ 62

051444 Bianco





Bright

Corpo luce interamente in alluminio con finitura bianca. Fascio luminoso orientato sia verso l'alto che verso il basso.

LED

Sorgente luminosa LED 3000 K, 30.000 h di durata.

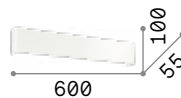

■ □ IP20

1,660 Kg / 0,0101 m³
LED 23W / 1650 lm

€ 215

131962 Bianco

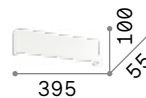

■ □ IP20

1,120 Kg / 0,0064 m³
LED 15,5W / 1100 lm

€ 160

134789 Bianco

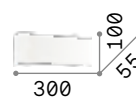

■ □ IP20

0,930 Kg / 0,0051 m³
LED 11W / 820 lm

€ 125

134796 Bianco



Delta **new**

Corpoluce in alluminio verniciato a polveri. Diffusori in policarbonato opale lucido. Emissione luce sopra e sotto. Finiture: bianco oppure nero.

LED Sorgente luminosa LED 3000/4000 K, 50.000 h di durata.

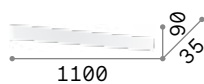

■ \oplus IP20

2,400 Kg / 0,0104 m³
LED 37W / 4550/4800 lm

€ 230

287607 Bianco 3000K **new**
307053 Bianco 4000K **new**
287591 Nero 3000K **new**
307060 Nero 4000K **new**

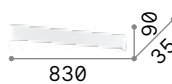

■ \oplus IP20

0,900 Kg / 0,0079 m³
LED 30W / 3600/3800 lm

€ 200

287621 Bianco 3000K **new**
307039 Bianco 4000K **new**
287614 Nero 3000K **new**
307046 Nero 4000K **new**

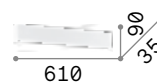

■ \oplus IP20

0,950 Kg / 0,0059 m³
LED 19,5W / 2050/2150 lm

€ 140

287645 Bianco 3000K **new**
307015 Bianco 4000K **new**
287638 Nero 3000K **new**
307022 Nero 4000K **new**



287645



287638

Desk

Corpo luce in alluminio verniciato a polveri con finitura bianca o nera. Diffusori in acrilico satinato. Emissione luce sopra e sotto.

LED Sorgente luminosa LED 3000 K, 30.000 h di durata.



■ IP20

0,640 Kg / 0,0045 m³

LED 12,5W / 740 lm

€ 145

138251 ■ Bianco

173252 ■ Nero



P. 082



Craft ^{new}

Base in metallo verniciato nero opaco. Corpo luce in legno naturale. Diffusore in policarbonato opale satinato. Emissione luce verso il basso.

LED Sorgente luminosa LED 3000 K, 20.000 h di durata.

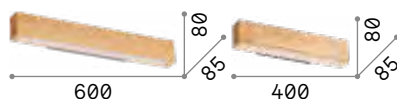

■ IP20

1,000 Kg / 0,0083 m³

LED 20W / 1900 lm

€ 210

284491 ■ Legno

■ IP20

0,800 Kg / 0,0057 m³

LED 13W / 1100 lm

€ 145

^{new} 284477 ■ Legno ^{new}



P. 083



P. 502

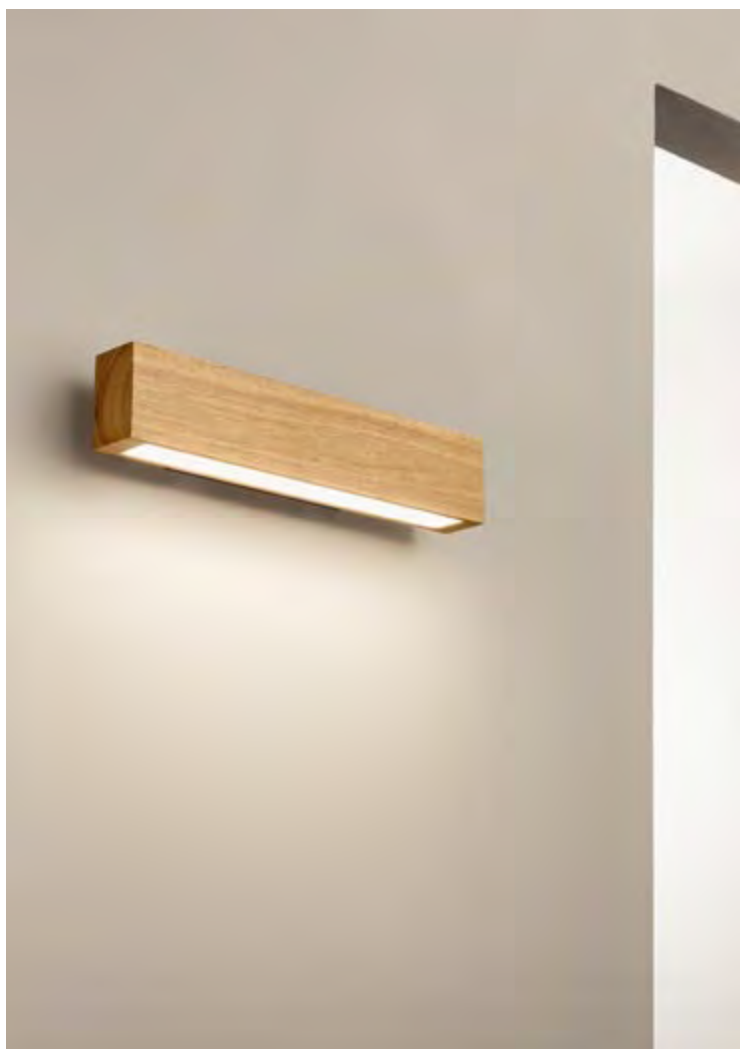



Linus

Lampada lineare in alluminio con illuminazione diretta e indiretta per applicazione a parete. La lampada è modulare e può essere proposta singolarmente oppure in linea continua. È disponibile in finitura bianca o nera. LED integrati; binning iniziale \leq 3-Step MacAdam; disponibile in temperatura di colore 3000 K e 4000 K; CRI \geq 80. Alimentatore dimmerabile 1-10V integrato di serie.

LED Sorgente luminosa LED 3000/4000 K, 50.000 h di durata.

+ Lampada con dimmer.



P. 572

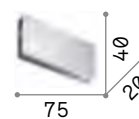

1,250 Kg / 0,0158 m³
LED 32W / 3450/3600 lm

€ 210

233840	Bianco	3000K
268095	Bianco	4000K
242019	Nero	3000K
268071	Nero	4000K

Connector
Non incluso
Optional

€ 6

233666



273914

285283

285290

Echo

Base e diffusore interamente in alluminio verniciato a polveri o placcato. Emissione luce indiretta. Colori: bianco, nero, ottone satinato.

LED Sorgente luminosa LED 3000 K, 50.000 h di durata.

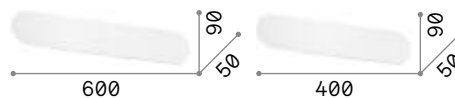

■ IP20

0,930 Kg / 0,0051 m³
LED 30W / 3850 lm

€ 160

273945 Bianco
285306 Nero
285313 Ottone

■ IP20

0,640 Kg / 0,0032 m³
LED 20W / 2250 lm

€ 140

273914 Bianco
285283 Nero
285290 Ottone



Zig Zag

Corpo luce dissipatore interamente in lastra d'alluminio da 6 mm di spessore. Rifinito con vernice a polveri di colore bianco, nero o placcato ottone, cromo oppure rame. LED integrati.

LED Sorgente luminosa LED 3000/4000 K, 50.000 h di durata.



■ IP20

1,040 Kg / 0,0053 m³
LED 30W / 4100/4300 lm

€ 135

277219	Bianco	3000K
277257	Bianco	4000K
307183	Cromo	3000K <i>new</i>
277226	Nero	3000K
287072	Ottone	3000K
307190	Rame	3000K <i>new</i>

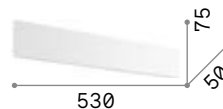

■ IP20

0,590 Kg / 0,0029 m³
LED 23W / 2900/3050 lm

€ 103

179308	Bianco	3000K
277240	Bianco	4000K
282152	Cromo	3000K <i>new</i>
179322	Nero	3000K
282138	Ottone	3000K
282176	Rame	3000K <i>new</i>

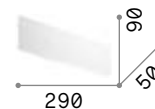

■ IP20

0,450 Kg / 0,0020 m³
LED 12,5W / 1450/1550 lm

€ 90

179292	Bianco	3000K
277233	Bianco	4000K
282145	Cromo	3000K <i>new</i>
179315	Nero	3000K
282121	Ottone	3000K
282169	Rame	3000K <i>new</i>



Kool

Corpo luce in vero cemento.
Supporto di fissaggio in metallo non visibile. Emette luce sopra e sotto.

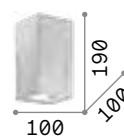

■ □ IP20

1,260 Kg / 0,0060 m³
GU10 max 2 x 15W

€ 98

141275 ■ Cemento

3000 K
440 lm

108292 € 4,50

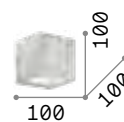

■ □ IP20

0,700 Kg / 0,0036 m³
G9 max 1 x 15W

€ 66

141268 ■ Cemento

3000 K
370 lm

209043 € 3,90

Flash

Montatura in metallo rifinito in vernice opaca di colore bianco. Emette luce sopra e sotto.

LED Lampadine LED G9 3W 3000 K incluse.
Cod. 209043



0,360 Kg / 0,0012 m³
G9 max 2x 40W

€ 62

095288 Bianco

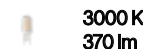

209043 € 3,90

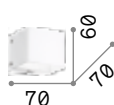

0,200 Kg / 0,0005 m³
G9 max 1x 40W

€ 34

095264 Bianco

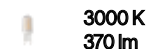

209043 € 3,90



Flash Gesso

Base in metallo smaltato. Corpo luce interamente in gesso. Doppia emissione luminosa: sopra e sotto.

Articolo adatto alla pittura e verniciatura.

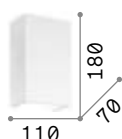

0,710 Kg / 0,0049 m³
G9 max 1x 40W

€ 51

214689 Bianco

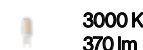

209043 € 3,90

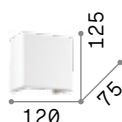

0,770 Kg / 0,0024 m³
G9 max 1x 40W

€ 49

214672 Bianco

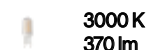

209043 € 3,90

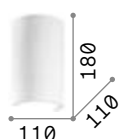

0,950 Kg / 0,0034 m³
G9 max 1x 40W

€ 45

214696 Bianco

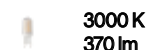

209043 € 3,90

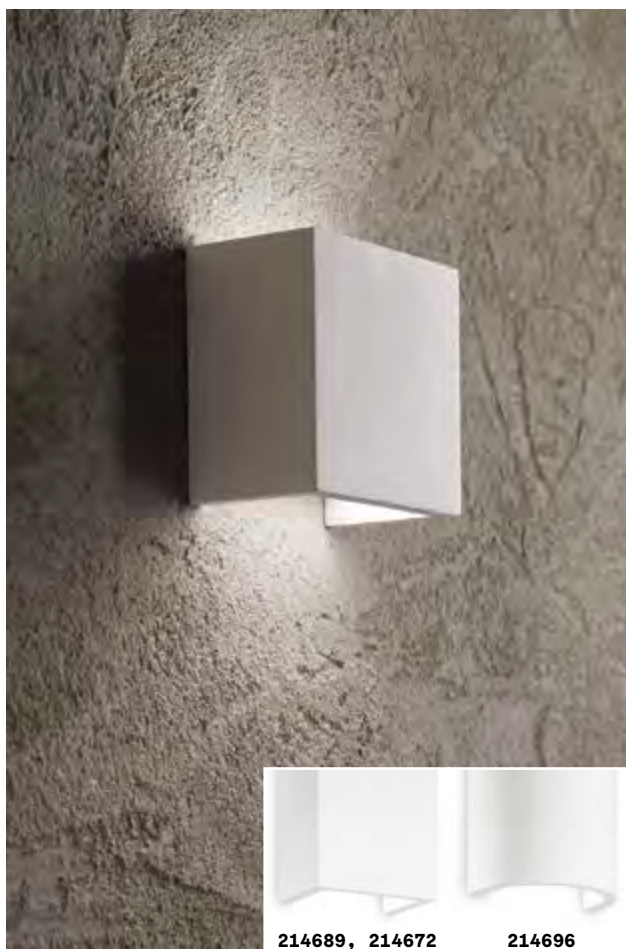



Sky

Base e diffusore in metallo placcato o verniciato opaco o decorato in foglia d'oro o d'argento.



Lampadine LED GU10 7W 3000 K incluse. Cod. **123943**



126883

136905

136882

126890

136899

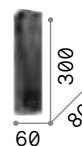

0,940 Kg / 0,0049 m³
GU10 max 2x28W

€ 116

126883 Bianco
136905 Cromo
136882 Argento
126890 Nero
136899 Oro

3000 K
610 lm

123943 **€ 4,50**



P. 077 P. 299



Look

Corpo luce in metallo con finitura rame, cromo, brunito o vernice opaca di colore bianco o nero.

LED Lampadine LED GU10 7W 3000 KK
includ. Cod. **123943**



096018

094182

095998

164847

164823



0,500 Kg / 0,0028 m³
GU10 max 2x 28W

€ 80

096018 Bianco
094182 Cromo
095998 Nero
164847 Rame
164823 Brunito

3000 K
610 lm

123943

€ 4,50



P. 074



P. 298



P. 641

Paul

Base in metallo rifinito con vernice opaca. Diffusore in vetro soffiato, incamiciato e acidato. Disponibile con finitura bianca.

LED Lampadine LED G9 3W 3000 K incluse.
Cod. **209043**

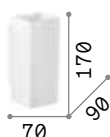
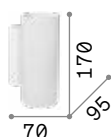

0,560 Kg / 0,0064 m³
G9 max 2 x 40W

0,540 Kg / 0,0056 m³
G9 max 2 x 40W

€ 65

€ 65

060620 Bianco

231129 Bianco

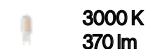
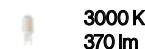

209043 € 3,90

209043 € 3,90

Ovalino

Diffusore composto da elementi circolari in lastra di vetro curvata e acidata.

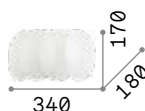

1,800 Kg / 0,0563 m³
E27 max 2 x 60W

€ 125

038025 Bianco

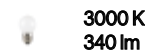

101286 € 3,00

P. 172 P. 286



Soda

Corpo luce in gesso bianco. Base in metallo smaltato bianco. Diffusore inferiore in vetro trasparente satinato. Emissione luce sia sopra che sotto.



Articolo adatto alla pittura e verniciatura.

510	300
2,630 Kg / 0,0154 m ³	1,100 Kg / 0,0068 m ³
E14 max 2x 40W	E14 max 1x 40W
€ 100	€ 65
105727 Bianco	105710 Bianco
3000 K 420 lm	3000 K 420 lm
101217 € 3,00	101217 € 3,00



Mapa Bianco

Base e sistema di fissaggio in metallo bianco. Diffusore a sfera in vetro bianco soffiato e acidato.

LED Lampadine LED G9 3W 3000 K incluse nel modello **059808**. Cod. **209043**

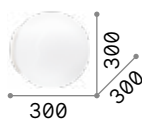

IP20

1,660 Kg / 0,0647 m³
E27 max 1x60W

€ 88

059822 Bianco

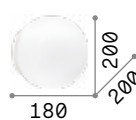

IP20

0,900 Kg / 0,0259 m³
E27 max 1x60W

€ 50

059815 Bianco

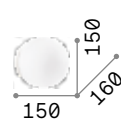



IP20 INCLUSA

0,380 Kg / 0,0115 m³
G9 max 1x15W

€ 44

059808 Bianco

 3000 K
430 lm
101279 € 3,00

 3000 K
430 lm
101279 € 3,00

 3000 K
370 lm
209043 € 3,90

  
P. 162 P. 284 P. 461



Smarties

Base in metallo. Diffusore in vetro soffiato bianco acidato con sistema di fissaggio senza viti.



Lampadine LED G9 3W 3000 K incluse.
Cod. **209043**

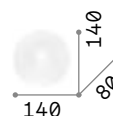

0,440 Kg / 0,0079 m³
G9 max 1x 15W

€ 46

014814 Bianco

3000 K
370 lm

209043 € 3,90



P. 152



P. 283



P. 460



Triplo

Diffusore con triplo vetro, uno trasparente e piano alla base e due smerigliati ad acido e ricurvi sulla parte superiore. Elementi ferma vetro in metallo cromato.

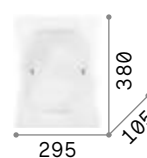

■  IP20

2,170 Kg / 0,0283 m³
E27 max 2 x 60W

€ 70

026480 Bianco

 3000 K
340 lm

101286 € 3,00

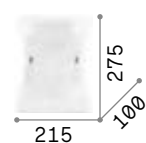

■  IP20

1,260 Kg / 0,0141 m³
E27 max 1 x 60W

€ 48

026473 Bianco

 3000 K
340 lm

101286 € 3,00



Ali

Diffusore in vetro bianco acidato
composto da tre elementi: due
laterali e uno frontale. Viti
fermavetro cromate.



IP20

1,410 Kg / 0,0204 m³
E27 max 2x 60W

€ 57

026558 Bianco

3000 K
340 lm

101286 € 3,00



Denis

Diffusore con triplo vetro. Due laterali in vetro trasparente acidato e uno frontale trasparente con decorazione bianca centrale serigrafata.

LED Lampadine LED R7s 13W 118 mm
3000 K incluse. Cod. **189093**

460	350
1,070 Kg / 0,0169 m ³ R7s max 1x 100W	0,820 Kg / 0,0132 m ³ R7s max 1x 100W
€ 72	€ 61
005454 Bianco	005294 Bianco
3000 K 760 lm	3000 K 760 lm
189093 € 18,50	189093 € 18,50



Tudor

Base in metallo cromato. Diffusore composto da cornice in vetro trasparente molato e mezzo tubo in vetro pirex sabbato nella parte centrale.

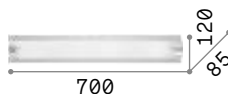

■  IP20

1,900 Kg / 0,0214 m³
E14 max 4 x 40W

€ 100

051864 Trasparen.

 3000 K
420 lm

101217 € 3,00

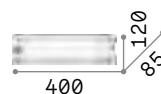

■  IP20

1,130 Kg / 0,0088 m³
E14 max 2 x 40W

€ 70

051857 Trasparen.

 3000 K
420 lm

101217 € 3,00

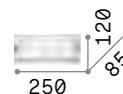

■  IP20

0,700 Kg / 0,0077 m³
E14 max 1 x 40W

€ 50

051840 Trasparen.

 3000 K
420 lm

101217 € 3,00



Camerino

Base in alluminio. Diffusore in vetro bianco soffiato e acidato, chiuso alle estremità da dischi in materiale acrilico trasparente.

650	520	370
1,170 Kg / 0,0157 m³	0,960 Kg / 0,0123 m³	0,780 Kg / 0,0097 m³
E14 max 4 x 40W	E14 max 3 x 40W	E14 max 2 x 40W
€ 98	€ 88	€ 78
027104 Bianco	027098 Bianco	027081 Bianco
3000 K 420 lm	3000 K 420 lm	3000 K 420 lm
101217 € 3,00	101217 € 3,00	101217 € 3,00



Pretty ^{new}

Base ed elementi laterali
in alluminio verniciato a
polveri. Diffusore cilindrico
in policarbonato opale lucido.
Finitura: bianco.

LED Sorgente luminosa LED 3000 K,
50.000 h di durata.

IP54 Grado di protezione IP54.

1070	807	605
■ IP54	■ IP54	■ IP54
1,250 Kg / 0,0169 m ³ LED 24W / 2750 lm	1,120 Kg / 0,0137 m ³ LED 17W / 2200 lm	0,960 Kg / 0,0105 m ³ LED 11,5W / 1250 lm
€ 185	€ 155	€ 125
287768 Bianco ^{new}	287775 Bianco ^{new}	287782 Bianco ^{new}



Essence

Base e corpo luce in alluminio verniciato a polveri. Diffusore in materiale acrilico opale. Emissione luce indiretta. Colori: bianco o nero.

LED Sorgente luminosa LED 3000 K, 30.000 h di durata.



285115



285108

1,200 Kg / 0,0346 m ³ LED 20W / 2650 lm	0,800 Kg / 0,0205 m ³ LED 11W / 1650 lm
€ 240	€ 182
265575 Bianco 285108 Nero	285115 Bianco 265643 Nero





Privè

Corpo luce interamente in metallo con varie finiture. L'assenza di diffusore consente di montare una vasta gamma di lampade con attacco E14.

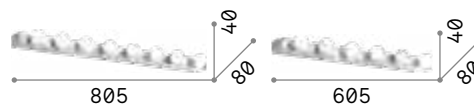
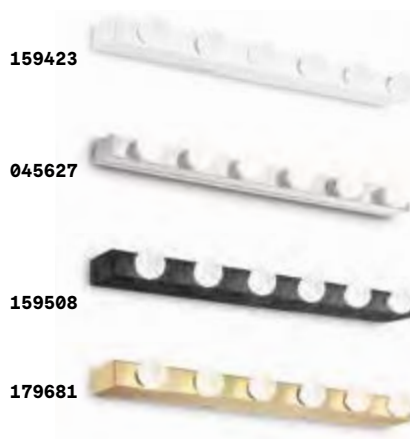

■  IP20

1,420 Kg / 0,0143 m³
E14 max 8 x 40W

€ 128

159522 ■ Bianco
045634 ■ Cromo

 3000 K
420 lm

101217 € 3,00

■  IP20

1,100 Kg / 0,0095 m³
E14 max 6 x 40W

€ 100

159423 ■ Bianco
045627 ■ Cromo
159508 ■ Nero
179681 ■ Ottone

 3000 K
420 lm

101217 € 3,00

Make Up ^{new}

Base e corpo luce in alluminio verniciato a polveri. Diffusore in acrilico trasparente satinato. Emissione luce in basso. Finiture: bianco.

LED Sorgente luminosa LED 3000 K, 50.000 h di durata.

IP54 Grado di protezione IP54.

■ IP54	■ IP54	■ IP54
1,400 Kg / 0,0111 m³ LED 27W / 3400 lm	1,200 Kg / 0,0075 m³ LED 18W / 2300 lm	1,000 Kg / 0,0058 m³ LED 12W / 1250 lm
€ 250	€ 185	€ 150
287676 ■ Bianco ^{new}	287669 ■ Bianco ^{new}	287652 ■ Bianco ^{new}



Riflesso

Montatura in metallo rifinito in cromo o vernice bianca opaca. Diffusore in materiale acrilico trasparente e satinato.

LED Sorgente luminosa LED 3000 K, 30.000 h di durata.

IP44 Grado di protezione IP44.

■ IP44	■ IP44
0,750 Kg / 0,0192 m³ LED 18W / 1350 lm	0,600 Kg / 0,0143 m³ LED 11W / 900 lm
€ 190	€ 155
142289 ■ Bianco 142265 ■ Cromo	142296 ■ Bianco 142272 ■ Cromo



142296

142272



Alma

Corpo luce in metallo rifinito ottone satinato, cromo o con vernice a polveri bianco. Diffusore fisso in materiale plastico colore opale.

LED Sorgente luminosa LED 3000 K, 30.000 h di durata.



224985

224930

224954



■ □ IP20

0,660 Kg / 0,0264 m³
LED 18W / 2250 lm

€ 165

225029 □ Bianco
224992 ■ Cromo
225005 ■ Ottone

■ □ IP20

0,650 Kg / 0,0162 m³
LED 12,5W / 1450 lm

€ 125

224985 □ Bianco
224930 ■ Cromo
224954 ■ Ottone



Bonjour

Montatura in metallo o bianco.
Diffusore inclinabile con schermo in
materiale plastico. Led integrato.

LED Sorgente luminosa LED 3000 K,
20.000 h di durata.



199870

199894

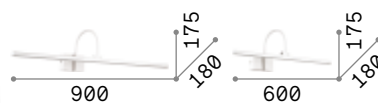

900

■ □ IP20

0,530 Kg / 0,0407 m³
LED 13W / 1250 lm

€ 210

199931 ■ Bianco
199917 ■ Cromo

■ □ IP20

0,480 Kg / 0,0265 m³
LED 9,5W / 950 lm

€ 175

199894 ■ Bianco
199870 ■ Cromo



Bow

Montatura in metallo con finitura disponibile in brunito, cromo o ottone satinato. Diffusore a LED inclinabile. Interruttore sulla base.

LED Sorgente luminosa LED 3000 K, 20.000 h di durata.

ON OFF Lampada con interruttore integrato.

■ IP20	■ IP20	■ IP20
0,860 Kg / 0,0328 m³ LED 8W / 860 lm	0,790 Kg / 0,0207 m³ LED 4,5W / 450 lm	0,640 Kg / 0,0117 m³ LED 2,5W / 240 lm
€ 195	€ 145	€ 125
007021 ■ Cromo 121130 ■ Ottone 121147 ■ Brunito	007045 ■ Cromo 121178 ■ Ottone 121161 ■ Brunito	005386 ■ Cromo 121154 ■ Ottone 121338 ■ Brunito



Mirror-10

Montatura in metallo con finitura
in brunito, cromo o nickel satinato.
Diffusore posizionabile.

LED Lampadine LED G9 3W 3000 K incluse.
Cod. **209043**

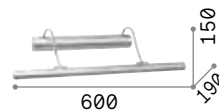

IP20

1,090 Kg / 0,0181 m³
G9 max 4 x 40W

€ 138

017303 Cromo
017297 Nickel
017310 Brunito

3000 K
370 lm
209043 € 3,90



Retrò

Base braccio e diffusore interamente in metallo con finitura brunito. Diffusore orientabile.



■  IP20

0,790 Kg / 0,0152 m³
E14 max 2x28W

€ 120

144917 ■ Brunito

 3000 K
470 lm

101224 € 3,00

Mirror-20

Montatura in metallo con finitura disponibile in brunito, in cromo o in ottone. Diffusore regolabile.

LED Lampadine LED G9 3W 3000 K incluse.
Cod. **209043**



0,550 Kg / 0,0077 m³
G9 max 2 x 40W

€ 94

017334 Cromo
031507 Ottone
017327 Brunito

3000 K
370 lm
209043 € 3,90



017334



031507



017327

Double

Montatura in metallo cromato.
Diffusori in vetro pirex trasparente chiuso alle estremità e smerigliato a sabbia nelle parti centrali.

LED Lampadine LED G9 3W 3000 K incluse.
Cod. **209043**

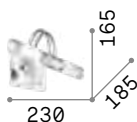

0,530 Kg / 0,0042 m³
G9 max 2 x 40W

€ 69

008851 Cromo

3000 K
370 lm
209043 € 3,90





Focus

Corpo luce in metallo con braccio flessibile orientabile rivestito in gomma. Rifinito in bianco o in nero opaco oppure in grigio con dettagli in cromo.

LED Sorgente luminosa LED 3000 K, 30.000 h di durata.

ON OFF Lampada con interruttore integrato.

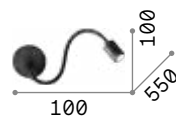

IP20

0,400 Kg / 0,0025 m³
LED 4W / 210 lm

€ 71

097183 ■ Bianco
097206 ■ Cromo
097190 ■ Nero

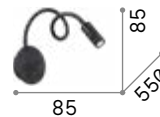

IP20

0,410 Kg / 0,0020 m³
LED 3,5W / 280 lm

€ 75

203171 ■ Bianco
203188 ■ Cromo
203195 ■ Nero



IO

Corpo luce da incasso con montatura in metallo verniciato a polveri. Braccio flessibile rivestito in gomma. Diffusore con schermo acrilico trasparente zigrinato. Interruttore incorporato. Colori: bianco o nero.

LED Sorgente luminosa LED 3000 K, 30.000 h di durata.

ON OFF Lampada con interruttore integrato.



285320



272030

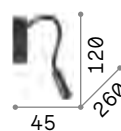

IP20

0,240 Kg / 0,0027 m³
LED 3W / 300 lm

€ 130

285320 ■ Bianco
272030 ■ Nero



Goose

Montatura e diffusore in fusione d'alluminio verniciato a polveri con colori opachi. Braccio flessibile rivestito in gomma siliconica.

LED

Sorgente luminosa LED 3000 K, 30.000 h di durata.

**ON
OFF**

Lampada con interruttore integrato.



142708

142692



IP20

0,430 Kg / 0,0040 m³
LED 3W / 200 lm

€ 145

142708 ■ Bianco
142692 ■ Nero



Dynamo

Montatura e braccio flessibile in metallo con finitura disponibile in cromo, nickel e brunito. Diffusore orientabile a piacere. Dotato di interruttore sulla base.

LED Sorgente luminosa LED 4000 K, 20.000 h di durata.

ON OFF Lampada con interruttore integrato.



031460



031477



121352

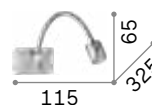

■ IP20

0,500 Kg / 0,0031 m³
LED 3W / 200 lm

€ 88

031460 ■ Cromo
031477 ■ Nickel
121352 ■ Brunito



Bean

Base e diffusore orientabile in metallo placcato o verniciato a polveri. Colori bianco, nero oppure ottone o nickel con interruttore e snodo neri.

LED Sorgente luminosa LED 3000 K, 30.000 h di durata.

ON OFF Lampada con interruttore integrato.



260600



260631



260617



260624

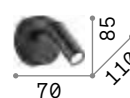
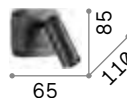

IP20

IP20

0,180 Kg / 0,0008 m³
LED 3W / 280 lm

0,180 Kg / 0,0005 m³
LED 3W / 280 lm

€ 48

€ 48

260648 Bianco
260679 Nickel
260655 Nero
260662 Ottone

260600 Bianco
260631 Nickel
260617 Nero
260624 Ottone



Page

Corpo luce in alluminio verniciato a polveri bianco o nero. Diffusore orientabile con lente e elemento snodato in metallo cromato.

LED Sorgente luminosa LED 3000 K, 30.000 h di durata.

ON OFF Lampada con interruttore integrato.

142586



142579

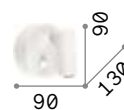

IP20

0,280 Kg / 0,0030 m³
LED 3W / 145 lm

€ 100

142586 ■ Bianco
142579 ■ Nero

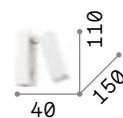

IP20

0,420 Kg / 0,0023 m³
LED 3W / 145 lm

€ 105

142258 ■ Bianco
142241 ■ Nero



Pipe

Corpo luce in alluminio verniciato a polveri. Diffusore orientabile con schermo acrilico zigrinato, fissato con ghiera. Interruttore incorporato. Colori: bianco o nero.

LED Sorgente luminosa LED 3000 K, 20.000 h di durata.

ON OFF Lampada con interruttore integrato.



280998



281001

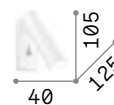

■ □ IP20

0,400 Kg / 0,0009 m³
LED 7W / 580 lm

€ 100

280998 ■ Bianco
281001 ■ Nero



Lite

Base e corpo luce in alluminio con finitura bianco, nero, nickel o ottone. Diffusore orientabile. Interruttore incorporato. Installazione ad incasso su scatola di derivazione tipo 502, non inclusa.

LED Sorgente luminosa LED 3000 K, 20.000 h di durata.

ON/OFF Lampada con interruttore integrato.

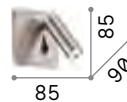

IP20

0,340 Kg / 0,0008 m³
LED 3W / 200 lm

€ 61

250106 Bianco
250137 Nickel
250113 Nero
250120 Ottone



Piano new

Montatura interamente in alluminio verniciato a polveri. Diffusore in policarbonato opale con emissione sul retro. Proiettore frontale orientabile. Colore: bianco o nero.

LED

Sorgente luminosa LED 3000 K, 20.000 h di durata.

**ON
OFF**

Lampada con interruttore integrato.

USB

Lampada con presa USB integrata.

287317



287300

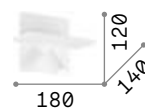

■ □ IP20

0,800 Kg / 0,0068 m³
LED 10W / 730 lm

€ 165

287317 ■ Bianco new
287300 ■ Nero new



Komodo ^{new}

Montatura in metallo verniciato a polveri. Diffusore orientabile. Interruttore e presa USB incorporati. Finiture: bianco oppure nero.

LED Sorgente luminosa LED 3000 K, 20.000 h di durata.

ON/OFF Lampada con interruttore integrato.

USB Lampada con presa USB integrata.

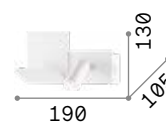
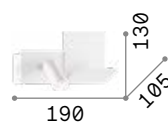

■ □ IP20

0,700 Kg / 0,0060 m³
LED 3,5W / 250 lm

€ 110

■ □ IP20

0,700 Kg / 0,0060 m³
LED 3,5W / 250 lm

€ 110

291789 ■ Bianco ^{new} 306810 ■ Bianco ^{new}
291796 ■ Nero ^{new} 306827 ■ Nero ^{new}

Probe

Corpo luce in alluminio verniciato a polveri bianco o nero. Doppio diffusore: superiore in acrilico e inferiore con braccetto flessibile.

LED Sorgente luminosa LED 3000 K, 20.000 h di durata.

ON OFF Lampada con interruttore integrato.

USB Lampada con presa USB integrata.

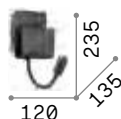

■ IP20

0,870 Kg / 0,0021 m³

LED 9W / 700 lm

€ 150

243160 ■ Bianco

237930 ■ Nero



Read

Montatura metallica verniciata a polveri con finitura bianca o nera. Diffusore orientabile con LED integrato. Presa USB.

LED Sorgente luminosa LED 3000 K, 15.000 h di durata.

ON OFF Lampada con interruttore integrato.

USB Lampada con presa USB integrata.

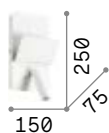

■ IP20

1,060 Kg / 0,0049 m³

LED 3W / 200 lm

€ 150

176536 ■ Bianco

176550 ■ Nero





Book

Montatura metallica verniciata a polveri. Diffusore in vetro satinato. Braccio flessibile gommato con LED. Doppio interruttore. Presa USB.

LED Sorgente luminosa LED 3000 K, 15.000 h di durata.

ON/OFF Lampada con interruttore integrato.

USB Lampada con presa USB integrata.



IP20

1,570 Kg / 0,0125 m³
G9 max 1x 28W +
LED 3W / 200 lm

€ 180

174792 ■ Bianco
174808 ■ Nero

3000 K
370 lm
209043 € 3,90



IP20

1,570 Kg / 0,0125 m³
G9 max 1x 28W +
LED 3W / 200 lm

€ 180

174822 ■ Bianco
174846 ■ Nero

3000 K
370 lm
209043 € 3,90

Mouse

Base, montatura e diffusori in metallo rifinito con vernice opaca e dettagli in cromo. Diffusori orientabili. Disponibile nelle finiture bianco o nero.

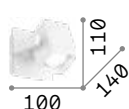
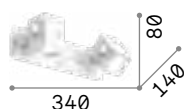

0,910 Kg / 0,0067 m³
GU10 max 2x 50W

€ 127

073545 Bianco
156705 Nero

0,450 Kg / 0,0034 m³
GU10 max 1x 50W

€ 72

073521 Bianco
073569 Nero



108292 € 4,50



108292 € 4,50



P. 310 P. 638



Spot

Base, montatura e diffusori in metallo rifinito con vernice opaca e dettagli in cromo. Diffusori orientabili. Disponibile nelle finiture bianco o nero.

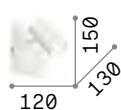

0,610 Kg / 0,0060 m³
GU10 max 2x 50W

€ 52

156736 Bianco
156743 Nero

0,410 Kg / 0,0037 m³
GU10 max 1x 50W

€ 32

156729 Bianco
115481 Nero

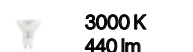

108292 € 4,50

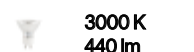

108292 € 4,50



P. 310 P. 638



Gim

Montatura in alluminio verniciato a polveri. Diffusore ruotabile a polveri. Diffusore ruotabile con schermo acrilico satinato. Interruttore incorporato. LED integrati.

LED Sorgente luminosa LED 3000 K, 15.000 h di durata.

ON OFF Lampada con interruttore integrato.



IP20

0,450 Kg / 0,0034 m³
LED 6W / 530 lm

€ 80

167152 Bianco
167121 Nero



Rudy

Montatura in alluminio pressofuso verniciato a polveri bianco o nero. Diffusori orientabili in rotazione e inclinazione.

LED Lampadine LED GU10 7W 3000 K incluse. Cod. 123943



IP20

0,570 Kg / 0,0046 m³
GU10 max 2 x 35W

€ 100

229041 Bianco
229034 Nero

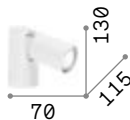

IP20

0,270 Kg / 0,0017 m³
GU10 max 1 x 35W

€ 50

229027 Bianco
229010 Nero

3000 K
610 lm
123943 € 4,50

3000 K
610 lm
123943 € 4,50



P. 311



Oby

Montatura in metallo verniciato bianco opaco, con snodi cromati. Corpo luce orientabile con diffusore in materiale plastico bianco.

LED Sorgente luminosa LED 3000 K, 20.000 h di durata.

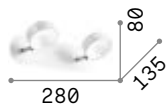

■ □ ⊕ IP20

■ □ ⊕ IP20

0,620 Kg / 0,0030 m³
LED 12W / 1400 lm

0,310 Kg / 0,0020 m³
LED 6W / 700 lm

€ 120

€ 61

196695 ■ Bianco

196688 ■ Bianco



P. 311

Barber

Base, snodo e copri portalampade interamente in metallo. Corpo luce inclinabile. Disponibile nella versione brunito.

LED Lampadine LED GU10 7W 3000 K incluse. Cod. **123943**

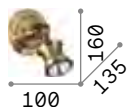

■ □ ⊕ IP20 

0,230 Kg / 0,0025 m³
GU10 max 1x28W

€ 75

159997 ■ Brunito

 3000 K
610 lm

123943 € 4,50



Alfa

Montatura in metallo con finitura in brunito, bianco satinato, nickel satinato od ottone satinato.

Corpo luce posizionabile con rotazione dello stelo e snodo per l'inclinazione.

LED Lampadine LED GU10 7W 3000 K incluse. Cod. **123943**

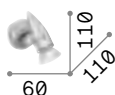

0,390 Kg / 0,0031 m³
GU10 max 2 x 50W

0,170 Kg / 0,0010 m³
GU10 max 1 x 50W

€ 45

€ 23

122717 Bianco
009483 Nickel
287829 Ottone

099057 Bianco
009377 Nickel
285009 Ottone
119786 Brunito

3000 K
610 lm
123943 € 4,50

3000 K
610 lm
123943 € 4,50



P. 314



Slem

Montatura in metallo con finitura in bianco, cromo, nickel satinato od ottone satinato.

Corpo luce posizionabile con rotazione dello stelo e snodo per l'inclinazione.

LED Lampadine LED GU10 7W 3000 K incluse. Cod. **123943**

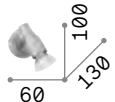
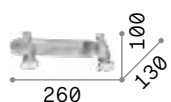

0,400 Kg / 0,0025 m³
GU10 max 2 x 50W

0,200 Kg / 0,0010 m³
GU10 max 1 x 50W

€ 45

€ 23

142081 Bianco
142050 Cromo
018836 Nickel
287836 Ottone

099064 Bianco
122984 Cromo
018829 Nickel
285016 Ottone

3000 K
610 lm
123943 € 4,50

3000 K
610 lm
123943 € 4,50



P. 314



Winery

Corpo luce con portalampage incorporato interamente in ceramica smaltata bianca o nera. Modello AP con assetto inclinato verso il basso.

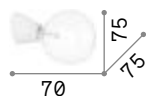

■ □ IP20

0,250 Kg / 0,0004 m³
E27 max 1x60W

€ 27

180298 ■ Bianco
180304 ■ Nero

💡 3000 K
1120 lm

101323 € 7,50 [P. 309](#)



Edison

Montatura in metallo rifinito con vernice opaca bianca o nera. Cavo elettrico in tessuto. Diffusore orientabile.

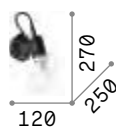

■ ⚡ IP20

0,410 Kg / 0,0134 m³
E27 max 1x60W

€ 62

138374 ■ Bianco
148908 ■ Nero

💡 3000 K
1020 lm

101347 € 8,50 [P. 111](#)





Radio

Rosone e montatura in metallo. Diffusore posizionabile. Cavo elettrico in tessuto. Disponibile con finitura in cromo o con vernice opaca bianca o nera.

LED Lampadine LED E27 8W Globo D125 trasparente 3000 K incluse.
Cod. **101347**



IP20 

0,450 Kg / 0,0119 m³
E27 max 1x60W

€ 72

119465  Bianco
119427  Cromo
119502  Nero

 3000 K
1020 lm

101347 € 8,50



Minimal

Montatura in metallo rifinito in cromo o in smalto colorato. Cavo elettrico con rivestimento in tessuto.

LED

Lampadine LED E27 8W Globo D125 trasparente 3000 K incluse.
Cod. **101347**

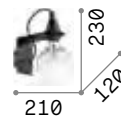

IP20

0,720 Kg / 0,0164 m³
E27 max 1x 60W

€ 77

045191 ■ Bianco
045207 ■ Cromo
045214 ■ Nero

3000 K
1020 lm

101347 € 8,50



P. 112 P. 500



Frida

Montatura e copri porta lampade in metallo con finiture brunito e rame. Cavo in tessuto nero.



IP20

0,430 Kg / 0,0092 m³
E27 max 1x 60W

€ 47

163338 ■ Rame
163321 ■ Brunito

2200 K
500 lm

151717 € 8,90



P. 110



Igor

Montatura in metallo rifinito con vernice opaca nera. Diffusore con lastre di vetro trasparente.



■  IP20

1,590 Kg / 0,0136 m³
E27 max 1x60W

€ 95

092836 ■ Nero

 2200 K
440 lm

151694 € 7,00



P. 093



Birds

Montatura in metallo verniciato con disco decorativo in ottone satinato. Diffusori in vetro soffiato bianco acidato. Colore: nero opaco con dettaglio ottone satinato.

LED Lampadine LED G9 3W 3000 K incluse.
Cod. **209043**

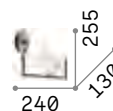

IP20 INCLUSA

0,670 Kg / 0,0192 m³
G9 max 1x 15W

€ 73

273655 ■ Nero

3000 K
370 lm

209043

€ 3,90



P. 094

P. 319

P. 466

P. 492



Kepler

Montatura in metallo verniciato
nero opaco. Diffusori in vetro
soffiato trasparente ambrato.

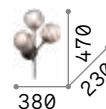

■ □ IP20

0,900 Kg / 0,0428 m³
E27 max 3 x 60W

€ 250

187006 ■ Nero

■ 3000 K
430 lm

101279 € 3,00



P. 101



Perlage ^{new}

Montatura in metallo con struttura lineare a sezione tonda. Finiture: nero opaco con vetri pirex fumé o ottone satinato con vetri bianchi acidati.

LED

Lampadine LED G9 3W 3000 K incluse.
Cod. **209043**

292410



292403

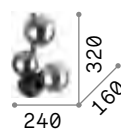

IP20 INCLUSA

0,800 Kg / 0,0219 m³
G9 max 3 x 15W

€ 150

271439 ■ Nero
283784 ■ Ottone

3000 K
370 lm

209043 € 3,90

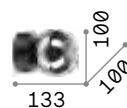

IP20 INCLUSA

0,400 Kg / 0,0062 m³
G9 max 1 x 15W

€ 65

292403 ■ Nero ^{new}
292410 ■ Ottone ^{new}

3000 K
370 lm

209043 € 3,90



P. 096



P. 466



P. 494

Triumph

Montatura interamente in metallo con finitura nero o ottone invecchiato. Modelli AP con cavo in tessuto con interruttore e spina.



Lampada con interruttore integrato.

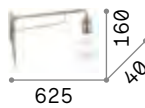

■ □ IP20

0,710 Kg / 0,0067 m³
E27 max 2 x 60W

€ 160

242385 ■ Nero
160245 ■ Ottone

■ □ IP20

0,490 Kg / 0,0083 m³
E27 max 1 x 60W

€ 105

242392 ■ Nero
160214 ■ Ottone



2200 K
370 lm

151687

€ 5,50



2200 K
370 lm

151687

€ 5,50



P. 090



P. 318



Maracas

Montatura interamente in metallo rifinito in bianco od ottone satinato. Diffusori orientabili in vetro soffiato trasparente.

LED

Lampadine LED G4 2W 3000 K incluse.
Cod. 222257

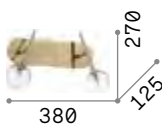

■ ■ □ IP20

0,550 Kg / 0,0049 m³
G4 max 2 x 2W

€ 138

200385 ■ Bianco
200347 ■ Ottone

■ ■ □ IP20

0,280 Kg / 0,0034 m³
G4 max 1 x 2W

€ 72

200378 ■ Bianco
200330 ■ Ottone



3000 K
160 lm

222257

€ 4,50



3000 K
160 lm

222257

€ 4,50



P. 315





Equinoxe

Montatura a bracci in metallo con finitura cromo o ottone antico. Diffusori in vetro soffiato trasparente.

LED Lampadine LED G4 2W 3000 K incluse.
Cod. 222257

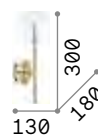

IP20 INCLUSA

0,990 Kg / 0,0243 m³
G4 max 1x2W

€ 131

200132 Cromo
200149 Ottone

3000 K
160 lm

222257 € 4,50



P. 098 P. 495

Cantina

Montatura, diffusore e copriportalampada in metallo disponibile con finitura brunito o rame. Cavo in tessuto.

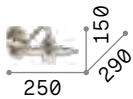

■  IP20

0,520 Kg / 0,0184 m³

E14 max 1x40W

€ 85

112695 ■ Rame

112626 ■ Brunito



3000 K
480 lm



101200

€ 3,00

[P. 129](#)



112695

112626

Newton

Montatura e diffusore in metallo. Disponibile con finitura in nickel satinato, brunito o con vernice nera opaca. Braccio regolabile. Diffusore orientabile smaltato bianco all'interno.

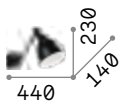

■  IP20

0,600 Kg / 0,0093 m³

E27 max 1x60W

€ 62

016399 ■ Nickel

027852 ■ Nero

027876 ■ Brunito



3000 K
900 lm



123899

€ 7,00

[P. 504](#)



016399

027852

027876



Shower

Montatura in metallo verniciato opaco nero. Elemento snodato in cromo. Diffusore orientabile. Cavo in tessuto con interruttore e spina.



Lampada con interruttore integrato.

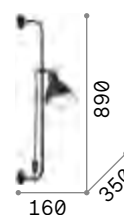

IP20

0,760 Kg / 0,0391 m³
E27 max 1x60W

€ 130

179643 ■ Nero

3000 K
900 lm

123899 € 7,00



Pan

Diffusore con tubi decorativi di diverse misure in metallo placcato. Emissione luce sopra e sotto.

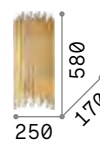

■  IP20

6,340 Kg / 0,0461 m³
E14 max 2x 40W

€ 400

208794  Oro

 3000 K
470 lm

101224 € 3,00



P. 089

Sunrise

Corpo luce interamente in metallo rifinito con vernice opaca nera, interno in foglia oro.

LED Lampadine LED G9 3W 3000 K incluse.
Cod. **209043**

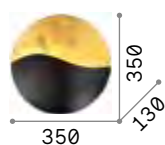

1,290 Kg / 0,0362 m³
G9 max 4 x 40W

€ 225

133300 ■ Nero

3000 K
370 lm

209043 € 3,90

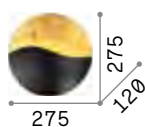

0,850 Kg / 0,0224 m³
G9 max 3 x 40W

€ 195

133270 ■ Nero

3000 K
370 lm

209043 € 3,90

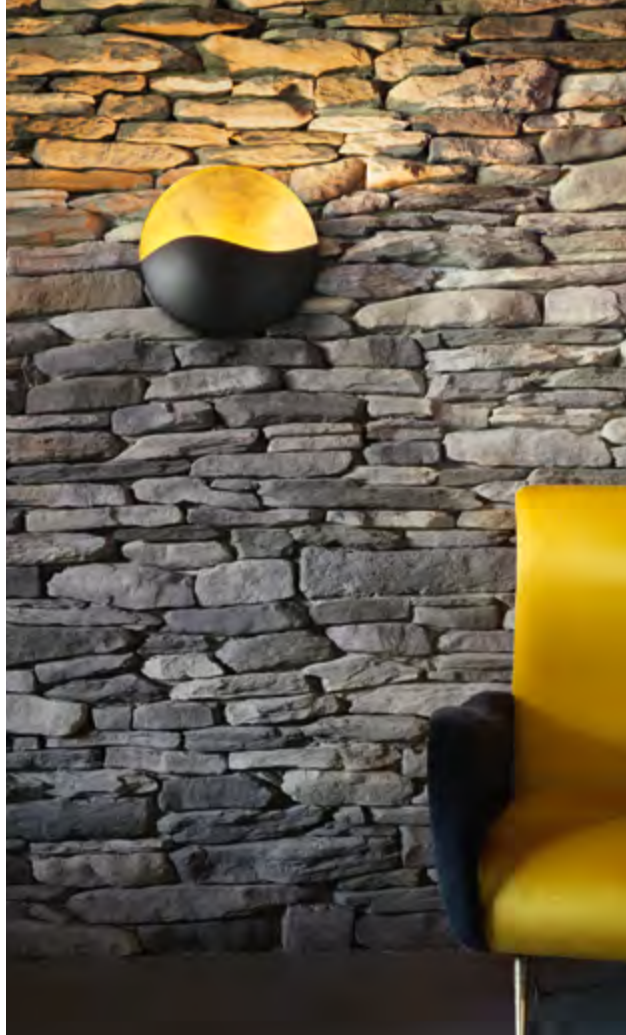

Ninfea ^{new}

Base in metallo verniciato a polveri o placcato. Diffusori in vetro incamiciato bianco, soffiato e acidato. Finiture: bianco oppure ottone satinato.

LED Lampadine LED GX53 9W 3000 K incluse. Cod. **123936**

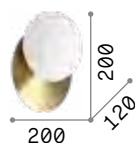

0,800 Kg / 0,0084 m³
GX53 max 1 x 15W

€ 95

306940 ■ Bianco ^{new}

293646 ■ Ottone ^{new}

3000 K
910 lm

123936 € 6,00



P. 329

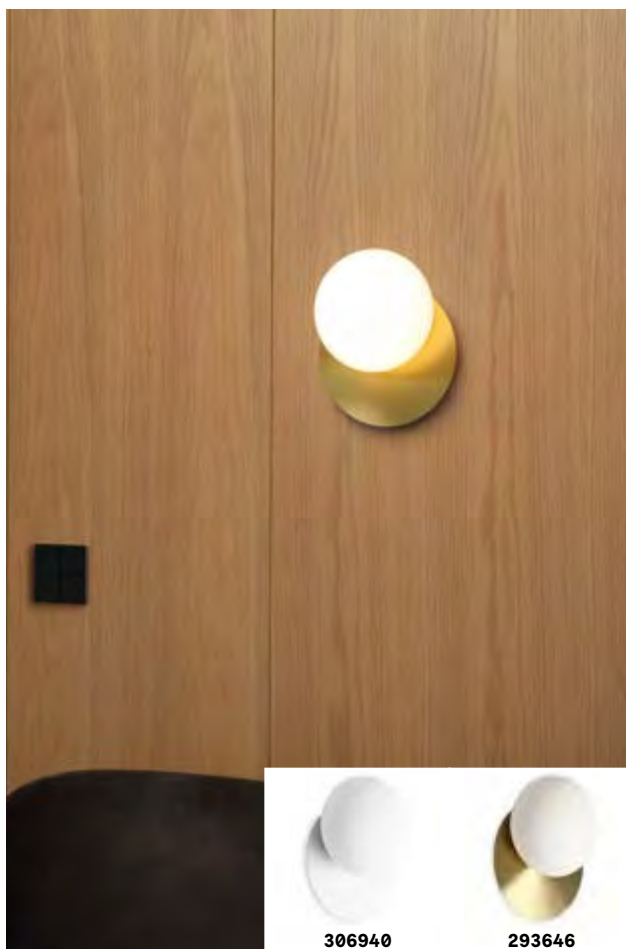



Tick

Corpo luce in metallo verniciato a polveri bianco o rifinito in foglia oro o argento. Diffusore inclinabile di 90°.

LED Sorgente luminosa LED 3000 K, 30.000 h di durata.



238951



238975



238944

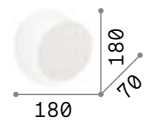

■ □ IP20

0,440 Kg / 0,0029 m³
LED 7,5W / 700 lm

€ 65

238975 ■ Bianco
238951 ■ Argento
238944 ■ Oro



Eclissi

Montatura in metallo rifinito con vernice a polveri e foglia oro. Il posizionamento variabile del diffusore superiore, consente una rifrazione luminosa più bianca o più dorata.

LED Sorgente luminosa LED 3000 K, 17.500 h di durata.



259062



259048

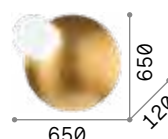

5,600 Kg / 0,0615 m³
LED 30W / 2250 lm

€ 380

259062 ■ Oro

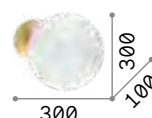

1,400 Kg / 0,0131 m³
LED 11W / 950 lm

€ 115

259048 ■ Oro



P. 192 P. 290 P. 476 P. 522

Set up new

Montature in metallo verniciato a polveri o placcato. Applique a due luci con braccio flessibile rivestito in gomma, interruttori indipendenti e presa USB. Paralumi in pvc ignifugo rivestito di tessuto. Colori montature: bianco, nero oppure nichel satinato o ottone spazzolato con dettagli neri. Colori paralumi: beige, tortora, bianco o nero.



LED Sorgente luminosa LED 3000 K nel modello **259819, 259826, 259833** e **259857**, 20.000 h di durata.

ON/OFF Lampada con interruttore integrato nei modelli: **259819, 259826, 259833** e **259857**.

USB Lampada con presa USB integrata nei modelli: **259819, 259826, 259833** e **259857**.



259765 259796 259772 259802 260068 304113 260075 260082

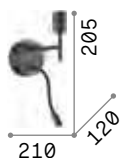

IP20

0,900 Kg / 0,0063 m³
E27 max 1x60W +
LED 3W / 200 lm

€ 115

259819 Bianco
259833 Nickel
259826 Nero
259857 Ottone

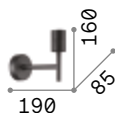

IP20

0,370 Kg / 0,0032 m³
E27 max 1x60W

€ 55

259765 Bianco
259796 Nickel
259772 Nero
259802 Ottone

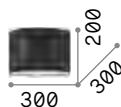

0,023 Kg / 0,0238 m³

€ 55

260433 Bianco
304618 Tortora
270005 Nero
260440 Beige

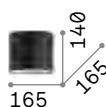

0,012 Kg / 0,0180 m³

€ 28

260327 Bianco
304601 Tortora
269986 Nero
260334 Beige

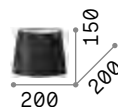

0,013 Kg / 0,0180 m³

€ 29

260068 Bianco
304113 Tortora
260075 Nero
260082 Beige



0,011 Kg / 0,0180 m³

€ 25

260341 Bianco
293004 Tortora
270036 Nero
260358 Beige

3000 K
900 lm
123899 € 7,00

3000 K
900 lm
123899 € 7,00



Hilton

Montatura in cromo. Paralume in lamina di PVC rivestita in tessuto bianco, chiuso da vetro trasparente acidato.



Lampadine LED G9 3W 3000 K incluse.
Cod. **209043**

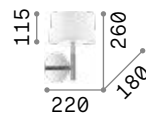

0,700 Kg / 0,0105 m³
G9 max 1x40W

€ 78

075471 **Bianco**

3000 K
370 lm

209043 **€ 3,90**



P. 191



P. 473



P. 527



Woody

Montatura in metallo cromato.
Diffusore in PVC o in tessuto.



Lampadine LED G9 3W 3000 K incluse.
Cod. **209043**



143156



087665

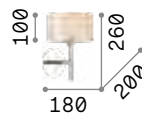

0,460 Kg / 0,0100 m³
G9 max 1x 40W

€ 70

143156 **Bianco**
087665 **Legno**

3000 K
370 lm

209043 **€ 3,90**



P. 190



P. 292

Luxury

Montatura in metallo rifinita in ottone. Base nera opaca. Paralume in pvc con bordi in tessuto.

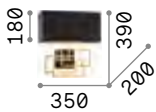

■  IP20

1,220 Kg / 0,0371 m³

E27 max 1x60W

€ 247

201092 ■ Ottone

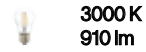

119571

€ 7,00



P. 472



P. 525

Nordik

Montatura in metallo verniciato nero opaco. Paralume in lamina di PVC dorato rivestito in tessuto nero.



Sorgente luminosa LED 3000 K,
20.000 h di durata.



Lampada con interruttore integrato.

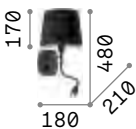

■  IP20

0,630 Kg / 0,0156 m³

E14 max 1x40W +

LED 1,5W / 100 lm

€ 110

158242 ■ Nero

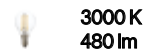

101200

€ 3,00



P. 188



P. 472



P. 524





Hotel

Paralume rivestito in tessuto.
Diffusori in vetro satinato. Modello AP2 con LED esterno orientabile e interruttore indipendente.

LED Sorgente luminosa LED 3000 K nel modello **215693, 035949, 103204, 215709** e **035956**, 20.000 h di durata.

ON OFF Lampada con interruttore integrato nei modelli: **215693, 035949, 103204, 215709** e **035956**.

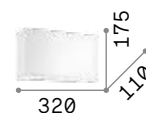
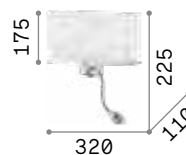

IP20

IP20

1,410 Kg / 0,0166 m³
E27 max 1x60W +
LED 1,5W / 55 lm

1,230 Kg / 0,0166 m³
E27 max 1x60W

€ 115

€ 85

215693 Total White
035949 Bianco
215709 Total Black
035956 Nero
103204 Canvas

152851 Bianco

3000 K
900 lm
123899 € 7,00

3000 K
900 lm
123899 € 7,00

Holiday

Montatura in metallo verniciato opaco. Paralume con lamina di pvc rivestita in tessuto. Interruttore unico con controllo indipendente delle due sorgenti luminose.

LED Sorgente luminosa LED 3000 K, 20.000 h di durata.

ON OFF Lampada con interruttore integrato.

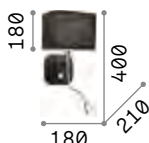

■  IP20

0,640 Kg / 0,0111 m³

E14 max 1x40W +
LED 1,5W / 55 lm

€ 115

124162 **Bianco**

124179 **Nero**

 3000 K
420 lm

101217 € 3,00



124162



124179



Sheraton

Montatura in metallo cromato. Paralumi in lamina di PVC rivestita di tessuto. Applique con luci a controllo indipendente da interruttore unico.

LED Sorgente luminosa LED 3000 K, 15.000 h di durata.

ON OFF Lampada con interruttore integrato.



■  IP20

0,770 Kg / 0,0145 m³

E14 max 1x40W +
LED 1,5W / 55 lm

€ 98

074900 **Bianco**

 3000 K
420 lm

101217 € 3,00





Gea

Corpo luce in alluminio verniciato a polveri bianco o nero. Diffusore con led integrato orientabile. Paralume in pvc rivestito di tessuto. Presa USB. Interruttori indipendenti.

LED Sorgente luminosa LED 3000 K, 20.000 h di durata.

ON/OFF Lampada con interruttore integrato.

USB Lampada con presa USB integrata.



239576



239613



239590



239606

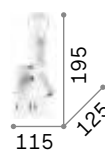

IP20

0,50 Kg / 0,0022 m³
E27 max 1x60W +
LED 3W / 200 lm

€ 125

239521 ■ Bianco
239545 ■ Nero

3000 K
900 lm

123899 € 7,00

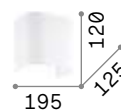

0,140 Kg / 0,0180 m³

€ 17

239576 ■ Bianco
239613 ■ Grigio
239590 ■ Nero
239606 ■ Canvas

Calypso

Montatura in metallo con finitura cromo. Elementi decorativi quadrati in cristallo molato.

LED Lampadine LED G9 3W 3000 K incluse.
Cod. **209043**

■  IP20 

1,420 Kg / 0,0125 m³
G9 max 2x40W

€ 160

044163 ■ Cromo

 3000 K / 370 Lm
209043 € 3,90

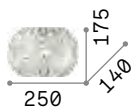

P. 196



Roma

Montatura e dettagli in metallo cromato. Diffusore con elementi quadrati in cristallo molato sulla fascia laterale e vetro sabbato sul fondo.

LED Lampadine LED G9 3W 3000 K incluse.
Cod. **209043**

■  IP20 

1,200 Kg / 0,0147 m³
G9 max 2x40W

€ 160

093086 ■ Cromo

 3000 K / 370 Lm
209043 € 3,90

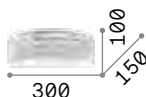

P. 203



P. 332



P. 482



Pashà

Montatura in metallo. Diffusore composto da filari di perle in cristallo molato e fondo chiuso da vetro circolare sabbato.

LED Lampadine LED G9 3W 3000 K incluse.
Cod. **209043**

■  IP20 

1,110 Kg / 0,0057 m³
G9 max 3x40W

€ 210

082264 ■ Cromo
082288 ■ Oro

 3000 K / 370 Lm
209043 € 3,90



P. 205



P. 333



082264



082288



Carlton

Montatura in metallo cromato o dorato. Elementi decorativi con catene di ottagoni e barre in cristallo molato trasparente.

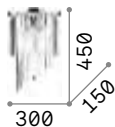

IP20

2,570 Kg / 0,0154 m³
E14 max 3x 40W

€ 170

168913 Cromo
213491 Oro

3000 K
470 lm

101224 € 3,00



P. 202 P. 343



168913



213491

Dubai

Montatura in metallo con finitura cromo o ottone. Elementi decorativi con perle, ottagoni e prismi in cristallo molato trasparente.

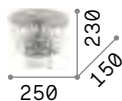

IP20

1,190 Kg / 0,0084 m³
E14 max 2x 40W

€ 210

207155 Cromo
201023 Ottone

3000 K
470 lm

101224 € 3,00



P. 208 P. 341



207155



201023

Opera

Montatura in cromo. Paralume in lamina di PVC con riflessi metallizzati e rivestita da fili. Pendagli in cristallo molato.



Sorgente luminosa LED 3000 K,
15.000 h di durata.



Lampada con interruttore integrato.



1,550 Kg / 0,0220 m³
E14 max 2x 40W +
LED 1,5W / 55 Lm

€ 180

068268 Bianco



3000 K
420 Lm



[P. 194](#)



[P. 483](#)



[P. 529](#)

101217

€ 3,00

Swan

Montatura in cromo. Corpo luce in vetro soffiato e lavorato a mano. Elementi decorativi in cristallo molato. Paralume in tessuto d'organza plissettato.

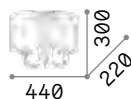

2,470 Kg / 0,0517 m³
E14 max 2x 40W

€ 210

035864 Bianco



3000 K
420 Lm



[P. 195](#)

101217

€ 3,00



Pegaso

Montatura in metallo cromato oppure ottone satinato. Corpo centrale, bobeches e pendagli in cristallo molato. Paralumi in organza.



IP20

1,600 Kg / 0,0302 m³

E14 max 2 x 40W

€ 165

059211 Bianco

197708 Ottone

3000 K
370 lm

101231 € 3,00



P. 212



P. 487



P. 530

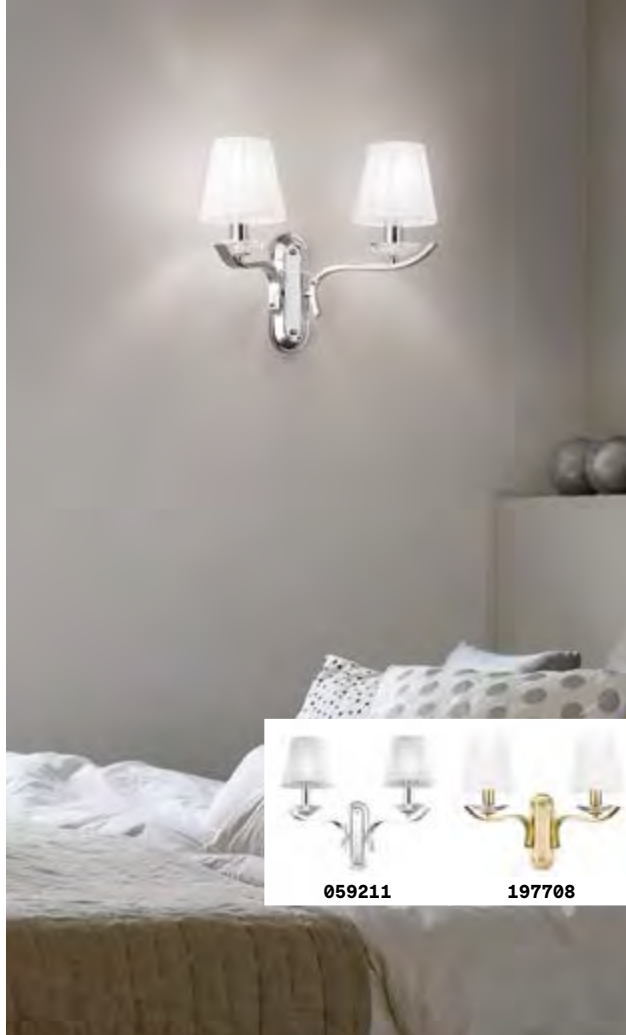

Corte

Montatura completamente in metallo modellato con lavorazione artigianale. Finitura dipinta a mano con effetto antichizzato. Disponibile nella versione bianca o ruggine.

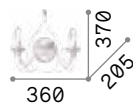

IP20

1,060 Kg / 0,0329 m³

E14 max 2 x 40W

€ 85

028460 Bianco

057200 Ruggine

3000 K
470 lm

101224 € 3,00



P. 228



Negresco

Montatura in metallo con finitura in cromo o dorata. Bracci soffiato trasparente con interno dorato nella versione oro. Centrale composto da blocchi di cristallo molato. Elementi decorativi in vetro trasparente e cristallo molato.

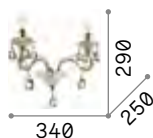

■  IP20

2,320 Kg / 0,0324 m³

E14 max 2x40W

€ 160

141046  Trasparen.

087757  Oro

 3000 K
430 lm

101248

€ 3,00

 P. 218



141046



087757

Florian

Montatura in metallo con elementi decorativi in vetro. Pendagli con ottagononi e gocce finali in cristallo molato. Disponibile nelle versioni con vetro trasparente e metallo dorato o cromato.

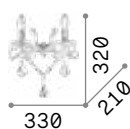

■  IP20

1,430 Kg / 0,0189 m³

E14 max 2x40W

€ 155

035642  Cromo

035659  Oro

 3000 K
470 lm

101224

€ 3,00

 P. 222



035642



035659

Gioconda

Corpo luce in fusione di metallo con finitura oro o argento antico. Pendagli ottagonali e tondi in cristallo molato.

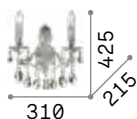

IP20

1,310 Kg / 0,0111 m³

E14 max 2 x 40W

€ 215

044910 Argento

060491 Oro



3000 K
470 lm



101224

€ 3,00

P. 226



044910



060491

Strauss

Montatura e dettagli in metallo con finitura oro rosa. Bracci in vetro soffiato trasparente. Elementi decorativi in cristallo ambrato.

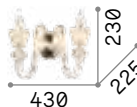

IP20

2,080 Kg / 0,0431 m³

E14 max 2 x 40W

€ 145

140599 Oro



3000 K
430 lm



101248

€ 3,00

P. 230

Firenze

Corpo luce in resina. Bracci e foglie in metallo modellato artigianalmente. Decorato a mano con foglia d'oro e antichizzato.

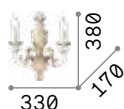

■  IP20

2,050 Kg / 0,0405 m³

E14 max 2x40W

€ 158

012902  Bianco

020846  Oro

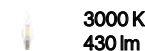

101248 € 3,00



P. 238



P. 481



P. 531



012902

020846

Chalet

Montatura con struttura portante in metallo. Elementi decorativi in resina lavorata artigianalmente e dipinta a mano come fedele riproduzione di corna e legno intagliato.

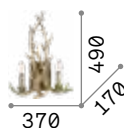

■  IP20

1,770 Kg / 0,0759 m³

E14 max 2x40W

€ 205

115511  Beige

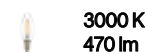

101224 € 3,00



P. 242



P. 480

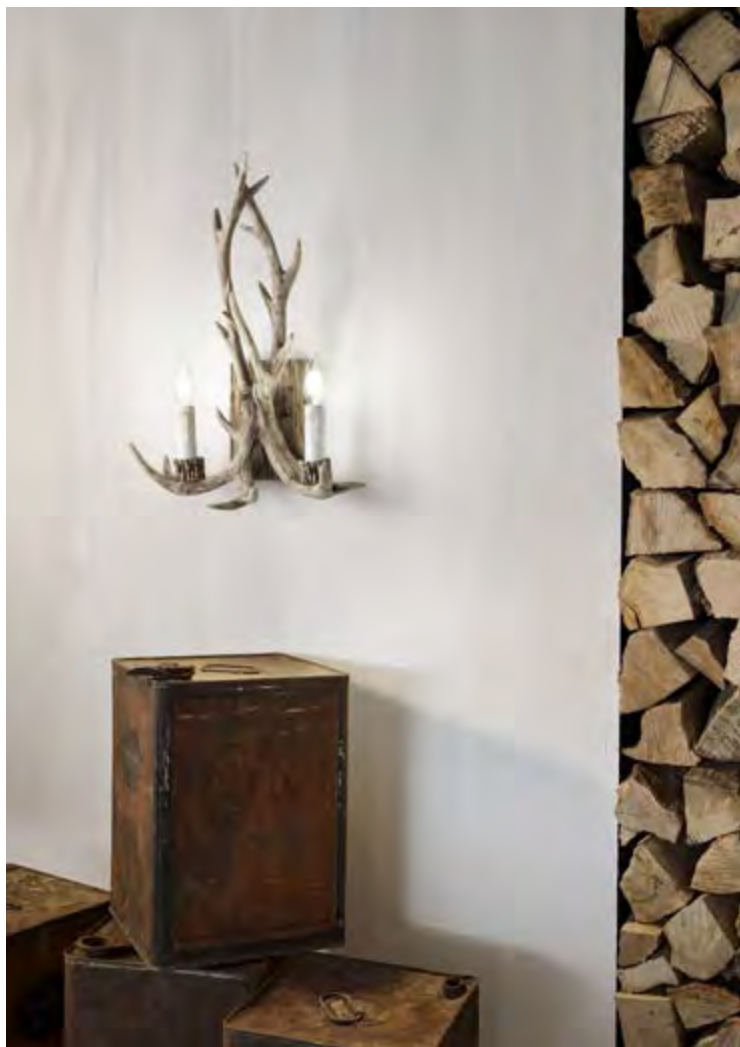



Peter

Montatura in resina lavorata artigianalmente come fedele riproduzione del legno intagliato. Paralume in lamina di PVC rivestito in tessuto canvas.

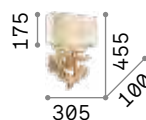

IP20

4,160 Kg / 0,0371 m³
E14 max 2 x 40W

€ 230

075211 Canvas

3000 K
480 lm

101200 € 3,00



Harem

Montatura in metallo brunito con decori in rilievo e cristalli incastonati. Diffusore in vetro soffiato leggermente ambrato. Pendaglio a nappa.

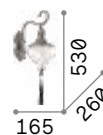

■ □ IP20

0,900 Kg / 0,0273 m³
E27 max 1x42W

€ 200

115962 ■ Brunito

● 3000 K
910 lm

119571 € 7,00



P. 241



Santa

Lampadario in vetro trasparente soffiato e lavorato a mano. Dettagli in metallo cromato. Versione oro disponibile con graniglia sul vetro.



087368



087375

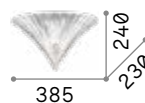

■ IP20

2,900 Kg / 0,0380 m³
E14 max 1x 40W

€ 230

087368 Trasparen.
087375 Oro

3000 K
470 lm

101224 € 3,00

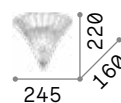

■ IP20

1,200 Kg / 0,0184 m³
E14 max 1x 40W

€ 100

013060 Trasparen.
013046 Oro

3000 K
470 lm

101224 € 3,00



Fiocco

Diffusore di vetro trasparente lavorato in piastra con graniglia. Decoro centrale color ambra. Viti fermavetro in ottone satinato.

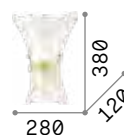

■  IP20

1,800 Kg / 0,0265 m³
E27 max 1x 60W

€ 90

014630 Bianco

 **3000 K**
430 lm

101279 € 3,00

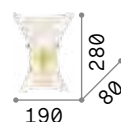

■  IP20

1,080 Kg / 0,0112 m³
E14 max 1x 40W

€ 62

014623 Bianco

 **3000 K**
480 lm

101200 € 3,00



Carrara

Diffusore interamente realizzato con elementi in alabastro, aperto sulle estremità superiore e inferiore.

LED

Lampadine LED G9 3W 3000 K incluse.
Cod. **209043**



■ \oplus IP20 INCLUSA

1,500 Kg / 0,0081 m³
G9 max 2 x 40W

€ 105

018775 ■ Alabastro

3000 K
370 lm

209043 € 3,90

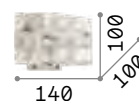

■ \oplus IP20 INCLUSA

1,200 Kg / 0,0049 m³
G9 max 1 x 40W

€ 85

000619 ■ Alabastro

3000 K
370 lm

209043 € 3,90



Interni

Lampade da tavolo



Diesis

Pag 453















































Indice alfabetico

Alfiere	474	Perlage	466
Angolo	467	Pivot	451
Axel	470	Prato	464
Birds	466	Queen	486
Birillo	463	Rain	482
Candy	460	Roma	482
Chalet	480	Sally	457
Diesis	453	Set Up	476
Driftwood	478	Smarties	460
Duchessa	485	Snell	479
Edo	465	Truman	458
Eternity	474	Wally	457
Firenze	481	Yoko	452
Futura	454		
Gru	450		
Hilton	473		
Kali	475		
Kate	484		
Kelly	456		
Lawyer	459		
Le Roy	486		
Lingotto	469		
London	471		
Luxury	472		
Mapa Bianco	461		
Mapa Max	462		
Microphone	468		
Nordik	472		
Opera	483		
Oz	448		
Pegaso	487		

Interni

Indice icone

		new 		new 		
Oz 448	Gru 450	Pivot 451	Yoko 452	Diesis 453	Futura 454	Kelly 456
						
Sally 457	Wally 457	Truman 458	Lawyer 459	Smarties 460	Candy 460	MapaBianco 461
					new 	new 
Mapa Max 462	Birillo 463	Prato 464	Edo 465	Birds 466	Perlage 466	Angolo 467
						
Microphone 468	Lingotto 469	Axel 470	London 471	Nordik 472	Luxury 472	Hilton 473
						
Alfiere 474	Eternity 474	Kali 475	Set Up 476	Driftwood 478	Snell 479	Chalet 480
						
Firenze 481	Roma 482	Rain 482	Opera 483	Kate 484	Duchessa 485	Queen 486
						
					Le Roy 486	Pegaso 487



Oz

Base e montatura in metallo verniciato a polveri o placcato. Cavi in pvc. Diffusore in gomma opale. Disponibile nelle finiture bianco, nero o ottone spazzolato.

LED Sorgente luminosa LED 3000 K, 30.000 h di durata.

ON OFF Lampada con interruttore integrato.

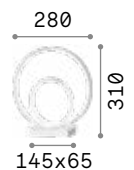

IP20

0,890 Kg / 0,0096 m³
LED 23W / 2300 lm

€ 190

269474 ■ Bianco
269481 ■ Nero
269498 ■ Ottone



Gru

Montatura interamente in metallo. Asta con finitura in cromo. Base e diffusore con finitura in vernice opaca bianca o nera. Diffusore ruotabile e regolabile in altezza.

LED Sorgente luminosa LED 3000 K, 15.000 h di durata.

ON OFF Lampada con interruttore integrato.



147642



147659

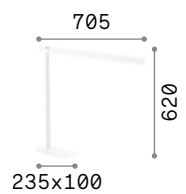

IP20

2,220 Kg / 0,0084 m³
LED 6,3W / 400 lm

€ 185

147642 ■ Bianco
147659 ■ Nero



Pivot **new**

Montatura in alluminio verniciato opaco. Base rivestita in plastica con dimmer. Diffusore orientabile con schermo in PC opale satinato. Cavo in PVC con driver e spina.

LED Sorgente luminosa LED 3000 K, 25.000 h di durata.

ON OFF Lampada con interruttore integrato.

-O+ Lampada con dimmer.

Hand Lampada con dimmer tattile.





Yoko

Base e montatura in metallo verniciato opaco. Diffusore in policarbonato opale. Cavo in pvc con presa-alimentatore. Colori: bianco o nero.

LED Sorgente luminosa LED 3000 K, 30.000 h di durata.

ON OFF Lampada con interruttore integrato.



IP20

0,860 Kg / 0,247 m³
LED 4W / 410 lm

€ 100

258881 Bianco
258911 Nero



P. 081



P. 498



Diesis ^{new}

Montatura in metallo verniciato a polveri o placcato. Diffusore orientabile in rotazione e inclinazione. Cavo in pvc con interruttore. Colori: nero, nichel satinato oppure ottone satinato.

LED Sorgente luminosa LED 3000 K, 20.000 h di durata.

 Lampada con dimmer.

 Lampada con dimmer tattile.

 
P. 117 P. 503



291093

283333



291109



 IP20  

1,700 Kg / 0,0637 m³
LED 6,5W / 600 lm

€ 185

291093  Nickel ^{new}
283333  Nero ^{new}
291109  Ottone ^{new}



Futura

Braccio in alluminio e plastica, snodato con cavo a vista in pvc. Diffusore orientabile a led e interruttore incorporato. Spina con alimentatore.

LED Sorgente luminosa LED 4000 K, 25.000 h di durata.

ON/OFF Lampada con interruttore integrato.

+ Lampada con dimmer.

Hand Lampada con dimmer tattile.





Kelly

Lampada tecnica in metallo con
finitura bianco o nero opaco.
Braccio snodato e bilanciato a molle.
Diffusore orientabile.



Lampada con interruttore integrato.

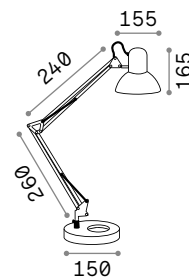

IP20

1,510 Kg / 0,0065 m³
E27 max 1 x 42W

€ 45

108117 ■ Bianco
108094 ■ Nero

3000 K
340 lm

101286 € 3,00



Sally

Lampada tecnica in metallo con finitura bianco, nero opaco oppure nero con snodi in rame. Braccio snodato e bilanciato a molle. Diffusore orientabile.

 Lampada con interruttore integrato.



 IP20

193946

265285

061160

2,600 Kg / 0,0132 m³
E27 max 1x 42W

€ 85

193946  Bianco
265285  Nero
061160  Nero Rame

 3000 K
900 lm
123899 € 7,00

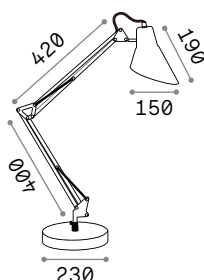

 P. 509



Wally

Lampada tecnica in metallo con finitura bianco, nero opaco oppure nero con snodi in rame. Braccio snodato e bilanciato a molle. Diffusore orientabile.

 Lampada con interruttore integrato.



 IP20

193991

265278

061191

2,450 Kg / 0,0111 m³
E27 max 1x 42W

€ 85

193991  Bianco
265278  Nero
061191  Nero Rame

 3000 K
340 lm
101286 € 3,00

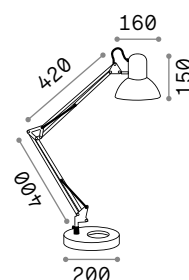

 P. 508



Truman

Montatura e diffusore in metallo rifinito con vernice opaca bianca, grigia o nera. Braccio snodato con raccordi in metallo brunito. Diffusore smaltato bianco all'interno. Cavo rivestito in tessuto vintage bianco e nero.



Lampada con interruttore integrato.



IP20

2,380 Kg / 0,0283 m³
E27 max 1x 60W

€ 85

145198 ■ Bianco
145204 ■ Grigio
145211 ■ Nero

3000 K
430 lm

101279 € 3,00



Lawyer

Montatura in metallo con finitura disponibile in ottone, in cromo o in brunito. Diffusore in vetro soffiato e incamiciato.



Lampada con interruttore integrato.



IP20

1,850 Kg / 0,0373 m³
E27 max 1x60W

€ 105

045047 Cromo
013657 Ottone
045030 Brunito



3000 K
910 lm
119571 € 7,00



Smarties

Base in metallo. Diffusore in vetro soffiato acidato. Cavo elettrico con spina e interruttore.

LED Lampadine LED G9 3W 3000 K incluse.
Cod. **209043**

ON/OFF Lampada con interruttore integrato.

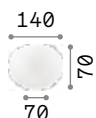

IP20

0,470 Kg / 0,0079 m³
G9 max 1x15W

€ 50

032078 Bianco

3000 K
370 Lm

209043

€ 3,90



P. 152



P. 283



P. 375



Candy

Montatura in metallo con finitura nickel satinato. Diffusore in vetro bianco soffiato e acidato.

LED Lampadine LED G9 3W 3000 K incluse.
Cod. **209043**

ON/OFF Lampada con interruttore integrato.

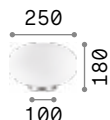

IP20

1,200 Kg / 0,0287 m³
G9 max 1x40W

€ 102

086804 Bianco

3000 K
370 Lm

209043

€ 3,90



P. 155



P. 285



Mapa Bianco

Base e sistema di fissaggio in metallo bianco. Diffusore a sfera in vetro bianco soffiato e acidato.



Lampada con interruttore integrato.

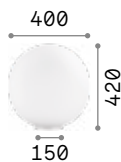

3,520 Kg / 0,1354 m³
E27 max 1x60W

€ 165

000206 Bianco

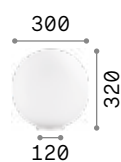

1,880 Kg / 0,0515 m³
E27 max 1x60W

€ 85

009131 Bianco

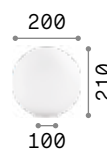

1,050 Kg / 0,0214 m³
E27 max 1x60W

€ 50

009155 Bianco



P. 162



P. 284



P. 374



3000 K
910 lm

119571

€ 7,00



3000 K
910 lm

119571

€ 7,00



3000 K
910 lm

119571

€ 7,00



Mapa Max

Montatura in metallo cromato.
Diffusore in vetro soffiato con
decorazione interna in filo
d'alluminio.



Lampada con interruttore integrato.



P. 159

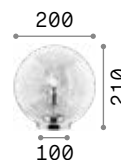

0,970 Kg / 0,0287 m³
E27 max 1x60W

€ 72

045139 Cromo

3000 K
910 lm

119571 € 7,00



Birillo

Lampada da tavolo o da terra con base in metallo cromato e diffusore in vetro soffiato bianco e acidato o fumè.



Lampada con interruttore integrato.



000251



116570



2,310 Kg / 0,0454 m³
E27 max 1x60W

€ 155

000251 Bianco
116587 Fumè

3000 K
910 lm
119571 € 7,00

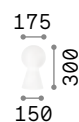

1,240 Kg / 0,0248 m³
E27 max 1x60W

€ 98

000268 Bianco
116570 Fumè

3000 K
910 lm
119571 € 7,00



Prato

Diffusore in vetro soffiato bianco incamiciato e acidato. Cavo elettrico con spina e interruttore.



Lampada con interruttore integrato.

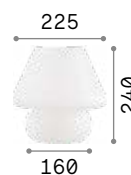

1,380 Kg / 0,0219 m³
E27 max 1x 60W

€ 80

074702 Bianco

3000 K
340 lm

101286 € 3,00



0,650 Kg / 0,0099 m³
E14 max 1x 40W

€ 51

074726 Bianco

3000 K
420 lm

101217 € 3,00



Edo

Montatura interna in metallo cromato. Diffusore in vetro bianco soffiato, incamiciato e acidato.



Lampada con interruttore integrato.



IP20

1,150 Kg / 0,0172 m³
E27 max 1x60W

€ 66

044590 Bianco

3000 K
900 lm

123899 € 7,00



IP20

0,730 Kg / 0,0082 m³
E27 max 1x60W

€ 50

044606 Bianco

3000 K
340 lm

101286 € 3,00



292441



292458

Birds

Montatura in metallo verniciato con disco decorativo in ottone satinato. Diffusori in vetro soffiato bianco acidato. Cavo in pvc con interruttore e spina. Colore: nero opaco con dettaglio ottone satinato.

LED

Lampadine LED G9 3W 3000 K incluse. Cod. **209043**

ON
OFF

Lampada con interruttore integrato.

130x160



IP20

0,900 Kg / 0,0163 m³
G9 max 1x15W

€ 86

273679 ■ Nero

3000 K
370 lm

209043

€ 3,90



P. 094



P. 319



P. 413



P. 492

Perlage ^{new}

Montatura in metallo con struttura lineare a sezione tonda. Finiture: nero opaco con vetri pirex fumé o ottone satinato con vetri bianchi acidati.

LED

Lampadine LED G9 3W 3000 K incluse. Cod. **209043**

ON
OFF

Lampada con interruttore integrato.

240



IP20

2,000 Kg / 0,0227 m³
G9 max 3 x 15W

€ 175

292465 ■ Nero

new

292441 ■ Nero

new

292472 ■ Ottone

new

292458 ■ Ottone

new

3000 K
370 lm

209043

€ 3,90

100



IP20

0,600 Kg / 0,0062 m³
G9 max 1x15W

€ 75

3000 K
370 lm

209043

€ 3,90



P. 096



P. 415



P. 494



Angolo ^{new}

Montatura in metallo verniciato a polveri o placcato. Diffusori in vetro bianco, soffiato e acidato. Cavo in PVC nero con interruttore e spina. Finiture: nero oppure ottone satinato.

LED Lampadine LED G9 3W 3000 K incluse.
Cod. **209043**

ON OFF Lampada con interruttore integrato.



284316



284361



120

120

IP20

INCLUSA

0,600 Kg / 0,0063 m³
G9 max 1x 28W

€ 75

284316 ■ Nero ^{new}284361 ■ Ottone ^{new}

P. 326



P. 496

3000 K
370 lm

209043

€ 3,90



Microphone

Base e montatura in metallo verniciato a polveri nero o placcato ottone. Cavo rivestito in tessuto con interruttore incorporato.

LED

Lampadine LED E27 8W Globo D95 3000 K incluse. Cod. **101323**

ON OFF

Lampada con interruttore integrato.



232485

232546



IP20 

0,490 Kg / 0,0043 m³
E27 max 1 x 60W

€ 77

232485  Nero
232546  Ottone

 3000 K
1120 lm

101323 € 7,50



P. 501



Lingotto

Base e montatura in metallo verniciato opaco. Cavo in pvc nero con interruttore. Diffusore in vetro soffiato bianco e acidato. Colore nero e oro metallizzato.

LED Lampadine LED G9 3W 3000 K incluse nel modello **259222**. Cod. **209043**

ON/OFF Lampada con interruttore integrato.

 
P. 092 P. 327



 IP20

1,320 Kg / 0,0199 m³
E14 max 1x 40W

€ 125

251127  Ottone

 3000 K
420 lm

101217 € 3,00



 IP20 INCLUSA

0,750 Kg / 0,0084 m³
G9 max 1x 28W

€ 90

259222  Ottone

 3000 K
370 lm

209043 € 3,90



Axel

Base e raccordi in metallo verniciato a polveri. Stelo in legno naturale. Paralume regolabile in altezza, in pvc rivestito di tessuto. Cavo in pvc con interruttore. Colori: bianco o nero.



Lampada con interruttore integrato.

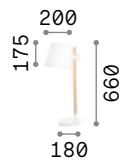

IP20

1,920 Kg / 0,0185 m³
E27 max 1x 60W

€ 140

282091 ■ Bianco
272238 ■ Nero

3000 K
910 lm

119571 € 7,00



P. 517



London

Montatura in metallo rifinito in cromo o con vernice opaca bianca o nera. Paralume in lamina di PVC rivestito di tessuto, per la versione cromo in lamina di PVC cromata e semi trasparente.



Lampada con interruttore integrato.



110530



032368



110554

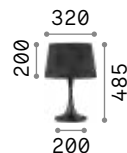

IP20

1,910 Kg / 0,0645 m³
E27 max 1x60W

€ 110

110448 ■ Bianco
032375 ■ Cromo
110455 ■ Nero

3000 K
910 lm

119571 € 7,00

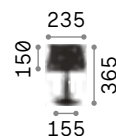

IP20

1,270 Kg / 0,0253 m³
E27 max 1x60W

€ 80

110530 ■ Bianco
032368 ■ Cromo
110554 ■ Nero

3000 K
910 lm

119571 € 7,00



P. 188



P. 521



Nordik

Montatura in metallo verniciato nero opaco. Paralume in lamina di PVC dorato rivestito in tessuto nero.



Lampada con interruttore integrato.

Luxury

Montatura in metallo rifinita in ottone. Base nera opaca. Paralume in pvc con bordi in tessuto.



Lampada con interruttore integrato.

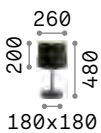

1,220 Kg / 0,0504 m³
E27 max 1x60W

€ 115

161686 ■ Nero



3000 K
910 lm

119571

€ 7,00



P. 188



P. 428



P. 524

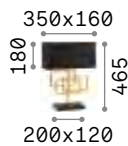

2,890 Kg / 0,0333 m³
E27 max 1x60W

€ 300

201115 ■ Ottone



3000 K
910 lm

119571

€ 7,00



P. 428



P. 525



Hilton

Montatura in cromo. Paralume in lamina di PVC rivestita in tessuto. Diffusore in vetro trasparente sabbiato.

LED Lampadine LED G9 3W 3000 K incluse nel modello **075525**. Cod. **209043**

ON OFF Lampada con interruttore integrato.

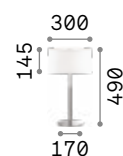

IP20

2,180 Kg / 0,0431 m³
E14 max 2x40W

€ 165

075532 Bianco

3000 K
420 Lm

101217 € 3,00

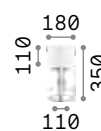

IP20 INCLUSA

0,830 Kg / 0,0109 m³
G9 max 1x40W

€ 110

075525 Bianco

3000 K
370 lm

209043 € 3,90



P. 191 P. 426 P. 527



Alfiere

Base in metallo cromato. Paralume in lamina di PVC ignifuga colore cromo e semitrasparente.



Lampada con interruttore integrato.

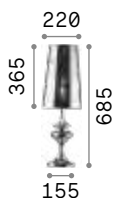

1,230 Kg / 0,0276 m³
E27 max 1x 60W

€ 126

032436 Cromo



3000 K
910 lm

119571

€ 7,00

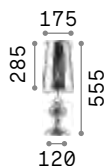

0,920 Kg / 0,0139 m³
E27 max 1x 60W

€ 106

032467 Cromo



3000 K
910 lm

119571

€ 7,00



Eternity

Base in fusione di metallo. Finitura cromo con paralume di organza plissettata e riflessi metallizzati.



Lampada con interruttore integrato.

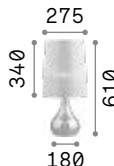

1,720 Kg / 0,0378 m³
E27 max 1x 60W

€ 125

036007 Argento



3000 K
900 lm

123899

€ 7,00

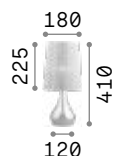

0,770 Kg / 0,0128 m³
E14 max 1x 40W

€ 75

035987 Argento



3000 K
420 lm

101217

€ 3,00



Kali

Corpo luce in ceramica con decori in rilievo. Paralume in pvc rivestito con tessuto. Cavo in pvc con interruttore integrato.



Lampada con interruttore integrato.



0,660 Kg / 0,0092 m³
E14 max 1x40W

€ 28

245331 Bianco

3000 K
420 lm
101217 € 3,00



0,620 Kg / 0,0037 m³
E14 max 1x40W

€ 28

245348 Bianco

3000 K
420 lm
101217 € 3,00

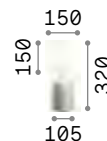

0,660 Kg / 0,0055 m³
E14 max 1x40W

€ 28

245393 Bianco

3000 K
420 lm
101217 € 3,00



Set up ^{new}

Montature in metallo verniciato a polveri o placcato. Paralumi in pvc ignifugo rivestito di tessuto. Colori montature: bianco, nero oppure nichel satinato o ottone spazzolato. Colori paralumi: beige, tortora, bianco o nero.



Lampada con interruttore integrato.



259918

259949

259925

259956

260068

304113

260075

260082

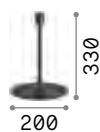

1,130 Kg / 0,0055 m³
E27 max 1x60W

€ 78

259918 Bianco
259949 Nickel
259925 Nero
259956 Oro

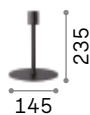

0,680 Kg / 0,0061 m³
E27 max 1x60W

€ 61

259864 Bianco
259895 Nickel
259871 Nero
259901 Oro

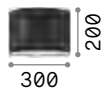

0,023 Kg / 0,0238 m³

€ 55

260433 Bianco
304618 Tortora
270005 Nero
260440 Beige



0,012 Kg / 0,0180 m³

€ 28

260327 Bianco
304601 Tortora
269986 Nero
260334 Beige



0,013 Kg / 0,0180 m³

€ 29

260068 Bianco
304113 Tortora
260075 Nero
260082 Beige



0,011 Kg / 0,0180 m³

€ 25

260341 Bianco
293004 Tortora
270036 Nero
260358 Beige



3000 K
900 lm

123899

€ 7,00



3000 K
900 lm

123899

€ 7,00



Driftwood

Montatura in metallo. Elementi decorativi con rami di legno naturale. Diffusore in lamina di pvc rivestito con tessuto canvas.



Lampada con interruttore integrato.



P. 243



P. 518

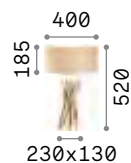

IP20

2,450 Kg / 0,0709 m³
E27 max 1x60W

€ 220

129570 ■ Legno



2200 K
370 Lm

151687

€ 5,50



Snell

Base in legno naturale. Corpo luce formato da rami veri. Paralume in lamina di pvc rivestita di tessuto.



Lampada con interruttore integrato.

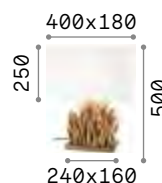

■ □ IP20

1,400 Kg / 0,0733 m³
E27 max 1x60W

€ 250

201399 ■ Bianco

● 3000 K
900 lm

123899 € 7,00

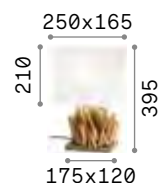

■ □ IP20

1,290 Kg / 0,0389 m³
E27 max 1x60W

€ 225

201382 ■ Bianco

● 3000 K
900 lm

123899 € 7,00



Chalet

Montatura con struttura portante in metallo. Elementi decorativi in resina lavorata artigianalmente e dipinta a mano come fedele riproduzione di corna e legno intagliato.



Lampada con interruttore integrato.



P. 242



P. 438

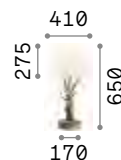

IP20

3,500 Kg / 0,1650 m³
E27 max 1x60W

€ 280

128207 Beige

3000 K
910 lm

119571 € 7,00



Firenze

Corpo luce in resina. Bracci e foglie in metallo modellato artigianalmente. Decorato a mano con foglia d'oro e antichizzato.



Lampada con interruttore integrato.



012889



020853

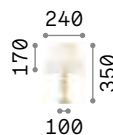

IP20

1,220 Kg / 0,0216 m³
E14 max 1x 40W

€ 135

012889 ■ Bianco
020853 ■ Oro

3000 K
480 lm

101200 € 3,00



P. 238



P. 438



P. 531



Roma

Montatura e dettagli in metallo cromato. Diffusore con elementi quadrati in cristallo molato sulla fascia laterale e vetro sabbiato sul fondo.

LED

Lampadine LED G9 3W 3000 K incluse.
Cod. **209043**

**ON
OFF**

Lampada con interruttore integrato.



IP20

1,930 Kg / 0,0182 m³
G9 max 1x40W

€ 145

114620 Cromo

3000 K
370 lm

209043

€ 3,90



[P. 203](#)



[P. 332](#)



[P. 432](#)



Rain

Montatura in metallo cromato.
Pendagli con elementi in cristallo molato in varie forme e gocce finali.

**ON
OFF**

Lampada con interruttore integrato.



IP20

2,030 Kg / 0,0249 m³
E14 max 2x40W

€ 150

008356 Cromo

3000 K
470 lm

101224

€ 3,00



[P. 199](#)



[P. 339](#)



Opera

Montatura in cromo. Paralume in lamina di PVC con riflessi metallizzati e rivestita da fili. Pendagli in cristallo molato.



Lampada con interruttore integrato.

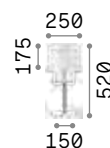

IP20

1,750 Kg / 0,0392 m³
E27 max 1x60W

€ 145

068305 Bianco

3000 K
900 lm

123899 € 7,00



P. 194



P. 434



P. 529



Kate

Corpo luce con elementi di cristallo trasparente molato. Paralumi in tessuto doppio, plissettato.



Lampada con interruttore integrato.



122878



122885

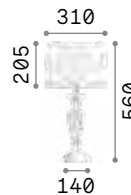

IP20

2,990 Kg / 0,0605 m³
E27 max 1x 60W

€ 275

122878 Bianco

3000 K
900 lm

123899 € 7,00

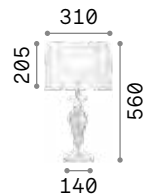

IP20

2,810 Kg / 0,0605 m³
E27 max 1x 60W

€ 275

122885 Bianco

3000 K
900 lm

123899 € 7,00



Duchessa

Base e dettagli in metallo cromato.
Elementi decorativi in vetro soffiato
e lavorato a mano. Paralume in
tessuto di organza plissettato.



Lampada con interruttore integrato.

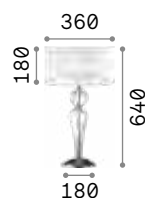

IP20

3,000 Kg / 0,0652 m³
E27 max 1x60W

€ 155

044491 Trasparen.

3000 K
900 lm

123899 € 7,00

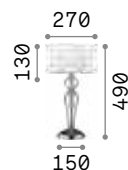

IP20

1,900 Kg / 0,0610 m³
E27 max 1x60W

€ 135

051406 Trasparen.

3000 K
900 lm

123899 € 7,00

Queen

Montatura in metallo dorato con elementi decorativi e base in cristallo molato. Paralume in lamina di PVC, rivestita in tessuto con decorazione trapuntata e brillantini dorati.

ON
OFF Lampada con interruttore integrato.

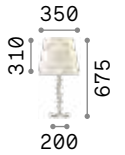

■ □ IP20

2,300 Kg / 0,0886 m³
E27 max 1x60W

€ 210

077758 ■ Oro

■ 3000 K
910 lm

119571 € 7,00

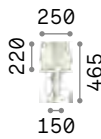

■ □ IP20

1,360 Kg / 0,0460 m³
E27 max 1x60W

€ 140

077741 ■ Oro

■ 3000 K
910 lm

119571 € 7,00

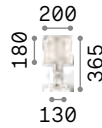

■ □ IP20

0,900 Kg / 0,0137 m³
E27 max 1x60W

€ 120

077734 ■ Oro

■ 3000 K
910 lm

119571 € 7,00



P. 530



Le Roy

Montatura e base in metallo cromato con elementi decorativi in cristallo molato. Paralume in lamina di PVC, rivestita in tessuto con decorazione trapuntata e brillantini argentati.

ON
OFF Lampada con interruttore integrato.

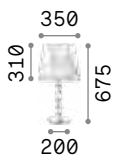

■ □ IP20

2,300 Kg / 0,0919 m³
E27 max 1x60W

€ 195

073408 ■ Cromo

■ 3000 K
910 lm

119571 € 7,00



■ □ IP20

1,360 Kg / 0,0456 m³
E27 max 1x60W

€ 127

073422 ■ Cromo

■ 3000 K
910 lm

119571 € 7,00

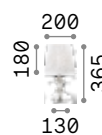

■ □ IP20

0,900 Kg / 0,0234 m³
E27 max 1x60W

€ 110

073439 ■ Cromo

■ 3000 K
910 lm

119571 € 7,00





Pegaso

Montatura in metallo cromato oppure ottone satinato. Corpo centrale, bobeches e pendagli in cristallo molato. Paralumi in organza.



Lampada con interruttore integrato.



059266



197753

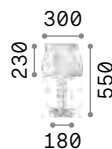

IP20

2,000 Kg / 0,0705 m³
E27 max 1x60W

€ 215

059259 ■ Bianco

3000 K
900 lm

123899



IP20

1,450 Kg / 0,0117 m³
E14 max 1x40W

€ 110

059266 ■ Bianco
197753 ■ Ottone

3000 K
420 lm

101217

€ 3,00



P. 212



P. 435



P. 530



Interni

Lampade da terra



Indice alfabetico

Angolo	496	Newton	504
Audio	497	Nordik	524
Axel	517	Opera	529
Birds	492	Pagoda	515
Colonna	526	Pegaso	530
Comfort	506	Perlage	494
Craft	502	Polly	510
Cylinder	524	Queen	530
Daddy	514	Regol	520
Diesis	503	Sally	509
Dorsale	512	Set Up	522
Driftwood	518	Stage	511
Elvis	505	Wally	508
Eminent	516	Yoko	498
Equinoxe	495	York	519
Eva	499		
Firenze	531		
Forcola	528		
Futura	507		
Hilton	527		
Klimt	519		
London	521		
Luxury	525		
Microphone	501		
Minimal	500		

Equinoxe

Pag 495



new



new



new



Birds 492

Perlage 494

Equinoxe 495

Angolo 496

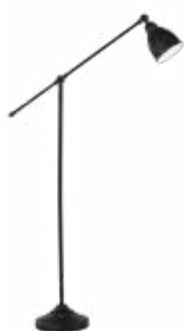

Newton 504



Elvis 505

new



Comfort 506



Futura 507



Pagoda 515



Eminent 516



Axel 517



Nordik 524



Luxury 525

Interni

Indice icone

new

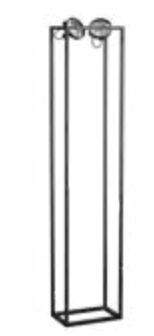

Audio 497

new



Yoko 498



Eva 499



Minimal 500



Microphone 501

new



Craft 502



Diesis 503



Wally 508



Sally 509



Polly 510



Stage 511



Dorsale 512



Daddy 514



Driftwood 518



York 519



Klimt 519



Regol 520



London 521



Set Up 522



Cylinder 524



Colonna 526

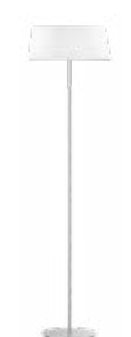

Hilton 527



Forcola 528



Opera 529



Queen 530



Pegaso 530



Firenze 531



Birds

Montatura in metallo verniciato con disco decorativo in ottone satinato. Diffusori in vetro soffiato bianco acidato. Cavo in pvc con interruttore e spina. Colore: nero opaco con dettaglio ottone satinato.

LED Lampadine LED G9 3W 3000 K incluse.
Cod. **209043**

ON
OFF Lampada con interruttore integrato.

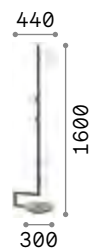

IP20  INCLUSA

5,640 Kg / 0,1536 m³
G9 max 5 x 15W

€ 340

273662 ■ Nero

 3000 K
370 lm

209043

€ 3,90



P. 094



P. 319



P. 413



P. 466



Perlage **new**

Montatura in metallo con struttura lineare a sezione tonda. Finiture: nero opaco con vetri pirex fumé o ottone satinato con vetri bianchi acidati.

LED Lampadine LED G9 3W 3000 K incluse.
Cod. **209043**

ON OFF Lampada con interruttore integrato.



P. 096 P. 415 P. 466

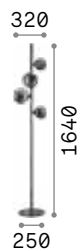

IP20

4,800 Kg / 0,0612 m³
G9 max 4 x 15W

€ 285

306988 ■ Nero **new**
277967 ■ Ottone **new**

3000 K
370 lm
209043 € 3,90



Equinoxe new

Montatura a bracci in metallo con finitura cromo o ottone antico. Diffusori in vetro soffiato trasparente.

LED

Lampadine LED G4 2W 3000 K incluse.
Cod. 222257

**ON
OFF**

Lampada con interruttore integrato.



P. 098



P. 417

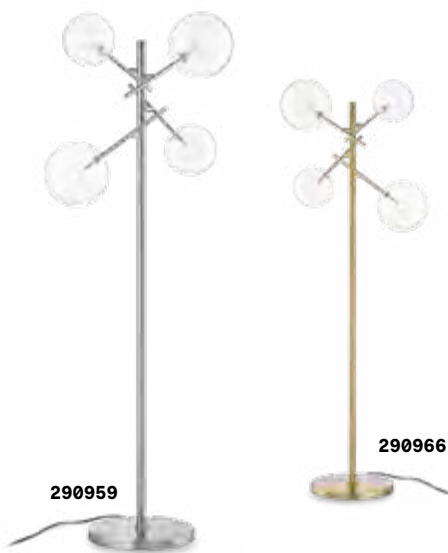

IP20 INCLUSA

6,500 Kg / 0,0882 m³
G4 max 4 x 2W

€ 500

290959 **Cromo** new

290966 **Ottone** new

3000 K
160 lm

222257

€ 4,50



Angolo **new**

Montatura in metallo verniciato a polveri o placcato. Diffusori in vetro bianco, soffiato e acidato. Cavo in PVC nero con interruttore e spina. Finiture: nero oppure ottone satinato.

LED Lampadine LED G9 3W 3000 K incluse. Cod. **209043**

ON OFF Lampada con interruttore integrato.



P. 326



P. 467



284309



284354

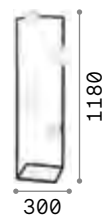

IP20 STYLUS

2,700 Kg / 0,1772 m³
G9 max 5 x 28W

€ 280

284309 ■ Nero **new**
284354 ■ Ottone **new**

3000 K
370 lm
209043 € 3,90



Audio new

Montatura e diffusori orientabili in metallo verniciato a polveri. Cavo di alimentazione in PVC con spina e interruttore incorporato. Finiture: bianco oppure nero.

LED Lampadine LED GU10 10W 3000 K incluse. Cod. **189031**















ON OFF Lampada con interruttore integrato.



279305



279312

 340x210	 210x210	 380x190
   INCLUSA	   INCLUSA	   INCLUSA
7,400 Kg / 0,1063 m³ GU10 max 2 x 50W	6,270 Kg / 0,0772 m³ GU10 max 3 x 50W	2,000 Kg / 0,0213 m³ GU10 max 2 x 50W
€ 498	€ 478	€ 248
306322 Bianco new 293691 Nero	306339 Bianco new 293684 Nero	279305 Bianco new 279312 Nero new
 3000 K 800 lm	 3000 K 800 lm	 3000 K 800 lm
189031 € 15,00	189031 € 15,00	189031 € 15,00



Yoko

Base e montatura in metallo verniciato opaco. Diffusore in policarbonato opale. Cavo in pvc con presa-alimentatore. Colori: bianco o nero.

LED Sorgente luminosa LED 3000 K, 30.000 h di durata.

ON OFF Lampada con interruttore integrato.



P. 081



P. 452

258874



258904



IP20

1,650 Kg / 0,0534 m³
LED 16W / 1350 lm

€ 160

258874 ■ Bianco
258904 ■ Nero



Eva new

Base in marmo. Montatura in metallo verniciato a polveri. Cavo in PVC con interruttore e spina. Finiture: bianco oppure nero.



Lampada con interruttore integrato.

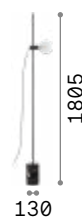

IP20

8,500 Kg / 0,0680 m³
E27 max 1x60W

€ 250

306568 Bianco new
295213 Nero new

 3000 K
1020 lm

101347 € 8,50



Minimal

Montatura in metallo rifinito in smalto colorato nero. Cavo elettrico con rivestimento in tessuto.

LED

Lampadine LED E27 8W Globo D125 trasparente 3000 K incluse.
Cod. **101347**

**ON
OFF**

Lampada con interruttore integrato.



P. 112



P. 410



IP20  

5,840 Kg / 0,0806 m³
E27 max 1x60W

€ 192

163369 ■ Nero



3000 K
1020 lm

101347

€ 8,50



Microphone

Base e montatura in metallo verniciato a polveri nero o placcato ottone. Cavo rivestito in tessuto con interruttore incorporato.

LED Lampadine LED E27 8W Globo D125 3000 K incluse. Cod. **101347**

ON OFF Lampada con interruttore integrato.



232331

232409



230

1700



2,320 Kg / 0,0425 m³
E27 max 1x 60W

€ 185

232331 ■ Nero
232409 ■ Ottone

3000 K
1020 lm

101347

€ 8,50



P. 468



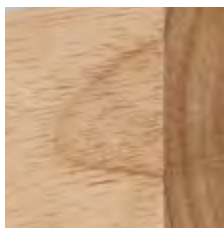

Craft new

Base in metallo verniciato nero opaco. Corpo luce in legno naturale. Diffusore in policarbonato opale satinato. Cavo in PVC nero con dimmer e spina.



LED Sorgente luminosa LED 3000 K, 20.000 h di durata.

 Lampada con dimmer.

 Lampada con interruttore integrato.

 
 P. 083 P. 364

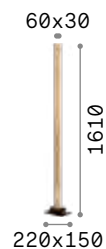

3,500 Kg / 0,0586 m³
LED 26W / 2500 lm

€ 395

284484  **Legno** new



Diesis

Montatura in metallo verniciato a polveri o placcato. Diffusore orientabile in rotazione e inclinazione. Cavo in pvc con interruttore. Colori: nero, nichel satinato oppure ottone satinato.

LED Sorgente luminosa LED 3000 K, 20.000 h di durata.

ON/OFF Lampada con interruttore integrato.



285337

279800

285344

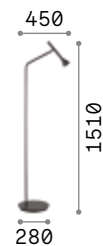

IP20

3,500 Kg / 0,0222 m³
LED 4,5W / 300 lm

€ 205

285337 Nickel
279800 Nero
285344 Ottone



P. 117



P. 453



Newton

Montatura e diffusore in metallo.
Disponibile con finitura in nickel satinato o con vernice nera opaca.
Braccio regolabile. Diffusore orientabile smaltato bianco all'interno.

ON
OFF Lampada con interruttore integrato.

P. 418

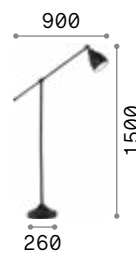

 IP20

5,270 Kg / 0,0323 m³
E27 max 1 x 60W

€ 120

015286  Nickel
003528  Nero

 3000 K
900 lm
123899 € 7,00



Elvis

Montatura in metallo cromato.
Diffusore orientabile in metallo
colorato e dettagli in cromo
all'esterno, smaltato bianco
all'interno.

ON
OFF Lampada con interruttore integrato.

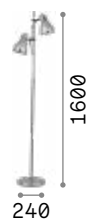

IP20

3,600 Kg / 0,0277 m³
E27 max 2 x 60W

€ 150

042794 ■ Argento
001197 ■ Nero

3000 K
910 lm
119571 € 7,00



Comfort **new**

Montatura in alluminio verniciato a polveri. Diffusore in policarbonato opale anti abbagliamento. Emissione luce sopra e sotto. Interruttore con dimmer, sensore di luminosità, presa USB. Cavo in PVC, con spina. Finiture: bianco oppure nero.

LED Sorgente luminosa LED 3000/4000 K, 50.000 h di durata.

+ Lampada con dimmer.

USB Lampada con presa USB integrata.

UGR Articolo con UGR <19.



12,700 Kg / 0,0326 m³
LED 76W / 10100/10600 lm

€ 1250

296685	Bianco	3000K	new
306452	Bianco	4000K	new
296678	Nero	3000K	new
306469	Nero	4000K	new



Futura

Braccio in alluminio e plastica, snodato con cavo a vista in pvc. Diffusore orientabile a led e interruttore incorporato. Spina con alimentatore.

LED Sorgente luminosa LED 4000 K, 25.000 h di durata.

+ Lampada con dimmer.

+ Lampada con dimmer tattile.



P. 454





Wally

Montatura e paralume in metallo verniciato a polveri con dettagli in metallo nichelato. Struttura a braccio articolato regolabile. Interruttore incorporato sulla testa del paralume. Cavo in pvc. Colori: bianco o nero.



Lampada con interruttore integrato.



265308



265292

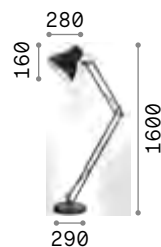

IP20

9,200 Kg / 0,0845 m³
E27 max 1 x 42W

€ 250

265308 ■ Bianco
265292 ■ Nero

3000 K
950 lm

101330 € 8,00



P. 457



Sally

Montatura e paralume in metallo verniciato a polveri con dettagli in metallo nichelato. Struttura a braccio articolato regolabile. Interruttore incorporato sulla testa del paralume. Cavo in pvc. Colori: bianco o nero.



Lampada con interruttore integrato.



265322

265315

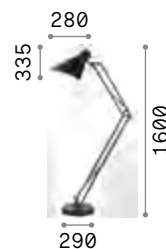

IP20

9,400 Kg / 0,0943 m³
E27 max 1x 42W

€ 250

265322 ■ Bianco
265315 ■ Nero

3000 K
950 lm

101330 € 8,00



P. 457



Polly

Diffusori e base in metallo cromato, alluminio o smaltato nero. Dettagli e raccordi in metallo cromato. Diffusori orientabili.



Lampada con interruttore integrato.

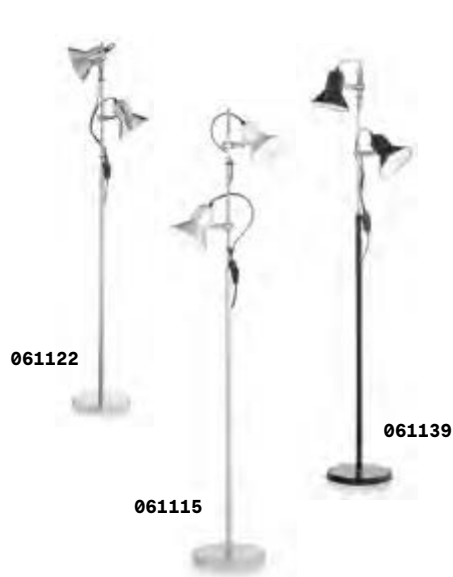

IP20

3,500 Kg / 0,0207 m³
E27 max 2x 60W

€ 120

061122 Cromo
061115 Alluminio
061139 Nero

3000 K
910 lm
119571 € 7,00



Stage

Corpo luce in metallo rifinito con vernice nera opaca. Treppiede con asta telescopica regolabile in altezza. Diffusore orientabile, decorato internamente in foglia oro.



Lampada con interruttore integrato.



5,540 Kg / 0,1163 m³
E27 max 1x60W

€ 400

132778 ■ Oro

3000 K
910 lm

119571 € 7,00



Dorsale

Montatura in metallo rifinito in cromo o con vernice opaca bianca o nera. Braccio a sezione quadrata composto da tre elementi. Paralume in lamina di PVC, disponibile in colore cromo o rivestita in tessuto bianco o nero.



Lampada con interruttore integrato.

046471



041742

046723

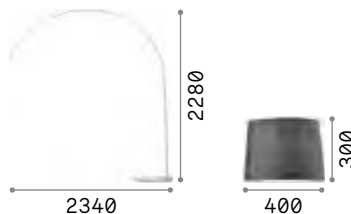
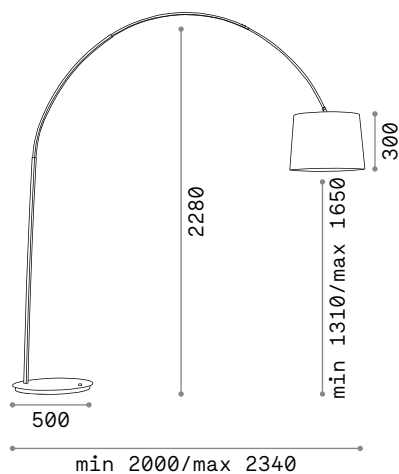

IP20

12,000 Kg / 0,0856 m³
E27 max 1x60W

€ 600

286686 ■ Bianco
286662 ■ Cromo
286679 ■ Nero

0,430 Kg / 0,0708 m³

€ 75

046723 ■ Bianco
041742 ■ Cromo
046471 ■ Nero

3000 K
1020 lm

101347 € 8,50



Daddy

Montatura in metallo. Disponibile in nero e bianco opaco con paralume rivestito in tessuto.



Lampada con interruttore integrato.

110356

110363

400

250

1970

1180

IP20

7,250 Kg / 0,1287 m³
E27 max 1x 60W

€ 340

110356 ■ Bianco
110363 ■ Nero

3000 K
1020 lm

101347 € 8,50



Pagoda

Montatura e base in metallo rifinito con smalto satinato. Paralume a inclinazione regolabile rivestito di tessuto.



Lampada con interruttore integrato.



IP20

11,620 Kg / 0,1755 m³
E27 max 1x60W

€ 390

051741 Bianco
062273 Argento
051765 Nero

3000 K
1020 lm

101347 € 8,50



Eminent

Montatura in metallo verniciato a polveri di colore bianco o nero. Asta in legno naturale. Paralume in pvc rivestito con tessuto. Cavo rivestito in tessuto con interruttore.

ON
OFF Lampada con interruttore integrato.

207582

207599

420

280

2300

1660

IP20

10,610 Kg / 0,1120 m³
E27 max 1 x 60W

€ 525

207582 ■ Bianco
207599 ■ Nero

3000 K
900 lm

101354 € 8,50



Axel

Base e raccordi in metallo verniciato a polveri. Stelo in legno naturale. Paralume regolabile in altezza, in pvc rivestito di tessuto. Cavo in pvc con interruttore. Colori: bianco o nero.



Lampada con interruttore integrato.



272245

282084

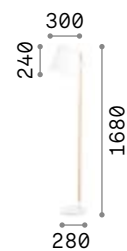

IP20

5,200 Kg / 0,0818 m³
E27 max 1x60W

€ 230

272245 ■ Bianco
282084 ■ Nero

3000 K
1020 lm

101347

€ 8,50



P. 470



Driftwood

Montatura in metallo. Elementi decorativi con rami di legno naturale. Diffusore in lamina di pvc rivestito con tessuto canvas.



Lampada con interruttore integrato.

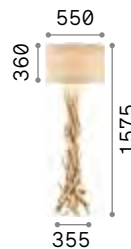

IP20

5,830 Kg / 0,3487 m³
E27 max 1x 60W

€ 645

148939 Legno

2200 K
370 lm

151687 € 5,50

IP20

24,000 Kg / 0,1753 m³
E27 max 2x 60W

€ 720

180946 Legno

2200 K
370 lm

151687 € 5,50



P. 243



P. 478



York

Base in legno naturale con dettagli in metallo. Paralume in lamina di pvc rivestito in tessuto. Cavo esterno in tessuto. Disponibile anche con montatura e paralume bianchi o neri.



Lampada con interruttore integrato.

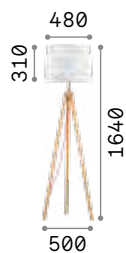

121406

121437

089805



2,810 Kg / 0,0947 m³
E27 max 1x60W

€ 230

121406 ■ Bianco
121437 ■ Nero
089805 ■ Legno



3000 K
1020 lm

101347 € 8,50

Klimt

Treppiede in legno naturale. Paralume in lamina di pvc rivestita in tessuto e con supporto in metallo cromato.



Lampada con interruttore integrato.

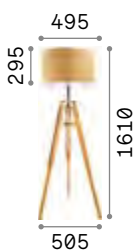

3,870 Kg / 0,1284 m³
E27 max 1x60W

€ 400

137827 ■ Legno



3000 K
1020 lm

101347 € 8,50



Regol

Montatura snodata in metallo.
 Diffusore regolabile ad altezze diverse. Disponibile con finitura nickel satinato e paralume rivestito in tessuto bianco.



Lampada con interruttore integrato.

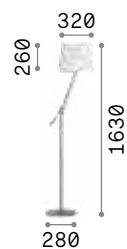

IP20

5,420 Kg / 0,0702 m³
 E27 max 1x60W

€ 280

014609 Bianco

3000 K
 1020 lm

101347 € 8,50



London

Montatura in metallo rifinito in cromo o con vernice opaca bianca o nera. Paralume in lamina di PVC rivestito di tessuto, per la versione cromo in lamina di PVC cromata e semi trasparente.



Lampada con interruttore integrato.



110233

032382

110240

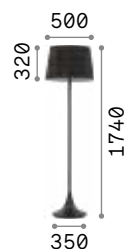

7,120 Kg / 0,1879 m³
E27 max 1x60W

€ 300

110233 Bianco
032382 Cromo
110240 Nero

3000 K
1020 lm

101347

€ 8,50



P. 188



P. 471



Set up ^{new}

Montature in metallo verniciato a polveri o placcato. Paralumi in pvc ignifugo rivestito di tessuto. Colori montature: bianco, nero oppure nichel satinato o ottone spazzolato. Colori paralumi: beige, tortora, bianco o nero.



Lampada con interruttore integrato.



259963 259994 259970 260006 260136 304120 260235 260242



2,640 Kg / 0,0251 m ³ E27 max 1x60W	0,047 Kg / 0,0768 m ³	0,046 Kg / 0,0709 m ³
€ 145	€ 85	€ 65
259963 Bianco 259994 Nickel 259970 Nero 260006 Ottone	260457 Bianco 304625 Tortora ^{new} 270012 Nero 260464 Beige	260136 Bianco 304120 Tortora ^{new} 260235 Nero 260242 Beige

3000 K
900 lm
123899 € 7,00

- P. 192
- P. 290
- P. 424
- P. 476



Cylinder

Base in metallo verniciato bianco opaco. Diffusore in vetro soffiato bianco incamiciato e acidato.



Lampada con interruttore integrato.

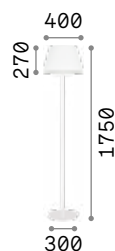

10,010 Kg / 0,1145 m³
E27 max 2x 60W

€ 260

111452 ■ Bianco

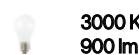

123899

€ 7,00



P. 189

Nordik

Montatura in metallo verniciato nero opaco. Paralume in lamina di PVC dorato rivestito in tessuto nero.



Lampada con interruttore integrato.

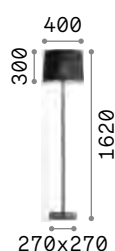

3,620 Kg / 0,0897 m³
E27 max 1x 60W

€ 240

161716 ■ Nero

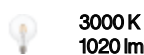

101347

€ 8,50



P. 188



P. 428



P. 472



Luxury

Montatura in metallo rifinita in ottone. Base nera opaca. Paralume in pvc con bordi in tessuto.



Lampada con interruttore integrato.

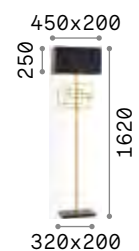

7,440 Kg / 0,2321 m³
E27 max 1x60W

€ 580

201122  Ottone

 3000 K
1020 lm

101347 € 8,50



P. 428



P. 472



Colonna

Montatura in metallo verniciato bianco o nero opaco. Diffusore in acrilico. Cavo in tessuto. Lampadine a LED sostituibili.



Lampadine LED GX53 9W 3000 K incluse. Cod. **123936**



Lampada con interruttore integrato.



177199



177205

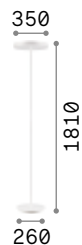

7,740 Kg / 0,0710 m³
GX53 max 4 x 15W

€ 350

177199 ■ Bianco
177205 ■ Nero

3000 K
910 lm

123936 **€ 6,00**



Hilton

Montatura in cromo. Paralume in lamina di PVC rivestita in tessuto. Diffusore in vetro trasparente sabbiato.



Lampada con interruttore integrato.

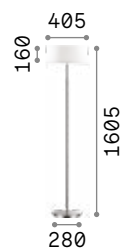

IP20

6,600 Kg / 0,0739 m³
E14 max 2 x 40W

€ 270

075488 Bianco

3000 K
420 lm

101217 € 3,00



P. 191



P. 426



P. 473



Forcola

Montatura e dettagli in metallo cromato. Corpo luce in vetro trasparente soffiato e lavorato a mano. Diffusore in lamina di PVC rivestita di tessuto.



Lampada con interruttore integrato.

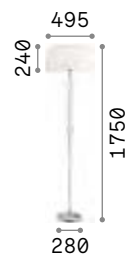

IP20

8,480 Kg / 0,2518 m³
E27 max 1x60W

€ 525

142616 Bianco

3000 K
900 lm

101354 € 8,50



Opera

Montatura in cromo. Paralume in lamina di PVC con riflessi metallizzati e rivestita da fili. Pendagli in cristallo molato.



Lampada con interruttore integrato.

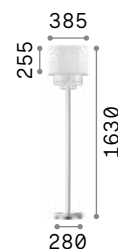

IP20

5,720 Kg / 0,0770 m³
E27 max 1x60W

€ 315

068275 Bianco

3000 K
900 lm

101354

€ 8,50



P. 194



P. 434



P. 483



Queen

Montatura in metallo dorato con elementi decorativi e base in cristallo molato. Paralume in lamina di PVC, rivestita in tessuto con decorazione trapuntata e brillantini dorati.



Lampada con interruttore integrato.



4,900 Kg / 0,0979 m³
E27 max 1x60W

€ 370

077765 Oro



3000 K
1020 lm



101347

€ 8,50

P. 486

Pegaso

Montatura in metallo cromato. Corpo centrale, bobeches e pendagli in cristallo molato. Paralumi in organza.



Lampada con interruttore integrato.

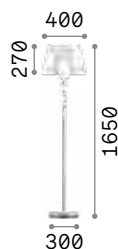

5,450 Kg / 0,0985 m³
E27 max 1x60W

€ 340

059228 Bianco



3000 K
900 Lm



101354

€ 8,50

P. 212

P. 435

P. 487



Firenze

Corpo luce in resina. Bracci e foglie in metallo modellato artigianalmente. Decorato a mano con foglia d'oro e antichizzato.



Lampada con interruttore integrato.



002880



020877

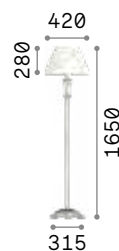

IP20

5,600 Kg / 0,1089 m³
E27 max 1x60W

€ 340

002880 ■ Bianco
020877 ■ Oro

3000 K
1020 lm

101347 € 8,50



P. 238



P. 438



P. 481

























Interni

Sistemi

Indice alfabetico

Arca	534
Ego	548
Fluo	574
Linus	572
Office	588
Slot	598
Steel	584
Tesi	590
Vision	592

Indice icone

 <small>new</small>				
Arca Track 536	Arca Accent 538	Arca Wide 540	Arca Pendant 542	
 <small>new</small>	 <small>new</small>	 <small>new</small>	 <small>new</small>	 <small>new</small>
Ego Single 550	Ego Double 554	Ego Flat 556	Ego Accent 558	Ego Wide 560
 <small>new</small>				
Ego Pendant 562	Linus 572	Fluo Accent 576	Fluo Wide 578	Fluo Biemission 580
				
Steel Accent 584	Steel Wide 584	Office 588		
 <small>new</small>				
Tesi 590	Vision Trimless 594	Vision Trim 596		
	 <small>new</small>			
Slot Recessed 600	Slot Surface 602	Slot Angular 604		

Arca **new**

Sistema lineare in alluminio estruso compatibile con un'ampia scelta di apparecchi illuminanti a fissaggio meccanico. Il sistema è anodizzato e verniciato. Disponibile in colore nero e nelle modalità d'installazione a plafone, a sospensione oppure a incasso a filo in soffitti di cartongesso. Moduli componibili a seconda della disposizione desiderata. Moduli track disponibili anche nella finitura ottone satinato. La sezione della scocca per le versioni a soffitto e a sospensione è larga 42 mm e alta 85 mm, mentre quella per la versione a incasso è larga 86 mm e alta 90 mm. Entrambi i modelli sono disponibili in due lunghezze: 1000 mm e 3000 mm. Possibilità di assemblaggio con diversi moduli sorgente: il modulo WIDE diffondente, il modulo ACCENT con controllo dell'UGR inferiore a 13, i moduli TRACK, TRACK FLAT oppure PENDANT per un'illuminazione SPOT con differenti angoli di emissione. Il modulo CORNER per composizioni angolari. LED integrati, possibilità di temperatura di colore di 3000 K o di 4000 K, binning iniziale ≤ 3 -Step MacAdam, protezione IP20, classe isolamento III, durata utile LED 50.000 h L70B50. L'alimentazione in 48Vdc conferisce grande versatilità e sicurezza, con composizioni reversibili e modificabili all'occorrenza. Sistema adatto per ambienti dove viene richiesta un'illuminazione professionale dal design minimale, come ad esempio UFFICI e spazi COMMERCIALI.

PRO

Prodotto ad alto contenuto tecnologico, elevata qualità dei materiali, destinato ad uso professionale.

UGR

Articolo con UGR <13, <16 (Accent, Pendant).

Sorgente	LED COB / SMD
Driver incluso	No
Driver disponibili	On/Off
MacAdam	SDCM 3
CCT	3000K / 4000K
CRI	$\geq 80 / \geq 90$
UGR	<13, <16 (Accent, Pendant)
Durata LED	50.000h
Classe isolamento	III
IP	20
Materiale	Alluminio
Garanzia	5 anni

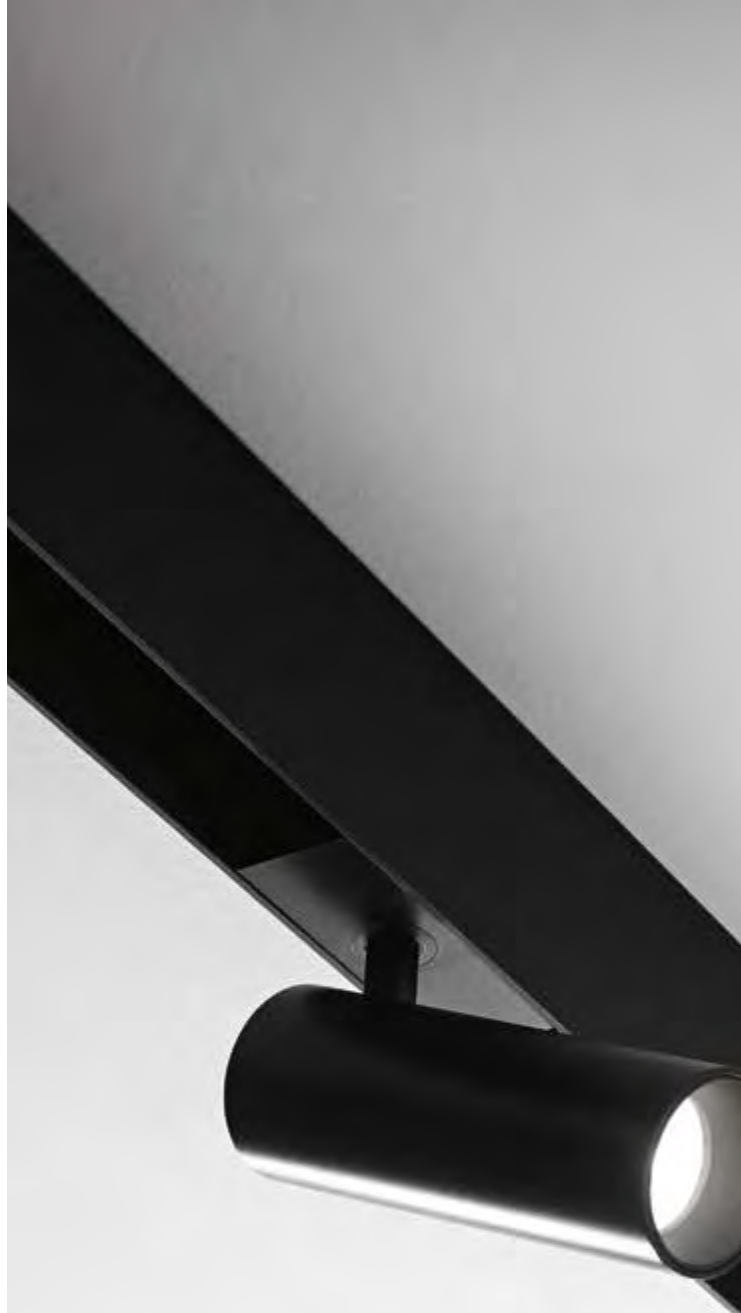



Arca Track

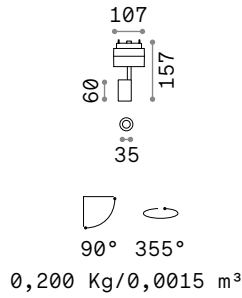

LED SMD CREE

Potenza	Angolo	Lumen	CCT	Finitura	Codice	€
5W	34°	450 lm	3000 K	Nero	222974	109
				Ottone	281995	109
		490 lm	4000 K	Nero	223056	109



LENS

Necessario	Angolo	Codice	€
No	20°	223087	8

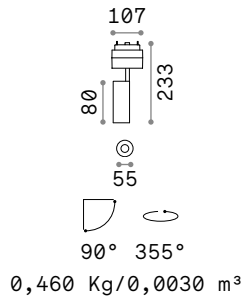

LED COB CITIZEN

Potenza	Angolo	Lumen	CCT	Finitura	Codice	€
14W	36°	1550 lm	3000 K	Nero	222967	140
				Ottone	281988	140
		1650 lm	4000 K	Nero	223049	140



LENS

Necessario	Angolo	Codice	€
No	18°	223094	8

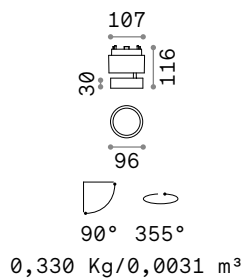

LED COB CITIZEN CRI ≥ 90

Potenza	Angolo	Lumen	CCT	Finitura	Codice	€
9W	36°	1100 lm	3000 K	Nero	290621	140 <small>new</small>
				Ottone	291536	140 <small>new</small>



Light beam: ACCENT

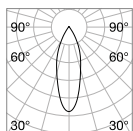

m	lx	Øm
1	553	0,58
2	138	1,16
3	61	1,75
4	35	2,33
5	22	2,91

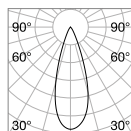

m	lx	Øm
1	2336	0,60
2	584	1,21
3	259	1,81
4	146	2,42
5	93	3,02

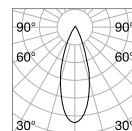

m	lx	Øm
1	2242	0,60
2	560	1,20
3	249	1,80
4	140	2,40
5	90	3,00



CRI ≥ 80 5,5W 34° 4401m 3000K

CRI ≥ 80 14W 36° 14001m 3000K

CRI ≥ 90 9W 36° 11001m 3000K

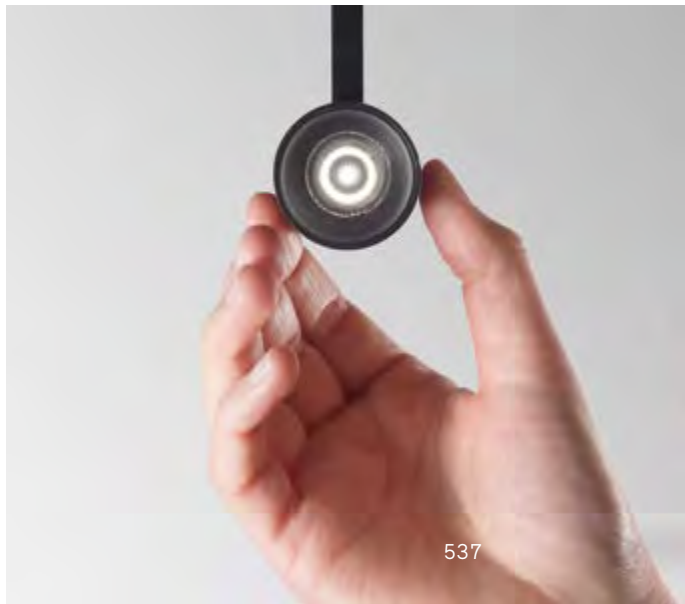

Arca Accent

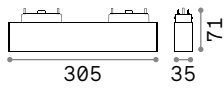

0,440 Kg/0,0026 m³

LED SMD OSRAM UGR <13

Potenza	Angolo	Lumen	CCT	Finitura		Codice	€
15W	35°	2000 lm	3000 K	Nero	■	222929	170
		2100 lm	4000 K	Nero	■	223001	170

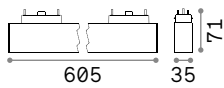

0,700 Kg/0,0087 m³

LED SMD OSRAM UGR <13

Potenza	Angolo	Lumen	CCT	Finitura		Codice	€
29W	35°	3650 lm	3000 K	Nero	■	222936	300
		3950 lm	4000 K	Nero	■	223018	300



Light beam: ACCENT

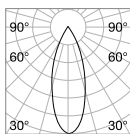

m	lx	Øm
1	2707	0,56
2	676	1,13
3	300	2,26
4	169	2,83
5	108	3,39



CRI≥90 15W 35° 1700lm 3000K

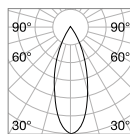

m	lx	Øm
1	4826	0,60
2	1207	1,21
3	536	1,81
4	301	2,42
5	193	3,02



CRI≥90 29W 35° 3200lm 3000K

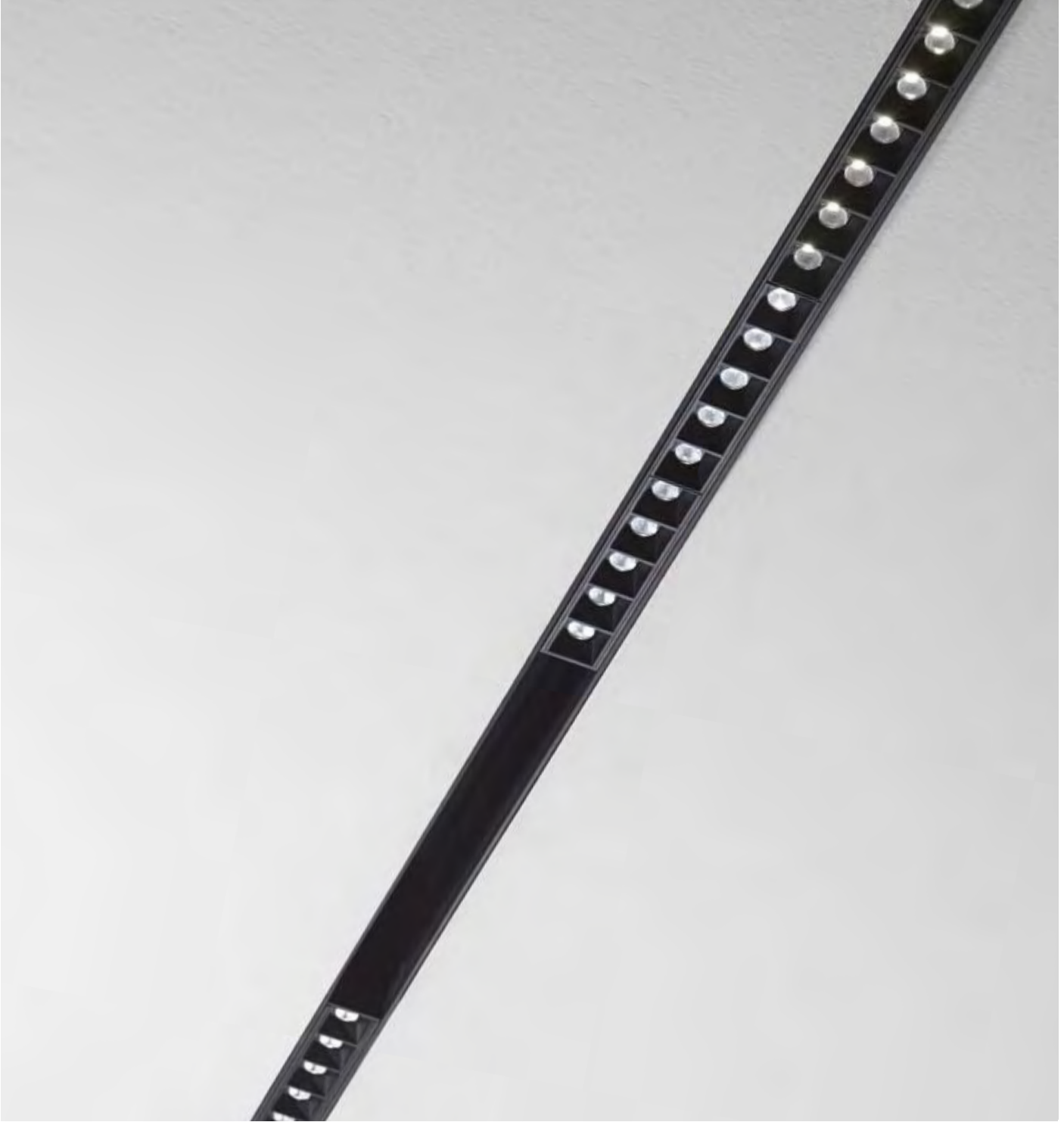

Arca Accent 300 mm



Arca Accent 600 mm



Arca Wide

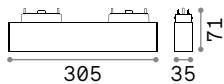
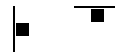

LED SMD SAMSUNG

Potenza	Angolo	Lumen	CCT	Finitura	Codice	€
13W	98°	1900 lm	3000 K	Nero	222943	105
		2000 lm	4000 K	Nero	223025	105

0,410 Kg/0,0025 m³

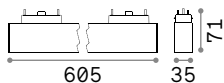

LED SMD SAMSUNG

Potenza	Angolo	Lumen	CCT	Finitura	Codice	€
25W	98°	3800 lm	3000 K	Nero	222950	152
		4050 lm	4000 K	Nero	223032	152

0,700 Kg/0,0087 m³



Light beam: WIDE

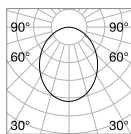

m	lx	Øm
1	203	2,16
2	50	4,33
3	22	6,50
4	12	8,66
5	8	10,83

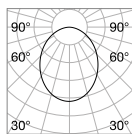
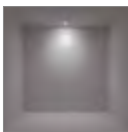

m	lx	Øm
1	440	2,14
2	110	4,28
3	48	6,42
4	27	8,56
5	17	10,70

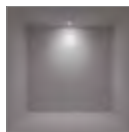

CRI≥80 13W 98° 1950lm 3000K

CRI≥80 25W 98° 4000lm 3000K



Arca Wide 300 mm



Arca Wide 600 mm



Arca Pendant

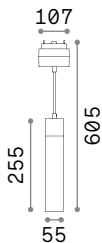

0,740 Kg/0,0056 m³

LED COB CITIZEN UGR <13

Potenza	Angolo	Lumen	CCT	Finitura	Codice	€
15 W	34°	1550 lm	3000 K	Nero	222981	180
		1650 lm	4000 K	Nero	223063	180

Lunghezza cavi 350 mm



LENS

Necessario	Angolo	Codice	€
No	18°	223285	8

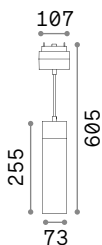

1,080 Kg/0,0056 m³

LED COB CITIZEN UGR <16

Potenza	Angolo	Lumen	CCT	Finitura	Codice	€
21 W	30°	2100 lm	3000 K	Nero	222998	200
		2150 lm	4000 K	Nero	223070	200

Lunghezza cavi 350 mm



LENS

Necessario	Angolo	Codice	€
No	15°	223292	8



Light beam: ACCENT

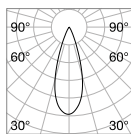

m	lx	cm
1	2410	0,59
2	602	1,19
3	268	1,78
4	151	2,38
5	96	2,98

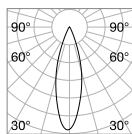
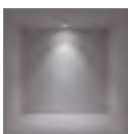

m	lx	cm
1	4788	0,51
2	1197	1,03
3	532	1,55
4	299	2,06
5	191	2,58



CRI≥80 15W 34° 1450lm 3000K

CRI≥80 21W 30° 2650lm 3000K



Arca - Suspension

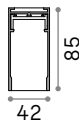
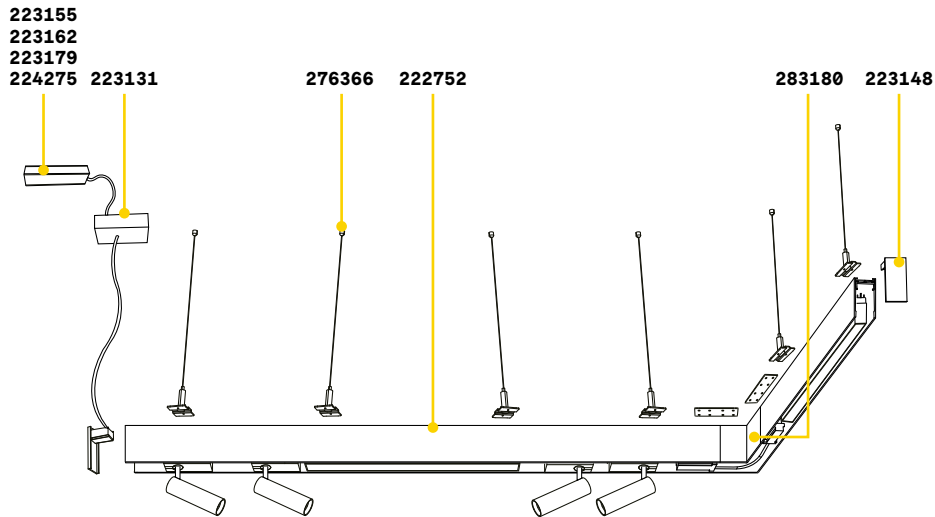

TRACK Lunghezza massima per punto di alimentazione: 25 metri

Lunghezza	Peso	Volume	Finitura	Codice	€
1000 mm	1,34 Kg	0,0273 m ³	Nero	222745	120
3000 mm	4,02 Kg	0,0600 m ³	Nero	222752	325

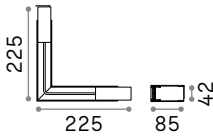

BLINDED CORNER RIGHT - LEFT Optional

Peso	Volume	Finitura	Codice	€
0,79 Kg	0,0090 m ³	Nero	283180	120



	Necessario	Lunghezza cavi	Misura (L x H x P)	Codice	€
LINEAR CONNECTOR	SI - 1 Kit x giunzione		100 x 18 x 38 mm	254944	25
ELECTRIFIED END CAP	SI - 1 kit x punto di alimentaz. max 210W	2150 mm	100 x 2270 x 53 mm	223131	39
END CAP	SI		20 x 85 x 42 mm	223148	16
SINGLE CABLE KIT	SI - 1 Kit x 1000 mm	2000 mm	ø 15 x 2000 mm	276366	13

Arca - Surface

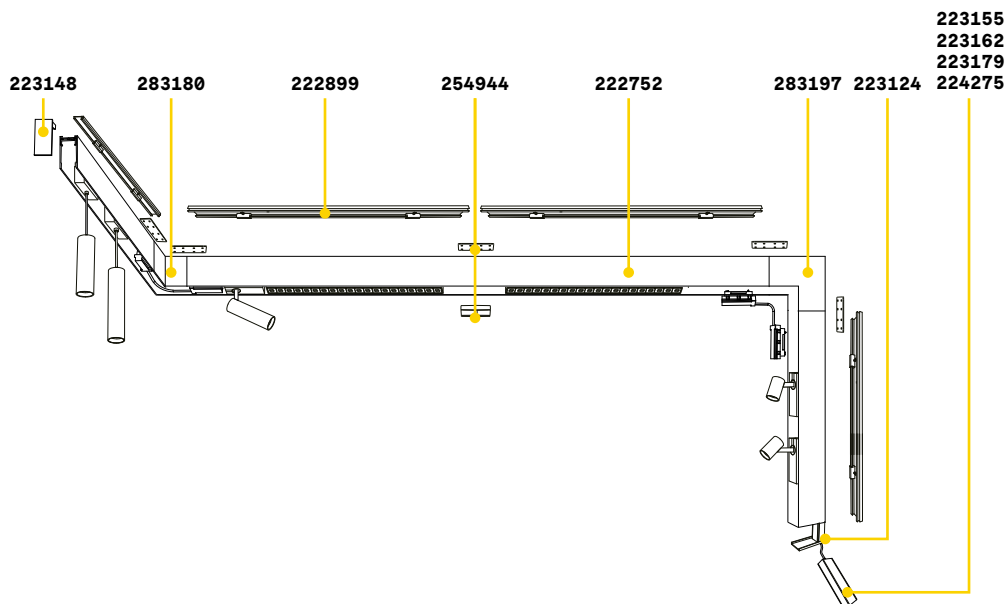

223155
223162
223179
224275

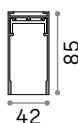

TRACK Lunghezza massima per punto di alimentazione: 25 metri

Lunghezza	Peso	Volume	Finitura	Codice	€
1000 mm	1,34 Kg	0,0273 m ³	Nero	222745	120
3000 mm	4,02 Kg	0,0600 m ³	Nero	222752	325

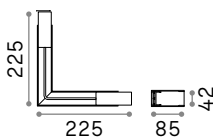

BLINDED CORNER RIGHT - LEFT Optional

Peso	Volume	Finitura	Codice	€
0,79 Kg	0,0090 m ³	Nero	283180	120

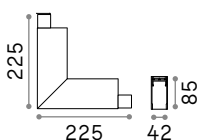

BLINDED CORNER VERTICAL - HORIZONTAL Optional

Peso	Volume	Finitura	Codice	€
0,79 Kg	0,0090 m ³	Nero	283197	120



LINEAR CONNECTOR

ELECTRIFIED END CAP

END CAP

KIT SURFACE

Necessario	Lunghezza cavi	Misura (L x H x P)	Codice	€
SI - 1 Kit x giunzione		100 x 18 x 38 mm	254944	25
SI - 1 kit x punto di alimentaz. max 210W	380 mm	86 x 80 x 42 mm	223124	23
SI		20 x 85 x 42 mm	223148	16
SI - 1 Kit x 1000 mm		1000 x 12 x 42 mm	222899	30

Arca - Recessed

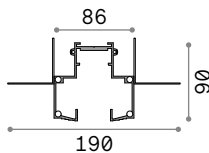
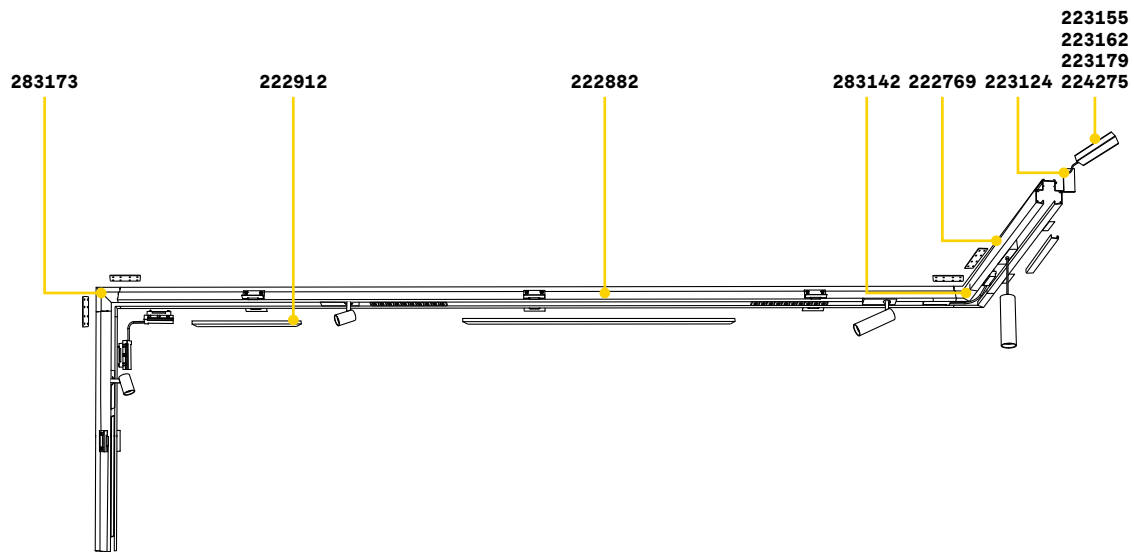

TRACK Kit per montaggio profilo e tappi di chiusura inclusi
Lunghezza massima per punto di alimentazione: 25 metri

Lunghezza	Peso	Volume	Finitura	Codice	€
1000 mm	2,90 Kg	0,0269 m ³	Nero	222769	187
3000 mm	8,70 Kg	0,0617 m ³	Nero	222882	490

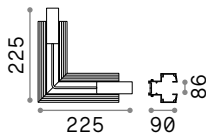

BLINDED CORNER RIGHT - LEFT Optional

Peso	Volume	Finitura	Codice	€
1,12 Kg	0,0090 m ³	Nero	283142	150

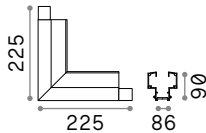

BLINDED CORNER VERTICAL - HORIZONTAL Optional

Peso	Volume	Finitura	Codice	€
1,12 Kg	0,0090 m ³	Nero	283173	150



LINEAR CONNECTOR

Necessario	Lunghezza cavi	Misura (L x H x P)	Codice	€
SI - 1 Kit x giunzione		100 x 18 x 38 mm	254944	25

ELECTRIFIED END CAP

SI - 1 kit x punto di alimentaz. max 210W	380 mm	86 x 80 x 42 mm	223124	23
---	--------	-----------------	--------	----



Arca - Drivers and cover

DRIVER MEANWELL ON/OFF Necessario



Potenza	Output	Classe	Misura (LxHxP)	Codice	€
60 W	48 Vdc	⊕	171x37x62 mm	223155	140
90 W	48 Vdc	⊕	220x37x68 mm	223162	185
150 W	48 Vdc	⊕	228x37x68 mm	223179	205
240 W	48 Vdc	⊕	244x39x68 mm	224275	230

DRIVER BOX Optional



Materiale	Misura (LxHxP)	Colore	Codice	€
Metal	255x55x75 mm	Bianco	302379	25 <small>new</small>
		Nero	302362	25 <small>new</small>
	330x60x80 mm	Bianco	302355	30 <small>new</small>
		Nero	302348	30 <small>new</small>

BLINDED COVER Optional



Materiale	Lunghezza	Colore	Codice	€
PC	990 mm	Nero	222912	8

Ego ^{new}

Sistema lineare composto da un profilo in alluminio estruso ed elementi di illuminazione a fissaggio magnetico con blocco meccanico di sicurezza. Il sistema è disponibile in colore nero, bianco oppure ottone satinato, nella modalità d'installazione a plafone, sospensione e incasso. La sezione del profilo è larga 26 mm e alta 27 mm o 52 mm, disponibile in due lunghezze 1000 mm e 2000 mm. Possibilità di assemblaggio con diversi moduli sorgente componibili a seconda della disposizione desiderata e modificabili all'occorrenza: i moduli TRACK SINGLE, DOUBLE e FLAT SINGLE per un'illuminazione spot, il modulo ACCENT con controllo dell'abbagliamento ($UGR < 19$), il modulo PENDANT TUBE per un'illuminazione localizzata e i moduli WIDE per un'illuminazione diffusa e uniforme. LED integrati con temperatura di colore di 3000 K e CRI 90, protezione IP20, classe isolamento III, alimentazione in 48 Vdc, durata utile LED 50.000 h L70B50; sistema disponibile anche in versione dimmerabile 1-10V o DALI. Ideale per l'illuminazione di piccoli e grandi ambienti dove viene richiesta ampia flessibilità e resa cromatica, ad esempio spazi MUSEALI, COMMERCIALI, RESIDENZIALI e RETAIL.

PRO

Prodotto ad alto contenuto tecnologico, elevata qualità dei materiali, destinato ad uso professionale.

UGR

Articolo con $UGR < 19$ (Accent, Pendant).

Sorgente	LED COB / SMD
Driver incluso	No
Driver disponibili	On/Off
Controllo	1-10V / DALI
MacAdam	SDCM 3
CCT	3000K
CRI	≥ 90
UGR	< 19 (Accent, Pendant)
Durata LED	50.000h
Classe isolamento	III
IP	20
Materiale	Alluminio
Garanzia	5 anni





Ego Track Single



LED SMD OSRAM

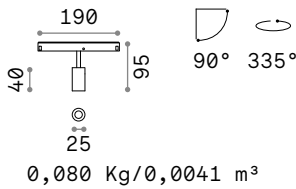

Potenza	Angolo	Lumen	CCT	Controllo	Finitura	Codice	€
3W	30°	190 lm	3000 K	On-Off	Bianco	282978	85
					Nero	257617	85
					Ottone	282039	85
1-10V	30°	190 lm	3000 K	On-Off	Bianco	303673	120 <i>new</i>
					Nero	303666	120 <i>new</i>
DALI	30°	190 lm	3000 K	DALI	Bianco	286402	140
					Nero	286396	140



LED COB CITIZEN

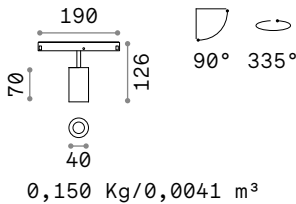

Potenza	Angolo	Lumen	CCT	Controllo	Finitura	Codice	€
8W	30°	730 lm	3000 K	On-Off	Bianco	282985	107
					Nero	257631	107
					Ottone	282046	107
1-10V	30°	730 lm	3000 K	On-Off	Bianco	303697	130 <i>new</i>
					Nero	303680	130 <i>new</i>
DALI	30°	730 lm	3000 K	DALI	Bianco	286426	160
					Nero	286419	160



LED COB CITIZEN

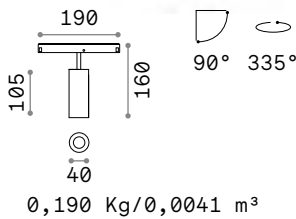

Potenza	Angolo	Lumen	CCT	Controllo	Finitura	Codice	€
12W	30°	1000 lm	3000 K	On-Off	Bianco	282992	115
					Nero	257655	115
					Ottone	282053	115
1-10V	30°	1000 lm	3000 K	On-Off	Bianco	303710	135 <i>new</i>
					Nero	303703	135 <i>new</i>
DALI	30°	1000 lm	3000 K	DALI	Bianco	286440	165
					Nero	286433	165



FILTER HONEYCOMB

Modello	Necessario	Codice	€
Ego 3W	No	260853	5
Ego 8W	No	260860	5
Ego 12W	No	260860	5



Light beam: ACCENT

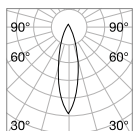

m	lx	øm
1	537	0,46
2	134	0,92
3	60	1,40
4	34	1,80
5	21	2,30

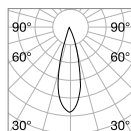

m	lx	øm
1	2393	0,49
2	598	0,98
3	266	1,50
4	150	2,00
5	96	2,50

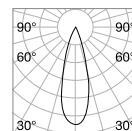

m	lx	øm
1	2877	0,51
2	719	1,00
3	320	1,50
4	180	2,10
5	115	2,60

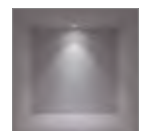

CRI≥90 3W 30° 2301lm 3000K

CRI≥90 8W 30° 7501lm 3000K

CRI≥90 12W 30° 10001lm 3000K

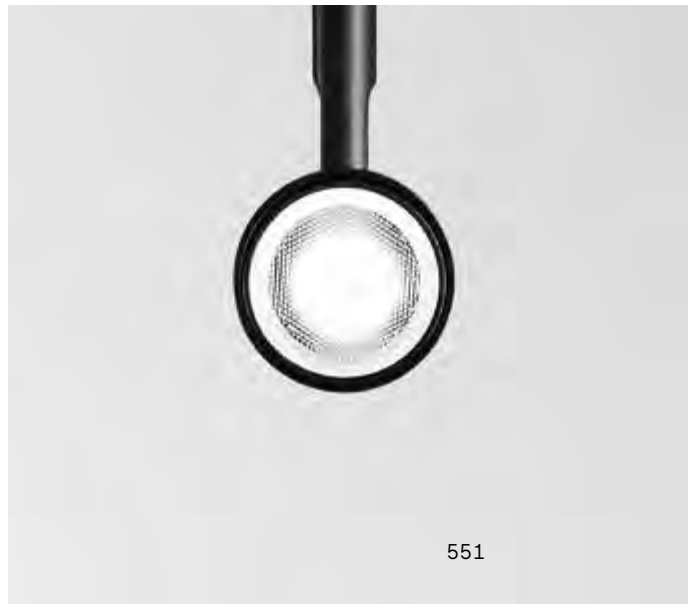

Ego Track Single

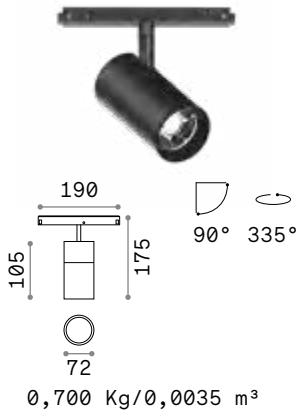

LED COB CITIZEN

Potenza	Angolo	Lumen	CCT	Controllo	Finitura	Codice	€
19W	35°	2200 lm	3000 K	On-Off	Bianco	307558	175 <i>new</i>
					Nero	305608	175 <i>new</i>
				1-10V	Bianco	307527	195 <i>new</i>
					Nero	307510	195 <i>new</i>
				DALI	Bianco	307541	230 <i>new</i>
					Nero	307534	230 <i>new</i>

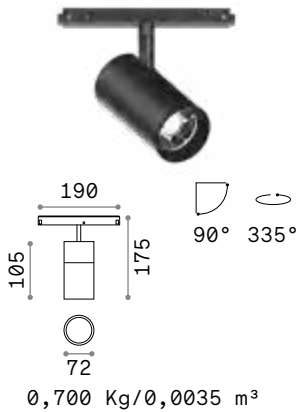

LED COB CITIZEN

Potenza	Angolo	Lumen	CCT	Controllo	Finitura	Codice	€
26W	35°	2950 lm	3000 K	On-Off	Bianco	307602	180 <i>new</i>
					Nero	305615	180 <i>new</i>
				1-10V	Bianco	307572	200 <i>new</i>
					Nero	307565	200 <i>new</i>
				DALI	Bianco	307596	235 <i>new</i>
					Nero	307589	235 <i>new</i>



Light beam: ACCENT

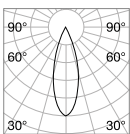

m	lx	Øm
1	4476	0,57
2	1119	1,10
3	497	1,70
4	280	2,30
5	179	2,90

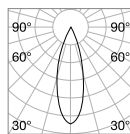

m	lx	Øm
1	6816	0,56
2	1704	1,10
3	757	1,70
4	426	2,20
5	273	2,80



CRI≥90 19W 35° 2200lm 3000K

CRI≥90 26W 35° 2950lm 3000K

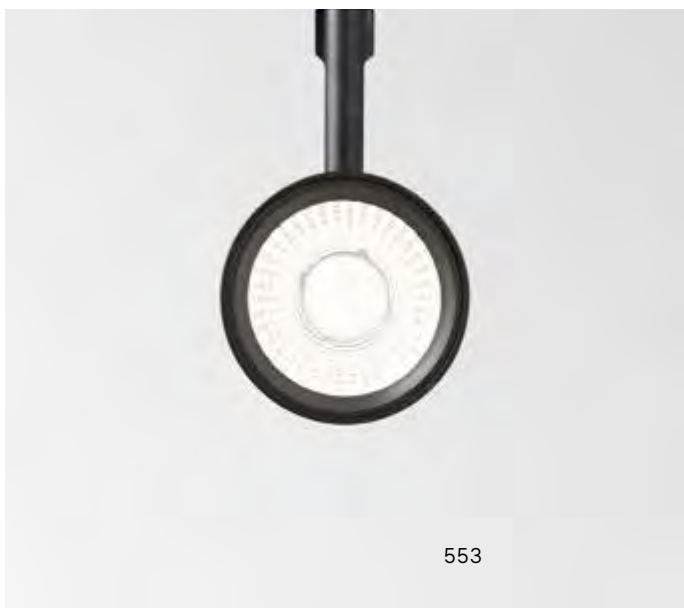

Ego Track Double



LED SMD OSRAM

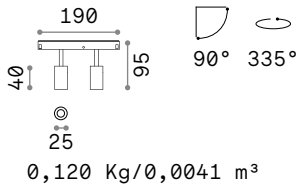

Potenza	Angolo	Lumen	CCT	Controllo	Finitura	Codice	€
5 W	30°	380 lm	3000 K	On-Off	Bianco	282947	120
					Nero	257624	120
					Ottone	282008	120
1-10V	30°	380 lm	3000 K	On-Off	Bianco	303611	145 <i>new</i>
					Nero	303604	145 <i>new</i>
DALI	30°	380 lm	3000 K	DALI	Bianco	286341	170
					Nero	286334	170

LED COB CITIZEN

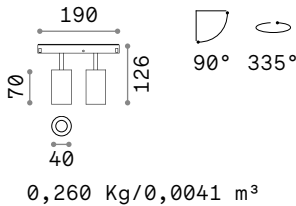

Potenza	Angolo	Lumen	CCT	Controllo	Finitura	Codice	€
16 W	30°	1450 lm	3000 K	On-Off	Bianco	282954	160
					Nero	257648	160
					Ottone	282015	160
1-10V	30°	1450 lm	3000 K	On-Off	Bianco	303635	190 <i>new</i>
					Nero	303628	190 <i>new</i>
DALI	30°	1450 lm	3000 K	DALI	Bianco	286365	210
					Nero	286358	210

LED COB CITIZEN

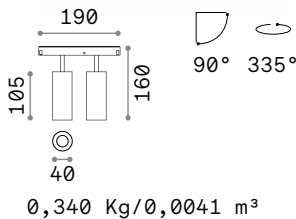

Potenza	Angolo	Lumen	CCT	Controllo	Finitura	Codice	€
24 W	30°	2000 lm	3000 K	On-Off	Bianco	282961	170
					Nero	257662	170
					Ottone	282022	170
1-10V	30°	2000 lm	3000 K	On-Off	Bianco	303659	195 <i>new</i>
					Nero	303642	195 <i>new</i>
DALI	30°	2000 lm	3000 K	DALI	Bianco	286389	220
					Nero	286372	220



FILTER HONEYCOMB

Modello	Necessario	Codice	€
Ego 5 W	No	260853	5
Ego 16 W	No	260860	5
Ego 24 W	No	260860	5



Light beam: ACCENT

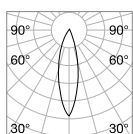

m	lx	Øm
1	508	0,46
2	127	0,92
3	56	1,40
4	32	2,80
5	20	2,30



CRI≥90 5W 30° 4501m 3000K

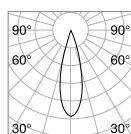

m	lx	Øm
1	2451	0,49
2	613	1,98
3	272	1,50
4	153	2,00
5	98	2,50



CRI≥90 16W 30° 15001m 3000K

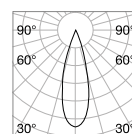

m	lx	Øm
1	3051	0,51
2	763	1,00
3	339	1,50
4	191	2,10
5	122	2,60

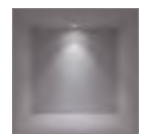

CRI≥90 24W 30° 22001m 3000K

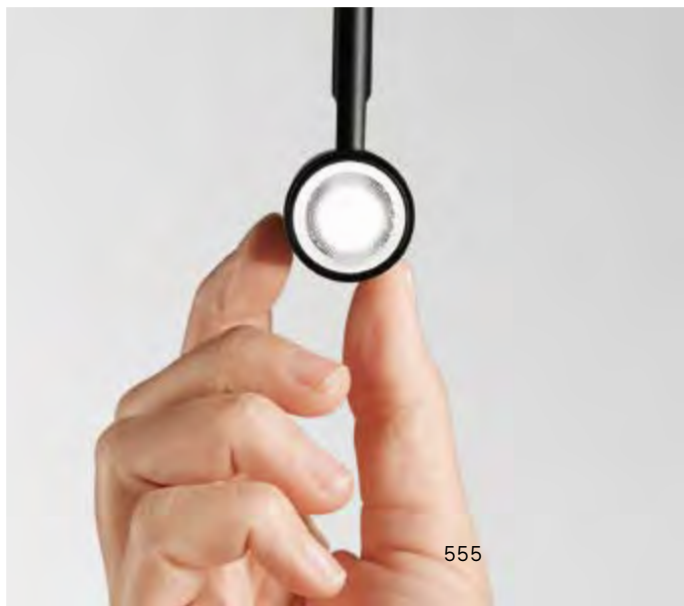

Ego Track Flat

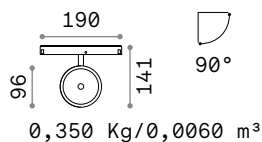

LED COB CITIZEN

Potenza	Angolo	Lumen	CCT	Controllo	Finitura	Codice	€
9W	36°	1100 lm	3000 K	On-Off	Bianco	300504	125 <i>new</i>
					Nero	290614	125 <i>new</i>
					Ottone	300511	125 <i>new</i>
				1-10V	Bianco	303741	140 <i>new</i>
					Nero	303727	140 <i>new</i>
					Ottone	303734	140 <i>new</i>
DALI	Bianco	300535	175 <i>new</i>				
	Nero	300528	175 <i>new</i>				
					Ottone	300542	175 <i>new</i>



Light beam: ACCENT

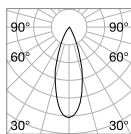

m	lx	Øm
1	2242	0,60
2	560	1,20
3	249	1,80
4	140	2,40
5	90	3,00

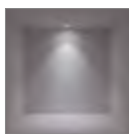

CRI≥90 9W 36° 1100lm 3000K

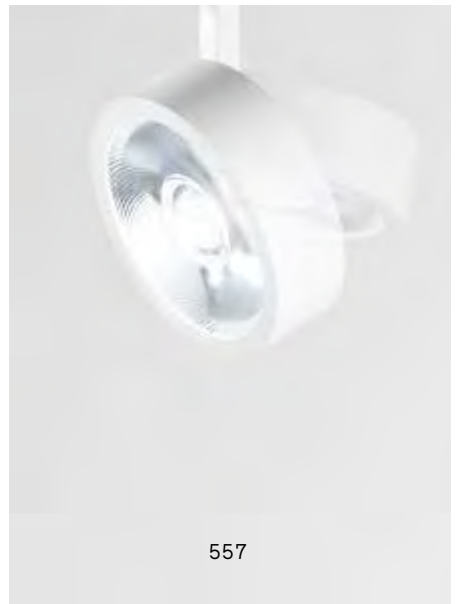
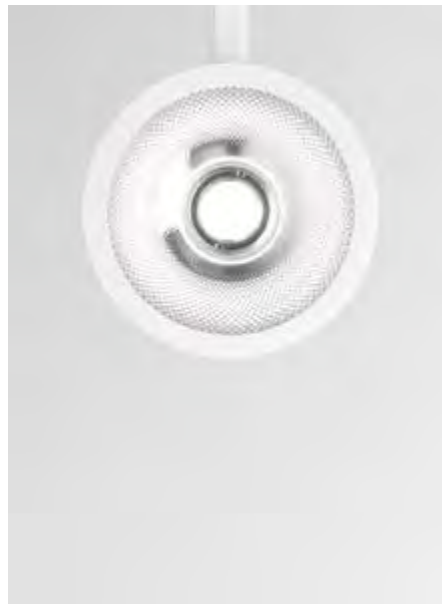

Ego Accent

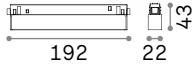

0,140 Kg/0,0013 m³

LED SMD OSRAM UGR <19

Potenza	Angolo	Lumen	CCT	Controllo	Finitura	Codice	€
7 W	35°	700 lm	3000 K	On-Off	Bianco	282633	115
					Nero	257792	115
				1-10V	Bianco	303505	155 <i>new</i>
					Nero	303499	155 <i>new</i>
				DALI	Bianco	286068	170
					Nero	286051	170

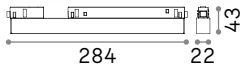

0,210 Kg/0,0019 m³

LED SMD OSRAM UGR <19

Potenza	Angolo	Lumen	CCT	Controllo	Finitura	Codice	€
13 W	35°	1300 lm	3000 K	On-Off	Bianco	282640	165
					Nero	257686	165
				1-10V	Bianco	303529	190 <i>new</i>
					Nero	303512	190 <i>new</i>
				DALI	Bianco	286082	230
					Nero	286075	230

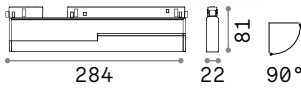

0,470 Kg/0,0031 m³

LED SMD OSRAM UGR <19

Potenza	Angolo	Lumen	CCT	Controllo	Finitura	Codice	€
13 W	35°	1300 lm	3000 K	On-Off	Bianco	282718	200
					Nero	257846	200
				1-10V	Bianco	303543	225 <i>new</i>
					Nero	303536	225 <i>new</i>
				DALI	Bianco	286105	250
					Nero	286099	250



Light beam: ACCENT

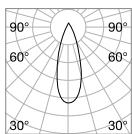

m	lx	Øm
1	3121	0,61
2	780	1,20
3	347	1,80
4	195	2,40
5	125	3,00



CRI≥90 13W 35° 1500lm 3000K



EGO FLEXIBLE ACCENT

Ego Accent 192 mm



Ego Accent 284 mm



Ego Wide

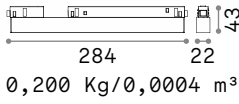

LED SMD SAMSUNG

Potenza	Angolo	Lumen	CCT	Controllo	Finitura	Codice	€
7 W	110°	820 lm	3000 K	On-Off	Bianco	283029	85
					Nero	257709	85
				1-10V	Bianco	303796	130 <i>new</i>
					Nero	303789	130 <i>new</i>
				DALI	Bianco	286501	145
					Nero	286495	145

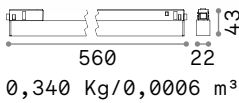

LED SMD SAMSUNG

Potenza	Angolo	Lumen	CCT	Controllo	Finitura	Codice	€
13 W	110°	1650 lm	3000 K	On-Off	Bianco	283036	118
					Nero	257716	118
				1-10V	Bianco	303819	165 <i>new</i>
					Nero	303802	165 <i>new</i>
				DALI	Bianco	286525	170
					Nero	286518	170

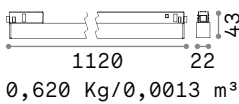

LED SMD SAMSUNG

Potenza	Angolo	Lumen	CCT	Controllo	Finitura	Codice	€
26 W	110°	3300 lm	3000 K	On-Off	Bianco	283043	170
					Nero	257730	170
				1-10V	Bianco	303833	200 <i>new</i>
					Nero	303826	200 <i>new</i>
				DALI	Bianco	286549	215
					Nero	286532	215



LED SMD SAMSUNG

Potenza	Angolo	Lumen	CCT	Controllo	Finitura	Codice	€
7 W	110°	820 lm	3000 K	On-Off	Bianco	282725	135
					Nero	257839	135
				1-10V	Bianco	303567	165 <i>new</i>
					Nero	303550	165 <i>new</i>
				DALI	Bianco	286129	185
					Nero	286112	185



Light beam: WIDE

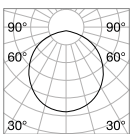

m	lx	Øm
1	619	2,50
2	155	4,90
3	69	7,40
4	39	9,80
5	25	12,00

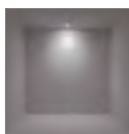

CRI≥90 26W 110° 2400lm 3000K



EGO FLEXIBLE WIDE

Ego Wide 284 mm



Ego Wide 560 mm



Ego Wide 1120 mm



Ego Pendant

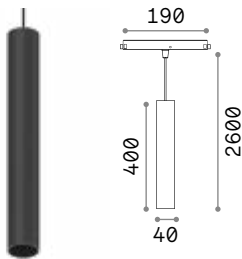

0,540 Kg/0,0038 m³

LED COB CITIZEN UGR <19

Potenza	Angolo	Lumen	CCT	Controllo	Finitura	Codice	€
12 W	30°	1000 lm	3000 K	On-Off	Bianco	282879	165
					Nero	257747	165
					Ottone	283852	165 <i>new</i>
				1-10V	Bianco	303598	200 <i>new</i>
					Nero	303574	200 <i>new</i>
					Ottone	303581	200 <i>new</i>
				DALI	Bianco	286327	215
					Nero	286310	215
					Ottone	300498	215 <i>new</i>



Light beam: ACCENT

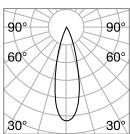

m	lx	Øm
1	2877	0,51
2	719	1,00
3	320	1,50
4	180	2,10
5	115	2,60



CRI≥90 12W 30° 1000lm 3000K



Ego - Suspension Low

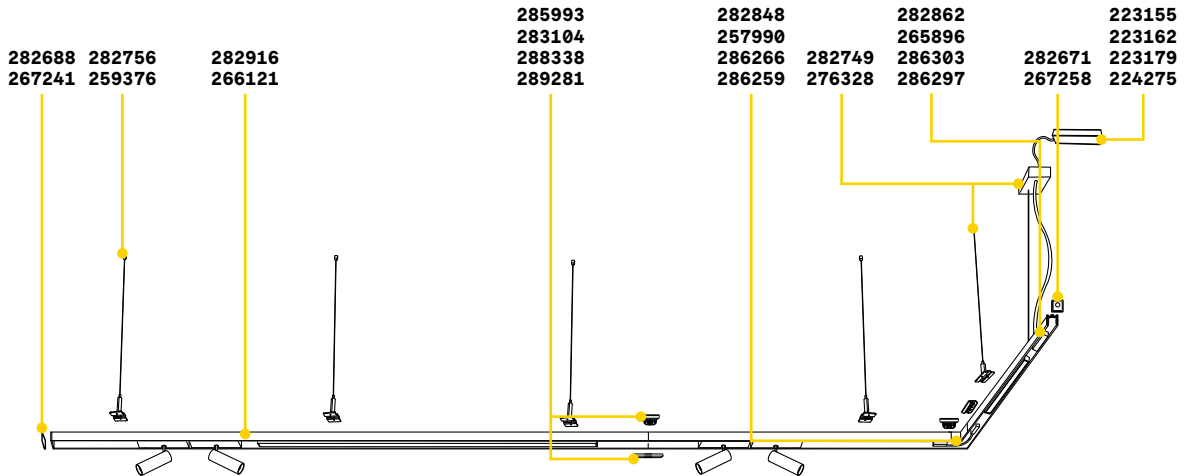

TRACK LOW Lunghezza massima per punto di alimentazione: 25 metri

Lunghezza	Peso	Volume	Finitura	Codice	€
1000 mm	0,68 Kg	0,0013 m ³	Bianco	282909	57
			Nero	257877	57
2000 mm	1,36 Kg	0,0026 m ³	Bianco	282916	115
			Nero	266121	115

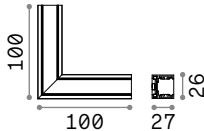

CONNECTOR HORIZONTAL LOW Optional

Peso	Volume	Controllo	Finitura	Codice	€
0,07 Kg	0,0015 m ³	On-Off 1-10V / DALI	Bianco	282848	75
			Nero	257990	75
			Bianco	286266	85
			Nero	286259	85



END CAP NO HOLE

END CAP WITH HOLE

SUSPENSION KIT

KIT SINGLE CABLE

Necessario	Misura (L x H x P)	Finitura	Codice	€
SI	26 x 11 x 27 mm	Bianco	282688	5
		Nero	267241	5
SI	26 x 11 x 27 mm	Bianco	282671	5
		Nero	267258	5
SI - 1 kit x punto di alimentaz. max 210W	2000 mm	Bianco	282749	46
		Nero	276328	46
SI - 1 kit x 900 mm	2000 mm	Bianco	282756	15
		Nero	259376	15

Ego - Suspension High

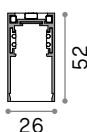
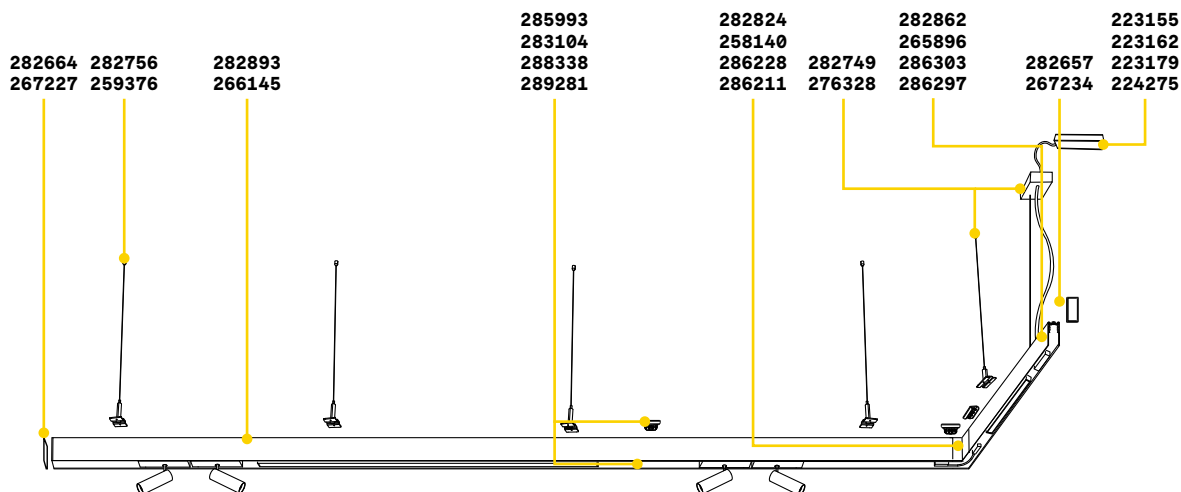

TRACK HIGH Lunghezza massima per punto di alimentazione: 25 metri

Lunghezza	Peso	Volume	Finitura	Codice	€
1000 mm	0,80 Kg	0,0023 m³	Bianco	282886	62
			Nero	258027	62
2000 mm	1,60 Kg	0,0046 m³	Bianco	282893	125
			Nero	266145	125

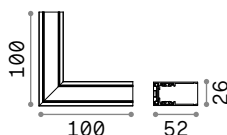

CONNECTOR HORIZONTAL HIGH Optional

Peso	Volume	Controllo	Finitura	Codice	€
0,10 Kg	0,0015 m³	On-Off 1-10V / DALI	Bianco	282824	75
			Nero	258140	75
			Bianco	286228	85
			Nero	286211	85



END CAP NO HOLE

END CAP WITH HOLE

SUSPENSION KIT

KIT SINGLE CABLE

Necessario	Misura (L x H x P)	Finitura	Codice	€
SI	26 x 11 x 52 mm	Bianco	282664	5
		Nero	267227	5
SI	26 x 11 x 52 mm	Bianco	282657	5
		Nero	267234	5
SI - 1 kit x punto di alimentaz. max 210W	2000 mm	Bianco	282749	46
		Nero	276328	46
SI - 1 kit x 900 mm	2000 mm	Bianco	282756	15
		Nero	259376	15

Ego - Surface Low

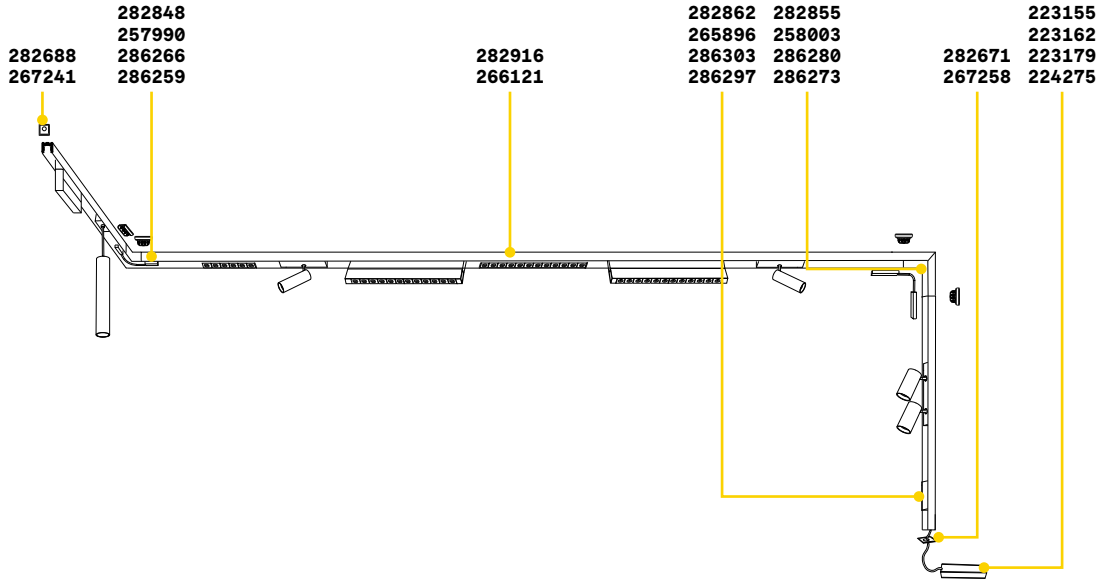

TRACK LOW Kit di montaggio non necessario, fissaggio diretto a soffitto
Lunghezza massima per punto di alimentazione: 25 metri



Lunghezza	Peso	Volume	Finitura	Codice	€
1000 mm	0,68 Kg	0,0013 m ³	Bianco	282909	57
			Nero	257877	57
2000 mm	1,36 Kg	0,0026 m ³	Bianco	282916	115
			Nero	266121	115

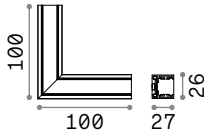

CONNECTOR HORIZONTAL LOW Optional

Peso	Volume	Controllo	Finitura	Codice	€
0,07 Kg	0,0015 m ³	On-Off	Bianco	282848	75
			Nero	257990	75
		DALI	Bianco	286266	85
			Nero	286259	85

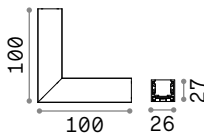

CONNECTOR VERTICAL LOW Optional

Peso	Volume	Controllo	Finitura	Codice	€
0,07 Kg	0,0015 m ³	On-Off	Bianco	282855	75
			Nero	258003	75
		1-10V / DALI	Bianco	286280	85
			Nero	286273	85



END CAP NO HOLE



END CAP WITH HOLE

Necessario	Misura (L x H x P)	Finitura	Codice	€
SI	26 x 11 x 27 mm	Bianco	282688	5
		Nero	267241	5
SI	26 x 11 x 27 mm	Bianco	282671	5
		Nero	267258	5

Ego - Surface High

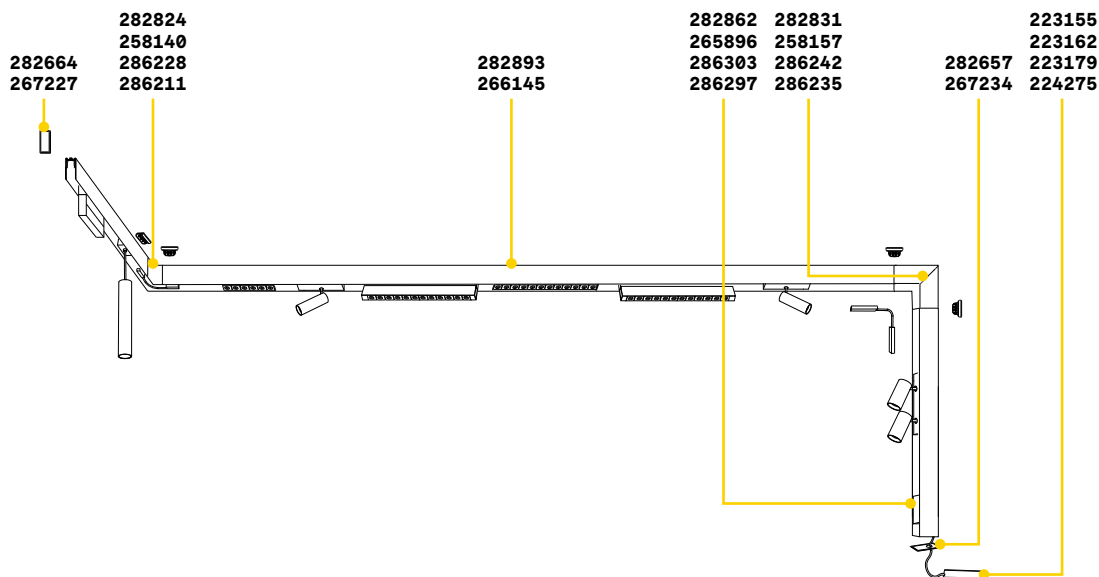

TRACK HIGH Kit di montaggio non necessario, fissaggio diretto a soffitto
Lunghezza massima per punto di alimentazione: 25 metri

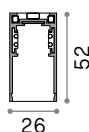

Lunghezza	Peso	Volume	Finitura	Codice	€
1000 mm	0,80 Kg	0,0023 m³	Bianco	282886	62
			Nero	258027	62
2000 mm	1,60 Kg	0,0046 m³	Bianco	282893	125
			Nero	266145	125

CONNECTOR HORIZONTAL HIGH Optional

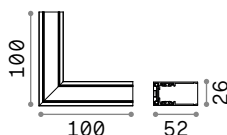

Peso	Volume	Controllo	Finitura	Codice	€
0,10 Kg	0,0015 m³	On-Off	Bianco	282824	75
			Nero	258140	75
		1-10V / DALI	Bianco	286228	85
			Nero	286211	85

CONNECTOR VERTICAL HIGH Optional

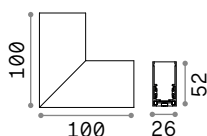

Peso	Volume	Controllo	Finitura	Codice	€
0,10 Kg	0,0015 m³	On-Off	Bianco	282831	75
			Nero	258157	75
		1-10V / DALI	Bianco	286242	85
			Nero	286235	85



END CAP NO HOLE

END CAP WITH HOLE

Necessario	Misura (LxHxP)	Finitura	Codice	€
SI	26 x 11 x 52 mm	Bianco	282664	5
		Nero	267227	5
SI	26 x 11 x 52 mm	Bianco	282657	5
		Nero	267234	5

Ego - Recessed

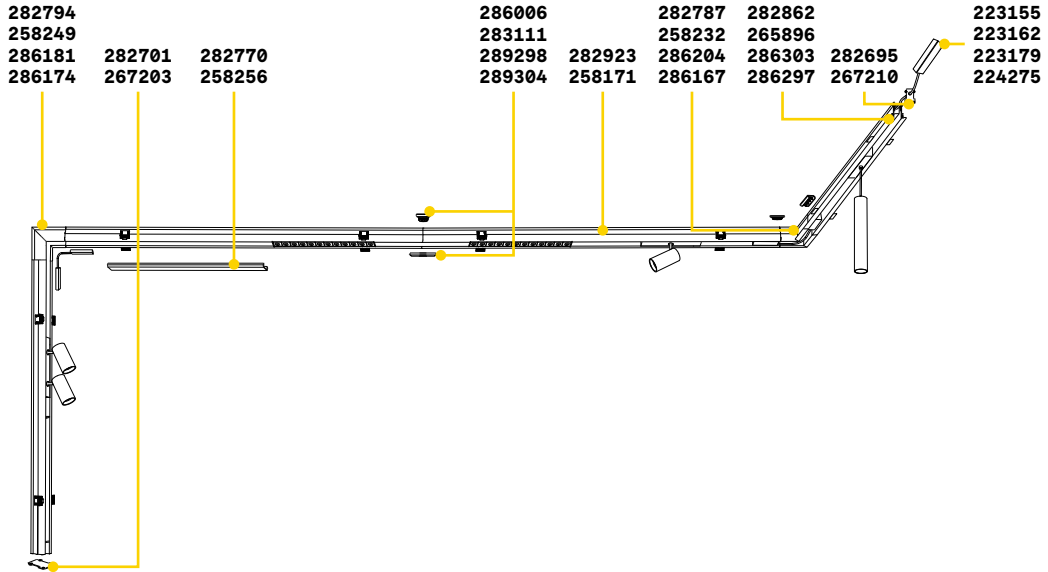

TRACK Kit per montaggio profilo incluso

Lunghezza massima per punto di alimentazione: 25 metri

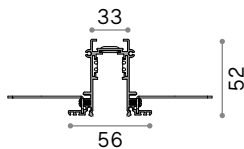

Lunghezza	Peso	Volume	Finitura	Codice	€
1000 mm	1,13 Kg	0,0039 m ³	Bianco	282923	71
			Nero	258171	71
2000 mm	2,26 Kg	0,0078 m ³	Bianco	282930	150
			Nero	266183	150

CONNECTOR HORIZONTAL Optional

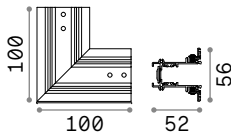

Peso	Volume	Controllo	Finitura	Codice	€	
0,13 Kg	0,0015 m ³	On-Off	Bianco	282787	75	
			Nero	258232	75	
			1-10V / DALI	Bianco	286204	95
			Nero	286167	95	

CONNECTOR VERTICAL 90° Optional

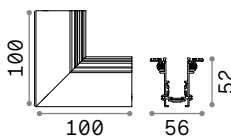

Peso	Volume	Controllo	Finitura	Codice	€	
0,10 Kg	0,0015 m ³	On-Off	Bianco	282794	75	
			Nero	258249	75	
			1-10V / DALI	Bianco	286181	95
			Nero	286174	95	

CONNECTOR VERTICAL 270° Optional

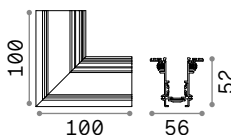

Peso	Volume	Controllo	Finitura	Codice	€	
0,14 Kg	0,0015 m ³	On-Off	Bianco	282800	75	
			Nero	259413	75	
			1-10V / DALI	Bianco	286150	95
			Nero	286198	95	

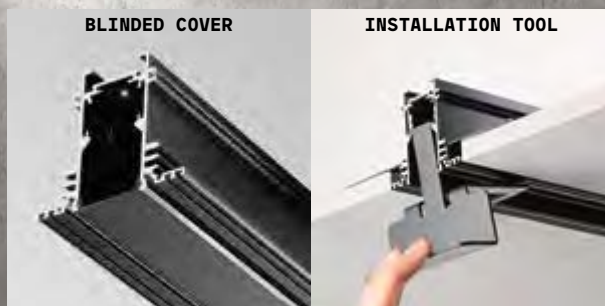

END CAP NO HOLE

END CAP WITH HOLE

BLINDED COVER

INSTALLATION TOOL

Necessario	Misura (LxHxP)	Finitura	Codice	€
SI	36 x 4 x 52 mm	Bianco	282701	5
		Nero	267203	5
SI	36 x 4 x 52 mm	Bianco	282695	5
		Nero	267210	5
No	1000 x 5 x 24 mm	Bianco	282770	15
		Nero	258256	15
No		Nero	292922	26 <small>new</small>

Ego - Connectors and drivers

SUSPENSION AND SURFACE LINEAR CONNECTOR

Necessario - 1 Kit x giunzione lineare

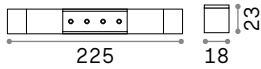

Peso	Volume	Controllo	Finitura	Codice	€
0,16 Kg	0,0005 m ³	On-Off	Bianco	285993	45
			Nero	283104	45
		1-10V / DALI	Bianco	288338	50
			Nero	289281	50

RECESSED LINEAR CONNECTOR

Necessario - 1 Kit x giunzione lineare

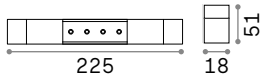

Peso	Volume	Controllo	Finitura	Codice	€
0,16 Kg	0,0005 m ³	On-Off	Bianco	286006	45
			Nero	283111	45
		1-10V / DALI	Bianco	289298	50
			Nero	289304	50

MAIN CONNECTOR

Necessario - 1 Kit x unto di alimentaz. max 210W

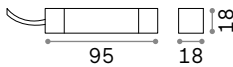

Lunghezza cavo 2000 mm

Peso	Volume	Controllo	Finitura	Codice	€
0,12 Kg	0,0005 m ³	On-Off	Bianco	282862	36
			Nero	265896	36
		1-10V / DALI	Bianco	286303	43
			Nero	286297	43

DRIVER MEANWELL Necessario



Potenza	Output	Classe	Misura (L x H x P)	Codice	€
60 W	48 Vdc	⊕	171x37x62 mm	223155	140
90 W	48 Vdc	⊕	220x37x68 mm	223162	185
150 W	48 Vdc	⊕	228x37x68 mm	223179	205
240 W	48 Vdc	⊕	244x39x68 mm	224275	230

MAGNETIC DRIVER Necessario - Lunghezza cavo 2000 mm



Potenza	Output	Classe	Misura (L x H x P)	Codice	€
100 W	48 Vdc	⊕	297x20x16 mm	296302	80 new

DRIVER BOX Optional



Materiale	Misura (L x H x P)	Colore	Codice	€
Metal	255x55x75 mm	Bianco	302379	25 new
		Nero	302362	25 new
	330x60x80 mm	Bianco	302355	30 new
		Nero	302348	30 new



PROFILE LOW



PROFILE HIGH



Linus



Lampada lineare in alluminio con illuminazione diretta e indiretta. La lampada è modulare e può essere proposta singolarmente oppure in linea continua. LED integrati; binning iniziale ≤ 3-Step MacAdam; CRI ≥ 80; protezione IP20, classe isolamento I. Alimentatore dimmerabile 1-10V integrato di serie.

Sorgente	LED SMD	Durata LED	50.000 h
Potenza	32W	Classe	I
Driver incluso	1-10V	isolamento	
Driver disponibili	No	IP	20
MacAdam	SDCM 3	Materiale	Alluminio
CCT	3000 K/ 4000 K	Garanzia	5 anni
CRI	≥80		

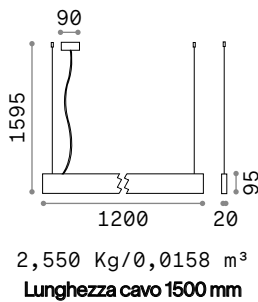

LED SMD Up-light inclusa - Driver 1-10V incluso

Potenza	Angolo	Lumen	CCT	Finitura	Codice	€
32 W	104°	3450 lm	3000 K	Bianco	241968	220
				Nero	241975	220
		3600 lm	4000 K	Bianco	268231	220
				Nero	268217	220

UP-LIGHT INFO

Potenza	Angolo	Lumen	CCT
32 W	104°	3450 lm	3000 K
		3600 lm	4000 K

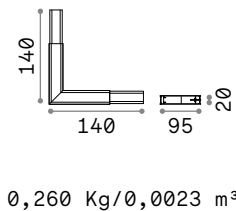

CORNER Optional

Potenza	Angolo	Lumen	CCT	Finitura	Codice	€
4 W	104°	430 lm	3000 K	Bianco	241999	46
				Nero	242002	46
		450 lm	4000 K	Bianco	268149	46
				Nero	268118	46



STRUCTURE CONNECTOR

Necessario	Codice	€
SI - 1Kit x giunzione	241982	6



Light beam: **BI-EMISSION**
WIDE

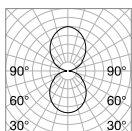

m	lx	Øm
1	572	2,56
2	143	5,12
3	64	7,68
4	36	10,24
5	23	12,80



CRI≥80 32W 104° 3450lm 3000K





Fluo

Sistema lineare di lampade con scocca in alluminio estruso di sezione larga 50 mm e alta 80 mm. Moduli disponibili in due lunghezze: 1200 mm e 1800 mm, componibili tra loro a seconda della disposizione desiderata. Il sistema è disponibile con tre diverse configurazioni: il modello WIDE diffondente, il modello BI-EMISSION con componente luminosa per l'illuminazione indiretta e il modello ACCENT con controllo dell'abbagliamento ($UGR < 13$); LED integrati, possibilità di temperatura di colore di 3000 K o di 4000 K; binning iniziale ≤ 3 -Step MacAdam; protezione IP 20, classe isolamento I; durata utile LED 50.000 h L70B50. Il sistema è disponibile nei colori alluminio anodizzato, bianco, nero e nelle possibili modalità d'installazione singola o in linea continua, per applicazione a plafone, a sospensione oppure a incasso a filo in soffitti di cartongesso. Driver incluso, integrato nel corpo illuminante, disponibile in versione dimmerabile 1-10V, DALI e Push. Sistema adatto per ambienti dove è richiesta un'illuminazione professionale dal design minimale, ad esempio UFFICI e spazi COMMERCIALI.

PRO

Prodotto ad alto contenuto tecnologico, elevata qualità dei materiali, destinato ad uso professionale.

UGR

Articolo con $UGR < 13$ (Accent).

Sorgente	LED COB / SMD
Driver incluso	On/Off
Driver disponibili	1-10V / DALI
MacAdam	SDCM 3
Ottica	Accent/Wide/Bi-Emission
CCT	3000 K / 4000 K
CRI	≥ 83
UGR	< 13 (Accent)
Durata LED	50.000 h
Classe isolamento	I
IP	20
Materiale	Alluminio
Garanzia	5 anni





Fluo Accent

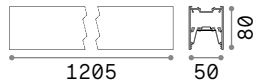
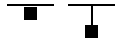

2,760 Kg/0,0183 m³
Lunghezza cavo 1800 mm

LED SMD OSRAM Driver TRIDONIC ON/OFF incluso - UGR <13

Potenza	Angolo	Lumen	CCT	Finitura	Codice	€
30 W	30°	2750 lm	3000 K	Alluminio	192635	360
				Bianco	192611	360
				Nero	192581	360
		2900 lm	4000 K	Alluminio	192574	360
				Bianco	192543	360
				Nero	192529	360

DIMMABLE DRIVER* Optional

	Potenza	Output	Misura (LxHxP)	Codice	€
1-10V	39 W	700 mA	280x21x30 mm	216416	128
DALI/Push	38 W	700 mA	280x21x30 mm	216270	145

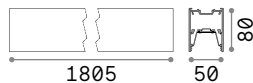

3,860 Kg/0,0269 m³
Lunghezza cavo 1800 mm

LED SMD OSRAM Driver TRIDONIC ON/OFF incluso - UGR <13

Potenza	Angolo	Lumen	CCT	Finitura	Codice	€
30 W	30°	2750 lm	3000 K	Alluminio	192512	430
				Bianco	192499	430
				Nero	192475	430
		2900 lm	4000 K	Alluminio	192451	430
				Bianco	192444	430
				Nero	192420	430

DIMMABLE DRIVER* Optional

	Potenza	Output	Misura (LxHxP)	Codice	€
1-10V	39 W	700 mA	280x21x30 mm	216416	128
DALI/Push	38 W	700 mA	280x21x30 mm	216270	145

MOUNTING KIT Necessario - Pagina 583



Light beam: ACCENT

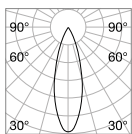

m	lx	Øm
1	8264	0,48
2	2066	0,96
3	918	1,45
4	516	1,93
5	330	2,42



CRI≥83 30W 30° 3300lm 4000K

* Gli alimentatori dimmerabili devono essere ordinati contestualmente al prodotto e verranno già inclusi all'interno degli apparecchi in sostituzione degli alimentatori on-off. La connessione in linea è disponibile soltanto per le versioni on-off dei prodotti.



Fiuo Accent 1200

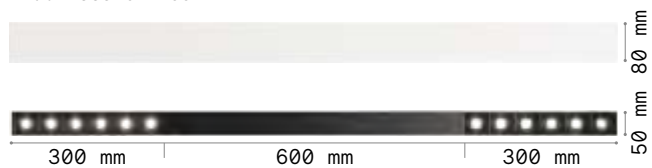

Fiuo Accent 1800

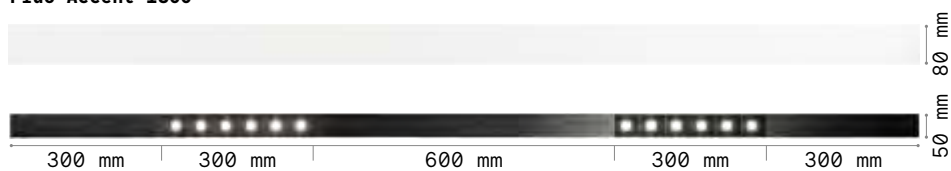

Lo spessore del singolo cappuccio finale è di 2,5 mm.

Fluo Wide



2,890 Kg/0,0183 m³
Lunghezza cavo 2150 mm

LED SMD SAMSUNG Driver TRIDONIC ON/OFF incluso

Potenza	Angolo	Lumen	CCT	Finitura	Codice	€
27 W	105°	3750 lm	3000 K	Alluminio	191447	330
				Bianco	192437	330
				Nero	191997	330
		4050 lm	4000 K	Alluminio	192468	330
				Bianco	192482	330
				Nero	192505	330

DIMMABLE DRIVER* Optional

	Potenza	Output	Misura (LxHxP)	Codice	€
1-10V	28 W	500 mA	280x21x30 mm	216423	128
DALI/Push	27 W	500 mA	280x21x30 mm	216287	145



4,420 Kg/0,0269 m³
Lunghezza cavo 2150 mm

LED SMD SAMSUNG Driver TRIDONIC ON/OFF incluso

Potenza	Angolo	Lumen	CCT	Finitura	Codice	€
36 W	105°	5050 lm	3000 K	Alluminio	192536	425
				Bianco	192550	425
				Nero	192567	425
		5300 lm	4000 K	Alluminio	192598	425
				Bianco	192604	425
				Nero	192628	425

DIMMABLE DRIVER* Optional

	Potenza	Output	Misura (LxHxP)	Codice	€
1-10V	39 W	700 mA	280x21x30 mm	216416	128
DALI/Push	38 W	700 mA	280x21x30 mm	216270	145

MOUNTING KIT Necessario - Pagina 583



Light beam: WIDE

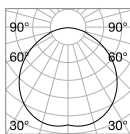

m	lx	Øm
1	1042	2,50
2	260	5,00
3	115	7,50
4	65	10,00
5	41	12,50

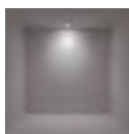

CRI≥83 27W 105° 3650lm 4000K

* Gli alimentatori dimmerabili devono essere ordinati contestualmente al prodotto e verranno già inclusi all'interno degli apparecchi in sostituzione degli alimentatori on-off. La connessione in linea è disponibile soltanto per le versioni on-off dei prodotti.



Fluo Wide 1200

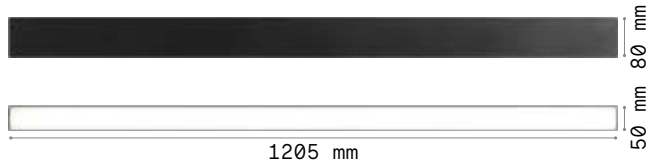

Fluo Wide 1800

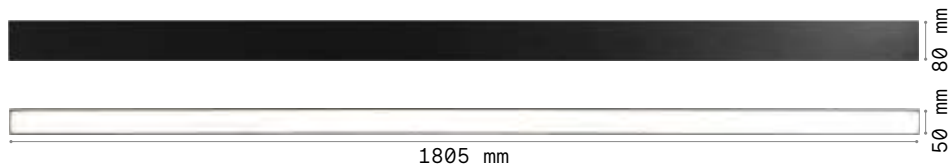

Lo spessore del singolo cappuccio finale è di 2,5 mm.

Fluo Bi-Emission*



LED SMD SAMSUNG

Up-light inclusa - Driver TRIDONIC ON/OFF incluso



2,890 Kg/0,0183 m³
Lunghezza cavo 1800 mm

Potenza	Angolo	Lumen	CCT	Finitura	Codice	€
27 W	105°	3250 lm	3000 K	Alluminio	192659	425
				Bianco	192666	425
				Nero	192710	425
4050 lm	4000 K	4000 K	Alluminio	192734	425	
			Bianco	192741	425	
			Nero	192758	425	

UP-LIGHT INFO

Potenza	Angolo	Lumen	CCT
13 W	105°	1750 lm	3000 K
		2050 lm	4000 K

KIT DIMMABLE DRIVER*

Codice	€	
1-10V	270692	230
DALI/Push	270876	260

LED SMD SAMSUNG

Up-light inclusa - Driver TRIDONIC ON/OFF incluso



4,420 Kg/0,0269 m³
Lunghezza cavo 1800 mm

Potenza	Angolo	Lumen	CCT	Finitura	Codice	€
36 W	105°	5050 lm	3000 K	Alluminio	192727	580
				Bianco	192703	580
				Nero	192697	580
5350 lm	4000 K	4000 K	Alluminio	192680	580	
			Bianco	192673	580	
			Nero	192642	580	

UP-LIGHT INFO

Potenza	Angolo	Lumen	CCT
18 W	105°	2550 lm	3000 K
		2800 lm	4000 K

KIT DIMMABLE DRIVER*

Codice	€	
1-10V	270883	230
DALI/Push	270937	260



Light beam: **BI-EMISSION**
WIDE

MOUNTING KIT Necessario - Pagina 583

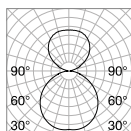

m	lx	Øm
1	512	2,10
2	128	4,21
3	56	6,32
4	32	8,43
5	20	10,54



* Accensione separata dell'emissione diretta e indiretta (disponibile solo per versioni on-off). Regolazione in sincronia dell'emissione diretta e indiretta (versioni con dimmerazione 1-10V e Push). Gli alimentatori dimmerabili devono essere ordinati contestualmente al prodotto e verranno già inclusi all'interno degli apparecchi in sostituzione degli alimentatori on-off. La connessione in linea è disponibile soltanto per le versioni on-off dei prodotti.

CRI≥83 27+13W 105°+105° 3650+2350lm 3000K



Fluo Bi-Emission 1200

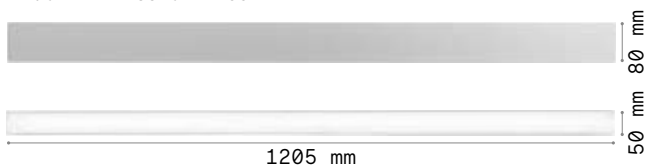

Fluo Bi-Emission 1800

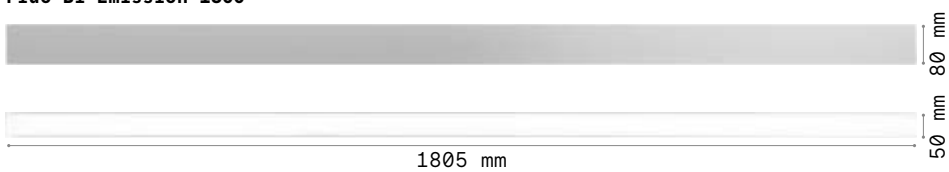

Lo spessore del singolo cappuccio finale è di 2,5 mm.

Fluo - Assembly plans

FLUO SUSPENSION

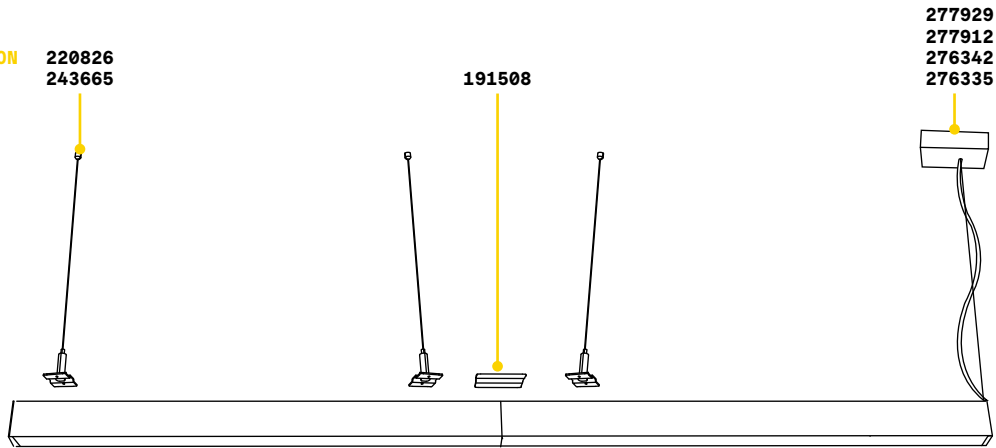

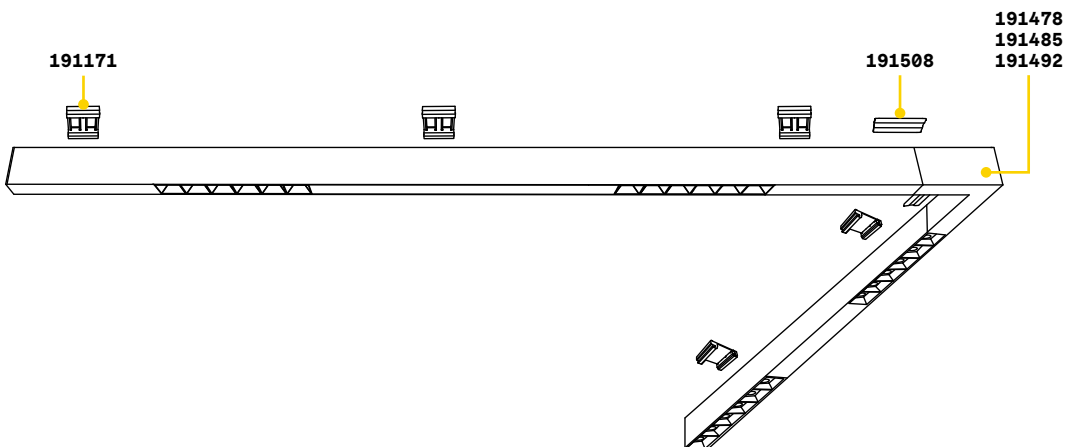

FLUO SURFACE

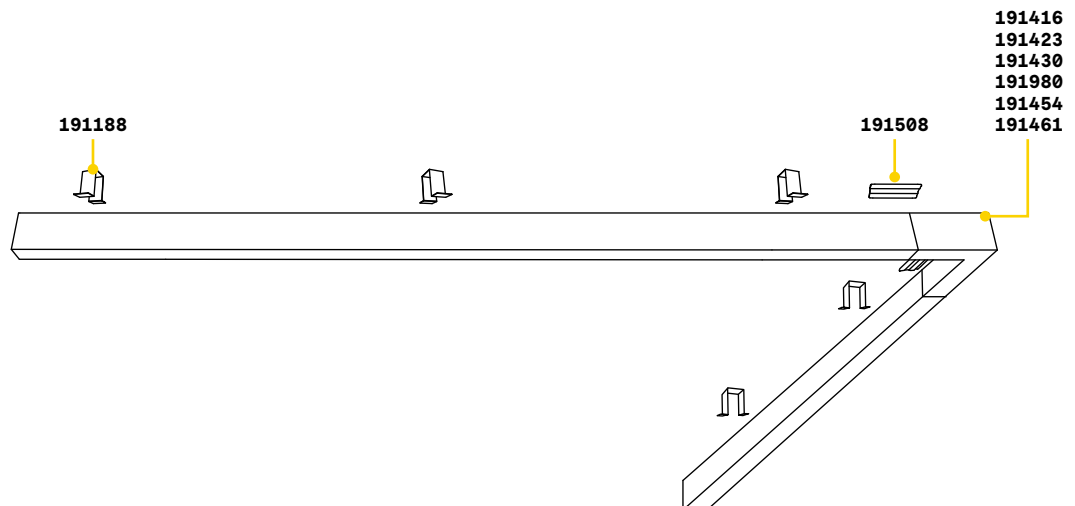

FLUO RECESSED

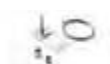

Fluo - Mounting kit

	Necessario	N° Cavi	Lunghezza cavi	Finitura	Codice	€
 KIT SUSPENSION	SI - 1 kit x punto di alimentazione	1	2000 mm	Bianco	277929	31
				Nero	277912	31
		1	5000 mm	Bianco	276342	43
				Nero	276335	43
 KIT SINGLE CABLE	SI - 1 Kit x 600 mm	1	2000 mm		220826	13
		1	5000 mm		243665	19
 KIT RECESSED	SI - 1 Kit x 600 mm				191188	37
	KIT SURFACE	SI - 1 Kit x 600 mm			191171	25

Fluo - Optional

CORNER Optional - Driver ON/OFF incluso - Compatibile con versione Wide

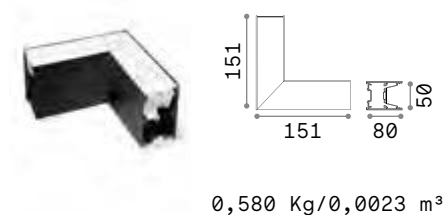

Potenza	Angolo	Lumen	CCT	Finitura	Codice	€
8 W	105°	950 lm	3000 K	Alluminio	191416	95
				Bianco	191423	95
				Nero	191430	95
		1000 lm	4000 K	Alluminio	191980	95
				Bianco	191454	95
				Nero	191461	95

BLINDED CORNER Optional - Compatibile con versione Accent

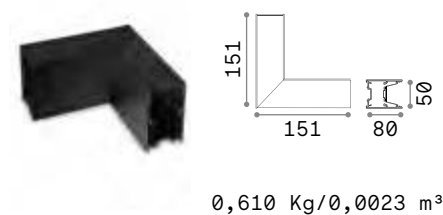

Finitura	Codice	€
Alluminio	191478	65
Bianco	191485	65
Nero	191492	65

STRUCTURE CONNECTOR Lunghezza max per punto di alimentazione: 30 metri



Necessario	Codice	€
SI - 1 Kit x giunzione	191508	12

Steel

Lampada lineare in alluminio con illuminazione diretta e indiretta con controllo dell'abbagliamento. La componente di luce indiretta può essere accesa o spenta mediante interruttore a bordo dell'apparecchio. La lampada è disponibile nel modello WIDE con ottica downlight diffondente in PMMA microprismatizzato (UGR < 19) e nel modello ACCENT con riflettore nero (UGR < 16). Sorgenti LED integrati; disponibile in CCT 3000 K e 4000 K; CRI ≥ 90; lifetime 50.000 h L70B50; IP20. Adatta per uffici, spazi commerciali e retail.

PRO Prodotto ad alto contenuto tecnologico, elevata qualità dei materiali, destinato ad uso professionale.

UGR Articolo con UGR <16 (Accent), <19 (Wide).

Sorgente	LED SMD
Driver incluso	On/Off
Driver disponibili	No
MacAdam	SDCM 3
Ottica	Accent/Wide
CCT	3000 K / 4000 K
CRI	≥90
UGR	<16 (Accent) / <19 (Wide)
Durata LED	50.000 h
Classe isolamento	I
IP	20
Materiale	Alluminio
Garanzia	5 anni





Steel

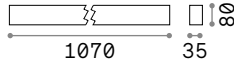
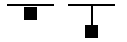

1,990 Kg/0,0178 m³
Lunghezza cavo 1800 mm

LED SMD SAMSUNG

Up-light inclusa - Driver OSRAM ON/OFF incluso - UGR <19

Potenza	Angolo	Lumen	CCT	Finitura	Codice	€
36 W	70°	3350 lm	3000 K	Bianco	267128	290
				Nero	270197	290
		3550 lm	4000 K	Bianco	270203	290
				Nero	267135	290

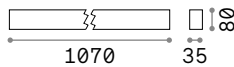

1,980 Kg/0,0178 m³
Lunghezza cavo 1800 mm



LED SMD SAMSUNG

Up-light inclusa - Driver OSRAM ON/OFF incluso - UGR <16

Potenza	Angolo	Lumen	CCT	Finitura	Codice	€
36 W	60°	3000 lm	3000 K	Bianco	270180	345
				Nero	267142	345
		3200 lm	4000 K	Bianco	267159	345
				Nero	270173	345

UP-LIGHT INFO

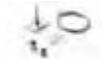
Angolo	Lumen	CCT
110°	1100 lm	3000 K
	1150 lm	4000 K

	Necessario	N° Cavi	Lunghezza cavi	Finitura	Codice	€
	SI - 1 kit x punto di alimentazione	1	2000 mm	Bianco	276311	28
				Nero	276304	28
	SI - 1 Kit x 500 mm	1	2000 mm		271750	13
	SI - 1 Kit x 1000 mm				270210	31
	SI - 1 Kit x giunzione				271712	7



Light beam: **BI-EMISSION ACCENT**

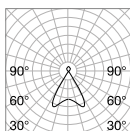

m	lx	Øm
1	2216	1,20
2	554	2,40
3	246	3,60
4	139	4,80
5	89	6,10

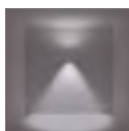

CRI≥90 36W 70° 27701m 4000K



Light beam: **BI-EMISSION WIDE**

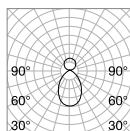

m	lx	Øm
1	1173	1,50
2	293	3,10
3	130	4,60
4	73	6,20
5	47	7,70



CRI≥90 36W 60° 26801m 4000K



Steel Accent



Steel Wide



Office



Lampada lineare in alluminio con illuminazione diretta per applicazione a sospensione. Disponibile in finitura bianca o nera con riflettori di colore nero. Sorgenti LED integrate con controllo dell'abbagliamento (UGR < 16); disponibile in temperatura di colore 3000 K e 4000 K; CRI ≥ 80; 30.000 h di durata L70B50; protezione IP20, classe isolamento I.

Sorgente	LED SMD	Durata LED	50.000 h
Potenza	30W	Classe	I
Driver incluso	On/Off	isolamento	
Driver disponibili	No	IP	20
CCT	3000 K / 4000 K	Materiale	Alluminio
CRI	≥80	Garanzia	5 anni
UGR	<16		

UGR Articolo con UGR <16.

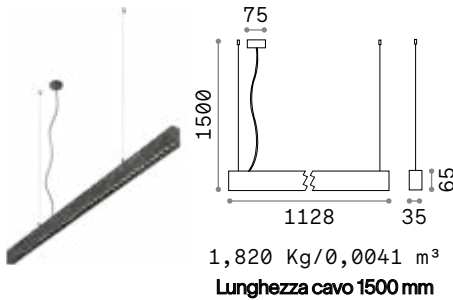

LED SMD Driver ON/OFF incluso

Potenza	Angolo	Lumen	CCT	Finitura	Codice	€
30 W	37°	2800 lm	3000 K	Bianco	271194	188
				Nero	271187	188
30 W	37°	3100 lm	4000 K	Bianco	271217	188
				Nero	271200	188



Light beam: ACCENT

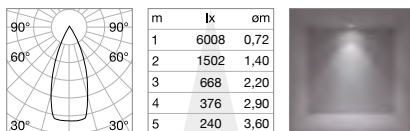

CRI≥80 30W 37° 3100lm 4000K



271194

271187

Nastro flessibile in acciaio per applicazione da parete a parete, utilizzato come supporto per applicazione di strip led, diventa una sorgente luminosa per illuminazione indiretta. Ha una lunghezza massima di 5 o 10 metri e con la sua sezione minimale scompare all'interno dell'ambiente per garantire un risultato di estrema pulizia formale. Disponibile nelle finiture acciaio, bianco oppure nero. Ideale per ambienti dal carattere storico e architettonico già fortemente personalizzati.

STRIP LED SUPPORT

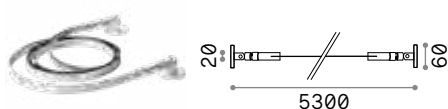

Lunghezza	Peso	Volume	Finitura	Codice	€
5000 mm	0,35 Kg	0,0234 m ³	Acciaio	258300	130
			Bianco	302256	130 <small>new</small>
			Nero	302263	130 <small>new</small>

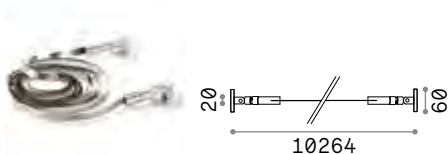

Lunghezza	Peso	Volume	Finitura	Codice	€
10000 mm	0,45 Kg	0,0029 m ³	Acciaio	302270	165 <small>new</small>
			Bianco	302287	165 <small>new</small>
			Nero	302294	165 <small>new</small>

STRIP LED AND DRIVER Necessario - Pagina 814

RECOMMENDED STRIP LED AND DRIVER

STRIP LED SMD 2835 120 LED/m CRI ≥ 90

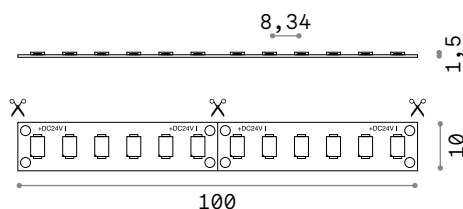

Potenza	IP	Lumen	CCT	Lunghezza	Codice	€
15 W/m	IP20	1370 lm/m	2700 K	5000 mm	272498	50
		1400 lm/m	3000 K	5000 mm	272481	50
		1450 lm/m	4000 K	5000 mm	272474	50
	IP65	1400 lm/m	3000 K	5000 mm	272504	65
		1450 lm/m	4000 K	5000 mm	287959	65

DRIVER ON/OFF



Light beam: **INDIRECT**



Driver	Potenza	Output	Classe	Misura (LxHxP)	Codice	€
On-Off	30 W	24 Vdc	□	140x28x45 mm	124070	17,50
	60 W	24 Vdc	□	186x33x50 mm	124087	30
	150 W	24 Vdc	⊕	268x31x45 mm	124117	50



Vision

Profilo in alluminio estruso con superficie anodizzata e verniciata a polveri, disponibile nelle finiture bianco e nero, diffusore in PMMA satinato. Sono disponibili barre in diverse lunghezze nella versione TRIM per installazione a incasso in pannelli o soffitti in cartongesso e nella versione TRIMLESS per installazione a parete e soffitto, disponibile kit per installazione a sospensione. I profili lineari sono disponibili nelle lunghezze di 2000 e 3000 mm, sono componibili a seconda del disegno desiderato e sono sezionabili a misura. Strip LED e driver devono essere abbinati per completare l'installazione: sorgenti luminose di potenza disponibili con temperatura di colore di 3000 K e 4000 K, CRI ≥ 90 e indice protezione IP20. Sistema dotato di ampia flessibilità, adatto per l'illuminazione generale degli ambienti COMMERCIALI e nelle aree vendita nel settore RETAIL.

Versione	Trim / Trimless
Lunghezza	2000 / 3000 mm
Materiale	Alluminio





Vision Trimless

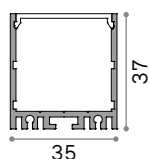

PROFILE Kit per montaggio incluso

Lunghezza	Peso	Volume	Finitura	Codice	€
2000 mm	1,40 Kg	0,0032 m ³	Bianco	270524	65
	1,40 Kg	0,0032 m ³	Nero	270517	65
3000 mm	2,10 Kg	0,0048 m ³	Bianco	270548	95
	2,10 Kg	0,0048 m ³	Nero	270531	95



SUSPENSION KIT

Necessario	N° Cavi	Lunghezza cavi	Codice	€
No - 1 Kit x 2000 mm	2	3000 mm	270449	16
No - 1 Kit x 2000 mm	2	5000 mm	270456	20



STRUCTURE CONNECTOR

SI - 1 Kit x giunzione			270463	5
------------------------	--	--	--------	---

STRIP LED AND DRIVER Necessario - Pagina 814

Strip LED consigliata max 39 W/m

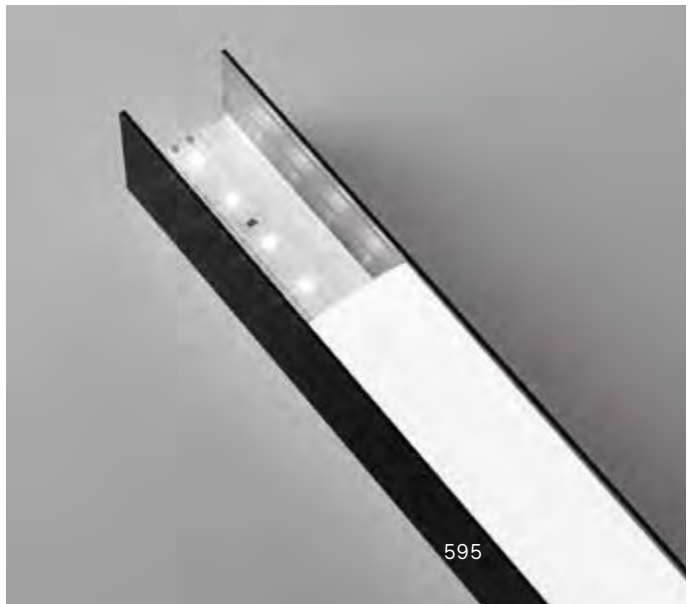

Vision Trim

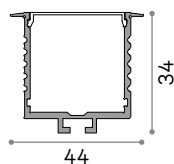

PROFILE Kit per montaggio incluso

Lunghezza	Peso	Volume	Finitura	Codice	€
2000 mm	1,26 Kg	0,0050 m ³	Bianco	270487	70
	1,26 Kg	0,0050 m ³	Nero	270470	70
3000 mm	1,89 Kg	0,0075 m ³	Bianco	270500	105
	1,89 Kg	0,0075 m ³	Nero	270494	105



STRUCTURE CONNECTOR

Necessario	Codice	€
SI - 1 Kit x giunzione	271125	5

STRIP LED AND DRIVER Necessario - Pagina 814

Strip LED consigliata max 39 W/m

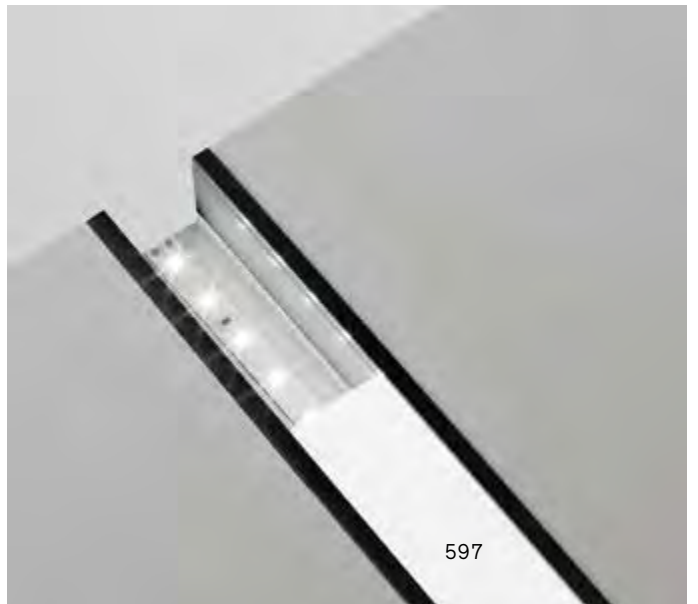

Slot ^{new}

Profilo in alluminio estruso con superficie anodizzata o verniciata a polveri, disponibile nelle finiture bianco, nero e alluminio, diffusore in PMMA satinato. Sono disponibili barre in diverse sezioni e lunghezze nella versione RECESSED per installazione a incasso in soffitti in cartongesso e nella versione SURFACE per installazione a parete o soffitto. I modelli ANGULAR in versione tonda e quadrata sono concepiti con un angolo interno di inclinazione della sorgente luminosa per l'illuminazione ottimale all'interno di velette e gole luminose. I profili lineari sono disponibili nelle lunghezze di 1000, 2000 e 3000 mm, sono componibili a seconda del disegno desiderato e sono sezionabili a misura. Strip LED e driver devono essere abbinati per completare l'installazione: sorgenti luminose disponibile con temperatura di colore di 2700 K, 3000 K, 4000 K, CRI ≥ 80 , ≥ 85 e ≥ 90 , indice protezione IP20 e IP65.

Versione	Recessed / Surface / Angular
Larghezza	12 / 14 / 15 / 16 / 20 / 31 mm
Materiale	Alluminio





Slot Recessed

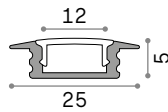

PROFILE 12 mm Kit per montaggio incluso

Lunghezza	Peso	Volume	Finitura	Codice	€
1000 mm	0,15 Kg	0,0010 m ³	Bianco	124155	16
2000 mm	0,35 Kg	0,0020 m ³	Bianco	203102	27
3000 mm	0,54 Kg	0,0029 m ³	Bianco	204611	40

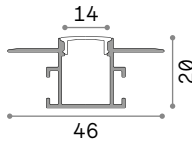

PROFILE 14 mm

Lunghezza	Peso	Volume	Finitura	Codice	€
2000 mm	0,65 Kg	0,0020 m ³	Bianco	223704	62
3000 mm	0,90 Kg	0,0029 m ³	Bianco	223711	98

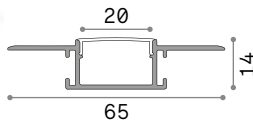

PROFILE 20 mm

Lunghezza	Peso	Volume	Finitura	Codice	€
2000 mm	0,60 Kg	0,0020 m ³	Bianco	223728	73
3000 mm	0,90 Kg	0,0029 m ³	Bianco	223735	107

KIT PROFILE 14 / 20 mm



KIT LINEAR

KIT RIGHT-LEFT

KIT VERTICAL-HORIZONTAL

Necessario	Codice	€
SI - 1Kit x giunzione	223766	6
SI - 1Kit x giunzione	223759	6
SI - 1Kit x giunzione	223742	6

STRIP LED AND DRIVER Necessario - Pagina 858

Strip LED consigliata max 14,4 W/m

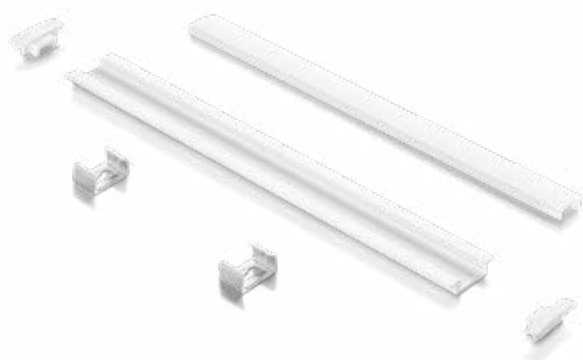

Kit per montaggio PROFILE 12 mm.



223728
223735

Slot Surface

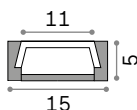
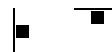

PROFILE 15 mm Kit per montaggio incluso

Lunghezza	Peso	Volume	Finitura	Codice	€
1000 mm	0,15 Kg	0,0010 m ³	Bianco	124131	13
	0,15 Kg	0,0010 m ³	Alluminio	124124	13
2000 mm	0,20 Kg	0,0020 m ³	Bianco	203089	22
	0,20 Kg	0,0020 m ³	Alluminio	203072	22
3000 mm	0,34 Kg	0,0029 m ³	Bianco	204598	32
	0,34 Kg	0,0029 m ³	Alluminio	204581	32

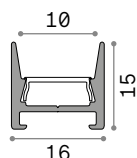

PROFILE 16 mm Kit per montaggio incluso

Lunghezza	Peso	Volume	Finitura	Codice	€
2000 mm	0,20 Kg	0,0015 m ³	Bianco	307145	25 <i>new</i>
			Nero	296463	25 <i>new</i>

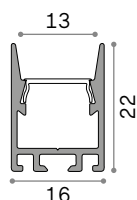

PROFILE 16 mm Kit per montaggio incluso

Lunghezza	Peso	Volume	Finitura	Codice	€
2000 mm	0,40 Kg	0,0021 m ³	Bianco	307152	29 <i>new</i>
			Nero	296456	29 <i>new</i>



COVER 16 mm

Necessario	Finitura	Codice	€
No	Nero	307251	6 <i>new</i>

STRIP LED AND DRIVER Necessario - Pagina 858

Strip LED consigliata max 14,4 W/m



Kit per montaggio PROFILE 15 mm.



Slot Angular

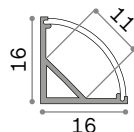
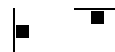

ROUND 16x16

Lunghezza	Peso	Volume	Finitura	Codice	€
1000 mm	0,15 Kg	0,0010 m ³	Bianco	126548	12
	0,15 Kg	0,0010 m ³	Alluminio	126531	12
2000 mm	0,30 Kg	0,0020 m ³	Bianco	203126	28
	0,30 Kg	0,0020 m ³	Alluminio	203119	28
3000 mm	0,44 Kg	0,0030 m ³	Bianco	204635	40
	0,44 Kg	0,0030 m ³	Alluminio	204628	40

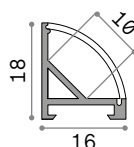

ROUND 16x18

Lunghezza	Peso	Volume	Finitura	Codice	€
2000 mm	0,30 Kg	0,0020 m ³	Bianco	267401	24
	0,30 Kg	0,0020 m ³	Alluminio	267395	24
3000 mm	0,45 Kg	0,0029 m ³	Bianco	267425	38
	0,45 Kg	0,0029 m ³	Alluminio	267418	38

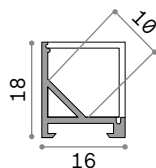

SQUARE 16x18

Lunghezza	Peso	Volume	Finitura	Codice	€
2000 mm	0,30 Kg	0,0020 m ³	Bianco	267449	26
	0,30 Kg	0,0020 m ³	Alluminio	267432	26
3000 mm	0,45 Kg	0,0029 m ³	Bianco	267463	38
	0,45 Kg	0,0029 m ³	Alluminio	267456	38

STRIP LED AND DRIVER Necessario - Pagina 814

Strip LED consigliata max 14,4 W/m

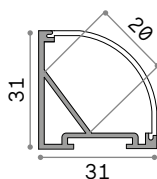

ROUND 31x31

Lunghezza	Peso	Volume	Finitura	Codice	€
2000 mm	0,70 Kg	0,0020 m ³	Bianco	267722	32
	0,70 Kg	0,0020 m ³	Alluminio	267715	32
3000 mm	1,05 Kg	0,0029 m ³	Bianco	267746	44
	1,05 Kg	0,0029 m ³	Alluminio	267739	44

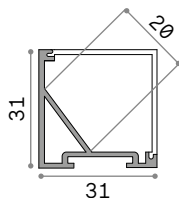

SQUARE 31x31

Lunghezza	Peso	Volume	Finitura	Codice	€
2000 mm	0,70 Kg	0,0020 m ³	Bianco	267487	35
	0,70 Kg	0,0020 m ³	Alluminio	267470	35
3000 mm	1,05 Kg	0,0029 m ³	Bianco	267500	50
	1,05 Kg	0,0029 m ³	Alluminio	267494	50

STRIP LED AND DRIVER Necessario - Pagina 858

Strip LED consigliata max 14,4 W/m



Kit per montaggio PROFILE 16x16 mm.



















Interni

Proiettori e binari

Indice alfabetico

Byte	639
Display	642
Eos	632
Fox	624
Glim	640
Konig	640
Link	650
Look	641
Mouse	638
Pov	636
Quick	608
Smile	616
Spot	638

Indice icone

		
Quick 608	Smile 616	Fox 624
		
Eos 632	Pov 636	Mouse 638
		
Spot 638	Byte 639	Glim 640
		
Konig 640	Look 641	
		
Display Accent 644	Display Wide 646	Display UGR 648
		
Link 650		

Quick

Proiettore cilindrico in alluminio estruso adatto per installazione su binario trifase. Verniciatura a polveri bianco o nero, testata girevole 355° e orientabile 90°. Il driver di alimentazione incluso, trova alloggiamento nel corpo cilindrico del proiettore stesso. Disponibile anche in versione dimmerabile 1-10 V o DALI. Sorgente luminosa con tecnologia COB LED integrato per la massima efficienza, disponibile con temperatura di colore di 3000 K o 4000 K; LED efficienza energetica elevata resa cromatica fino a CRI ≥90; binning iniziale ≤3-Step MacAdam; ottica a fascio simmetrico con tre diversi angoli di emissione e controllo dell'abbagliamento (UGR <19). Montaggio e smontaggio senza utensili. Protezione IP20; classe isolamento I; durata utile LED 50.000 h L80B50. Ideale per l'illuminazione di grandi ambienti dove viene richiesta ampia flessibilità e resa cromatica, ad esempio spazi MUSEALI, COMMERCIALI e RETAIL.

PRO

Prodotto ad alto contenuto tecnologico, elevata qualità dei materiali, destinato ad uso professionale.

Sorgente	LED COB
Potenza	15W / 21W / 28W
Driver incluso	On/Off / 1-10V / DALI
Driver disponibili	No
Binario	Trifase (standard Eutrac)
MacAdam	SDCM 3
CCT	3000 K / 4000 K
CRI	≥80 / ≥90
Durata LED	50.000h
Classe isolamento	I
IP	20
Materiale	Alluminio
Garanzia	5 anni

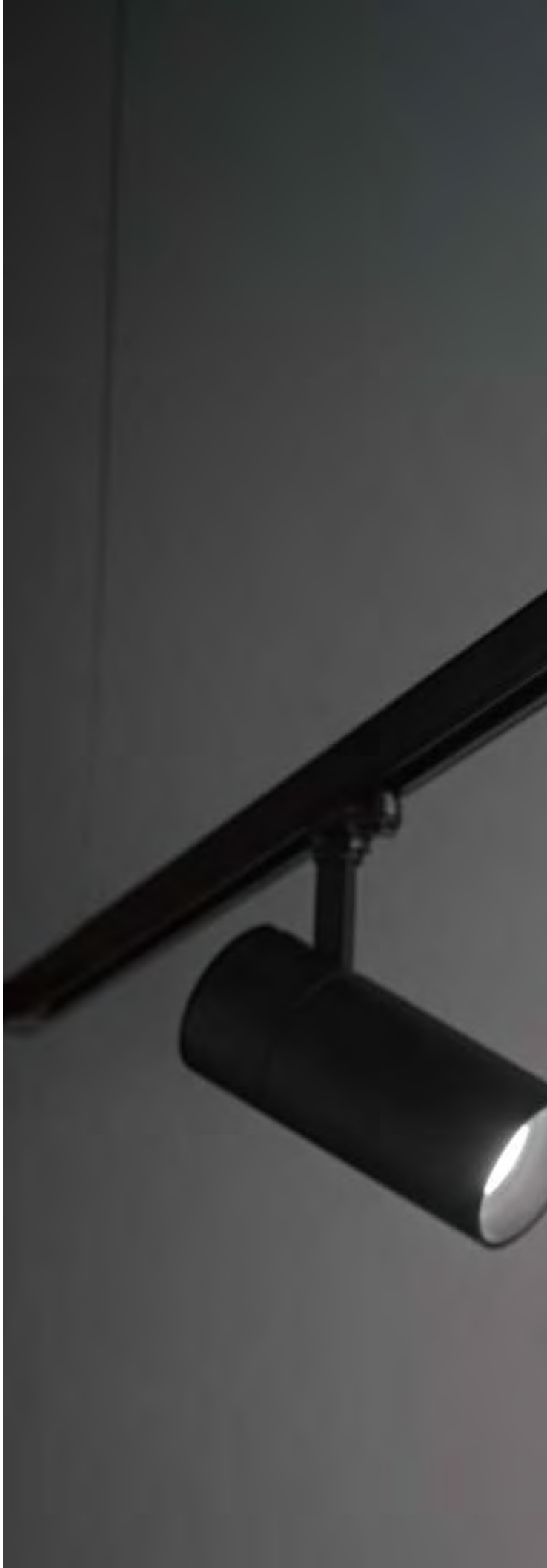

[Link - Pagina 650](#)



Quick 15W

LED COB CITIZEN

CRI ≥ 80

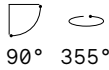
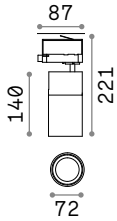

0,760 Kg/0,0038 m³

Potenza	Angolo	Driver	Lumen	CCT	Finitura	Codice	€
15W	30°	On-Off	1800 lm	3000 K	Bianco	222509	145
					Nero	222523	145
		1-10V	1800 lm	3000 K	Bianco	222530	145
					Nero	222547	145
		DALI	1800 lm	3000 K	Bianco	249643	195
					Nero	247861	195
					Bianco	249681	220
					Nero	246437	220

CRI ≥ 90

Potenza	Angolo	Driver	Lumen	CCT	Finitura	Codice	€
15W	30°	On-Off	1550 lm	3000 K	Bianco	222554	145
					Nero	222561	145
			1700 lm	4000 K	Bianco	222578	145
					Nero	222585	145



FILTER HONEYCOMB



LENS*



SINGLE CONNECTION

Necessario	Angolo	Driver	Finitura	Codice	€
No			Nero	222608	9
No	15°		Trasparen.	222592	9
No	45°		Trasparen.	253558	9
No		On/Off	Bianco	170145	27
			Nero	170152	27
		DALI/1-10V	Bianco	247649	29
			Nero	247632	29



Light beam: ACCENT

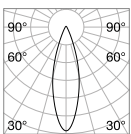

m	lx	Øm
1	3451	0,51
2	862	1,02
3	383	1,53
4	215	2,04
5	138	2,55

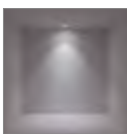

CRI ≥ 80 15W 30° 1900lm 3000K

* La lente deve essere ordinata contestualmente al prodotto e verrà montata nel prodotto al posto della lente standard inclusa.

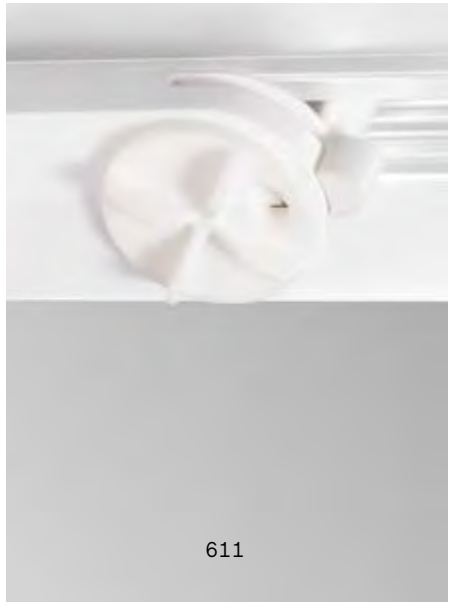

Quick 21W

LED COB CITIZEN

CRI ≥ 80

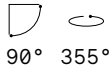
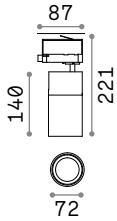

0,760 Kg/0,0038 m³

Potenza	Angolo	Driver	Lumen	CCT	Finitura	Codice	€	
21W	30°	On-Off	2450 lm	3000 K	Bianco	247946	155	
					Nero	247939	155	
		1-10V	2700 lm	4000 K	Bianco	247960	155	
					Nero	247953	155	
			DALI	2450 lm	3000 K	Bianco	249650	230
						Nero	247878	230
DALI	2450 lm	3000 K	Bianco	249698	260			
			Nero	246444	260			

CRI ≥ 90

Potenza	Angolo	Driver	Lumen	CCT	Finitura	Codice	€
21W	30°	On-Off	2150 lm	3000 K	Bianco	247977	155
					Nero	225364	155
			2350 lm	4000 K	Bianco	247991	155
					Nero	247984	155



FILTER HONEYCOMB



LENS*



SINGLE CONNECTION

Necessario	Angolo	Driver	Finitura	Codice	€
No			Nero	222608	9
No	15°		Trasparen.	222592	9
No	45°		Trasparen.	253558	9
No		On/Off	Bianco	170145	27
			Nero	170152	27
		DALI/1-10V	Bianco	247649	29
			Nero	247632	29



Light beam: ACCENT

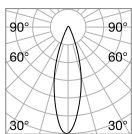

m	lx	Øm
1	6576	0,57
2	1644	1,14
3	731	1,71
4	411	2,28
5	263	2,85

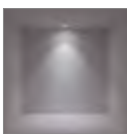

CRI ≥ 80 21W 30° 26501m 3000K

* La lente deve essere ordinata contestualmente al prodotto e verrà montata nel prodotto al posto della lente standard inclusa.

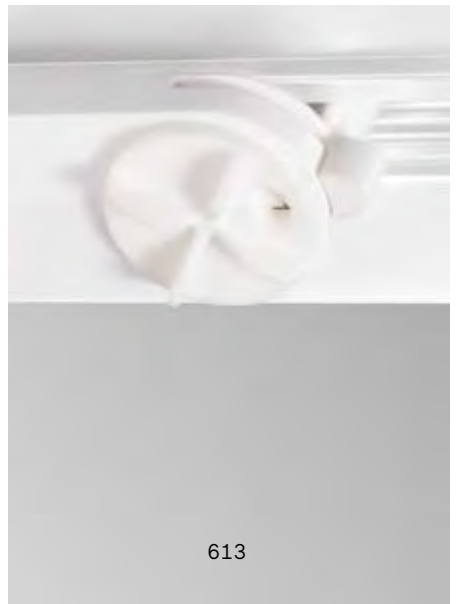

Quick 28W

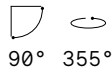
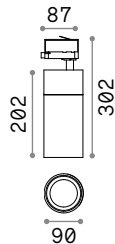

1,200 Kg/0,0063 m³

LED COB CITIZEN

CRI ≥ 80

Potenza	Angolo	Driver	Lumen	CCT	Finitura	Codice	€	
28 W	30°	On-Off	3550 lm	3000 K	Bianco	222615	185	
					Nero	222622	185	
		1-10V	3800 lm	4000 K	Bianco	222639	185	
					Nero	222646	185	
			DALI	3550 lm	3000 K	Bianco	249674	250
						Nero	247885	250
					Bianco	249704	310	
					Nero	246413	310	

CRI ≥ 90

Potenza	Angolo	Driver	Lumen	CCT	Finitura	Codice	€
28 W	30°	On-Off	3100 lm	3000 K	Bianco	222653	185
					Nero	222660	185
			3300 lm	4000 K	Bianco	222677	185
					Nero	222684	185



FILTER HONEYCOMB

LENS*

SINGLE CONNECTION

Necessario	Angolo	Driver	Finitura	Codice	€
No			Nero	222714	10
No	18°		Trasparen.	222691	10
No	45°		Trasparen.	222707	10
No		On/Off	Bianco	170145	27
			Nero	170152	27
		DALI/1-10V	Bianco	247649	29
			Nero	247632	29



Light beam: ACCENT

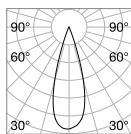

m	lx	Øm
1	8760	0,55
2	2190	1,11
3	973	1,67
4	547	2,22
5	350	2,78



CRI ≥ 80 28 W 30° 3850 lm 3000 K

* La lente deve essere ordinata contestualmente al prodotto e verrà montata nel prodotto al posto della lente standard inclusa.

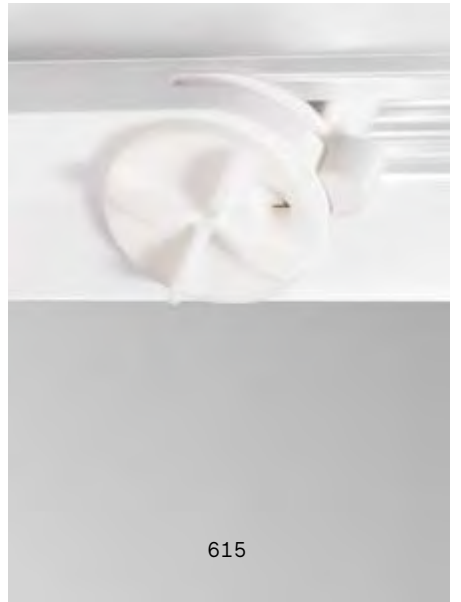

Smile

Proiettore cilindrico in alluminio (estrusione + lavorazione CNC + forgiatura) adatto per installazione su binario trifase.

Verniciatura a polveri in bianco o nero, testata girevole 350° e orient. 90°; il driver di alimentazione è incluso e trova alloggiamento nel corpo cilindrico del proiettore stesso.

Sorgente luminosa con tecnologia COB LED integrato, disponibile con una temperatura di colore di 3000 K o 4000K e con indice di resa cromatica fino a 90; binning iniziale ≤4-Step MacAdam; ottica a fascio simmetrico con tre diversi angoli di emissione e controllo dell'abbagliamento (UGR <19). Montaggio e smontaggio senza utensili. Protezione IP20; classe isolamento II; durata utile LED 50.000h L70B50. Ideale per l'illuminazione di grandi ambienti dove viene richiesta ampia flessibilità e resa cromatica, ad esempio spazi MUSEALI, COMMERCIALI e RETAIL.



Articolo con UGR <19.

Sorgente	LED COB
Potenza	15W / 20W / 30W
Driver incluso	On/Off
Driver disponibili	No
Binario	Trifase (standard Eutrac)
CCT	3000 K / 4000 K
CRI	≥82 / ≥92
Durata LED	50.000h
Classe isolamento	II
IP	20
Materiale	Alluminio
Garanzia	5 anni



[Link - Pagina 650](#)





Smile 15W

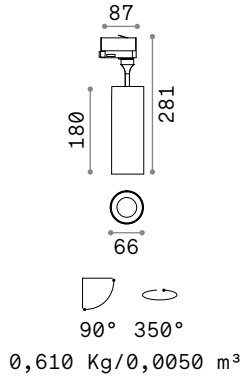

LED COB PHILIPS Driver TRIDONIC ON/OFF incluso

CRI ≥ 82

Potenza	Angolo	Lumen	CCT	Finitura	Codice	€
15W	24°	2050 lm	3000 K	Bianco	189574	120
				Nero	189581	120
		2250 lm	4000 K	Bianco	189611	120
				Nero	189628	120
	36°	2050 lm	3000 K	Bianco	189758	120
				Nero	189765	120
		2250 lm	4000 K	Bianco	189796	120
				Nero	189802	120
	50°	2050 lm	3000 K	Bianco	189932	120
				Nero	189949	120
		2250 lm	4000 K	Bianco	189956	120
				Nero	189963	120

CRI ≥ 92

Potenza	Angolo	Lumen	CCT	Finitura	Codice	€
15W	24°	1700 lm	3000 K	Bianco	189598	120
				Nero	189604	120
	36°	1700 lm	3000 K	Bianco	189772	120
				Nero	189789	120
	50°	1700 lm	3000 K	Bianco	189970	120
				Nero	189987	120



FILTER HONEYCOMB

FILTER ELLIPTICAL

RING

SINGLE CONNECTION

Necessario	Driver	Finitura	Codice	€
No		Nero	189536	6
No		Trasparen.	189543	8
No		Bianco	189505	15
No	On/Off	Bianco	170145	27
		Nero	170152	27



Light beam: SPOT

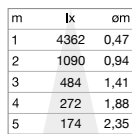
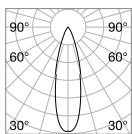

CRI ≥ 82 15W 24° 1600lm 3000K



Light beam: ACCENT

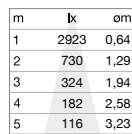
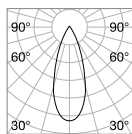

CRI ≥ 82 15W 36° 1600lm 3000K



Light beam: WIDE

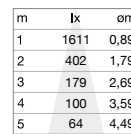
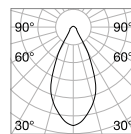

CRI ≥ 82 15W 50° 1600lm 3000K



Smile 20W

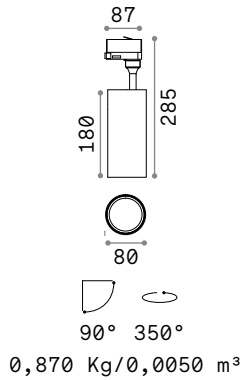

LED COB PHILIPS Driver TRIDONIC ON/OFF incluso

CRI ≥ 82

Potenza	Angolo	Lumen	CCT	Finitura	Codice	€
20W	24°	3000 lm	3000 K	Bianco	189635	135
				Nero	189642	135
		3150 lm	4000 K	Bianco	189673	135
				Nero	189680	135
	36°	3000 lm	3000 K	Bianco	189819	135
				Nero	189826	135
		3150 lm	4000 K	Bianco	189857	135
				Nero	189864	135
	50°	3000 lm	3000 K	Bianco	189994	135
				Nero	190006	135
		3150 lm	4000 K	Bianco	190013	135
				Nero	190020	135

CRI ≥ 92

Potenza	Angolo	Lumen	CCT	Finitura	Codice	€
20W	24°	2550 lm	3000 K	Bianco	189659	135
				Nero	189666	135
	36°	2550 lm	3000 K	Bianco	189833	135
				Nero	189840	135
	50°	2550 lm	3000 K	Bianco	190037	135
				Nero	190044	135



FILTER HONEYCOMB

FILTER ELLIPTICAL

RING

SINGLE CONNECTION

Necessario	Driver	Finitura	Codice	€
No		Nero	190181	6
No		Trasparen.	190259	9
No		Bianco	189529	13
No	On/Off	Bianco	170145	27
		Nero	170152	27



Light beam: SPOT

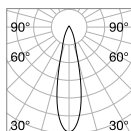

m	lx	cm
1	8787	0,42
2	2196	0,85
3	976	1,28
4	549	1,71
5	351	2,14



CRI ≥ 82 20W 24° 2350lm 3000K



Light beam: ACCENT

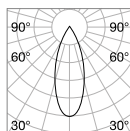

m	lx	cm
1	4526	0,64
2	1131	1,28
3	502	1,92
4	282	2,56
5	181	3,20



CRI ≥ 82 20W 36° 2350lm 3000K



Light beam: WIDE

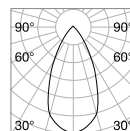

m	lx	cm
1	2657	0,93
2	664	1,87
3	295	2,81
4	166	3,75
5	106	4,69

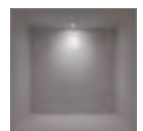

CRI ≥ 82 20W 50° 2350lm 3000K



Smile 30W

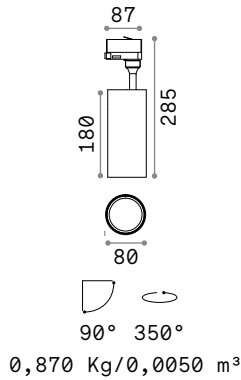

LED COB PHILIPS Driver TRIDONIC ON/OFF incluso

CRI ≥ 82

Potenza	Angolo	Lumen	CCT	Finitura	Codice	€
30W	24°	4000 lm	3000 K	Bianco	189697	150
				Nero	189703	150
		4200 lm	4000 K	Bianco	189734	150
				Nero	189741	150
	36°	4000 lm	3000 K	Bianco	189871	150
				Nero	189888	150
		4200 lm	4000 K	Bianco	189895	150
				Nero	189901	150
	50°	4000 lm	3000 K	Bianco	190051	150
				Nero	190068	150
		4200 lm	4000 K	Bianco	190075	150
				Nero	190082	150

CRI ≥ 92

Potenza	Angolo	Lumen	CCT	Finitura	Codice	€
30W	24°	3500 lm	3000 K	Bianco	189710	150
				Nero	189727	150
	36°	3500 lm	3000 K	Bianco	189918	150
				Nero	189925	150
	50°	3500 lm	3000 K	Bianco	190099	150
				Nero	190105	150



FILTER HONEYCOMB

FILTER ELLIPTICAL

RING

SINGLE CONNECTION

Necessario	Driver	Finitura	Codice	€
No		Nero	190181	6
No		Trasparen.	190259	9
No		Bianco	189529	13
No	On/Off	Bianco	170145	27
		Nero	170152	27



Light beam: SPOT



Light beam: ACCENT



Light beam: WIDE

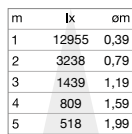
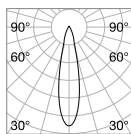

CRI ≥ 82 30W 24° 3150lm 3000K

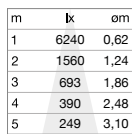
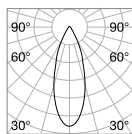

CRI ≥ 82 30W 36° 3150lm 3000K

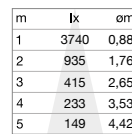
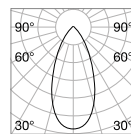

CRI ≥ 82 30W 50° 3150lm 3000K



Fox new

Proiettore cilindrico in alluminio estruso, adatto per installazione su binario trifase. Verniciatura a polveri in bianco, nero oppure ottone satinato, testata girevole 350° e orientabile fino a 90°; il driver di alimentazione è incluso e trova alloggio nel corpo cilindrico del proiettore stesso. Disponibile anche in versione dimmerabile 1-10 V o DALI. Sorgente luminosa con tecnologia COB LED integrato, disponibile in tre diverse potenze con una temperatura di colore di 3000 K o 4000K e con indice di resa cromatica fino a 90; binning iniziale ≤3-Step MacAdam; ottica simmetrica a fascio di apertura medio. Montaggio e smontaggio senza utensili. Protezione IP20; durata utile LED 30.000 h L70B50. Ideale per l'illuminazione di piccoli e medi ambienti dove vengono richiesti ampia flessibilità di disposizione, ad esempio in spazi COMMERCIALI e RETAIL, e un rapporto ottimale tra prestazioni e prezzo.

Sorgente	LED COB
Potenza	8W / 15W / 25W
Driver incluso	On/Off / 1-10V / DALI
Driver disponibili	No
Binario	Trifase (standard Eutrac)
MacAdam	SDCM3
CCT	3000 K / 4000 K
CRI	≥80 / ≥90
Durata LED	30.000 h
Classe isolamento	On-Off I, 1-10V / DALI II
IP	20
Materiale	Alluminio
Garanzia	5 anni



[Link - Pagina 650](#)



Hot Drinks		Cold Drinks	
Espresso	1.30 - 2.00	Mineral Water	0.33 l 2.00
Espresso macchiato	1.00 - 2.30	Afri Cola	0.2 l 2.00
Americano	1.00	Svez Single Lemon	0.33 l 2.40
Cappuccino	2.10	... cherry, pear, caramel	
Caffè latte	2.20	Homemade Tamarind-Lemonade	0.33 l 3.00
Flat White	2.00	Juice	0.2 l 2.00
Chai Latte	2.00	... apple, raspberry	
Hot Chocolate	2.20	Juice w. sparkling water	0.33 l 2.80
Hot milk w. Honey	2.00	Orange juice	0.33 l 2.00
Extra egg		Lemonade	0.33 l 2.40
soy-milk		Club Mate	0.33 l 2.20
whipped cream		Homemade Gingerbeer (no alcohol)	0.35 l 3.00
Acai-Mango-Zinger, Honey-Vanilla-Chamomile, Sleepy-Time, Tension-Tamer, Authentic Green, Black-Cherry-Berry, Apple Cinnamon, Chai Bengal Spice			
Fresh Tea	2.50		
Ginger, Mint or Lem.			



Fox 8W

LED COB BRIDGELUX Driver incluso

CRI ≥ 80

Potenza	Angolo	Lumen	CCT	Driver	Finitura	Codice	€
8W	41°	1000 lm	3000 K	On-Off	Bianco	250410	49
					Nero	250403	49
		1050 lm	4000 K		Ottone	283920	49 <i>new</i>
					Bianco	271453	49
					Nero	271446	49

CRI ≥ 90

Potenza	Angolo	Lumen	CCT	Driver	Finitura	Codice	€
8W	41°	800 lm	3000 K	On-Off	Bianco	285368	49
					Nero	285351	49
				1-10V	Bianco	302546	85 <i>new</i>
					Nero	302539	85 <i>new</i>

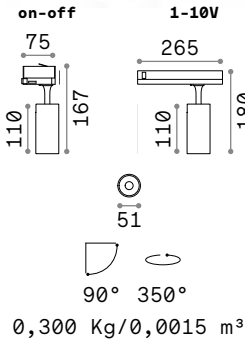

Necessario	Angolo	Driver	Finitura	Codice	€
No	15°		Trasparen.	302744	5 <i>new</i>
No		On/Off	Bianco	170145	27
			Nero	170152	27



LENS*

SINGLE CONNECTION



Light beam: ACCENT

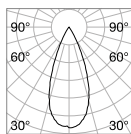

m	lx	Øm
1	2067	0,77
2	517	1,54
3	230	2,30
4	129	3,07
5	83	3,84



CRI ≥ 80 8W 41° 950lm 3000K

* La lente deve essere ordinata contestualmente al prodotto e verrà montata nel prodotto al posto della lente standard inclusa.

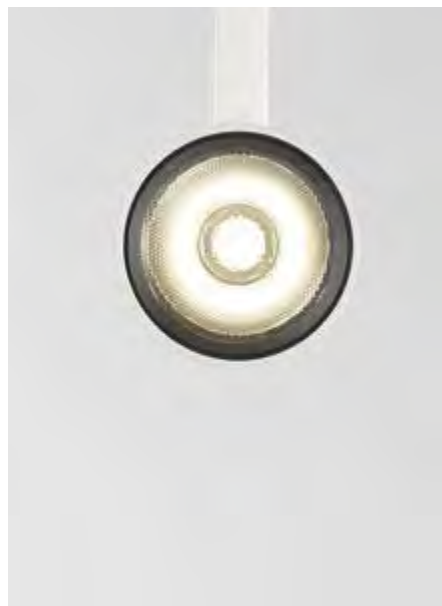

Fox 15W

LED COB BRIDGELUX Driver incluso

CRI ≥ 80

Potenza	Angolo	Lumen	CCT	Driver	Finitura	Codice	€
15W	41°	1700 lm	3000 K	On-Off	Bianco	250434	55
					Nero	250427	55
					Ottone	283937	55 <i>new</i>
		1750 lm		Bianco	267784	55	
				Nero	267777	55	

CRI ≥ 90

Potenza	Angolo	Lumen	CCT	Driver	Finitura	Codice	€
15W	41°	1400 lm	3000 K	On-Off	Bianco	285382	55
					Nero	285375	55
					1-10V	Bianco	302560
				DALI	Nero	302553	90 <i>new</i>
					Bianco	302584	110 <i>new</i>
					Nero	302577	110 <i>new</i>

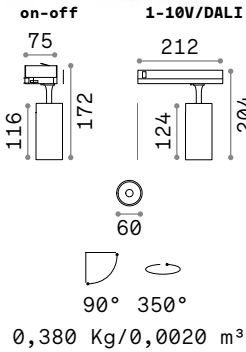

Necessario	Angolo	Driver	Finitura	Codice	€
No	15°		Trasparen.	302751	5 <i>new</i>
No		On/Off	Bianco	170145	27
			Nero	170152	27



LENS*

SINGLE CONNECTION



Light beam: ACCENT

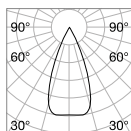

CRI ≥ 80 15W 41° 1500lm 3000K

* La lente deve essere ordinata contestualmente al prodotto e verrà montata nel prodotto al posto della lente standard inclusa.



Fox 25W



LED COB BRIDGELUX Driver incluso

CRI ≥ 80

Potenza	Angolo	Lumen	CCT	Driver	Finitura	Codice	€
25 W	35°	2950 lm	3000 K	On-Off	Bianco	250458	60
					Nero	250441	60
		3050 lm	4000 K		Ottone	283944	60 <i>new</i>
		Bianco	267807		60		
		Nero	267791		60		

CRI ≥ 90

Potenza	Angolo	Lumen	CCT	Driver	Finitura	Codice	€
25 W	35°	2450 lm	3000 K	On-Off	Bianco	285405	60
					Nero	285399	60
					1-10V	Bianco	302607
				Nero	302591	100 <i>new</i>	
				DALI	Bianco	302621	115 <i>new</i>
				Nero	302614	115 <i>new</i>	

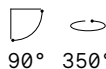
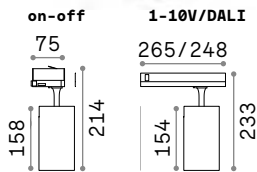

0,540 Kg/0,0027 m³

Necessario	Angolo	Driver	Finitura	Codice	€
No	15°		Trasparen.	302768	5 <i>new</i>
No		On/Off	Bianco	170145	27
			Nero	170152	27



LENS*

SINGLE CONNECTION



Light beam: ACCENT

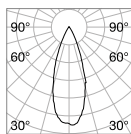

m	lx	Øm
1	8140	0,61
2	2035	1,22
3	904	1,82
4	509	2,43
5	326	3,04



CRI ≥ 80 25W 35° 2500lm 3000K

* La lente deve essere ordinata contestualmente al prodotto e verrà montata nel prodotto al posto della lente standard inclusa.



Eos new

Proiettore cilindrico in alluminio estruso con ottica simmetrica e fascio di apertura variabile da stretto ad ampio (20°-55°), adatto per installazione su binario trifase. Verniciatura a polveri in bianco o nero, testata girevole 355° e orientabile fino a 90°; il driver di alimentazione è incluso e trova alloggiamento nel corpo cilindrico del proiettore stesso. Disponibile anche in versione dimmerabile 1-10 V o DALI. Sorgente luminosa con tecnologia COB LED integrato, disponibile in due diverse potenze con una temperatura di colore di 3000K e con indice di resa cromatica ≥ 90 ; binning iniziale ≤ 3 Step MacAdam. Montaggio, smontaggio e regolazione dell'apertura del fascio senza utensili. Protezione IP20; durata utile LED 30.000 h L70B50. Ideale per l'illuminazione di grandi ambienti dove viene richiesta ampia flessibilità e alta resa cromatica, ad esempio aree ESPOSITIVE, spazi MUSEALI e RETAIL.

Sorgente	LED COB
Potenza	15W / 25W
Driver incluso	On/Off / 1-10V/ DALI
Driver disponibili	No
Binario	Trifase (standard Eutrac)
MacAdam	SDCM 3
CCT	3000 K
CRI	≥ 90
Durata LED	30.000 h
Classe isolamento	On-Off I, 1-10V / DALI II
IP	20
Materiale	Alluminio
Garanzia	5 anni

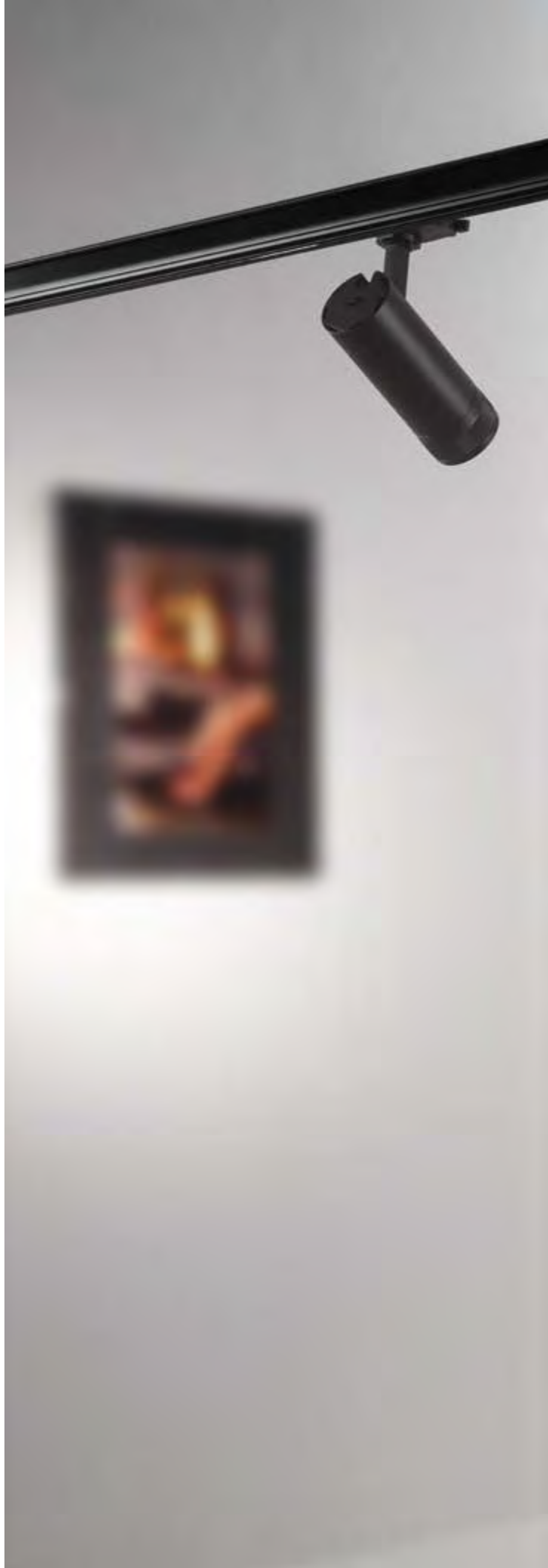

[Link - Pagina 650](#)

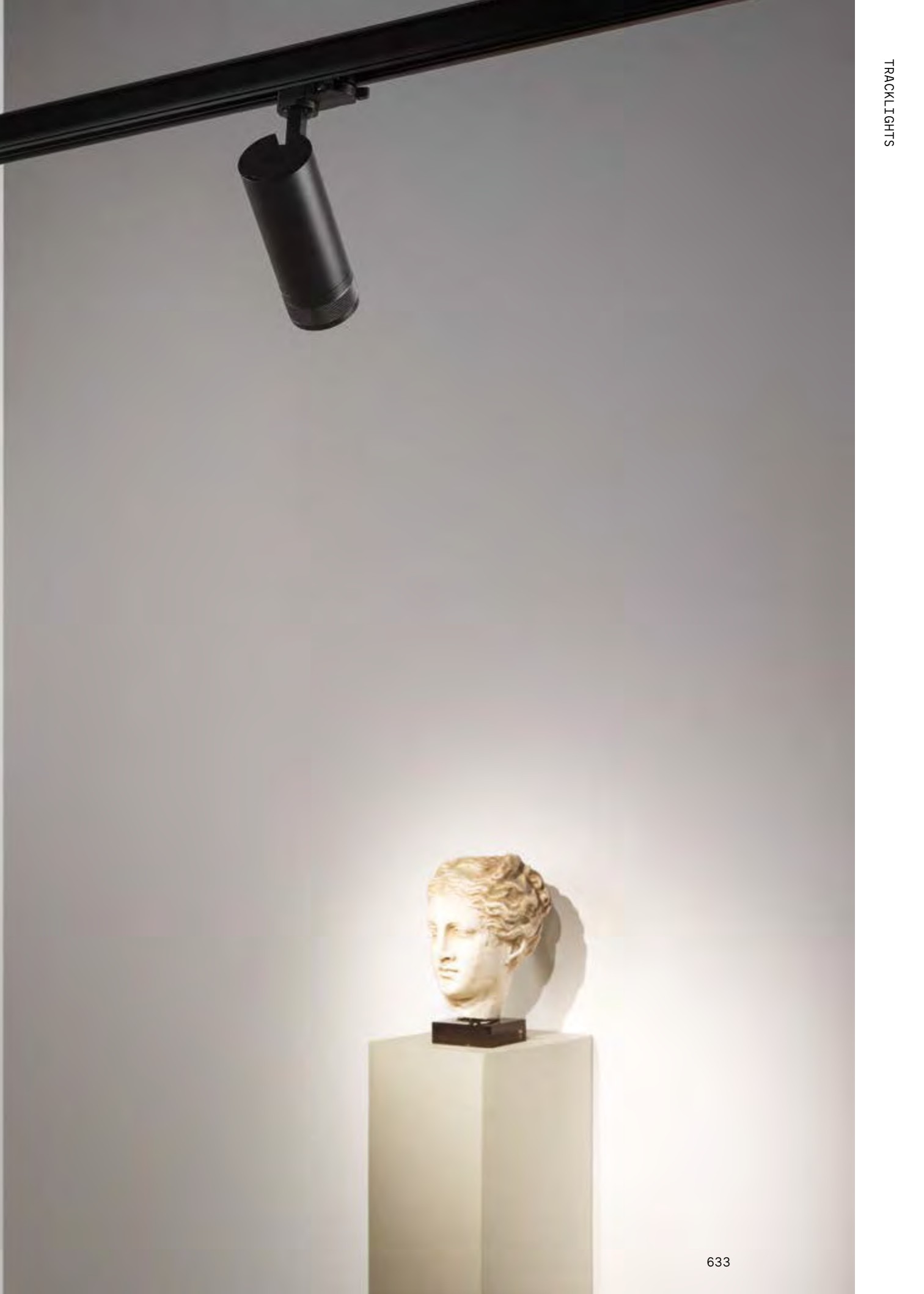



LED COB BRIDGELUX Driver incluso

Potenza	Angolo	Lumen	CCT	Driver	Finitura	Codice	€
14 W	20-55°	1550 lm	3000 K	On-Off	Bianco	286594	73
					Nero	276182	73
				1-10V	Bianco	302959	116 <i>new</i>
					Nero	302942	116 <i>new</i>
				DALI	Bianco	302997	135 <i>new</i>
					Nero	302980	135 <i>new</i>

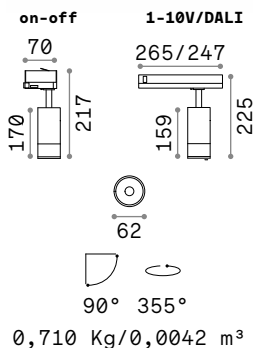

LED COB BRIDGELUX Driver incluso

Potenza	Angolo	Lumen	CCT	Driver	Finitura	Codice	€
25 W	20-55°	3000 lm	3000 K	On-Off	Bianco	286600	92
					Nero	276243	92
				1-10V	Bianco	302973	135 <i>new</i>
					Nero	302966	135 <i>new</i>
				DALI	Bianco	303017	155 <i>new</i>
					Nero	303000	155 <i>new</i>

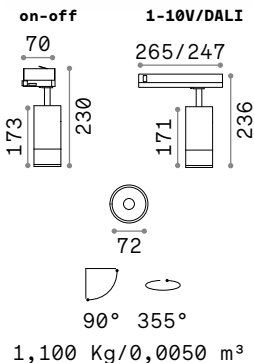

SINGLE CONNECTION

Necessario	Angolo	Driver	Finitura	Codice	€
No		On/Off	Bianco	170145	27
			Nero	170152	27



Light beam: from SPOT to WIDE

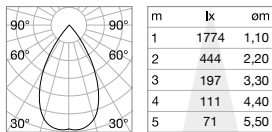

CRI≥90 15W 20-55° 1650lm 3000K

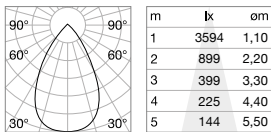

CRI≥90 25W 20-55° 3200lm 3000K

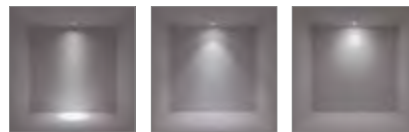





Sorgente	LED COB	CRI	≥95
Potenza	22W	Durata LED	30.000 h
Driver incluso	On/Off	Classe isolamento	II
Driver disponibili	No	IP	20
Binario	Trifase (standard Eutrac)	Materiale	Alluminio
MacAdam	SDCM 3	Garanzia	5 anni
CCT	3000 K		

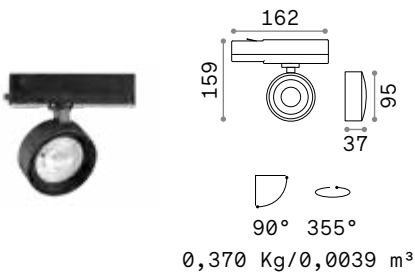

LED COB CREE Driver PHILIPS ON/OFF incluso

Potenza	Angolo	Lumen	CCT	Finitura	Codice	€
22 W	36°	1750 lm	3000 K	Bianco	296340	135 <small>new</small>
				Nero	296333	135 <small>new</small>

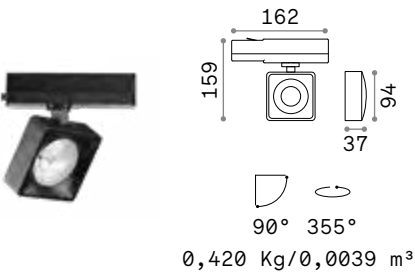

LED COB CREE Driver PHILIPS ON/OFF incluso

Potenza	Angolo	Lumen	CCT	Finitura	Codice	€
22 W	36°	1750 lm	3000 K	Bianco	296364	135 <small>new</small>
				Nero	296357	135 <small>new</small>



Link - Pagina 650



Light beam: ACCENT

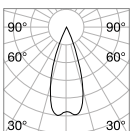

m	lx	Øm
1	3646	0,65
2	911	1,30
3	405	1,90
4	228	2,60
5	146	3,20



CRI≥95 22W 36° 1750lm 3000K





Spot - Mouse Track

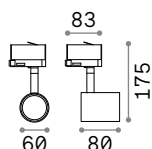

0,250 Kg/0,0016 m³

GU10 Non inclusa - Lampadina consigliata 108292

Potenza	Finitura	Codice	€
max 50W	Bianco	229706	44
	Nero	229720	44
	Ottone	269634	44



P. 310 P. 404

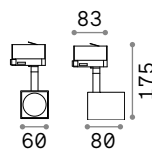

0,300 Kg/0,0027 m³

GU10 Non inclusa - Lampadina consigliata 108292

Potenza	Finitura	Codice	€
max 50W	Bianco	229768	44
	Nero	229782	44



P. 310 P. 404



SINGLE CONNECTION

Necessario	Driver	Finitura	Codice	€
No	On/Off	Bianco	170145	27
		Nero	170152	27



Link - Pagina 650



Byte **new**

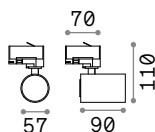

0,200 Kg/0,0013 m³

GU10 Non inclusa - Lampadina consigliata 123943



Potenza	Finitura	Codice	€
max 28W	Bianco	274508	36 new
	Nero	274515	36 new



SINGLE CONNECTION

Necessario	Driver	Finitura	Codice	€
No	On/Off	Bianco	170145	27
		Nero	170152	27



Link - Pagina 650



Glim - König Track new

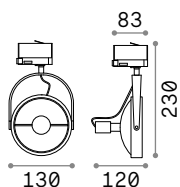

0,320 Kg/0,0180 m³

GU10 Lampadine LED GU10 10W 3000 K incluse. Cod. **189031**

Potenza	Finitura	Codice	€
max 50W	Bianco	229676	75
	Nero	229683	75



P. 313



P. 312

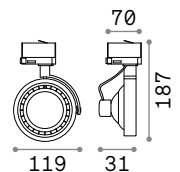

0,330 Kg/0,0035 m³

GU10 Lampadine LED GU10 10W 3000 K incluse. Cod. **189031**

Potenza	Finitura	Codice	€
max 50W	Bianco	284880	90 new
	Nero	284873	90 new



SINGLE CONNECTION

Necessario	Driver	Finitura	Codice	€
No	On/Off	Bianco	170145	27
		Nero	170152	27



Link - Pagina 650



Look Track

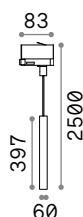

0,930 Kg/0,0037 m³

GU10 Lampadine LED GU10 7W 3000 K incluse. Cod. 123943



Potenza	Finitura	Codice	€
max 28W	Bianco	231662	83
	Nero	231631	83



P. 074 P. 298 P. 371



SINGLE CONNECTION

Necessario	Driver	Finitura	Codice	€
No	On/Off	Bianco	170145	27
		Nero	170152	27



Link - Pagina 650

Display

Proiettore lineare in alluminio adatto per installazione su binario trifase (standard Eutrac), disponibile in tre differenti lunghezze e con verniciatura a polveri in finitura bianca o nera. Il driver di alimentazione integrato è alloggiato all'interno del binario per minimizzare l'ingombro del prodotto visibile. Disponibile nel modello WIDE con ottica piatta e diffondente in PMMA satinato, nel modello UGR con diffusore in PMMA microprismatizzato per il controllo dell'abbagliamento e nel modello ACCENT con riflettori neri (UGR < 16). Sorgenti LED integrate; disponibile in CCT 3000 K e 4000 K; CRI ≥ 80; durata utile LED 50.000 h L70B50; montaggio e smontaggio senza utensili. Adatto per l'illuminazione di UFFICI, spazi COMMERCIALI e aree ESPOSITIVE, ideale in combinazione con altri proiettori da binario a luce focalizzata.

PRO Prodotto ad alto contenuto tecnologico, elevata qualità dei materiali, destinato ad uso professionale.

UGR Articolo con UGR <16 (Accent), <22 (UGR).

Sorgente	LED SMD
Potenza	14W / 40W
Driver incluso	On/Off
Driver disponibili	No
Binario	Trifase (standard Eutrac)
MacAdam	SDCM 3
CCT	3000 K / 4000 K
CRI	≥80
UGR	<16 (Accent) / <22 (UGR)
Durata LED	50.000 h
Classe isolamento	II
IP	20
Materiale	Alluminio
Garanzia	5 anni



[Link - Pagina 650](#)





Display Accent

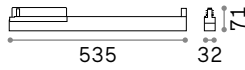

0,400 Kg/0,0064 m³

LED SMD SAMSUNG Driver ON/OFF incluso - UGR <16

Potenza	Angolo	Lumen	CCT	Finitura	Codice	€
14 W	60°	1800 lm	3000 K	Bianco	283593	210
				Nero	283609	210
		1900 lm	4000 K	Bianco	283616	210
				Nero	283623	210

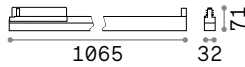

1,120 Kg/0,0112 m³

LED SMD SAMSUNG Driver ON/OFF incluso - UGR <16

Potenza	Angolo	Lumen	CCT	Finitura	Codice	€
28 W	60°	3500 lm	3000 K	Bianco	283524	330
				Nero	276267	330
		3700 lm	4000 K	Bianco	283531	330
				Nero	283548	330

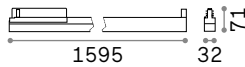

1,570 Kg/0,0173 m³

LED SMD SAMSUNG Driver ON/OFF incluso - UGR <16

Potenza	Angolo	Lumen	CCT	Finitura	Codice	€
40 W	60°	5300 lm	3000 K	Bianco	283555	455
				Nero	283562	455
		5600 lm	4000 K	Bianco	283579	455
				Nero	283586	455



Light beam: ACCENT

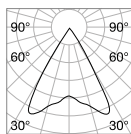

m	lx	Øm
1	1330	1,20
2	332	2,40
3	148	3,50
4	83	4,70
5	53	5,90



CRI≥80 14W 60° 1800lm 3000K

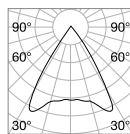

m	lx	Øm
1	2453	1,30
2	613	2,50
3	273	3,80
4	153	5,00
5	96	6,30



CRI≥80 28W 60° 3500lm 3000K

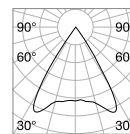

m	lx	Øm
1	3598	1,30
2	900	2,50
3	400	3,80
4	225	5,00
5	144	6,30



CRI≥80 40W 60° 5100lm 3000K



Display Accent 535 mm



Display Accent 1065 mm



Display Accent 1595 mm



Display Wide

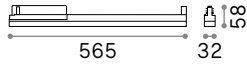

0,420 Kg/0,0067 m³

LED SMD SAMSUNG Driver ON/OFF incluso

Potenza	Angolo	Lumen	CCT	Finitura	Codice	€
21W	125°	2800 lm	3000 K	Bianco	283753	175
				Nero	283760	175
		2850 lm	4000 K	Bianco	276274	175
				Nero	283777	175

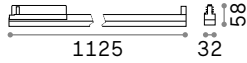

0,770 Kg/0,0124 m³

LED SMD SAMSUNG Driver ON/OFF incluso

Potenza	Angolo	Lumen	CCT	Finitura	Codice	€
40W	125°	5750 lm	3000 K	Bianco	283722	265
				Nero	283050	265
		5850 lm	4000 K	Bianco	283739	265
				Nero	283746	265



Light beam: WIDE

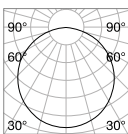

m	lx	Øm
1	473	5,20
2	118	6,50
3	53	9,70
4	30	13,00
5	19	16,00

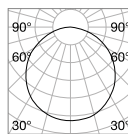
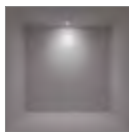

m	lx	Øm
1	897	3,10
2	224	6,10
3	100	9,20
4	56	12,00
5	36	15,00



CRI≥80 21W 125° 2400lm 3000K

CRI≥80 40W 125° 4300lm 3000K



Display Wide 565 mm



Display Wide 1125 mm



Display UGR

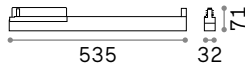

0,400 Kg/0,0064 m³

LED SMD SAMSUNG Driver ON/OFF incluso - UGR <22

Potenza	Angolo	Lumen	CCT	Finitura	Codice	€
14 W	70°	2000 lm	3000 K	Bianco	283685	185
				Nero	283692	185
		2100 lm	4000 K	Bianco	283708	185
				Nero	283715	185

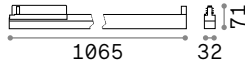

1,120 Kg/0,0112 m³

LED SMD SAMSUNG Driver ON/OFF incluso - UGR <22

Potenza	Angolo	Lumen	CCT	Finitura	Codice	€
27 W	70°	4000 lm	3000 K	Bianco	283647	290
				Nero	283630	290
		4300 lm	4000 K	Bianco	276281	290
				Nero	283258	290

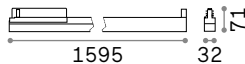

1,570 Kg/0,0173 m³

LED SMD SAMSUNG Driver ON/OFF incluso - UGR <22

Potenza	Angolo	Lumen	CCT	Finitura	Codice	€
40 W	70°	6050 lm	3000 K	Bianco	283654	410
				Nero	283067	410
		6450 lm	4000 K	Bianco	283661	410
				Nero	283678	410



Light beam: WIDE

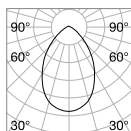

m	lx	Øm
1	854	1,40
2	213	2,80
3	95	4,20
4	53	5,70
5	34	7,10

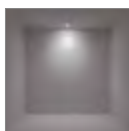

CRI≥80 14W 70° 1600lm 3000K

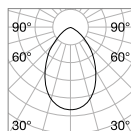

m	lx	Øm
1	1636	1,40
2	409	2,80
3	182	4,20
4	102	5,70
5	65	7,10



CRI≥80 27W 70° 3100lm 3000K

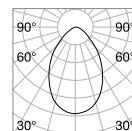

m	lx	Øm
1	2419	1,40
2	605	2,80
3	269	4,20
4	151	5,70
5	97	7,10

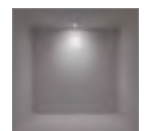

CRI≥80 40W 70° 4500lm 3000K

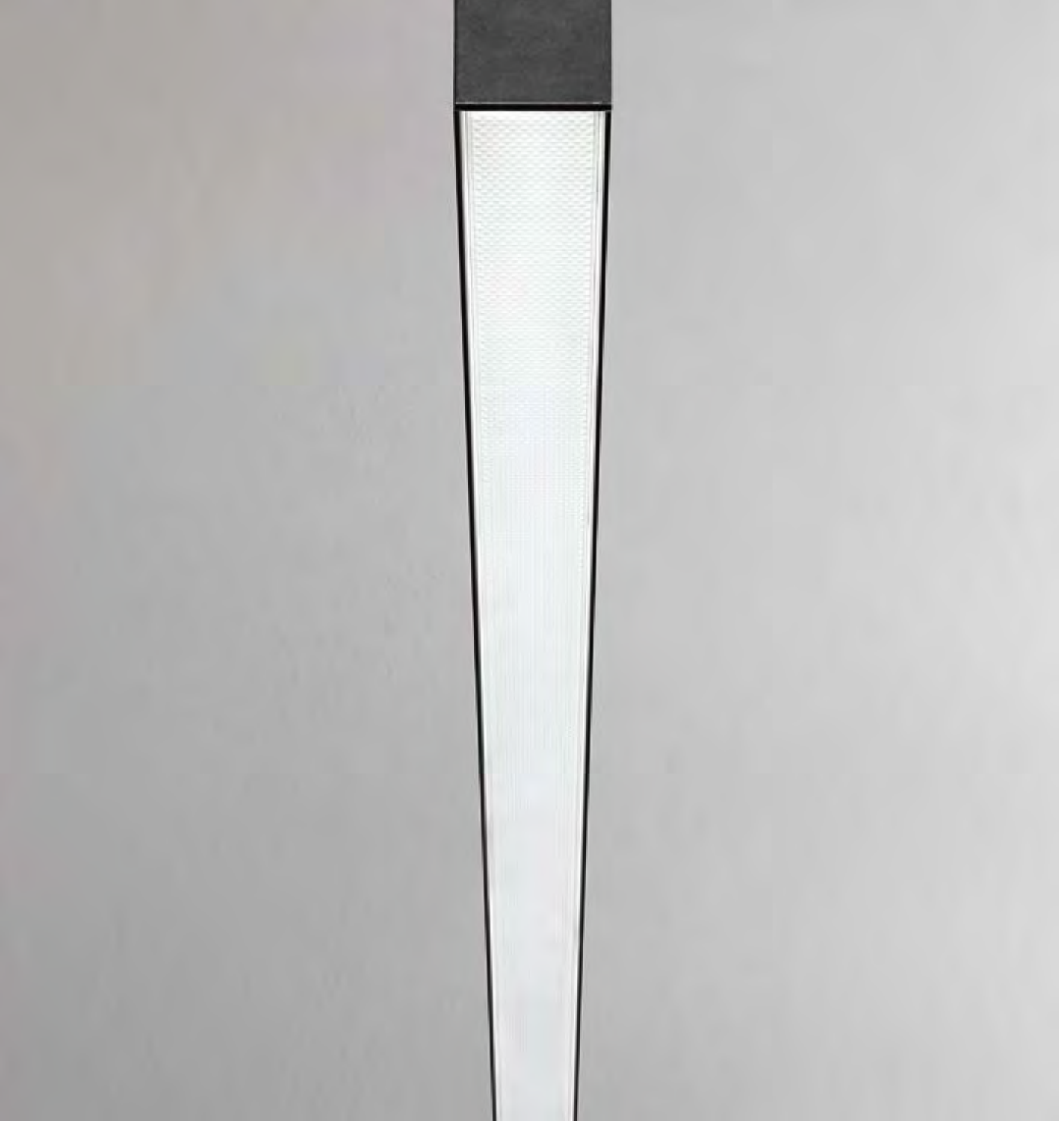

Display UGR 535 mm



Display UGR 1065 mm



Display UGR 1595 mm



Link

Profilo di alluminio estruso per binari elettrificati trifase; verniciatura a polveri in bianco o nero, ottimizzato per proiettori standard Eutrac; disponibile nelle versioni a plafone, a sospensione oppure a incasso a filo su soffitti di cartongesso; adatto a sistemi di file continue, moduli standard da 2000 mm o 3000 mm. Ideale per l'installazione in grandi ambienti dove viene richiesta grande flessibilità, ad esempio spazi MUSEALI, COMMERCIALI e RETAIL. Garanzia 5 anni.





Link Trimless On/Off

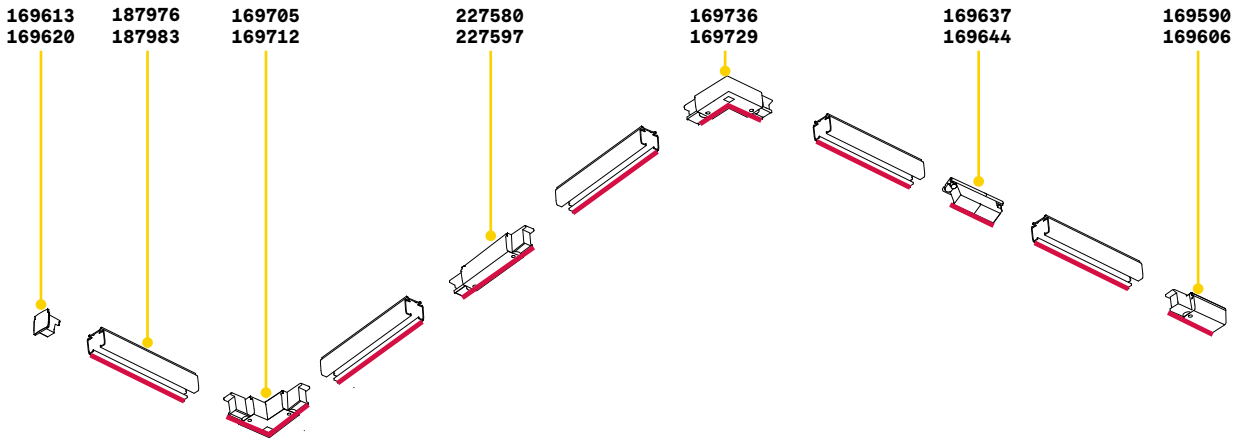

TRACK

Lunghezza	Peso	Volume	Finitura	Codice	€
1000 mm	0,94 Kg	0,0016 m ³	Bianco	243269	33
			Nero	243252	33
2000 mm	1,93 Kg	0,0032 m ³	Bianco	187976	64
			Nero	187983	64
3000 mm	2,87 Kg	0,0048 m ³	Bianco	187990	100
			Nero	188003	100



KIT SURFACE



SUSPENSION KIT

Necessario	N° Cavi	Lunghezza cavi	Finitura	Codice	€
SI - 1Kitx 1000 mm			Bianco	169972	7
			Nero	169989	7
SI - 1Kitx 1000 mm	1	3000 mm	Bianco	242705	16
			Nero	243283	16
	1	5000 mm	Bianco	243245	18
			Nero	243238	18



MAIN CONNECTOR END

0,060 Kg/0,0002 m³

169583	L	€ 16
169576	R	€ 16
169590	L	€ 16
169606	R	€ 16

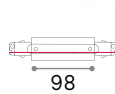

MAIN CONNECTOR MIDDLE

0,120 Kg/0,0004 m³

227580	€ 25
227597	€ 25

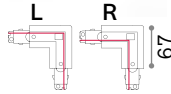

MAIN CONNECTOR CORNER

0,110 Kg/0,0005 m³

169705	L	€ 25
169712	R	€ 25
169736	L	€ 25
169729	R	€ 25

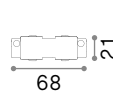

ELECTRIFIED CONNECTOR

0,030 Kg/0,0001 m³

169637	€ 8
169644	€ 8



END CAP

0,010 Kg/0,0001 m³

169613	€ 4
169620	€ 4

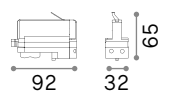

TRACK ADAPTOR

0,080 Kg/0,0002 m³

194257	€ 12
194301	€ 12

Link Trimless DALI - 1-10V

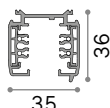
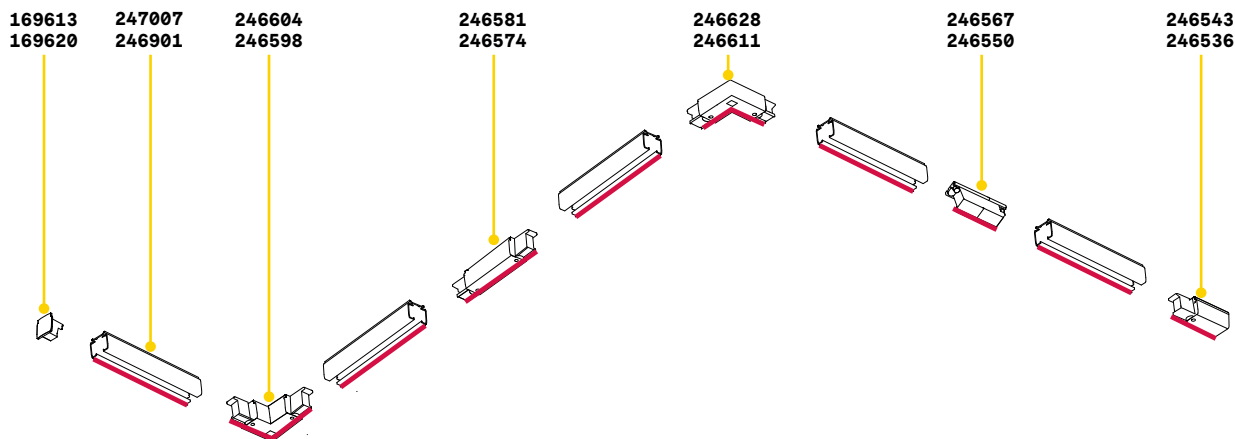

TRACK

Lunghezza	Peso	Volume	Finitura	Codice	€
1000 mm	0,94 Kg	0,0016 m³	Bianco	246468	37
			Nero	246451	37
2000 mm	1,93 Kg	0,0032 m³	Bianco	247007	70
			Nero	246901	70
3000 mm	2,87 Kg	0,0048 m³	Bianco	247625	103
			Nero	247618	103



KIT SURFACE



SUSPENSION KIT

Necessario	N° Cavi	Lunghezza cavi	Finitura	Codice	€
SI - 1 Kit x 1000 mm			Bianco	169972	7
			Nero	169989	7
SI - 1 Kit x 1000 mm	1	3000 mm	Bianco	242705	16
			Nero	243283	16
	1	5000 mm	Bianco	243245	18
			Nero	243238	18

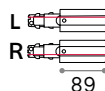

MAIN CONNECTOR END

0,079 Kg/0,0002 m³

246529	L	€ 17
246512	R	€ 17
246543	R	€ 17
246536	R	€ 17

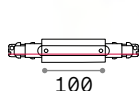

MAIN CONNECTOR MIDDLE

0,129 Kg/0,0004 m³

246581	€ 28
246574	€ 28

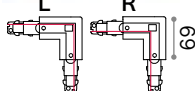

MAIN CONNECTOR CORNER

0,130 Kg/0,0006 m³

246604	L	€ 29
246598	R	€ 29
246628	R	€ 29
246611	R	€ 29

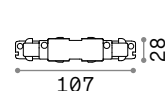

ELECTRIFIED CONNECTOR

0,041 Kg/0,0001 m³

246567	€ 12
246550	€ 12



END CAP

0,010 Kg/0,0001 m³

169613	€ 4
169620	€ 4

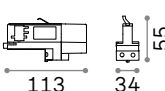

TRACK ADAPTOR

0,063 Kg/0,0003 m³

246505	€ 20
246499	€ 20

Link Trim On/Off

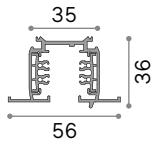
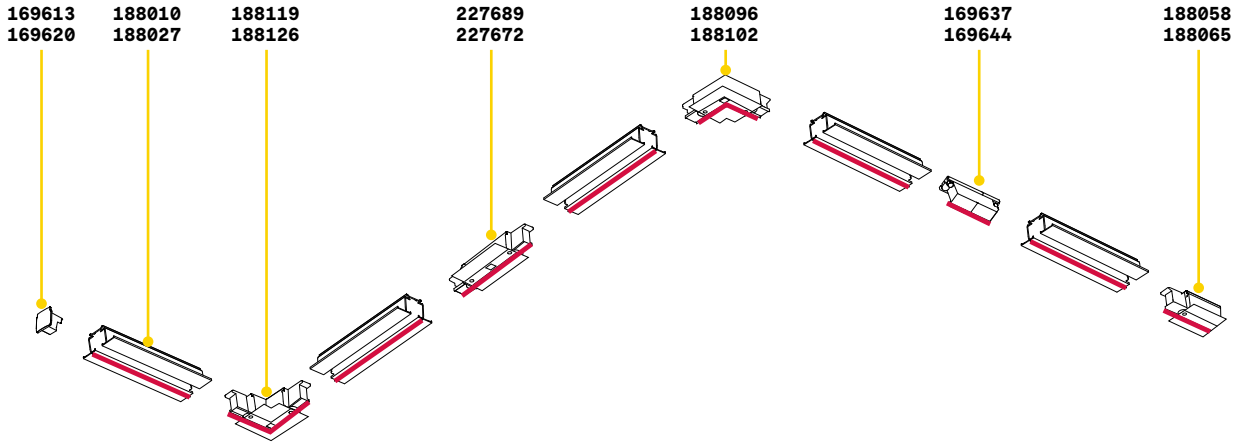

TRACK

Lunghezza	Peso	Volume	Finitura	Codice	€
2000 mm	2,11 Kg	0,0048 m ³	Bianco	188010	68
			Nero	188027	68



KIT RECESSED

Necessario	Codice	€
SI - 1Kitx 1000 mm	188195	6

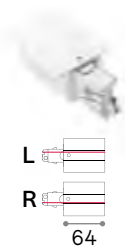

MAIN CONNECTOR END

0,070 Kg/0,0002 m³

188072	L	€ 18
188089	L	€ 18
188058	R	€ 18
188065	R	€ 18



MAIN CONNECTOR MIDDLE

0,130 Kg/0,0004 m³

227689	€ 29
227672	€ 29

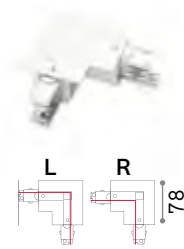

MAIN CONNECTOR CORNER

0,120 Kg/0,0006 m³

188119	L	€ 28
188126	L	€ 28
188096	R	€ 28
188102	R	€ 28



ELECTRIFIED CONNECTOR

0,030 Kg/0,0001 m³

169637	€ 8
169644	€ 8



END CAP

0,010 Kg/0,0001 m³

169613	€ 4
169620	€ 4

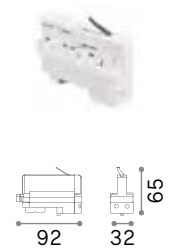

TRACK ADAPTOR

0,080 Kg/0,0002 m³

194257	€ 12
194301	€ 12

Link Trim DALI - 1-10V

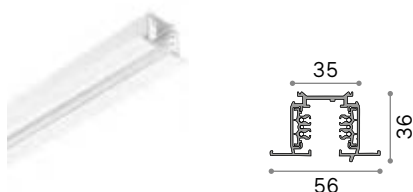
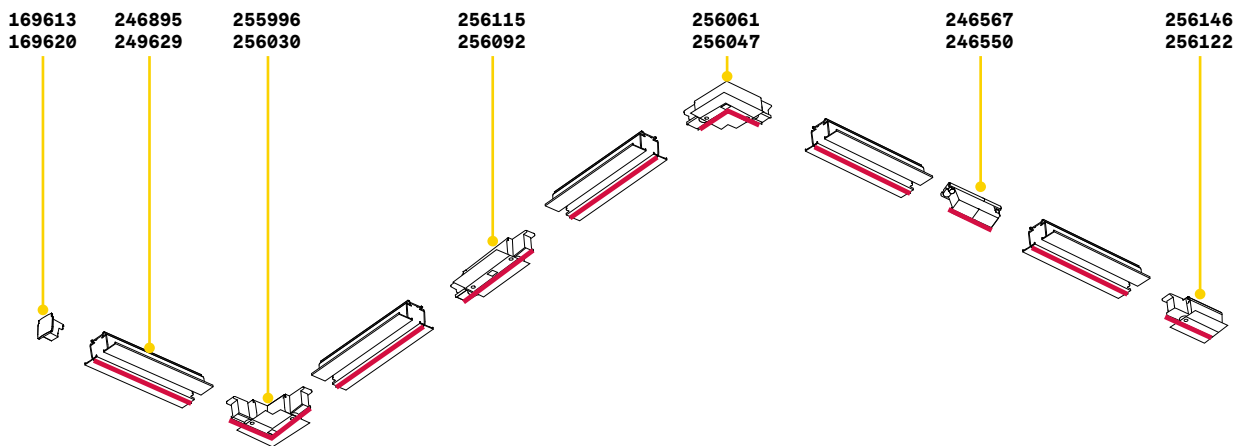

TRACK

Lunghezza	Peso	Volume	Finitura	Codice	€
2000 mm	2,11 Kg	0,0048 m ³	Bianco	246895	76
			Nero	249629	76



KIT RECESSED

Necessario	Codice	€
SI - 1 Kit x 1000 mm	188195	6

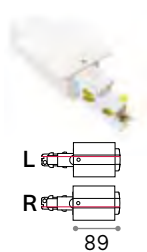

MAIN CONNECTOR END

0,089 Kg/0,0004 m³

- 256085 L € 19
- 256078 R € 19
- 256146 L € 19
- 256122 R € 19



MAIN CONNECTOR MIDDLE

0,145 Kg/0,0005 m³

- 256115 L € 31
- 256092 R € 31

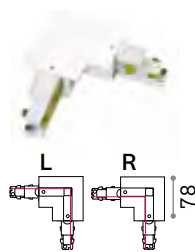

MAIN CONNECTOR CORNER

0,143 Kg/0,0006 m³

- 256030 L € 31
- 255996 R € 31
- 256061 L € 31
- 256047 R € 31



ELECTRIFIED CONNECTOR

0,041 Kg/0,0001 m³

- 246567 L € 12
- 246550 R € 12



END CAP

0,010 Kg/0,0001 m³

- 169613 L € 4
- 169620 R € 4



TRACK ADAPTOR

0,063 Kg/0,0003 m³

- 246505 L € 20
- 246499 R € 20































Interni

Lampade da incasso

Indice alfabetico

Basic	688
Bento	658
Blues	716
Channel	699
Deep	686
Dynamic	664
Eye	710
Funky	714
Galileo	710
Game	672
Groove	694
Jazz	714
Led Panel	702
Lika	704
Lounge	714
Nova	700
Off	682
One	678
Play	698
Polka	718
Quark	681
Room-65	715
Samba	712
Soul	717
Swing	714
Virus	680
Walky	719
Zephyr	711

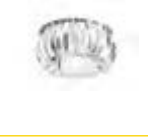
Indice icone

				
Bento 658	Dynamic 664	Game 672	One 678	Virus 680
				
Quark 681	Off 682	Deep 686	Basic 688	Groove 694
				
Play 698	Channel 699	Nova 700	Led Panel 702	Lika 704
<small>new</small> 				
Galileo 710	Eye 710	Zephyr 711	Samba 712	Jazz 714
				
Swing 714	Lounge 714	Funky 714	Room-65 715	Blues 716
				
Soul 717	Soul 717	Polka 718	Walky 719	

Bento

Sistema componibile di elementi ad incasso costituito da sorgente orientabili, riflettore e ghiera, con lenti e accessori schermanti in opzione; finitura bianca e nera; ghiera a incasso disponibile in forma singola rotonda o quadrata, oppure rettangolare in versione doppia o tripla per l'installazione di sorgenti multiple e indipendenti; anello anti-abbagliamento opzionale per arretramento della sorgente in modalità non orientabile; tre diversi angoli di emissione a scelta. Sorgente luminosa con tecnologia COB LED integrato per la massima efficienza, disponibile con una temperatura di colore di 3000 K; LED ad efficienza energetica ad elevata resa cromatica; CRI ≥ 90 ; binning iniziale ≤ 3 -Step MacAdam; classe isolamento II; durata utile LED 50.000 h L70B50. Disponibile in versione dimmerabile sia DALI che 1-10V. Per la sua dimensione compatta e grande versatilità è ottimale nelle installazioni di ambienti interni DOMESTICI, DIREZIONALI e RETAIL.

PRO

Prodotto ad alto contenuto tecnologico, elevata qualità dei materiali, destinato ad uso professionale.

UGR





Articolo con UGR <19.

Sorgente	LED COB
Potenza	9W / 13W
Driver incluso	On/Off
Driver disponibili	1-10V / DALI / Push
MacAdam	SDCM 3
CCT	3000 K
CRI	≥ 90
UGR	<19
Durata LED	50.000 h
Classe isolamento	II
IP	20
Materiale	Alluminio
Garanzia	5 anni

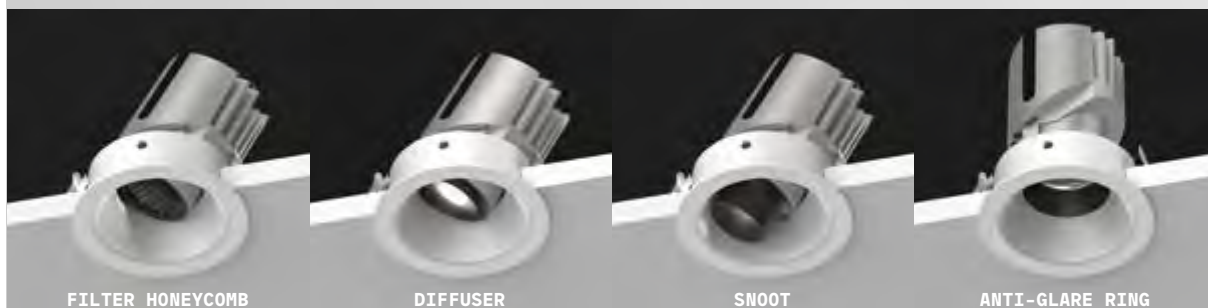





		Necessario	Angolo	Finitura	Codice	€
	LENS	No	18°	Trasparen.	287942	4
			45°	Trasparen.	279626	4
	FILTER HONEYCOMB	No		Nero	279718	4
	DIFFUSER	No		Nero	279725	3
	SNOOT	No		Nero	279701	4
	ANTI-GLARE RING	No		Bianco	288147	3
				Nero	279695	3

Bento - Source

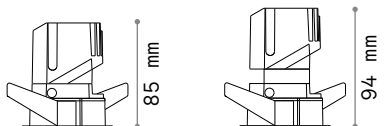

with anti-glare ring

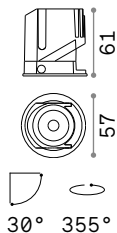

0,180 Kg/0,0003 m³

LED COB CITIZEN Necessario - Driver TRIDONIC ON/OFF incluso

Potenza	Angolo	Lumen	CCT	Finitura	Codice	€
9W	36°	730 lm	3000 K	Nero	279596	45

DIMMABLE DRIVER* Optional

	Potenza	Output	Misura (LxHxP)	Codice	€
1-10V	12 W	250 mA	122x25x40 mm	287843	58
DALI / Push	20 W	250 mA	120x29x51 mm	287850	87

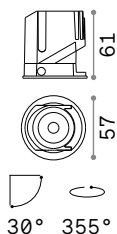

0,200 Kg/0,0003 m³

LED COB CITIZEN Necessario - Driver TRIDONIC ON/OFF incluso

Potenza	Angolo	Lumen	CCT	Finitura	Codice	€
13 W	36°	1000 lm	3000 K	Nero	279602	50

DIMMABLE DRIVER* Optional

	Potenza	Output	Misura (LxHxP)	Codice	€
1-10V / Push	20 W	350 mA	108x22x52 mm	287867	75
DALI / Push	20 W	350 mA	120x29x51 mm	287874	80



Light beam: ACCENT

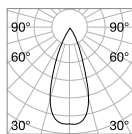

m	lx	øm
1	1312	0,71
2	328	1,40
3	146	2,10
4	82	2,80
5	52	3,50



CRI≥90 9W 36° 850lm 3000K

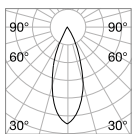

m	lx	øm
1	1846	0,65
2	461	1,30
3	205	1,90
4	115	2,60
5	74	3,20

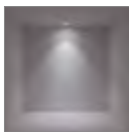

CRI≥90 13W 36° 1100lm 3000K

* Gli alimentatori dimmerabili devono essere ordinati contestualmente al prodotto e verranno già inclusi all'interno degli apparecchi in sostituzione degli alimentatori on-off.
** Lente 36° inclusa.

Bento - Frame and Reflector

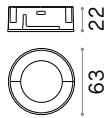

0,020 Kg/0,0001 m³

ROUND - REFLECTOR Necessario

Finitura	Codice	€
Bianco	279633	6
Nero	279640	6

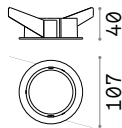

Ⓜ 68 mm

0,060 Kg/0,0007 m³

ROUND - FRAME SINGLE Necessario

Finitura	Codice	€
Bianco	287898	12
Nero	287881	12

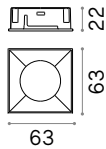

0,020 Kg/0,0001 m³

SQUARE - REFLECTOR Necessario

Finitura	Codice	€
Bianco	279671	8
Nero	279688	8

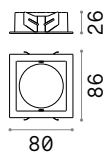

Ⓜ 68 x 68 mm

0,050 Kg/0,0002 m³

SQUARE - FRAME SINGLE Necessario

Finitura	Codice	€
Bianco	287911	14
Nero	287904	14

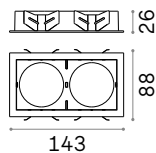

Ⓜ 134 x 71 mm

0,110 Kg/0,0004 m³

SQUARE - FRAME TWIN Necessario

Finitura	Codice	€
Bianco	287935	24
Nero	280233	24

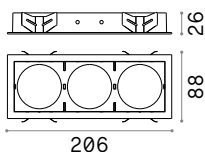

Ⓜ 197 x 71 mm

0,300 Kg/0,0006 m³

SQUARE - FRAME TRIPLE Necessario

Finitura	Codice	€
Bianco	287928	30
Nero	280240	30

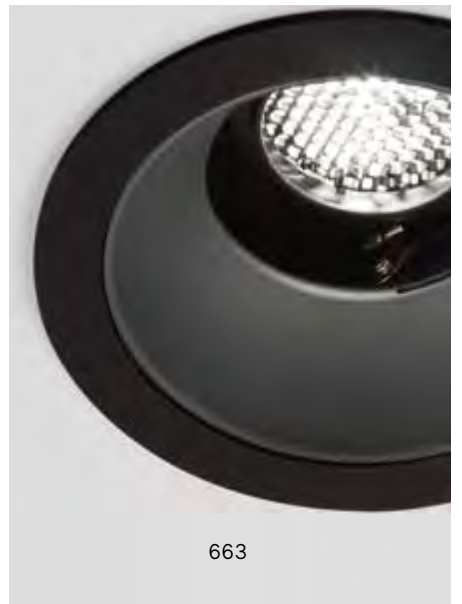

Dynamic

Sistema componibile di elementi ad incasso in alluminio costituito da sorgente, riflettore e ghiera, con lenti e schermi in opzione; finitura bianca, cromo, nera, oro; incasso possibile di forma rotonda o quadrata, riflettore simmetrico o asimmetrico; tre diversi angoli di emissione a scelta. Sorgente luminosa con tecnologia COB LED integrato per la massima efficienza, disponibile con una temperatura di colore di 2700 K, 3000 K o 4000 K; LED ad efficienza energetica ad elevata resa cromatica; CRI ≥ 90 ; binning iniziale ≤ 3 -Step MacAdam; protezione frontale IP54 (a prodotto installato); classe isolamento II; durata utile LED 50.000 h L70B50. Disponibile in versione dimmerabile sia DALI che 1-10V. Per la sua dimensione compatta e grande versatilità è ottimale nelle installazioni di ambienti interni DOMESTICI, DIREZIONALI e RETAIL.

PRO Prodotto ad alto contenuto tecnologico, elevata qualità dei materiali, destinato ad uso professionale.









UGR Articolo con UGR <19.

IP54 Grado di protezione IP54.

Sorgente	LED COB
Potenza	9W / 10W / 15W
Driver incluso	On/Off
Driver disponibili	1-10V / DALI / Push
MacAdam	SDCM 3
CCT	2700 K / 3000 K / 4000 K
CRI	≥ 90
UGR	<19
Durata LED	50.000 h
Classe isolamento	II
IP	54
Materiale	Alluminio
Garanzia	5 anni





		Necessario	Angolo	Finitura		Codice	€
	LENS	No	20°	Trasparen.		211763	7
			55°	Trasparen.		211770	7
	FILTER HONEYCOMB	No		Nero		208671	7
	FILTER ELLIPTICAL	No		Trasparen.		208688	7
	GU10 ADAPTOR WITH LAMPHOLDER INCLUDED - IP20	No		Bianco		208640	16
			Nero		208657	16	



Light beam: ACCENT

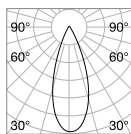

m	lx	Øm
1	1653	0,72
2	413	1,44
3	184	2,16
4	103	2,88
5	66	3,60



CRI≥90 9W 35° 10001m 3000K

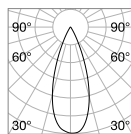

m	lx	Øm
1	1643	0,66
2	410	1,32
3	182	1,98
4	102	2,64
5	65	3,30



CRI≥90 10W 35° 12501m 3000K

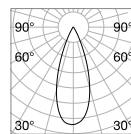

m	lx	Øm
1	2294	0,64
2	573	1,29
3	254	1,93
4	143	2,58
5	91	3,23



CRI≥90 15W 35° 16001m 3000K

Dynamic - Source

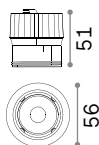

0,180 Kg/0,0030 m³

LED COB CITIZEN Necessario - Driver TRIDONIC ON/OFF incluso

Potenza	Angolo	Lumen	CCT	Finitura	Codice	€
9W	35°	840 lm	2700 K	Nero	252971	45
		870 lm	3000 K	Nero	252988	45
		1000 lm	4000 K	Nero	252995	45

DIMMABLE DRIVER* Optional

	Potenza	Output	Misura (LxHxP)	Codice	€
1-10V	12 W	200 mA	125x27x45 mm	253008	45
DALI	20 W	200 mA	135x20x30 mm	253015	65

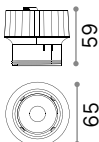

0,150 Kg/0,0030 m³

LED COB CITIZEN Necessario - Driver TRIDONIC ON/OFF incluso

Potenza	Angolo	Lumen	CCT	Finitura	Codice	€
10 W	35°	970 lm	2700 K	Nero	208541	65
		1000 lm	3000 K	Nero	208558	65
		1100 lm	4000 K	Nero	208565	65

DIMMABLE DRIVER* Optional

	Potenza	Output	Misura (LxHxP)	Codice	€
1-10V	10 W	250 mA	135x20x30 mm	216317	25
DALI/Push	17 W	250 mA	130x30x43 mm	216027	110

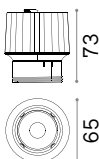

0,200 Kg/0,0030 m³

LED COB CITIZEN Necessario - Driver TRIDONIC ON/OFF incluso

Potenza	Angolo	Lumen	CCT	Finitura	Codice	€
15 W	35°	1500 lm	2700 K	Nero	208572	90
		1150 lm	3000 K	Nero	208589	90
		1650 lm	4000 K	Nero	208596	90

DIMMABLE DRIVER* Optional

	Potenza	Output	Misura (LxHxP)	Codice	€
1-10V	20 W	350 mA	101x29x51 mm	216324	50
DALI/Push	17 W	350 mA	130x30x43 mm	216263	115

* Gli alimentatori dimmerabili devono essere ordinati contestualmente al prodotto e verranno già inclusi all'interno degli apparecchi in sostituzione degli alimentatori on-off. ** Lente 35° inclusa.

Dynamic Round

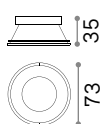
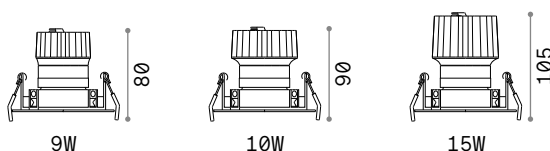

0,020 Kg/0,0002 m³

REFLECTOR Necessario

SIMMETRICO

Finitura	Codice	€
Bianco	211787	8
Cromo	221649	8
Nero	211794	8
Oro	211800	8

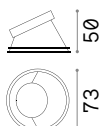

0,020 Kg/0,0002 m³

ASIMMETRICO - 30°

Finitura	Codice	€
Bianco	211848	8
Cromo	221663	8
Nero	211855	8
Oro	211862	8

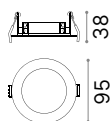

⌀ 80 mm

0,060 Kg/0,0004 m³

FRAME Necessario

Finitura	Codice	€
Bianco	208695	17
Cromo	221687	17
Nero	208701	17
Oro	208718	17



Dynamic Square

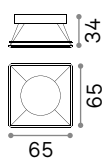
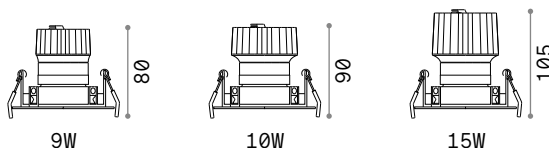

0,020 Kg/0,0002 m³

REFLECTOR Necessario

SIMMETRICO

Finitura	Codice	€
Bianco	211817	8
Cromo	221656	8
Nero	211824	8
Oro	211831	8

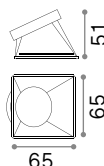

0,020 Kg/0,0002 m³

ASIMMETRICO - 30°

Finitura	Codice	€
Bianco	211879	8
Cromo	221670	8
Nero	211886	8
Oro	211893	8

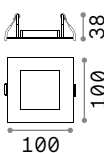

① 90 mm
0,050 Kg/0,0004 m³

FRAME Necessario

Finitura	Codice	€
Bianco	208725	19
Cromo	221694	19
Nero	208732	19
Oro	208749	19

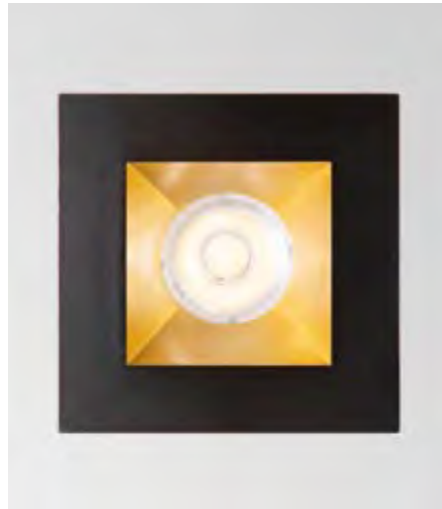

Game

Faretto ad incasso in alluminio pressofuso con ghiera rotonda o quadrata, adatto per installazione su soffitti in cartongesso.

Finitura cromata opaca, bianca opaca RAL 9001, nera opaca RAL 9011, oro opaca RAL 1032. Tecnologia COB-Chip On Board per la massima efficienza; disponibile in temperatura di colore 2700 K, 3000 K o 4000 K. Montaggio e smontaggio senza utensili; protezione IP20; classe isolamento II; durata utile LED 50.000 h L70B50. In opzione dimmerabile 1-10V e DALI.



Articolo con UGR <19.

Sorgente	LED COB
Potenza	11W / 20W
Driver incluso	On/Off
Driver disponibili	1-10V / DALI
CCT	2700 K / 3000 K / 4000 K
CRI	≥80 / ≥90
UGR	<19
Durata LED	50.000 h
Classe isolamento	II
IP	20
Materiale	Alluminio
Garanzia	5 anni





Game Round

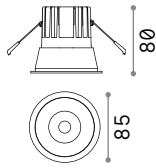

⌀ 74 mm
0,280 Kg/0,0011 m³

LED COB CREE Driver ON/OFF incluso - CRI ≥80

Potenza	Angolo	Lumen	CCT	Finitura	Codice	€
11W	36°	1000 lm	2700 K	Bianco +	285429	47
		1100 lm	3000 K	Argento +	192284	47
				Bianco +	192291	47
				Nero +	192277	47
				Oro +	192307	47
		1250 lm	4000 K	Bianco +	267975	47

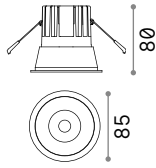

⌀ 74 mm
0,280 Kg/0,0011 m³

LED COB CREE Driver ON/OFF incluso - CRI ≥80

Potenza	Angolo	Lumen	CCT	Finitura	Codice	€
11W	36°	1000 lm	2700 K	Nero +	285412	47
		1100 lm	3000 K	Argento +	192321	47
				Bianco +	192338	47
				Nero +	192314	47
				Oro +	192345	47
		1250 lm	4000 K	Nero +	267968	47

DIMMABLE DRIVER* Optional

	Potenza	Output	Misura (L x H x P)	Codice	€
1-10V	12W	250 mA	150 x 29 x 43 mm	217253	40
DALI	11W	250 mA	135 x 20 x 30 mm	202396	60

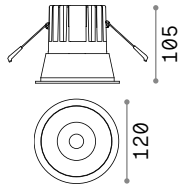

⌀ 110 mm
0,660 Kg/0,0033 m³

LED COB BRIDGELUX Driver ON/OFF incluso - CRI ≥90

Potenza	Angolo	Lumen	CCT	Finitura	Codice	€
20W	24°	2350 lm	3000 K	Bianco +	273174	90
				Nero +	273167	90



Light beam: **ACCENT**



Light beam: **SPOT**

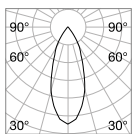

m	lx	cm
1	1545	0,69
2	386	1,38
3	171	2,07
4	96	2,77
5	61	3,46

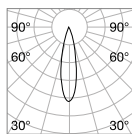

m	lx	cm
1	8645	0,41
2	2161	0,83
3	961	1,20
4	540	1,70
5	346	2,10



CRI≥90 11W 36° 8501m 3000K

CRI≥90 20W 24° 18501m 3000K

* Gli alimentatori dimmerabili devono essere ordinati contestualmente al prodotto e verranno già inclusi all'interno degli apparecchi in sostituzione degli alimentatori on-off.



Game Square

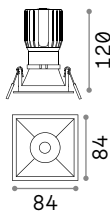

75 x 75 mm
0,270 Kg/0,0011 m³

LED COB CREE Driver ON/OFF incluso - CRI ≥ 80

Potenza	Angolo	Lumen	CCT	Finitura	Codice	€
11W	36°	1000 lm	2700 K	Bianco +	285443	47
		1100 lm	3000 K	Bianco +	192376	47
				Nero +	192352	47

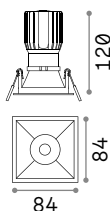

75 x 75 mm
0,270 Kg/0,0011 m³

LED COB CREE Driver ON/OFF incluso - CRI ≥ 80

Potenza	Angolo	Lumen	CCT	Finitura	Codice	€
11W	36°	1000 lm	2700 K	Nero +	285436	47
		1100 lm	3000 K	Bianco +	192406	47
				Nero +	192383	47

DIMMABLE DRIVER* Optional

	Potenza	Output	Misura (LxHxP)	Codice	€
1-10V	12 W	250 mA	150 x 29 x 43 mm	217253	40
DALI	11W	250 mA	135 x 20 x 30 mm	202396	60



Light beam: ACCENT

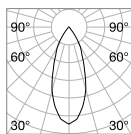

m	lx	Øm
1	1545	0,69
2	386	1,38
3	171	2,07
4	96	2,77
5	61	3,46



CRI ≥ 90 11W 36° 850lm 3000K

* Gli alimentatori dimmerabili devono essere ordinati contestualmente al prodotto e verranno già inclusi all'interno degli apparecchi in sostituzione degli alimentatori on-off.



One

Sorgente	LED SMD	Durata LED	30.000 h
Potenza	2W / 3W	Classe isolamento	II
Driver incluso	On/Off	IP	20
Driver disponibili	No	Materiale	Alluminio
CCT	3000 K	Garanzia	5 anni
CRI	≥90		

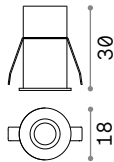

⌀ 17 mm

0,050 Kg/0,0001 m³

LED SMD Driver ON/OFF incluso*

Potenza	Angolo	Lumen	CCT	Finitura	Codice	€
2W	23°	130 lm	3000 K	Bianco	274768	31

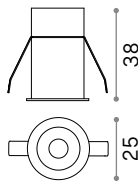

⌀ 25 mm

0,070 Kg/0,0001 m³

LED SMD Driver ON/OFF incluso*

Potenza	Angolo	Lumen	CCT	Finitura	Codice	€
2W	30°	130 lm	3000 K	Bianco	274775	37

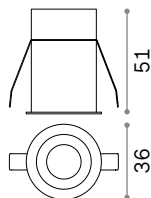

⌀ 35 mm

0,100 Kg/0,0003 m³

LED SMD Driver ON/OFF incluso*

Potenza	Angolo	Lumen	CCT	Finitura	Codice	€
3W	23°	270 lm	3000 K	Bianco	274782	41



Light beam: SPOT

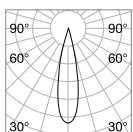

m	lx	Øm
1	372	0,40
2	93	0,81
3	41	1,20
4	23	1,60
5	15	2,00



CRI≥90 2W 25° 651m 3000K



Light beam: SPOT

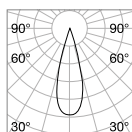

m	lx	Øm
1	307	0,53
2	77	1,10
3	34	1,60
4	19	2,10
5	12	2,70



CRI≥90 2W 30° 701m 3000K



Light beam: SPOT

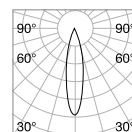

m	lx	Øm
1	866	0,40
2	216	0,80
3	96	1,20
4	54	1,60
5	35	2,00



CRI≥90 3W 25° 651m 3000K

* Misure L 38,3 x H 16,5 x P 19,3 mm





Virus

☐ IP20 CRI≥90 50.000 h ALLUMINIO

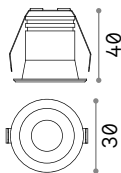

Ⓢ 30 mm

0,070 Kg/0,0003 m³

LED SMD OSRAM AND DRIVER Incluso

Potenza	Angolo	Lumen	CCT	Finitura	Codice	€
3W	20°	210 lm	3000 K	Bianco +	244808	32
				Oro +	244822	32
				Nero +	244846	32
				Oro +	244853	32



Light beam: SPOT

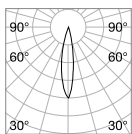

m	lx	Øm
1	1374	0,30
2	344	0,60
3	153	0,91
4	86	1,20
5	55	1,50



CRI≥90 3W 20° 210lm 3000K



244808



244822



244846



244853



Quark

□ IP20 CRI ≥80 50.000 h ALLUMINIO

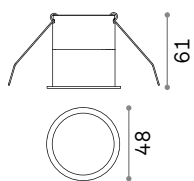

⌀ 45 mm

0,170 Kg/0,0005 m³

LED COB CITIZEN AND DRIVER Incluso

Potenza	Angolo	Lumen	CCT	Finitura	Codice	€
8W	30°	720 lm	3000 K	Bianco	258478	57
				Nero	258461	57



Light beam: ACCENT

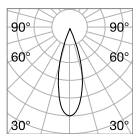

m	lx	Øm
1	1446	0,54
2	362	1,10
3	161	1,60
4	90	2,20
5	56	2,70



CRI ≥80 8W 30° 550lm 3000K

Off

Incasso fisso in alluminio pressofuso con ghiera rotonda in tre dimensioni, adatto per installazione su soffitti in cartongesso. Finitura nera opaca RAL 9005 e bianca opaca RAL 9016, LED integrati raffreddati passivamente; tecnologia COB (Chip on Board) per la massima efficienza; UGR < 19; binning iniziale ≤ 3-Step MacAdam; disponibile in temperatura di colore 3000 K e 4000 K; CRI ≥ 90; protezione frontale IP54 (a prodotto installato); classe isolamento II; in opzione dimmerabile 1-10V, DALI e Push; durata utile LED 50.000 h L80B50. Adatto per UFFICI e ambienti DIREZIONALI e in generale dove vi sia la presenza di videotermini e la necessità di garantire un controllo dell'abbagliamento elevato. L'elevata resa cromatica lo rende ideale anche per gli spazi espositivi e la valorizzazione della merce in showroom e aree vendita nel settore RETAIL.

PRO Prodotto ad alto contenuto tecnologico, elevata qualità dei materiali, destinato ad uso professionale.

UGR Articolo con UGR <19.

IP54 Grado di protezione IP54.

Sorgente	LED COB
Potenza	15W / 28W / 42W
Driver incluso	On/Off
Driver disponibili	1-10V / DALI / Push
MacAdam	SDCM 3
CCT	3000 K / 4000 K
CRI	≥90
UGR	<19
Durata LED	50.000 h
Classe isolamento	II
IP	54
Materiale	Alluminio
Garanzia	5 anni





Off

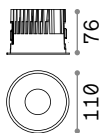

⌀ 100 mm

0,460 Kg/0,0021 m³

LED COB CITIZEN Driver TRIDONIC ON/OFF incluso

Potenza	Angolo	Lumen	CCT	Finitura	Codice	€
15 W	50°	1350 lm	3000 K	Bianco	266497	86
				Nero	266558	86
		1450 lm	4000 K	Bianco	266503	86
				Nero	266565	86

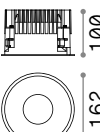

⌀ 150 mm

0,990 Kg/0,0045 m³

LED COB CITIZEN Driver TRIDONIC ON/OFF incluso

Potenza	Angolo	Lumen	CCT	Finitura	Codice	€
28 W	60°	2900 lm	3000 K	Bianco	266510	128
				Nero	266572	128
		3150 lm	4000 K	Bianco	266527	128
				Nero	266589	128



⌀ 195 mm

1,850 Kg/0,0094 m³

LED COB CITIZEN Driver TRIDONIC ON/OFF incluso

Potenza	Angolo	Lumen	CCT	Finitura	Codice	€
42 W	60°	4150 lm	3000 K	Bianco	266534	180
				Nero	266596	180
		4500 lm	4000 K	Bianco	266541	180
				Nero	266602	180



REFLECTOR

Modello	Necessario	Finitura	Codice	€
Off 15 W	No	Nero	266619	15
Off 28 W	No	Nero	266626	23
Off 42 W	No	Nero	266633	24

DIMMABLE DRIVER* Optional

Modello	Controllo	Potenza	Output	Misura (L x H x P)	Codice	€
Off 15 W	1-10V/Push	20 W	350 mA	105 x 20 x 50 mm	266657	70
	DALI	20 W	350 mA	105 x 20 x 50 mm	266701	70
Off 28 W	1-10V/Push	22 W	700 mA	100 x 20 x 65 mm	266671	95
	DALI	32 W	700 mA	100 x 20 x 65 mm	266725	95
Off 42 W	1-10V	42 W	1050 mA	120 x 20 x 75 mm	266688	115
	DALI/Push	45 W	1050 mA	150 x 30 x 43 mm	266732	110



Light beam: WIDE

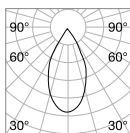

m	lx	Øm
1	1688	0,93
2	422	1,90
3	188	2,80
4	105	3,70
5	68	4,60

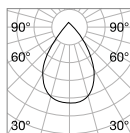
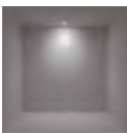

m	lx	Øm
1	2457	1,30
2	614	2,50
3	273	3,80
4	154	5,10
5	98	6,40

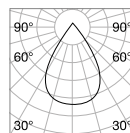
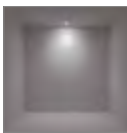

m	lx	Øm
1	3496	1,20
2	874	2,40
3	388	3,60
4	218	4,80
5	140	6,00



CRI≥90 15W 50° 1100lm 3000K

CRI≥90 28W 60° 2300lm 3000K

CRI≥90 42W 60° 4600lm 3000K

* Gli alimentatori dimmerabili devono essere ordinati contestualmente al prodotto e verranno già inclusi all'interno degli apparecchi in sostituzione degli alimentatori on-off.



Deep

Sorgente	LED SMD	Durata LED	50.000 h
Potenza	10W/20W/30W	Classe isolamento	II
Driver incluso	On/Off	IP	20
Driver disponibili	1-10V/DALI/ Push	Materiale	Alluminio
CCT	3000 K/4000 K	Garanzia	5 anni
CRI	≥80		

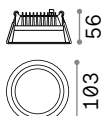

① 90 mm

0,160 Kg/0,0014 m³

LED SMD Driver ON/OFF incluso

Potenza	Angolo	Lumen	CCT	Finitura	Codice	€
10 W	70°	1350 lm	3000 K	Bianco	249018	28
		1450 lm	4000 K	Bianco	249025	28

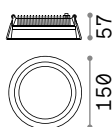

① 145 mm

0,360 Kg/0,0037 m³

LED SMD Driver ON/OFF incluso

Potenza	Angolo	Lumen	CCT	Finitura	Codice	€
20 W	77°	2750 lm	3000 K	Bianco	249032	62
		2950 lm	4000 K	Bianco	249049	62

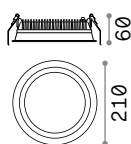

① 200 mm

0,650 Kg/0,0053 m³

LED SMD Driver ON/OFF incluso

Potenza	Angolo	Lumen	CCT	Finitura	Codice	€
30 W	77°	4150 lm	3000 K	Bianco	248783	84
		4350 lm	4000 K	Bianco	248790	84

DIMMABLE DRIVER* Optional

Modello	Controllo	Potenza	Output	Misura (LxHxP)	Codice	€
Deep 10 W	1-10V	10 W	300 mA	135 x 20 x 30 mm	248950	57
	DALI	12 W	300 mA	135 x 20 x 30 mm	248967	57
Deep 20 W	1-10V/Push	25 W	500 mA	167 x 32 x 41 mm	248974	98
	DALI/Push	25 W	500 mA	167 x 32 x 41 mm	248981	98
Deep 30 W	1-10V/Push	30 W	750 mA	167 x 32 x 41 mm	248998	105
	DALI/Push	36 W	700 mA	167 x 30 x 39 mm	249001	105



Light beam: WIDE

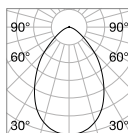

m	lx	cm
1	625	1,43
2	156	2,86
3	69	4,30
4	39	5,73
5	25	7,16

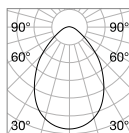
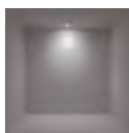

m	lx	cm
1	1056	1,60
2	264	3,20
3	117	4,81
4	66	6,41
5	42	8,01

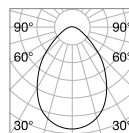
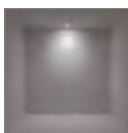

m	lx	cm
1	1644	1,60
2	411	3,20
3	183	4,81
4	103	6,41
5	66	8,01



CRI≥80 10W 70° 1200lm 3000K

CRI≥80 20W 77° 2100lm 3000K

CRI≥80 30W 77° 3200lm 3000K

* Gli alimentatori dimmerabili devono essere ordinati contestualmente al prodotto e verranno già inclusi all'interno degli apparecchi in sostituzione degli alimentatori on-off.



Basic

Faretto a incasso in alluminio pressofuso con ghiera rotonda, adatto per installazione su soffitti in cartongesso. Finitura bianca opaca; tecnologia COB Chip on Board e SMD. Disponibile in temperatura di colore 3000 K e 4000 K e con tre diverse ottiche; CRI ≥ 80 ; protezione frontale IP44 (a prodotto installato); classe isolamento II; durata utile LED 30.000 h L70B50.

IP44 Grado di protezione IP44.

Sorgente	LED COB / SMD
Potenza	10W / 15W / 20W / 30W
Driver incluso	On/Off
Driver disponibili	1-10V / DALI / Push
MacAdam	SDCM ≤ 3
CCT	3000 K / 4000 K
CRI	≥ 80
Durata LED	30.000 h
Classe isolamento	II
IP	44
Materiale	Alluminio
Garanzia	5 anni





Basic Accent

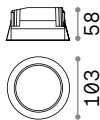

① 90 mm
0,400 Kg/0,0017 m³

LED COB PHILIPS Driver PHILIPS ON/OFF incluso

Potenza	Angolo	Lumen	CCT	Finitura	Codice	€
10 W	45°	1050 lm	3000 K	Bianco	193458	68
		1200 lm	4000 K	Bianco	193359	68

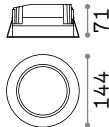

① 125 mm
0,660 Kg/0,0027 m³

LED COB PHILIPS Driver PHILIPS ON/OFF incluso

Potenza	Angolo	Lumen	CCT	Finitura	Codice	€
15 W	52°	1500 lm	3000 K	Bianco	193465	85
		1550 lm	4000 K	Bianco	193366	85
20 W		1950 lm	3000 K	Bianco	193472	90
		2050 lm	4000 K	Bianco	193373	90

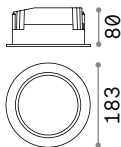

① 160 mm
1,250 Kg/0,0056 m³

LED COB PHILIPS Driver PHILIPS ON/OFF incluso

Potenza	Angolo	Lumen	CCT	Finitura	Codice	€
30 W	46°	2500 lm	3000 K	Bianco	193489	145
		2550 lm	4000 K	Bianco	193380	145

DIMMABLE DRIVER* Optional

Modello	Controllo	Potenza	Output	Misura (LxHxP)	Codice	€
Basic 10 W	1-10V	12 W	300 mA	150 x 29 x 43 mm	218823	40
	DALI/Push	10 W	300 mA	130 x 30 x 43 mm	220772	125
Basic 15 W	1-10V	15 W	450 mA	150 x 29 x 43 mm	218830	45
	DALI/Push	17 W	450 mA	130 x 30 x 43 mm	220796	134
Basic 20 W	DALI/Push	25 W	700 mA	130 x 30 x 43 mm	220789	146
Basic 30 W	1-10V	31 W	900 mA	150 x 29 x 43 mm	218854	50
	DALI/Push	45 W	900 mA	150 x 30 x 43 mm	220802	158



Light beam: **ACCENT**

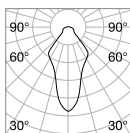

m	lx	øm
1	533	0,81
2	133	1,62
3	59	2,44
4	33	3,25
5	21	4,07

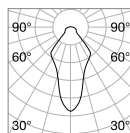

m	lx	øm
1	719	0,98
2	179	1,96
3	79	2,95
4	44	3,93
5	28	4,92

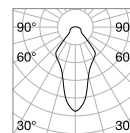

m	lx	øm
1	1250	0,92
2	312	1,84
3	138	2,76
4	78	3,69
5	50	4,61



CRI≥80 10W 45° 1000lm 3000K

CRI≥80 15W 52° 1550lm 3000K

CRI≥80 30W 46° 2900lm 3000K

* Gli alimentatori dimmerabili devono essere ordinati contestualmente al prodotto e verranno già inclusi all'interno degli apparecchi in sostituzione degli alimentatori on-off.



Basic Wide

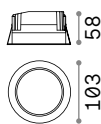

① 90 mm
0,370 Kg/0,0017 m³

LED SMD SAMSUNG Driver PHILIPS ON/OFF incluso

Potenza	Angolo	Lumen	CCT	Finitura	Codice	€
10 W	85°	1150 lm	3000 K	Bianco	193519	65
		1200 lm	4000 K	Bianco	193403	65

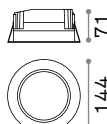

① 125 mm
0,630 Kg/0,0027 m³

LED SMD SAMSUNG Driver PHILIPS ON/OFF incluso

Potenza	Angolo	Lumen	CCT	Finitura	Codice	€
15 W	87°	1750 lm	3000 K	Bianco	193526	80
		1800 lm	4000 K	Bianco	193410	80
20 W		2400 lm	3000 K	Bianco	193533	85
		2500 lm	4000 K	Bianco	193427	85

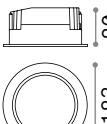

① 160 mm
1,130 Kg/0,0056 m³

LED SMD SAMSUNG Driver PHILIPS ON/OFF incluso

Potenza	Angolo	Lumen	CCT	Finitura	Codice	€
30 W	90°	3050 lm	3000 K	Bianco	193540	140
		3150 lm	4000 K	Bianco	193434	140

DIMMABLE DRIVER* Optional

Modello	Controllo	Potenza	Output	Misura (LxHxP)	Codice	€
Basic 10 W	1-10V	12 W	300 mA	150 x 29 x 43 mm	218823	40
	DALI/Push	10 W	300 mA	130 x 30 x 43 mm	220772	125
Basic 15 W	1-10V	15 W	450 mA	150 x 29 x 43 mm	218830	45
	DALI/Push	17 W	450 mA	130 x 30 x 43 mm	220796	134
Basic 20 W	DALI/Push	25 W	700 mA	130 x 30 x 43 mm	220789	146
Basic 30 W	1-10V	31 W	900 mA	150 x 29 x 43 mm	218854	50
	DALI/Push	45 W	900 mA	150 x 30 x 43 mm	220802	158



Light beam: **WIDE**

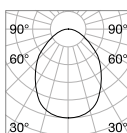

m	lx	øm
1	188	1,84
2	47	3,69
3	20	5,54
4	11	7,39
5	7	9,24

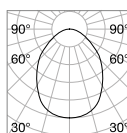
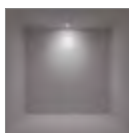

m	lx	øm
1	318	1,72
2	79	3,44
3	35	5,17
4	19	6,89
5	12	8,61

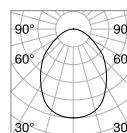

m	lx	øm
1	591	1,84
2	147	3,69
3	65	5,53
4	36	7,38
5	23	9,23



CRI≥80 10W 85° 1000lm 3000K

CRI≥80 15W 87° 1500lm 3000K

CRI≥80 30W 90° 2900lm 3000K

* Gli alimentatori dimmerabili devono essere ordinati contestualmente al prodotto e verranno già inclusi all'interno degli apparecchi in sostituzione degli alimentatori on-off.



Groove

IP20 CRI ≥80 30.000 h ALLUMINIO

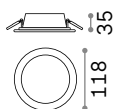

① 100 mm

0,220 Kg/0,0012 m³

LED SMD AND DRIVER Incluso

Potenza	Angolo	Lumen	CCT	Finitura	Codice	€
10 W	110°	1250 lm	3000 K	Bianco	123974	25
		1350 lm	4000 K	Bianco	147666	25

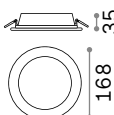

① 150 mm

0,410 Kg/0,0023 m³

LED SMD AND DRIVER Incluso

Potenza	Angolo	Lumen	CCT	Finitura	Codice	€
20 W	110°	2600 lm	3000 K	Bianco	123998	34
		2700 lm	4000 K	Bianco	147673	34

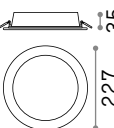

① 205 mm

0,660 Kg/0,0036 m³

LED SMD AND DRIVER Incluso

Potenza	Angolo	Lumen	CCT	Finitura	Codice	€
30 W	110°	3800 lm	3000 K	Bianco	124018	46
		4050 lm	4000 K	Bianco	147680	46

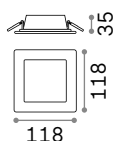

① 100 x 100 mm

0,270 Kg/0,0012 m³

LED SMD AND DRIVER Incluso

Potenza	Angolo	Lumen	CCT	Finitura	Codice	€
10 W	110°	1200 lm	3000 K	Bianco	123981	26

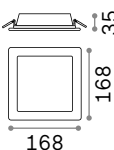

① 150 x 150 mm

0,540 Kg/0,0023 m³

LED SMD AND DRIVER Incluso

Potenza	Angolo	Lumen	CCT	Finitura	Codice	€
20 W	110°	2450 lm	3000 K	Bianco	124001	36

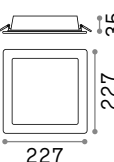

① 205 x 205 mm

0,850 Kg/0,0036 m³

LED SMD AND DRIVER Incluso

Potenza	Angolo	Lumen	CCT	Finitura	Codice	€
30 W	110°	3900 lm	3000 K	Bianco	124025	49



Light beam: WIDE



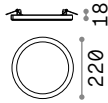

Ⓢ min 65-max 205 mm
0,350 Kg/0,0018 m³

LED SMD AND DRIVER Incluso

Potenza	Angolo	Lumen	CCT	Finitura	Codice	€
20 W	115°	1950 lm	3000 K	Bianco	290799	50 <small>new</small>
				Nero	290775	50 <small>new</small>
		2000 lm	4000 K	Bianco	306346	50 <small>new</small>
				Nero	306360	50 <small>new</small>

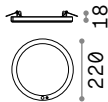

Ⓢ min 65-max 205 mm
0,350 Kg/0,0018 m³

LED SMD AND DRIVER Incluso - Rilevazione di presenza PIR e sensore crepuscolare inclusi.



Potenza	Angolo	Lumen	CCT	Finitura	Codice	€
20 W	115°	1950 lm	3000 K	Bianco	290805	60 <small>new</small>
				Nero	290782	60 <small>new</small>
		2000 lm	4000 K	Bianco	306353	60 <small>new</small>
				Nero	306377	60 <small>new</small>

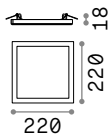

Ⓢ min 65-max 205 mm
0,400 Kg/0,0018 m³

LED SMD AND DRIVER Incluso

Potenza	Angolo	Lumen	CCT	Finitura	Codice	€
20 W	115°	1950 lm	3000 K	Bianco	290836	58 <small>new</small>
				Nero	290812	58 <small>new</small>
		2000 lm	4000 K	Bianco	306384	58 <small>new</small>
				Nero	306407	58 <small>new</small>

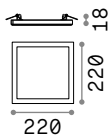

Ⓢ min 65-max 205 mm
0,400 Kg/0,0018 m³

LED SMD AND DRIVER Incluso - Rilevazione di presenza PIR e sensore crepuscolare inclusi.



Potenza	Angolo	Lumen	CCT	Finitura	Codice	€
20 W	115°	1950 lm	3000 K	Bianco	290843	66 <small>new</small>
				Nero	290829	66 <small>new</small>
		2000 lm	4000 K	Bianco	306391	66 <small>new</small>
				Nero	306414	66 <small>new</small>



Light beam: **WIDE**









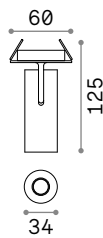

Play

☐ IP20 CRI ≥ 90 30.000 h ALLUMINIO



LED COB AND DRIVER Incluso

Potenza	Angolo	Lumen	CCT	Finitura	Codice	€
7 W	17°	520 lm	3000 K	Bianco	258270	70
				Nero	268088	70

 90°
  355°
  45 mm
 0,220 Kg/0,0014 m³



Light beam: SPOT



P. 307



Channel

□ IP20 ALLUMINIO

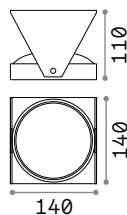

GU10 Lampadine LED GU10 10W 3000 K incluse. Cod. **189031**

Potenza	Finitura	Codice	€
max 13W	Nero	■ 203140	85

0,490 Kg/0,0037 m³

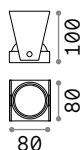

GU10 Lampadine LED GU10 7W 3000 K incluse. Cod. **123943**

Potenza	Finitura	Codice	€
max 7W	Nero	■ 203133	52

0,170 Kg/0,0017 m³

Nova

Sorgente	LED COB	Durata LED	50.000 h
Potenza	12W / 30W	Classe isolamento	II
Driver incluso	On/Off	IP	20
Driver disponibili	1-10V / DALI / Push	Materiale	Alluminio
CCT	3000 K / 4000 K	Garanzia	5 anni
CRI	≥90		

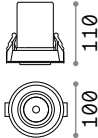

90° 360° 90 mm
 0,550 Kg/0,0016 m³

LED COB PHILIPS Driver ON/OFF incluso - UGR <19

Potenza	Angolo	Lumen	CCT	Finitura	Codice	€
12 W	38°	1000 lm	3000 K	Bianco	248165	75
				Nero	248189	75
		1100 lm	4000 K	Bianco	267937	75
				Nero	267920	75

DIMMABLE DRIVER* Optional

	Potenza	Output	Misura (LxHxP)	Codice	€
1-10V / Push	15 W	300 mA	167 x 31 x 41 mm	243993	60
DALI	12 W	300 mA	135 x 20 x 30 mm	243986	50

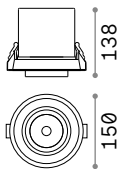

90° 360° 140 mm
 1,160 Kg/0,0039 m³

LED COB PHILIPS Driver ON/OFF incluso - UGR <22

Potenza	Angolo	Lumen	CCT	Finitura	Codice	€
30 W	38°	3000 lm	3000 K	Bianco	248172	125
				Nero	248196	125
		3250 lm	4000 K	Bianco	267951	125
				Nero	267944	125

DIMMABLE DRIVER* Optional

	Potenza	Output	Misura (LxHxP)	Codice	€
1-10V / Push	36 W	750 mA	167 x 32 x 41 mm	248370	90
DALI / Push	36 W	700 mA	167 x 30 x 39 mm	248592	105



LENS

Modello	Necessario	Angolo	Codice	€
Nova 12W	No	15°	244013	6
Nova 30W	No	15°	248608	12



Light beam: ACCENT

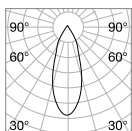

m	lx	cm
1	1768	0,66
2	442	1,32
3	196	1,97
4	111	2,63
5	71	3,29



CRI≥90 12W 38° 1000lm 3000K

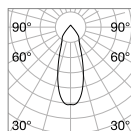

m	lx	cm
1	4671	0,64
2	1168	1,28
3	519	1,93
4	292	2,57
5	187	3,21



CRI≥90 30W 38° 3150lm 3000K

* Gli alimentatori dimmerabili devono essere ordinati contestualmente al prodotto e verranno già inclusi all'interno degli apparecchi in sostituzione degli alimentatori on-off.

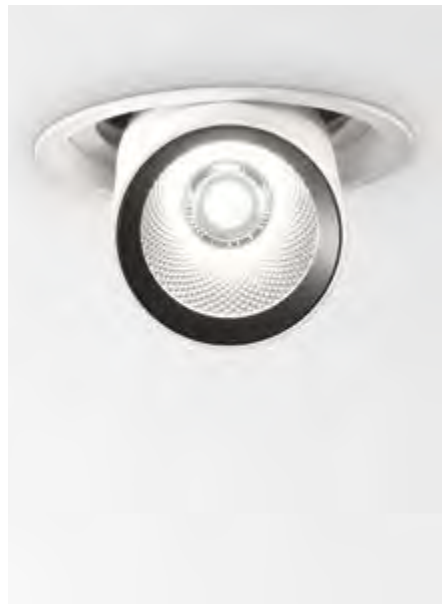

Led Panel

Sorgente	LED SMD	UGR	<19
Potenza	40W	Durata LED	25.000 h
Driver incluso	On/Off	Classe isolamento	II
Driver disponibili	1-10V / DALI / Push	IP	20
CCT	3000 K / 4000 K	Materiale	Alluminio
CRI	≥80 / ≥90	Garanzia	5 anni



2,200 Kg/0,0144 m³
Q.tà d'acquisto 2 pezzi

LED SMD Driver ON/OFF incluso

CRI ≥80

Potenza	Angolo	Lumen	CCT	Finitura	Codice	€
40 W	81°	4150 lm	3000 K	Bianco	249711	45
		4450 lm	4000 K	Bianco	249728	45

CRI ≥90

Potenza	Angolo	Lumen	CCT	Finitura	Codice	€
40 W	81°	3550 lm	3000 K	Bianco	246390	45
		3800 lm	4000 K	Bianco	244181	45

DIMMABLE DRIVER* Optional

	Potenza	Output	Misura (L x H x P)	Codice	€
1-10V	42 W	1000 mA	125 x 26 x 83 mm	247854	37
DALI/Push	45 W	1000 mA	106 x 28 x 69 mm	247847	67



KIT PENDANT

KIT SURFACE

RECESSED FRAME**

Necessario	N° Cavi	Lunghezza cavi	Codice	€
No	4	1000 mm	244198	6
No			244204	6
No			267692	17



Light beam: WIDE

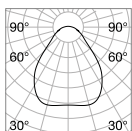

m	lx	Øm
1	1470	1,79
2	367	3,59
3	163	5,38
4	92	7,18
5	59	8,97

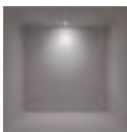

CRI≥80 38,5W 81° 3800lm 3000K

* Gli alimentatori dimmerabili devono essere ordinati contestualmente al prodotto e verranno già inclusi all'interno degli apparecchi in sostituzione degli alimentatori on-off.

**RECESSED FRAME □ 607 x 607 mm



Lika

Famiglia di moduli a incasso LED rettangolari in alluminio pressofuso verniciato nero o bianco, con riflettore in policarbonato nero lucido. Disponibili nelle versioni TRIM con cornice e TRIMLESS con bordo arretrato a scomparsa totale per installazione su soffitti in cartongesso. Moduli disponibili con due, cinque oppure dieci sorgenti luminose. Appositamente disegnato per evitare abbagliamenti ($UGR < 16$), trova la sua migliore collocazione all'interno di UFFICI e spazi COMMERCIALI oppure in ambienti residenziali minimalisti. Sorgente luminosa a LED integrati; disponibile in temperatura di colore 3000 K e 4000 K; $CRI \geq 90$; protezione IP20, classe isolamento II; durata utile LED 50.000 h L70B50.

UGR Articolo con $UGR < 16$.

Sorgente	LED COB
Potenza	6W / 12W / 20W
Driver incluso	On/Off
Driver disponibili	DALI / Push
CCT	3000 K / 4000 K
CRI	≥ 90
UGR	< 16
Durata LED	50.000 h
Classe isolamento	II
IP	20
Materiale	Alluminio
Garanzia	5 anni





Lika Trim

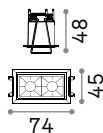

68 x 37 mm
0,130 Kg/0,0005 m³

LED COB OSRAM Driver ON/OFF incluso

Potenza	Angolo	Lumen	CCT	Finitura	Codice	€
6 W	29°	480 lm	3000 K	Nero	+ 206196	45
		520 lm	4000 K	Nero	+ 267869	45

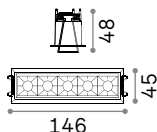

140 x 37 mm
0,240 Kg/0,0008 m³

LED COB OSRAM Driver ON/OFF incluso

Potenza	Angolo	Lumen	CCT	Finitura	Codice	€
12 W	29°	1200 lm	3000 K	Nero	+ 206219	65
		1250 lm	4000 K	Nero	+ 267876	65

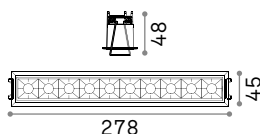

273 x 37 mm
0,480 Kg/0,0016 m³

LED COB OSRAM Driver ON/OFF incluso

Potenza	Angolo	Lumen	CCT	Finitura	Codice	€
20 W	29°	1750 lm	3000 K	Nero	+ 206233	110
		1850 lm	4000 K	Nero	+ 267883	110

DIMMABLE DRIVER* Optional

Modello	Controllo	Potenza	Output	Misura (LxHxP)	Codice	€
Lika 6 W	DALI	10 W	700 mA	135 x 20 x 30 mm	267982	56
Lika 12 W	DALI	12 W	700 mA	135 x 20 x 30 mm	267999	56
Lika 20 W	DALI/Push	25 W	600 mA	167 x 32 x 41 mm	268002	104



Light beam: ACCENT

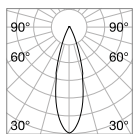

m	lx	Øm
1	2091	0,58
2	523	1,16
3	232	1,74
4	131	2,32
5	70	2,90



CRI≥90 12,5W 29° 1100lm 3000K

* Gli alimentatori dimmerabili devono essere ordinati contestualmente al prodotto e verranno già inclusi all'interno degli apparecchi in sostituzione degli alimentatori on-off.



Lika Trimless

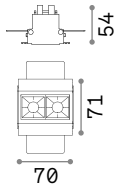

75 x 70 mm
0,220 Kg/0,0006 m³

LED COB OSRAM Driver ON/OFF incluso

Potenza	Angolo	Lumen	CCT	Finitura	Codice	€
6 W	29°	480 lm	3000 K	Nero	206202	60
		520 lm	4000 K	Nero	267890	60

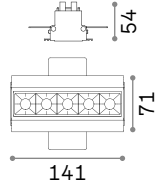

145 x 70 mm
0,390 Kg/0,0013 m³

LED COB OSRAM Driver ON/OFF incluso

Potenza	Angolo	Lumen	CCT	Finitura	Codice	€
12 W	29°	1200 lm	3000 K	Nero	206226	95
		1250 lm	4000 K	Nero	267906	95

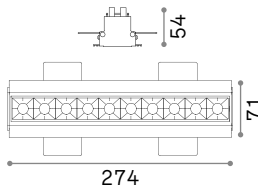

278 x 70 mm
0,720 Kg/0,0023 m³

LED COB OSRAM Driver ON/OFF incluso

Potenza	Angolo	Lumen	CCT	Finitura	Codice	€
20 W	29°	1750 lm	3000 K	Nero	206240	151
		1850 lm	4000 K	Nero	267913	151

DIMMABLE DRIVER* Optional

Modello	Controllo	Potenza	Output	Misura (L x H x P)	Codice	€
Lika 6 W	DALI	10 W	700 mA	135 x 20 x 30 mm	267982	56
Lika 12 W	DALI	12 W	700 mA	135 x 20 x 30 mm	267999	56
Lika 20 W	DALI/Push	25 W	600 mA	167 x 32 x 41 mm	268002	104



Light beam: ACCENT

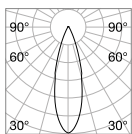

m	Ix	Øm
1	2786	0,58
2	696	1,16
3	309	1,74
4	174	2,32
5	111	2,90



CRI≥90 12,5W 29° 1100lm 3000K

* Gli alimentatori dimmerabili devono essere ordinati contestualmente al prodotto e verranno già inclusi all'interno degli apparecchi in sostituzione degli alimentatori on-off.



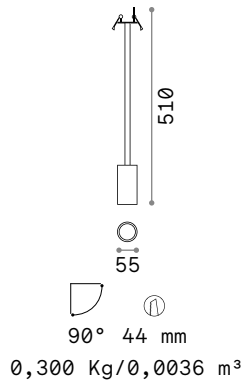

GU10 Lampadine LED GU10 7W 3000 K incluse. Cod. 123943

Potenza	Finitura	Codice	€
max 28W	Bianco	296401	36 <small>new</small>
	Nero	296395	36 <small>new</small>

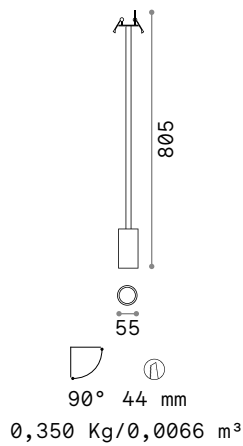

GU10 Lampadine LED GU10 7W 3000 K incluse. Cod. 123943

Potenza	Finitura	Codice	€
max 28W	Bianco	296388	41 <small>new</small>
	Nero	296371	41 <small>new</small>



Light beam: SPOT

Eye

IP20 CRI ≥ 80 30.000 h ALLUMINIO

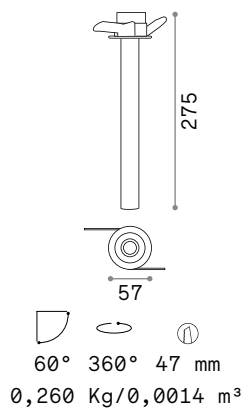

LED COB AND DRIVER Incluso

Potenza	Angolo	Lumen	CCT	Finitura	Codice	€
2,5W	15°	270 lm	3000 K	Bianco	186986	85



Light beam: SPOT



Zephyr

IP20 GESSO

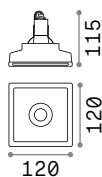

123 x 123 mm
0,880 Kg/0,0032 m³

GU10 Non inclusa - Lampadina consigliata 108292

Potenza	Finitura	Codice	€
max 35W	Bianco	150284	19

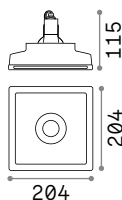

20° 110° 207 x 207 mm
1,350 Kg/0,0075 m³

GU10 Non inclusa - Lampadina consigliata 108292

Potenza	Finitura	Codice	€
max 35W	Bianco	155722	61

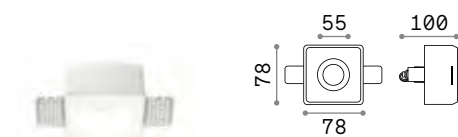

83 x 83 mm



103 mm



133 mm



123 mm

GU10 Non inclusa - Lampadina consigliata 108292

Potenza	Peso	Volume	Finitura	Codice	€
max 35W	0,360 Kg	0,0016 m ³	Bianco	230580	15

Potenza	Peso	Volume	Finitura	Codice	€
max 35W	0,230 Kg	0,0018 m ³	Bianco	150307	15

Potenza	Peso	Volume	Finitura	Codice	€
max 35W	0,450 Kg	0,0032 m ³	Bianco	150130	15

Potenza	Peso	Volume	Finitura	Codice	€
max 50W	0,340 Kg	0,0022 m ³	Bianco	139012	15



83 x 83 mm



103 x 103 mm



123 x 123 mm



124 x 124 mm

GU10 Non inclusa - Lampadina consigliata 108292

Potenza	Peso	Volume	Finitura	Codice	€
max 35W	0,330 Kg	0,0016 m ³	Bianco	229997	15

Potenza	Peso	Volume	Finitura	Codice	€
max 35W	0,320 Kg	0,0018 m ³	Bianco	150291	15

Potenza	Peso	Volume	Finitura	Codice	€
max 35W	0,600 Kg	0,0037 m ³	Bianco	150116	15

Diffusore in vetro

Potenza	Peso	Volume	Finitura	Codice	€
max 50W	0,430 Kg	0,0023 m ³	Bianco	139029	15



Jazz

IP20 ZINCO

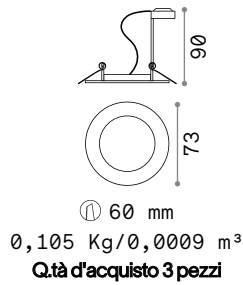

GU10 Non inclusa - Lampadina consigliata 108292

Potenza	Finitura	Codice	€
max 50W	Bianco	083117	10
	Brunito	083124	10
	Cromo	083070	10
	Nero	243818	10
	Nickel	083087	10

Swing

IP20 ZINCO

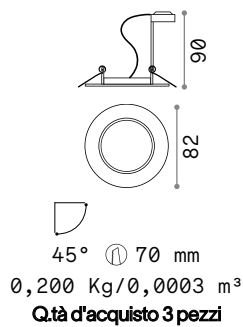

GU10 Non inclusa - Lampadina consigliata 108292

Potenza	Finitura	Codice	€
max 50W	Bianco	083179	12
	Brunito	083186	12
	Cromo	083131	12
	Nero	243825	12
	Nickel	083148	12

Lounge

IP20 ZINCO

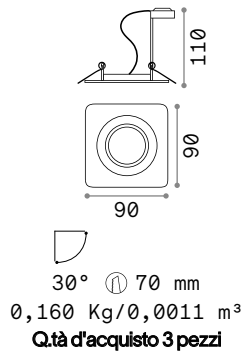

GU10 Non inclusa - Lampadina consigliata 108292

Potenza	Finitura	Codice	€
max 50W	Bianco	138978	17

Funky

IP20 FERRO

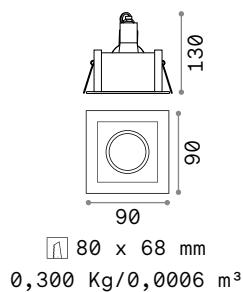

GU10 Non inclusa - Lampadina consigliata 108292

Potenza	Finitura	Codice	€
max 50W	Alluminio	083223	18
	Bianco	083230	18
	Brunito	083247	18
	Cromo	083193	18
	Nero	243849	18



Room-65

☐ IP65 CRI ≥80 50.000 h ALLUMINIO

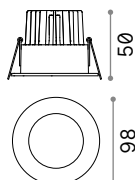

① 68 mm

0,220 Kg/0,0011 m³

LED COB Driver ON/OFF incluso

Potenza	Angolo	Lumen	CCT	Finitura	Codice	€
8 W	38°	800 lm	3000 K	Bianco	252025	77
				Nero	252032	77

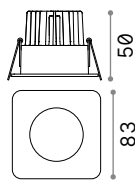

① 68 mm

0,240 Kg/0,0011 m³

LED COB Driver ON/OFF incluso

Potenza	Angolo	Lumen	CCT	Finitura	Codice	€
8 W	38°	800 lm	3000 K	Bianco	252049	77
				Nero	252056	77



Light beam: ACCENT



Blues

 IP20 VETRO

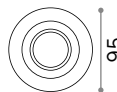
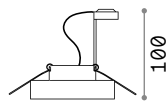

① 60 mm

0,330 Kg/0,0012 m³

Q.tà d'acquisto 3 pezzi

GU10 Non inclusa - Lampadina consigliata 108292

Potenza	Finitura	Codice	€
max 50W	Trasparente	083254	24
	Bianco	113999	24
	Fumè	113982	24

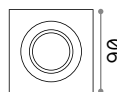
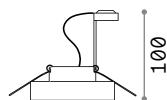

① 60 mm

0,340 Kg/0,0012 m³



Q.tà d'acquisto 3 pezzi

GU10 Non inclusa - Lampadina consigliata 108292

Potenza	Finitura	Codice	€
max 50W	Trasparente	114019	24



Soul

  IP20 CRISTALLO

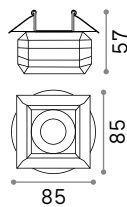

① 55 mm

0,340 Kg/0,0009 m³

G9 Non inclusa - Lampadina consigliata 209043

Potenza	Finitura	Codice	€
max 40W	Trasparente	107691	20

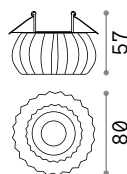

① 55 mm

0,400 Kg/0,0008 m³

G9 Non inclusa - Lampadina consigliata 209043

Potenza	Finitura	Codice	€
max 40W	Trasparente	107707	20



Polka

□ △ IP20

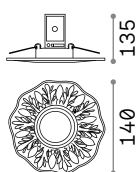

① 65 mm

0,200 Kg/0,0025 m³

GU10 Non inclusa - Lampadina consigliata 108292

Potenza	Materiale	Finitura	Codice	€
max 50W	Gesso	Bianco	115597	16
	Alluminio	Ottone	115610	16
	Alluminio	Brunito	115580	16



115597



115610



115580



Walky

□ IP20
 ☑ CRI ≥ 90
 50.000 h GESSO

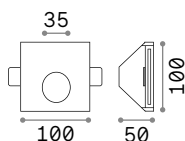

□ 100 x 100mm

0,580 Kg/0,0009 m³

LED SMD AND DRIVER Incluso

Potenza	Lumen	CCT	Finitura	Codice	€
1W	55 lm	3000 K	Bianco	249834	63

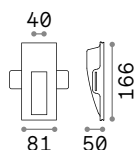

□ 81 x 166 mm

0,580 Kg/0,0012 m³

LED SMD AND DRIVER Incluso

Potenza	Lumen	CCT	Finitura	Codice	€
1W	55 lm	3000 K	Bianco	249827	63



Light beam: **ASYMMETRICAL**



Esterni

Sospensioni e soffitto

Indice alfabetico

Bubble	730
Clio	724
Fiesta	731
Gun	727
Luna	723
Mib	730
Sole	722
Sunglasses	728
Techo	726
Urano	729
Xeno	728

Indice icone



Sole 722



Luna 723



Clio 724



Clio 724



Clio 724



Clio 724



Clio 724



Clio 724



Techo 726



Gun 727



Sunglasses 728



Xeno 728



Urano 729



Bubble 730



Mib 730



Fiesta 731



Sole

Diffusore in materiale plastico opale. Base sospensione in alluminio. Cavo elettrico in PVC.

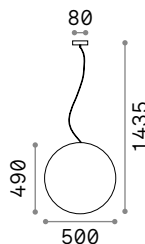

IP44

2,970 Kg / 0,1327 m³
E27 max 1x60W

€ 225

136011 Bianco

4000 K
1000 lm

151991 € 2,50

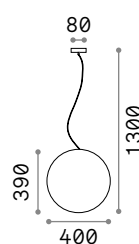

IP44

1,690 Kg / 0,0776 m³
E27 max 1x60W

€ 145

136004 Bianco

4000 K
1000 lm

151991 € 2,50

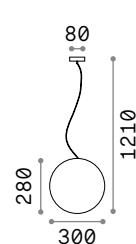

IP44

1,360 Kg / 0,0338 m³
E27 max 1x60W

€ 110

135991 Bianco

4000 K
1000 lm

151991 € 2,50



P.783



Luna

Montatura in alluminio pressofuso e tornito rifinito con vernici a polveri. Diffusore in materiale plastico opale.

LED Lampadine LED G9 3W 4000 K incluse nel modello **213200**. Cod. **209036**

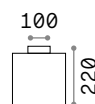

1,470 Kg / 0,0120 m³
E27 max 1x42W

€ 132

213194 Bianco



0,400 Kg / 0,0021 m³
G9 max 1x5W

€ 115

213200 Bianco

 **4000 K**
1000 lm

151991 € 2,50

 **4000 K**
390 lm

209036 € 3,90



P. 784

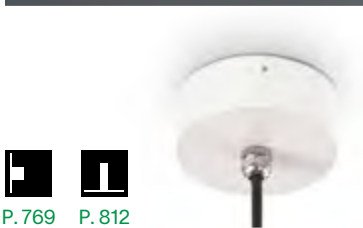

P. 769 P. 812

Clio

Articolo componibile con montatura in alluminio estruso e tornito, rifinito con vernici a polveri di colore antracite, bianco, grigio e nero. Diffusore in materiale plastico bianco opaco.

116716



145068



145020



144252



144238



136073



144245

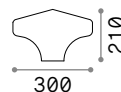
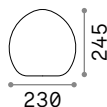
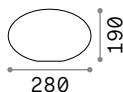
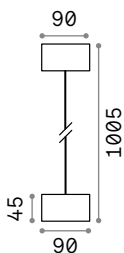

IP44

IP44

0,200 Kg / 0,0014 m³
E27 max 1x42W

0,580 Kg / 0,0019 m³
E27 max 1x42W

0,540 Kg / 0,0171 m³

0,520 Kg / 0,0144 m³

0,610 Kg / 0,0231 m³

€ 56

€ 73

€ 35

€ 35

€ 35

148847 Bianco
148854 Grigio
148861 Antracite
148878 Nero

144252 Bianco
144238 Grigio
136073 Antracite
144245 Nero

145068 Bianco

116716 Bianco

145020 Bianco

4000 K
600 lm

4000 K
600 lm

151960 € 2,50

151960 € 2,50



Techo

Corpo luce in alluminio pressofuso verniciato a polveri. Diffusore in vetro temperato trasparente smerigliato. Disponibile nelle finiture antracite, bianco, coffee o nero.



1,700 Kg / 0,0049 m³
GU10 max 1x20W

€ 115

251523 ■ Bianco
251516 ■ Antracite
251530 ■ Nero
251547 ■ Coffee

4000 K
820 lm

253398 € 15,00



0,600 Kg / 0,0012 m³
GU10 max 1x20W

€ 64

251561 ■ Bianco
251554 ■ Antracite
251578 ■ Nero
251592 ■ Coffee

4000 K
500 lm

253497 € 4,50



Gun

Corpo luce in alluminio con finitura naturale spazzolata o in vernice con varie finiture. Diffusore in vetro pirex trasparente.



122663 092324 163642 236865 122687 163666



0,490 Kg / 0,0030 m³
GU10 max 1x28W

€ 54

- 122663 Bianco
- 092324 Alluminio
- 163642 Grigio
- 236865 Antracite
- 122687 Nero
- 163666 Coffee

4000 K
500 lm

253497 € 4,50



P. 752

Sunglasses

Corpo luce in alluminio verniciato a polveri di colore antracite o bianco. Diffusori inclinabili con schermi in vetro trasparente.

LED Sorgente luminosa LED 4000 K, 30.000 h di durata.

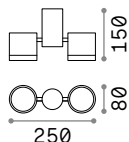

■ □ IP44

1,040 Kg / 0,0040 m³
LED 14,5W / 1450 lm

€ 125

161853 ■ Bianco
161846 ■ Antracite

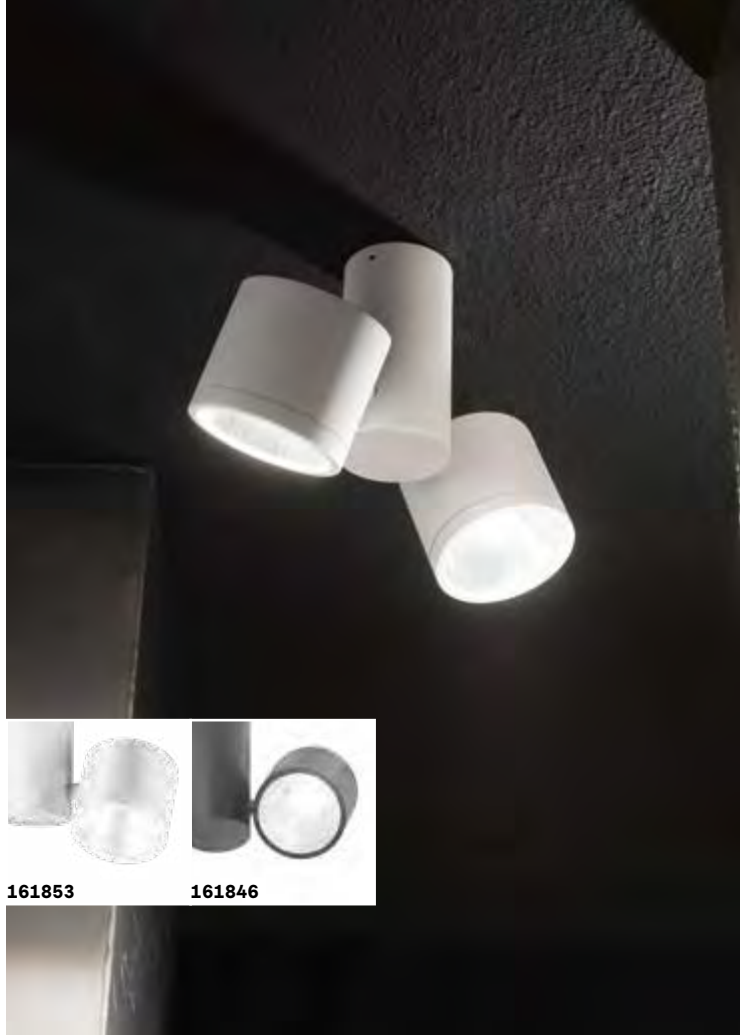

161853

161846

Xeno

Corpo luce in alluminio rifinito con vernice opaca a polveri. Diffusori orientabili con vetro temperato trasparente. Disponibile nelle finiture bianco, grigio o nero.

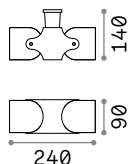

■ □ IP44

0,830 Kg / 0,0044 m³
GU10 max 2 x 28W

€ 72

129495 ■ Bianco
129518 ■ Grigio
129501 ■ Nero

4000 K
500 lm



253497 € 4,50 P. 741



129495

129518

129501



Urano

Corpo luce in alluminio tornito verniciato a polveri con finitura opaca antracite o bianca. Diffusore in materiale acrilico trasparente e satinato.



168050



168135

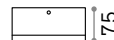

1,200 Kg / 0,0029 m³
GX53 max 1x15W

€ 92

168050 ■ Bianco
168135 ■ Antracite

4000 K
1000 lm

154008 € 6,00

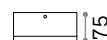

0,630 Kg / 0,0016 m³
GX53 max 1x15W

€ 66

168036 ■ Bianco
168111 ■ Antracite

4000 K
1000 lm

154008 € 6,00

Bubble

Montatura in alluminio pressofuso e tornito rifinito con vernici a polveri. Diffusore in materiale plastico bianco opaco.

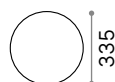

1,730 Kg / 0,0249 m³

E27 max 1x 60W

€ 125

135250 Bianco

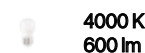

151960

€ 2,50

P. 768



Mib

Base in alluminio verniciato a polveri di colore bianco. Diffusore in materiale plastico opale. Sorgente luminosa a led integrati.

LED Sorgente luminosa LED 3000/4000 K, 35.000 h di durata.

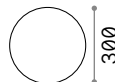

1,620 Kg / 0,0086 m³

LED 19W / 2000/2100 lm

€ 195

269115 Bianco

3000K

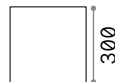

1,820 Kg / 0,0086 m³

LED 19W / 2100/2200 lm

€ 195

269122 Bianco

3000K

202945 Bianco

4000K





Fiesta

Cavo con portalampane e occhielli di ancoraggio in materiale plastico bianco o nero. Fornito con spina per esterni.

159836

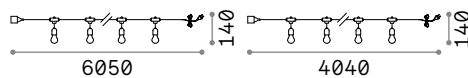

IP44

IP44

1,530 Kg / 0,0068 m³
E27 max 10 x 15W

0,600 Kg / 0,0049 m³
E27 max 5 x 15W

€ 110

€ 70

246802 ■ Bianco
246796 ■ Nero

218724 ■ Bianco
159836 ■ Nero

3000 K
340 lm
101286 € 3,00

3000 K
340 lm
101286 € 3,00



218724



Esterni

Lampade da parete

Indice alfabetico

Andromeda	761	Style	744
Apollo	751	Swipe	743
Argo	759	Terra	740
Base	754	Tetris-1	758
Bubble	768	Tetris-2	759
Cima	770	Tronco	746
Clio	769	Twin	760
Cometa	766	Up	756
Dafne	771	Xeno	741
Down	772		
Elio	738		
Etere	747		
Febe	773		
Felix	763		
Flood	742		
Gas	740		
Giove	762		
Gun	752		
Iko	755		
Keope	750		
Litio	739		
Medea	767		
Omega Round	736		
Omega Square	737		
Polar	767		
Rex-1	764		
Rex-2	765		
Rex-3	765		
Rubik	757		
Snif Round	748		
Snif Square	749		











































Down

Pag 772



Esterni

Indice icone

						
Omega R. 736	Omega S. 727	Elio 738	Litio 739	Terra 740	Gas 740	Xeno 741
						
Flood 742	Swipe 743	Style 744	Tronco 746	Etere 747	Snif Round 748	Snif Square 749
						
Keope 750	Apollo 751	Gun 752	Base 754	Iko 755	Up 756	Rubik 757
						
Tetris-1 758	Tetris-2 759	Argo 759	Twin 760	Andromeda 761	Giove 762	Felix 763
						
Rex-1 764	Rex-2 765	Rex-3 765	Cometa 766	Polar 767	Medea 767	Bubble 768
						
Clio 769	Clio 769	Clio 769	Cima 770	Dafne 771	Down 772	Febe 773



Omega Round

Corpo luce in alluminio verniciato a polveri. Diffusore inclinabile con schermo in vetro. Disponibile nelle finiture antracite, bianco, coffee o nero.

LED Sorgente luminosa LED 3000/4000 K, 25.000 h di durata.



285474



285450



285504



285498

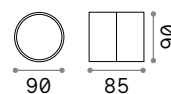

0,500 Kg / 0,0012 m³
LED 7W / 610/650 lm

€ 87

285474	Bianco	3000K
285481	Bianco	4000K
285450	Antracite	3000K
285467	Antracite	4000K
285504	Nero	4000K
285498	Coffee	4000K



Omega Square

Corpo luce in alluminio verniciato a polveri. Diffusore inclinabile con schermo in vetro. Disponibile nelle finiture antracite, bianco o nero.

LED Sorgente luminosa LED 4000 K, 25.000 h di durata.



285528



285511



285535

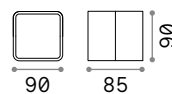

0,600 Kg / 0,0012 m³
LED 7W / 650 lm

€ 87

285528 ■ Bianco
285511 ■ Antracite
285535 ■ Nero



Elio

Corpo luce e diffusore in resina ad alte prestazioni: inattaccabile dalla corrosione sia di agenti atmosferici che di fertilizzanti chimici, colori stabilizzati da trattamento U.V., resistente a sbalzi termici da -60° C a + 90° C. Diffusore direzionabile.

LED Lampadine LED GU10 3,5W incluse.
CCT regolabile: 2700 K, 4000 K.



096483

096476

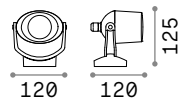

0,500 Kg / 0,0027 m³
GU10 max 1x6W

€ 82

096483 ■ Bianco
096476 ■ Nero

4000 K
500 lm
253497 € 4,50



P. 824



Litio

Corpo luce e diffusore in resina ad alte prestazioni: inattaccabile dalla corrosione sia di agenti atmosferici che di fertilizzanti chimici, colori stabilizzati da trattamento U.V., resistente a sbalzi termici da -60°C a $+90^{\circ}\text{C}$. Diffusore direzionabile.

LED Lampadine LED GX53 7W incluse.
CCT regolabile: 3000 K, 4000 K, 6500 K.



145303

145327

145341

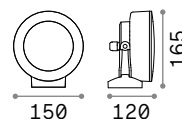

IP66

0,690 Kg / 0,0044 m³
GX53 max 1x10W

€ 90

145303 ■ Bianco
145327 ■ Grigio
145341 ■ Nero

4000 K
1000 lm

154008 € 6,00



P. 825

Terra

Montatura in fusione d'alluminio verniciata. Corpo luce posizionabile. Diffusore in vetro pirex trasparente.

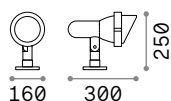

160

300

250

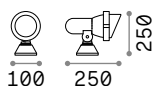

100

250

250

■ IP65

■ IP65

1,140 Kg / 0,0091 m³

E27 max 1x42W

0,530 Kg / 0,0024 m³

GU10 max 1x28W

€ 85

€ 45

046167 ■ Antracite

046181 ■ Antracite



4000 K
600 lm

151960

€ 2,50



4000 K
500 lm

253497

€ 4,50



P. 826

Gas

Corpo luce in alluminio pressofuso verniciato a polveri. Diffusore in vetro temperato trasparente sabbiato. Disponibile nelle finiture antracite, bianco, coffee o nero.

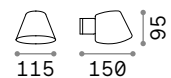

115

150

85

■ IP43

0,320 Kg / 0,0020 m³

GU10 max 1x28W

€ 50

091518 ■ Bianco

091525 ■ Antracite

020228 ■ Nero

213095 ■ Coffee



4000 K
500 lm

253497

€ 4,50



P. 796



091518

091525

020228

213095



Xeno

Corpo luce in alluminio rifinito con vernice opaca a polveri. Diffusori orientabili con vetro temperato trasparente. Disponibile nelle finiture bianco, grigio o nero.

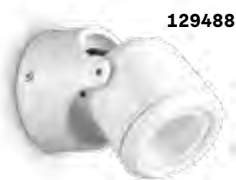

129488



129464

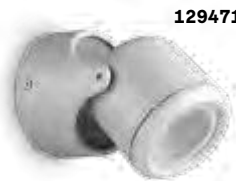

129471

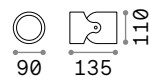

■ IP44

0,360 Kg / 0,0014 m³
GU10 max 1x28W

€ 35

129488 Bianco
129471 Grigio
129464 Nero

4000 K
500 lm

253497 € 4,50



P. 728



Flood

Corpo luce orientabile in alluminio pressofuso verniciato a polveri. Diffusore in vetro temperato trasparente e zigrinato. Modello con sensore di movimento con regolazione di lux e tempo di accensione. Disponibile nei colori bianco o nero.

LED Sorgente luminosa LED 4000 K, 25.000 h di durata.

 Lampada con rilevazione di presenza inclusa PIR (Passive InfraRed).

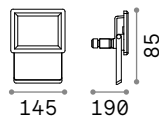

■  IP65

0,420 Kg / 0,0029 m³
LED 30W / 2450 lm

€ 32

269078 ■ Bianco
269061 ■ Nero

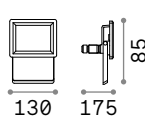

■  IP65

0,320 Kg / 0,0016 m³
LED 20W / 1750 lm

€ 22

251004 ■ Bianco
250991 ■ Nero

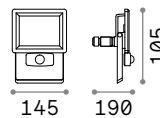

■  IP65 

0,440 Kg / 0,0029 m³
LED 30W / 2450 lm

€ 46

251028 ■ Bianco
251011 ■ Nero

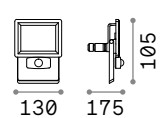

■  IP65 

0,360 Kg / 0,0027 m³
LED 20W / 1750 lm

€ 37

269108 ■ Bianco
269092 ■ Nero



Swipe ^{new}

Corpo luce in alluminio verniciato a polveri. Diffusore orientabile con schermo in policarbonato opale lucido. Disponibile con sensore crepuscolare e di movimento. Finiture: antracite, bianco, coffee oppure nero.

LED Sorgente luminosa LED 3000 K, 50.000 h di durata.

 Lampada con rilevazione di presenza inclusa PIR (Passive InfraRed).

287720



287713



287737



307176

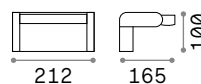

212

165

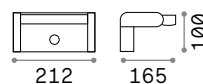

212

165



IP54



IP54

1,200 Kg / 0,0055 m³
LED 20,5W / 2300 lm

€ 115

1,300 Kg / 0,0055 m³
LED 21W / 2300 lm

€ 130

287690	Bianco	new	287720	Bianco	new
287683	Antracite	new	287713	Antracite	new
287706	Nero	new	287737	Nero	new
307169	Coffee	new	307176	Coffee	new



Style

Corpo luce in alluminio verniciato a polveri. Diffusore in materiale plastico opale. Sorgente luminosa a led integrato. Modello AP Sensor dotato di sensore PIR. Disponibile nelle finiture antracite o bianco.

LED Sorgente luminosa LED
3000/4000 K, 30.000 h di durata.

 Lampada con rilevazione di presenza inclusa PIR (Passive InfraRed).

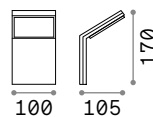

■  IP54

0,390 Kg / 0,0018 m³
LED 9W / 1050/1150 lm

€ 133

269139 ■ Bianco 3000K
221502 ■ Bianco 4000K
246857 ■ Antracite 3000K
209845 ■ Antracite 4000K

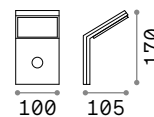

■  IP54 

0,400 Kg / 0,0018 m³
LED 9,5W / 1050/1150 lm

€ 165

269146 ■ Bianco 3000K
209852 ■ Bianco 4000K
246864 ■ Antracite 3000K
221519 ■ Antracite 4000K





Tronco

Corpo luce in alluminio pressofuso rifinito in vernice di colore antracite, bianco, grigio o nero. Diffusore in vetro pirex con elementi interni in alluminio.

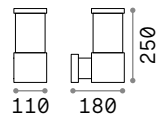

■ IP44

1,110 Kg / 0,0070 m³
E27 max 1x 42W

€ 64

118659 ■ Bianco
026978 ■ Grigio
027005 ■ Antracite
004716 ■ Nero

4000 K
490 lm
153957 € 3,00



Etere

Corpo luce in fusione di alluminio verniciato a polveri. Diffusore in materiale plastico color opale. Disponibile nelle finiture antracite o coffee.

LED Sorgente luminosa LED
3000/4000 K, 25.000 h di durata.

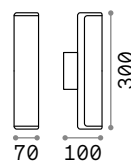

IP44

0,590 Kg / 0,0027 m³
LED 10W / 1020/1130 lm

€ 95

246925	■ Antracite	3000K
172408	■ Antracite	4000K
269153	■ Coffee	3000K
246949	■ Coffee	4000K



Snif Round

Corpo luce in alluminio pressofuso verniciato. Doppio diffusore, superiore e inferiore, in vetro pirex trasparente. Disponibile nelle finiture antracite, bianco, grigio o nero.

061467



144283



061474



061450

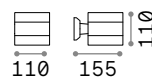

IP54

0,750 Kg / 0,0032 m³
G9 max 1x40W

€ 66

144283 ■ Bianco
061474 ■ Grigio
061467 ■ Antracite
061450 ■ Nero



4000 K
390 lm

209036 € 3,90



Snif Square

Corpo luce in alluminio pressofuso verniciato. Doppio diffusore, superiore e inferiore, in vetro pirex trasparente. Disponibile nelle finiture antracite, bianco, grigio o nero.

121963



144276



118666



123080

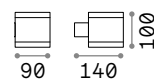

IP44

0,600 Kg / 0,0027 m³
G9 max 1x 40W

€ 56

144276 **Bianco**
118666 **Grigio**
121963 **Antracite**
123080 **Nero**

4000 K
390 lm
209036 € 3,90



Keope

Corpo luce e diffusore in resina ad alte prestazioni: inattaccabile dalla corrosione di agenti atmosferici; colori stabilizzati da trattamento U.V.. Resistente a sbalzi termici da -60° C a +90° C. Diffusori in materiale acrilico trasparente satinato.

LED Lampadine LED GU10 3,5W incluse.
CCT regolabile: 2700 K, 4000 K.



0,450 Kg / 0,0033 m³
GU10 max 2 x 6W

€ 63

147772 ■ Bianco
147796 ■ Grigio
147819 ■ Nero

3000 K
440 lm

108292 € 4,50



0,350 Kg / 0,0033 m³
GU10 max 1 x 6W

€ 42

147765 ■ Bianco

3000 K
440 lm

108292 € 4,50



Apollo

Corpo luce in alluminio pressofuso rifinito con vernice opaca a polveri in colore bianco o nero. Emissione luce sopra e sotto.

LED Sorgente luminosa LED 4000 K, 30.000 h di durata.



IP44

0,540 Kg / 0,0008 m³
LED 6W / 800 lm

€ 90

137407 ■ Bianco
137391 ■ Nero



Gun

Corpo luce in alluminio con finitura naturale spazzolata o in vernice con varie finiture. Diffusore in vetro pirex trasparente. Emissione luce sopra e sotto.



100388

033013

163628



236841

100395

163635

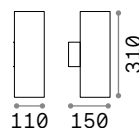

110

150

310

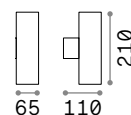

65

110

210



IP54



IP44

1,350 Kg / 0,0071 m³
E27 max 2 x 60W

€ 72

0,720 Kg / 0,0024 m³
GU10 max 2 x 35W

€ 63

092300 Bianco
033020 Alluminio
163604 Grigio
236858 Antracite
092317 Nero
163611 Coffee

100388 Bianco
033013 Alluminio
163628 Grigio
236841 Antracite
100395 Nero
163635 Coffee

4000 K
600 lm

151960 € 2,50

4000 K
500 lm

253497 € 4,50



P. 727



Base

Corpo luce in alluminio pressofuso rifinito con vernice a polveri opaca di colore bianco, grigio o nero. Doppio diffusore, superiore e inferiore, in vetro temperato trasparente.



129457

129440

129433

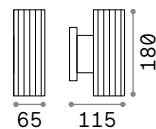

IP44

0,610 Kg / 0,0016 m³
GU10 max 2 x 28W

€ 40

129457 ■ Bianco
129440 ■ Grigio
129433 ■ Nero

4000 K
500 lm

253497 € 4,50



Iko

Corpo luce in alluminio pressofuso verniciato a polveri. Doppio diffusore, superiore e inferiore, in vetro temperato trasparente e sabbato. Disponibile nelle finiture antracite, bianco o grigio.

018515



092218



018522

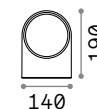
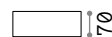

IP54

0,600 Kg / 0,0040 m³
E27 max 1x60W

€ 55

018522 ■ Bianco
092218 ■ Grigio
018515 ■ Antracite

4000 K
600 lm

151960 € 2,50



Up

Corpo luce in fusione di alluminio verniciato a polveri. Diffusori in vetro pirex trasparente. Disponibile nelle finiture antracite, bianco, coffee o nero.

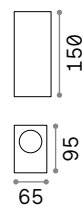

IP44

0,520 Kg / 0,0019 m³
G9 max 2x 15W

€ 58

115320 ■ Bianco
115337 ■ Antracite
115344 ■ Nero
213354 ■ Coffee

4000 K
390 lm
209036 € 3,90

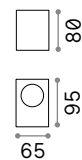

IP44

0,320 Kg / 0,0012 m³
G9 max 1x 15W

€ 38

115290 ■ Bianco
115306 ■ Antracite
115313 ■ Nero
213347 ■ Coffee

4000 K
390 lm
209036 € 3,90



Rubik

Corpo luce in fusione di alluminio verniciato a polveri. Struttura interna che riflette il fascio luminoso sia sopra sia sotto. Disponibile nelle finiture antracite, bianco o nero.

LED Sorgente luminosa LED
3000/4000 K, 30.000 h di durata.



149745



149738



142302



■ IP44

0,660 Kg / 0,0022 m³
LED 8,5W / 700/730 lm

€ 135

269313	Bianco	3000K
149745	Bianco	4000K
247083	Antracite	3000K
149738	Antracite	4000K
269320	Nero	3000K
142302	Nero	4000K



Tetris-1

Corpo luce in alluminio rifinito con vernice opaca a polveri. Diffusore in vetro temperato trasparente. Disponibile nelle finiture antracite, bianco, coffee o grigio.

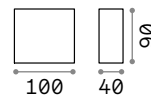

IP44

0,390 Kg / 0,0017 m³
G9 max 1x 15W

€ 82

114293 Bianco
113760 Grigio
113753 Antracite
213323 Coffee

4000 K
390 lm
209036 € 3,90

Tetris-2

Corpo luce in alluminio rifinito con vernice opaca a polveri di colore antracite o bianco. Diffusore in vetro temperato trasparente. Emissione luce sopra e sotto.

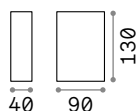

IP44

0,520 Kg / 0,0018 m³

G9 max 2 x 15W

€ 91

269221 Bianco

113791 Antracite

4000 K
390 lm

209036 € 3,90



Argo

Corpo luce in alluminio pressofuso verniciato a polveri. Diffusore in vetro temperato trasparente con riflettore interno bianco. Disponibile nelle finiture antracite o bianco.

LED Sorgente luminosa LED
3000/4000 K, 20.000 h di durata.

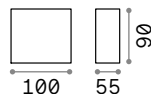

IP65

0,600 Kg / 0,0013 m³

LED 10W / 1050/1150 lm

€ 76

268309 Bianco 3000K

268316 Bianco 4000K

250946 Antracite 3000K

268293 Antracite 4000K





Twin

Corpo luce in alluminio pressofuso verniciato a polveri di colore antracite, bianco, coffee o nero. Doppio diffusore, superiore e inferiore, in vetro pirex trasparente satinato.

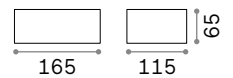

■ IP44

0,510 Kg / 0,0026 m³
G9 max 1x28W

€ 51

115351 ■ Bianco
115368 ■ Antracite
115375 ■ Nero
213330 ■ Coffee

4000 K
390 lm
209036 € 3,90



Andromeda

Corpo luce in alluminio pressofuso verniciato. Doppio diffusore, superiore e inferiore, in vetro pirex satinato. Disponibile nelle finiture antracite, bianco, coffee, grigio o nero.

100364



163543



092355



100371



163550

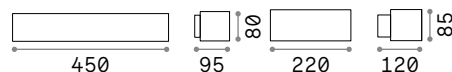

IP55

1,630 Kg / 0,0052 m³
E27 max 2x60W

€ 85

100364 ■ Bianco
163543 ■ Grigio
092355 ■ Antracite
100371 ■ Nero
163550 ■ Coffee

4000 K
600 lm

151960 € 2,50

IP55

1,000 Kg / 0,0039 m³
E27 max 1x60W

€ 54

066868 ■ Bianco
158822 ■ Grigio
061580 ■ Antracite
061597 ■ Nero
163536 ■ Coffee

4000 K
600 lm

151960 € 2,50



Giove

Corpo luce in alluminio pressofuso verniciato a polveri. Doppio diffusore, superiore e inferiore, in vetro temperato trasparente sabbato. Disponibile nelle finiture antracite, bianco, coffee o nero.



092195



092188



092201



163598

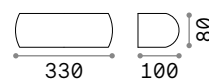

IP54

0,900 Kg / 0,0041 m³
E27 max 1x60W

€ 68

092195 ■ Bianco
092188 ■ Antracite
092201 ■ Nero
163598 ■ Coffee

4000 K
600 lm

151960 € 2,50



Felix

Corpo luce e diffusore in resina ad alte prestazioni: inattaccabile dalla corrosione sia di agenti atmosferici che di fertilizzanti chimici, colori stabilizzati da trattamento U.V., resistente a sbalzi termici da -60° C a + 90° C.



123776



123769



123783

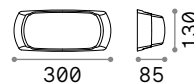
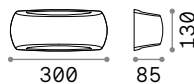

0,520 Kg / 0,0050 m³
E27 max 1x23W

0,610 Kg / 0,0050 m³
E27 max 1x23W

€ 52

€ 35

123745 ■ Bianco

123776 ■ Bianco

123769 ■ Grigio

123783 ■ Nero

4000 K
600 lm

4000 K
600 lm

151960

€ 2,50

151960

€ 2,50



Rex-1

Corpo luce in alluminio pressofuso verniciato a polveri di colore antracite, bianco o coffee. Diffusore bianco in materiale acrilico.

092393



092409



213217

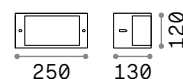

IP44

0,600 Kg / 0,0065 m³
E27 max 1x60W

€ 42

092393 ■ Bianco
092409 ■ Antracite
213217 ■ Coffee

4000 K
1000 lm

151991 € 2,50

Rex-2

Corpo luce in alluminio pressofuso verniciato a polveri di colore antracite o bianco. Diffusore bianco in materiale acrilico.

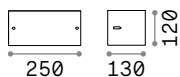

IP44

0,600 Kg / 0,0065 m³
E27 max 1x60W

€ 42

092416 ■ Bianco
092423 ■ Antracite

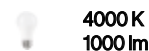

151991 € 2,50



Rex-3

Corpo luce in alluminio pressofuso verniciato a polveri di colore antracite o bianco. Diffusore bianco in materiale acrilico.

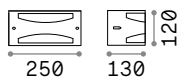

IP44

0,600 Kg / 0,0065 m³
E27 max 1x60W

€ 42

092430 ■ Bianco
092447 ■ Antracite

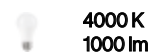

151991 € 2,50





Cometa

Corpo luce in alluminio pressofuso rifinito con vernice a polveri di colore antracite o nero. Diffusore in PVC bianco. È sconsigliato esporre l'articolo a contatto diretto con i raggi solari.



082240



082271

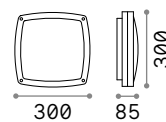

1,500 Kg / 0,0124 m³
E14 max 3x28W

€ 100

082240 ■ Antracite
082271 ■ Nero

3000 K
420 lm

101217 € 3,00

Polar

Corpo luce e diffusore in resina ad alte prestazioni: inattaccabile dalla corrosione sia di agenti atmosferici che di fertilizzanti chimici, colori stabilizzati da trattamento U.V., resistente a sbalzi termici da -60°C a $+90^{\circ}\text{C}$.

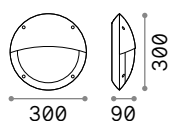
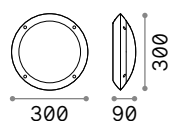

0,800 Kg / 0,0106 m³
E27 max 1x23W

€ 31

096667 Bianco
096674 Nero

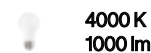

151991 € 2,50

0,800 Kg / 0,0106 m³
E27 max 1x23W

€ 22

096681 Bianco
096698 Nero

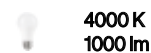

151991 € 2,50



096681

096698

Medea

Corpo luce e diffusore in resina ad alte prestazioni: inattaccabile dalla corrosione sia di agenti atmosferici che di fertilizzanti chimici, colori stabilizzati da trattamento U.V., resistente a sbalzi termici da -60°C a $+90^{\circ}\text{C}$.

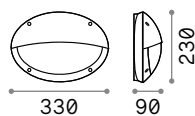
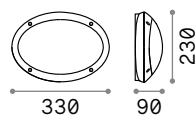

0,800 Kg / 0,0109 m³
E27 max 1x23W

€ 23

096711 Bianco
096704 Nero

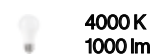

151991 € 2,50

0,800 Kg / 0,0109 m³
E27 max 1x23W

€ 23

096735 Bianco
096728 Nero

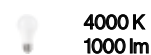

151991 € 2,50



096735

096728



Bubble

Montatura in alluminio pressofuso e tornito rifinito con vernici a polveri. Diffusore in materiale plastico bianco opaco.

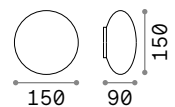

0,480 Kg / 0,0031 m³
G9 max 2x15W

€ 72

158907 Bianco

4000 K
390 lm

209036 € 3,90



P. 730



Clio

Articolo componibile con montatura in alluminio estruso e tornito, rifinito con vernici a polveri di colore antracite, bianco, grigio e nero. Diffusore in materiale plastico bianco opaco.

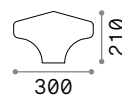
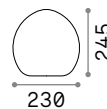
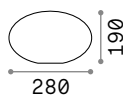
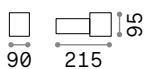

0,680 Kg / 0,0039 m³
E27 max 1x 42W

€ 71

146775 ■ Bianco
146782 ■ Grigio
145228 ■ Antracite
146799 ■ Nero

0,540 Kg / 0,0171 m³

€ 35

145068 ■ Bianco

0,520 Kg / 0,0144 m³

€ 35

116716 ■ Bianco

0,610 Kg / 0,0231 m³

€ 35

145020 ■ Bianco

4000 K
600 lm
151960 € 2,50



P. 724 P. 724 P. 812



Cima

Corpo luce interamente in alluminio pressofuso. Con finitura antracite, coffee o nero e oro. Diffusore in acrilico trasparente.

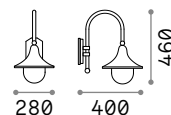

IP43

1,840 Kg / 0,0504 m³
E27 max 1x 60W

€ 61

246819 ■ Antracite
024134 ■ Nero
246826 ■ Coffee

4000 K
980 lm

153964 € 7,00



P. 814



Dafne

Corpo luce in resina ad alte prestazioni: inattaccabile dalla corrosione, colori stabilizzati da trattamento U.V., resistente a sbalzi termici da -60° C a +90° C. Diffusore in metacrilato antiingiallimento.



120423



101491

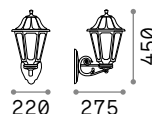

220 275 450

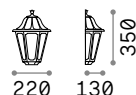

220 130 350



IP55



IP55

1,000 Kg / 0,0101 m³
E27 max 1x23W

€ 31

0,600 Kg / 0,0117 m³
E27 max 1x23W

€ 27

120423 ■ Bianco
101491 ■ Nero

120430 ■ Bianco
101552 ■ Nero



4000 K
980 lm

153964

€ 7,00



4000 K
980 lm

153964

€ 7,00



P. 815



Down

Montatura in alluminio pressofuso verniciato a polveri con finitura antracite o bianca. Diffusore in acrilico.



115382



122045

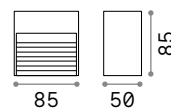

IP44

0,270 Kg / 0,0010 m³
G9 max 1x28W

€ 30

115382 ■ Bianco
122045 ■ Antracite

4000 K
390 lm
209036 € 3,90



Febe

Apparecchio da installazione su superficie con corpo luce in alluminio pressofuso verniciato a polveri. Diffusore in vetro temperato trasparente. Disponibile nelle finiture antracite o bianco.

LED Sorgente luminosa LED 3000 K, 20.000 h di durata.



268361

268354

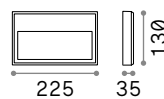
225
35

0,760 Kg / 0,0020 m³
LED 6W / 600 lm

€ 83

268347 ■ Bianco
250854 ■ Antracite

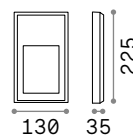
130
35

0,760 Kg / 0,0020 m³
LED 6W / 500 lm

€ 80

268361 ■ Bianco
268354 ■ Antracite



Esterni

Bollard e lampade da tavolo



Indice alfabetico

Acqua	797	Tesla	794
Agos	788	Tifone	798
Atena	804	Titano	792
Cima	814	Torre	808
Classic Globe	811	Tronco	802
Clio	812	Vega	800
Cosmo	809	Venus	805
Dafne	815		
Djambe	781		
Doris	782		
Edo Outdoor	807		
Elon	796		
Etere	806		
Gas	796		
Hub	787		
Ipotesi	799		
Itaca	786		
Jedi	801		
Kurt	793		
Lolita	778		
Luna	784		
Marte	810		
Mercurio	810		
Path	795		
Pulsar	805		
Sasso	785		
Sirio	790		
Sole	783		
Stardust	779		
Style	789		
Sun	780		

Djambe

Pag 767



new



Lolita 778



Stardust 779

new



Sun 780



Agos 788



Style 789



Sirio 790

new



Tifone 798



Ipotesi 799



Vega 800



Torre 808



Cosmo 809



Marte 810

Esterni

Indice icone

new



Djambe 781



Doris 782



Sole 783



Luna 784



Sasso 785



Itaca 786



Hub 787

new



Titano 792



Kurt 793



Tesla 794



Path 795



Gas 796

new



Elon 796



Acqua 797

new



Jedi 801



Tronco 802



Atena 804



Pulsar 805



Venus 805



Etere 806



Edo Outdoor 807



Mercurio 810



Classic Globe 811



Clio 812



Clio 812



Clio 812



Cima 814



Dafne 815



Lolita **new**

Lampada da tavolo a batteria ricaricabile con finitura bianca, grigia, nera o coffee. Montatura in metallo. Diffusore in materiale plastico. Autonomia di 14 ore. Tempo di ricarica della batteria 7 ore.



Sorgente luminosa LED 3000 K, 25.000 h di durata.



Lampada con interruttore integrato.



Lampada con dimmer.



Lampada con dimmer tattile.



Lampada con batteria ricaricabile inclusa. Durata 14 ore.



286723

286730

286716

286747



IP54

0,550 Kg / 0,0078 m³

LED 7W / 200 lm

€ 90

286723 **Bianco** **new**

286730 **Grigio** **new**

286716 **Nero** **new**

286747 **Coffee** **new**



Stardust

Lanterna portatile a batteria.
Montatura in alluminio pressofuso
verniciato a polveri con finitura
antracite con elementi in vetro nero
sulla parte superiore. Diffusore
in vetro temperato trasparente.
Emissione luce verso il basso.

LED Sorgente luminosa LED 3000 K,
20.000 h di durata.

ON/OFF Lampada con interruttore integrato.

+ Lampada con dimmer.

B Lampada con batteria ricaricabile
inclusa. Durata 7 ore.

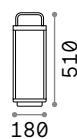

IP54

2,780 Kg / 0,0191 m³
LED 3W / 330 lm

€ 147

250885 ■ Antracite

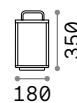

IP54

2,630 Kg / 0,0130 m³
LED 3W / 330 lm

€ 135

250878 ■ Antracite



Sun **new**

Apparecchio portatile a batteria.
Base in alluminio verniciato a polveri.
Diffusore in vetro bianco soffiato e acidato. Finiture: bianco. Autonomia di 7 ore. Tempo di ricarica della batteria 4 ore.



LED Sorgente luminosa LED 3000 K,
30.000 h di durata.

**ON
OFF** Lampada con interruttore integrato.

Battery icon Lampada con batteria ricaricabile
inclusa. Durata 7 ore.



IP44

0,400 Kg / 0,0097 m³
LED 5,5W / 230 lm

€ 85

278148 **Bianco** **new**



Djambe **new**

Corpo luce in metallo verniciato a polveri. Diffusore in materiale plastico opale ruvido. Emissione luce in basso. Cavo in neoprene nero con spina. Finiture: coffee oppure nero.

LED Sorgente luminosa LED 3000 K, 30.000 h di durata.

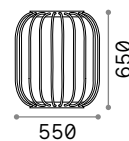

550

650

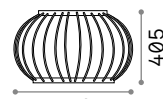

740

405

IP44

IP44

6,300 Kg / 0,1884 m³
LED 18W / 2300 lm

8,000 Kg / 0,1654 m³
LED 18W / 2300 lm

€ 397

€ 479

293394 ■ Nero **new** 293424 ■ Nero **new**
293387 ■ Coffee **new** 293417 ■ Coffee **new**



293394



293387



Doris

Diffusore in materiale plastico grigio melange effetto granito. Fornito con spina e picchetto per fissaggio nel terreno.

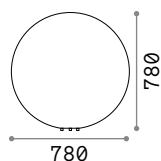

IP44

7,600 Kg / 0,5581 m³
E27 max 1x 60W

€ 545

195506 Bianco

4000 K
1000 lm

151991 € 2,50

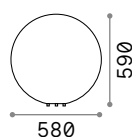

IP44

4,050 Kg / 0,2306 m³
E27 max 1x 60W

€ 325

195490 Bianco

4000 K
1000 lm

151991 € 2,50

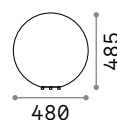

IP44

3,000 Kg / 0,1366 m³
E27 max 1x 60W

€ 215

195483 Bianco

4000 K
1000 lm

151991 € 2,50

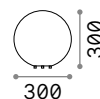

IP44

1,210 Kg / 0,0318 m³
E27 max 1x 60W

€ 127

214009 Bianco

4000 K
1000 lm

151991 € 2,50



Sole

Diffusore in materiale plastico opale. Fornito con spina e picchetto per terreno.

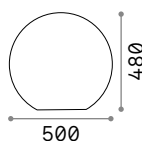

4,500 Kg / 0,1460 m³
E27 max 1x60W

€ 250

191614 Bianco

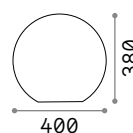

3,900 Kg / 0,0741 m³
E27 max 1x60W

€ 175

191621 Bianco

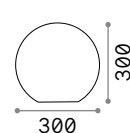

2,700 Kg / 0,0322 m³
E27 max 1x60W

€ 145

191638 Bianco

 4000 K
1000 lm
151991 € 2,50

 4000 K
1000 lm
151991 € 2,50

 4000 K
1000 lm
151991 € 2,50



P. 722



Luna

Corpo luce diffusore in materiale plastico opale. Fornito con spina e picchetto per terreno.

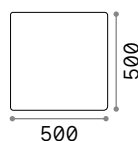

IP44

6,700 Kg / 0,1743 m³
E27 max 1x60W

€ 357

191607 Bianco

4000 K
1000 lm

151991 € 2,50

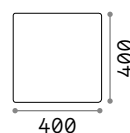

IP44

4,700 Kg / 0,1005 m³
E27 max 1x60W

€ 237

191584 Bianco

4000 K
1000 lm

151991 € 2,50

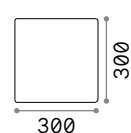

IP44

2,700 Kg / 0,0356 m³
E27 max 1x60W

€ 169

191577 Bianco

4000 K
1000 lm

151991 € 2,50



P.723



Sasso

Diffusore in materiale plastico opale. Fornito di cavo con spina e picchetto per fissaggio a terra.

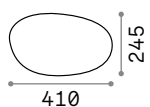

1,500 Kg / 0,0444 m³
E27 max 1x 40W

€ 205

161778 Bianco

 4000 K
1000 lm
151991 € 2,50

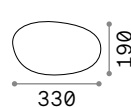

0,900 Kg / 0,0209 m³
E27 max 1x 40W

€ 145

161761 Bianco

 4000 K
1000 lm
151991 € 2,50

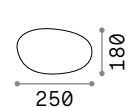

0,710 Kg / 0,0123 m³
G9 max 1x 15W

€ 105

161754 Bianco

 4000 K
390 lm
209036 € 3,90



Itaca

Base e stelo in metallo verniciato a polveri di colore bianco. Diffusore conico in materiale plastico color opale. Fornito con spina.

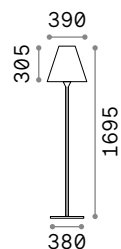

IP44

11,040 Kg / 0,1385 m³
E27 max 1x60W

€ 310

180953 Bianco

4000 K
1000 lm

151991 € 2,50



Hub

Base, asta e corpo luce in alluminio verniciato a polveri. Diffusore orientabile con schermo in vetro temperato trasparente. Fornito di picchetto per fissaggio a terra. Disponibile nella finitura antracite.

LED Sorgente luminosa LED
3000 K, 30.000 h di durata.

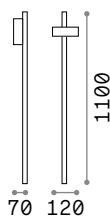

IP54

0,850 Kg / 0,0057 m³
LED 4,5W / 410 lm

€ 132

251257 ■ Antracite

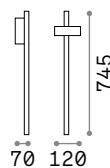

IP54

0,720 Kg / 0,0083 m³
LED 4,5W / 410 lm

€ 132

251226 ■ Antracite

5
150

Base
Non incluso
Optional

€ 32

251295 ■ Antracite



Agos

Corpo luce in alluminio pressofuso verniciato a polveri. Diffusore in acrilico trasparente satinato. Colore antracite.

LED Sorgente luminosa LED
3000/4000 K, 25.000 h di durata.



IP54

1,100 Kg / 0,0127 m³
LED 6,5W / 670/730 lm

€ 141

254319 ■ Antracite 3000K
268422 ■ Antracite 4000K

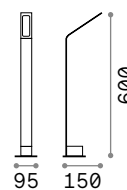

IP54

0,950 Kg / 0,0096 m³
LED 6,5W / 670/730 lm

€ 120

254388 ■ Antracite 3000K
268439 ■ Antracite 4000K



Style

Corpo luce in alluminio verniciato a polveri. Diffusore in materiale plastico opale. Sorgente luminosa a led integrato.

LED Sorgente luminosa LED
3000/4000 K, 30.000 h di durata.

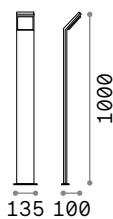

 IP54

1,670 Kg / 0,0239 m³
LED 9W / 850/920 lm

€ 190

246871 ■ Antracite 3000K
209906 ■ Antracite 4000K



P. 744



Sirio

Corpo luce in alluminio verniciato a polveri. Diffusore in vetro pirex trasparente. Disponibile nelle finiture antracite, bianco, coffee, grigio o nero.



115085

246963

115061

115108

213262

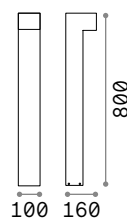

IP44

1,880 Kg / 0,0181 m³
G9 max 2x 15W

€ 165

- 115085 Bianco
- 246963 Grigio
- 115061 Antracite
- 115108 Nero
- 213262 Coffee

4000 K
390 lm
209036 € 3,90

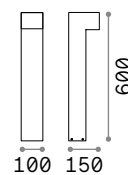

IP44

1,550 Kg / 0,0136 m³
G9 max 2x 15W

€ 130

- 115092 Bianco
- 246970 Grigio
- 115078 Antracite
- 115115 Nero
- 213279 Coffee

4000 K
390 lm
209036 € 3,90



Titano

Corpoluce in resina porosa. Base e dettaglio diffusore in metallo verniciato nero opaco. Emissione luce verso il basso. LED integrato.



Sorgente luminosa LED
3000/4000 K, 50.000 h di durata.

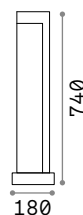

9,220 Kg / 0,0540 m³
LED 9W / 430/450 lm

€ 265

246987 ■ Granito 3000K
187327 ■ Granito 4000K

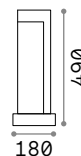

6,800 Kg / 0,0377 m³
LED 9W / 430/450 lm

€ 220

246994 ■ Granito 3000K
157856 ■ Granito 4000K



Kurt ^{new}

Base e corpo luce in alluminio verniciato a polveri. Diffusore in vetro trasparente. Emissione luce verso il basso. Finiture: antracite, bianco, coffee, grigio oppure nero.

LED Sorgente luminosa LED
3000/4000 K, 30.000 h di durata.



IP54

1,930 Kg / 0,0060 m³
LED 11W / 950/1000 lm

€ 125

306841	Bianco	3000K	^{new}	294025	Antracite	4000K	^{new}
294049	Bianco	4000K	^{new}	306872	Nero	3000K	^{new}
306865	Grigio	3000K	^{new}	293172	Nero	4000K	^{new}
294032	Grigio	4000K	^{new}	306858	Coffee	3000K	^{new}
306834	Antracite	3000K	^{new}	294001	Coffee	4000K	^{new}



306841 306865 306834 306872 306858



Tesla

Corpo luce in alluminio verniciato a polveri. Diffusore con schermo in materiale plastico bianco. Emissione luce verso il basso. Disponibile nelle finiture antracite o bianco.

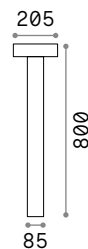

IP44

3,000 Kg / 0,0379 m³
G9 max 4 x 15W

€ 155

153179 ■ Bianco
153162 ■ Antracite

4000 K
390 lm
209036 € 3,90

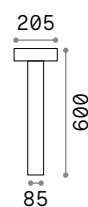

IP44

2,560 Kg / 0,0273 m³
G9 max 4 x 15W

€ 145

153209 ■ Bianco
153193 ■ Antracite

4000 K
390 lm
209036 € 3,90



Path

Corpo luce in alluminio verniciato a polveri. Diffusore in policarbonato opale. Colore: antracite metallizzato.

LED Sorgente luminosa LED
3000/4000 K, 20.000 h di durata.



285542-250816



285559-250823

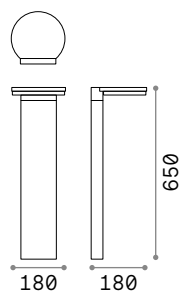

IP65

1,900 Kg / 0,0238 m³
LED 10W / 1200/1250 lm

€ 135

285542 ■ Antracite 3000K
250816 ■ Antracite 4000K

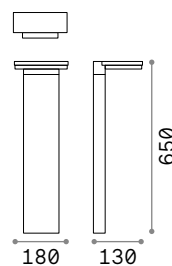

IP65

1,840 Kg / 0,0163 m³
LED 10W / 1200/1250 lm

€ 135

285559 ■ Antracite 3000K
250823 ■ Antracite 4000K

Gas

Corpo luce in alluminio pressofuso verniciato a polveri. Diffusore in vetro temperato trasparente sabbiato. Disponibile nelle finiture antracite o coffee.

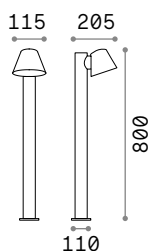

1,790 Kg / 0,0216 m³
GU10 max 1x35W

€ 116

139470 ■ Antracite
213101 ■ Coffee

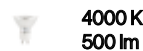

253497 € 4,50 P. 740



Elon new

Corpo luce e diffusore in resina ad alte prestazioni: anti corrosione, anti U.V., da -60°a +90° C. Con pannello fotovoltaico. Emissione luce in basso. Finiture: nero.



Sorgente luminosa LED. CCT regolabile: 3000 K, 4000 K, 6500 K. 20.000 h di durata.



1,660 Kg / 0,0220 m³
LED 2,5W / 280 Lm

€ 145

294124 ■ Nero new





Acqua

Corpo luce in alluminio tornito rifinito in vernice opaca con finitura antracite o coffee. Diffusore in vetro temperato.

135205



246918

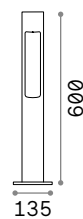

IP44

1,500 Kg / 0,0164 m³
G9 max 1x 15W

€ 160

135205 ■ Antracite
246918 ■ Coffee

4000 K
390 lm
209036 € 3,90



Tifone

Base e montatura in alluminio pressofuso verniciato a polveri con finitura antracite. Diffusore in vetro temperato trasparente. Emissione luce in basso.

LED Sorgente luminosa LED
3000 K, 20.000 h di durata.

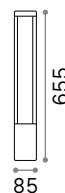

IP65

1,250 Kg / 0,0054 m³
LED 8,5W / 720 Lm

€ 122

250953 ■ Antracite

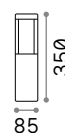

IP65

1,010 Kg / 0,0029 m³
LED 8,5W / 720 Lm

€ 105

250977 ■ Antracite



Ipotesi **new**

Montatura interamente in alluminio verniciato a polveri. Diffusore in policarbonato opale. Cavo nero in gomma con interruttore, driver esterno incorporato e spina. Colore: bianco o nero.

LED Sorgente luminosa LED
3000 K, 30.000 h di durata.

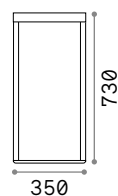

350

730



500

500

IP44

IP44

5100 Kg / 0,0513 m³
LED 16W / 1800 Lm

4,940 Kg / 0,1379 m³
LED 16W / 1800 Lm

€ 335

€ 435

282244 ■ Bianco **new** 300641 ■ Bianco **new**
282251 ■ Nero **new** 300658 ■ Nero **new**



282244

282251



Vega

Corpo luce in alluminio con finitura in vernice opaca a polveri. Diffusore in vetro temperato trasparente. Disponibile nelle finiture antracite, bianco, coffee, grigio o nero.

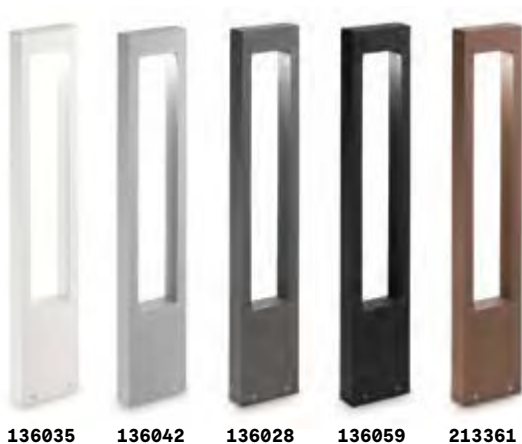

136035

136042

136028

136059

213361

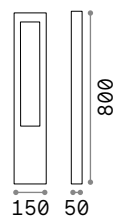

IP44

1,150 Kg / 0,0092 m³
G9 max 1x15W

€ 180

136035 Bianco
136042 Grigio
136028 Antracite
136059 Nero
213361 Coffee

4000 K
390 lm
209036 € 3,90



Jedi ^{new}

Base e corpo luce in alluminio verniciato a polveri. Diffusore in policarbonato opale lucido. Fornito con picchetto per installazione su terreno. Finiture: antracite oppure nero.

LED Sorgente luminosa LED 3000 K, 30.000 h di durata.

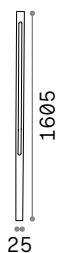

1,280 Kg / 0,0168 m³
LED 25W / 2950 Lm

€ 135

306803 ■ Antracite ^{new} 293202 ■ Nero ^{new}

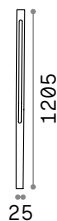

1,030 Kg / 0,0128 m³
LED 19W / 2250 Lm

€ 110

306797 ■ Antracite ^{new} 293196 ■ Nero ^{new}

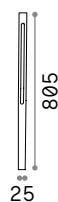

0,760 Kg / 0,0088 m³
LED 12W / 1400 Lm

€ 80

306780 ■ Antracite ^{new} 293189 ■ Nero ^{new}



Base
Non incluso
Optional

€ 10

308227 ■ Antracite ^{new} 308234 ■ Nero ^{new}



306803



293202



Tronco

Corpo luce in alluminio pressofuso rifinito in vernice di colore antracite, bianco, coffee, grigio o nero. Diffusore in vetro pirex con elementi interni in alluminio.

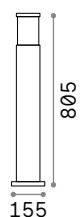

IP44

2,490 Kg / 0,0254 m³
E27 max 1x 42W

€ 146

109138 Bianco
026961 Grigio
026992 Antracite
004723 Nero
163741 Coffee



4000 K
490 lm

153957 € 3,00

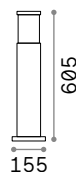

IP44

1,970 Kg / 0,0193 m³
E27 max 1x 42W

€ 125

109145 Bianco
026954 Grigio
026985 Antracite
004730 Nero
163758 Coffee



4000 K
490 lm

153957 € 3,00

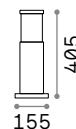

IP44

0,590 Kg / 0,0135 m³
E27 max 1x 42W

€ 113

248264 Bianco
248288 Grigio
248257 Antracite
248295 Nero
248271 Coffee



4000 K
490 lm

153957 € 3,00



P. 746



Atena

Corpo luce e diffusore in resina ad alte prestazioni: anti corrosione, colori stabilizzati da trattamento U.V., resistente da -60° C a + 90° C.

LED

Lampadine LED E27 8W Goccia incluse. CCT regolabile: 2700 K, 4000 K, 6500 K.

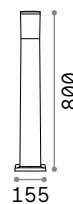

IP55

1,070 Kg / 0,0220 m³
E27 max 1x23W

€ 83

198644 Bianco
198637 Grigio
198620 Nero

 4000 K
1000 lm

151991 € 2,50

Pulsar

Montatura in fusione d'alluminio verniciato a polveri di colore antracite, coffee o grigio. Diffusore in policarbonato bianco.

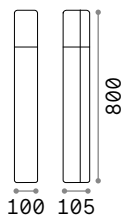

IP44

1,900 Kg / 0,0120 m³
E27 max 1x 42W

€ 200

135922 ■ Grigio
135908 ■ Antracite
246888 ■ Coffee

4000 K
600 lm
151960 € 2,50

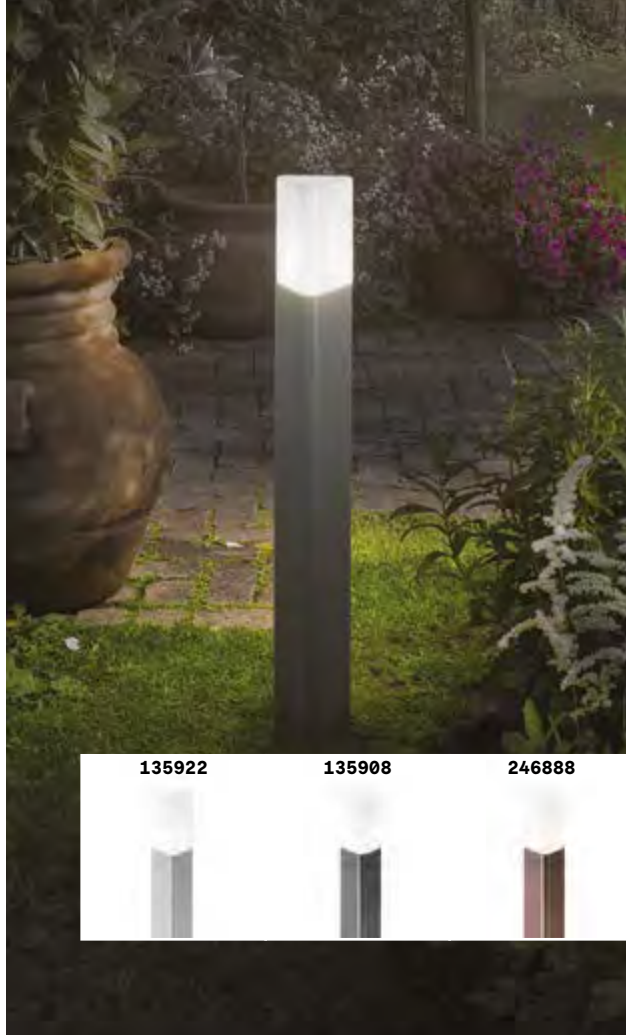

Venus

Corpo luce in lamina d'acciaio disponibile con finitura spazzolata o antracite. Elemento diffusore superiore in acrilico satinato.



IP44

1,410 Kg / 0,0137 m³
GU10 max 1x 15W

€ 105

106175 ■ Antracite

4000 K
500 lm
253497 € 4,50

IP44

1,070 Kg / 0,0103 m³
GU10 max 1x 15W

€ 95

106182 ■ Antracite

4000 K
500 lm
253497 € 4,50





Etere

Corpo luce in fusione di alluminio verniciato a polveri. Diffusore in materiale plastico color opale. Disponibile nelle finiture antracite o coffee.

LED Sorgente luminosa LED 3000/4000 K, 25.000 h di durata.

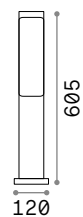

IP44

1,100 Kg / 0,0103 m³
LED 10W / 1020/1130 lm

€ 127

246932	Antracite	3000K
172439	Antracite	4000K
269160	Coffee	3000K
246956	Coffee	4000K



Edo Outdoor

Montatura in fusione d'alluminio verniciato a polveri di colore antracite, bianco o coffee. Diffusore in policarbonato bianco.

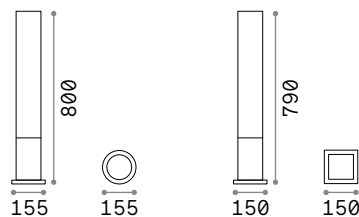

IP44

IP44

1,600 Kg / 0,0240 m³
GX53 max 1x15W

2,670 Kg / 0,0269 m³
GX53 max 1x15W

€ 132

€ 132

135755 Bianco
138510 Antracite
213071 Coffee

142999 Bianco
135762 Antracite
213088 Coffee

4000 K
1000 lm
154008 € 6,00

4000 K
1000 lm
154008 € 6,00



Torre

Corpo luce in alluminio tornito verniciato a polveri con finitura antracite o nero. Diffusore in materiale plastico opale.

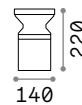
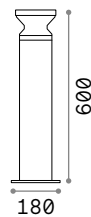

IP44

IP44

2,100 Kg / 0,0224 m³
E27 max 1x 15W

0,870 Kg / 0,0054 m³
E27 max 1x 15W

€ 140

€ 112

162492 ■ Antracite
186955 ■ Nero

158891 ■ Antracite
186979 ■ Nero

4000 K
600 lm

4000 K
600 lm

151960 € 2,50

151960 € 2,50



Cosmo

Corpo luce in resina resistente a corrosione, UV, a temperature da -60°a +90° C. Diffusore trasparente anti ingiallimento.

LED

Lampadine LED GX53 7W incluse.
CCT regolabile: 3000 K, 4000 K, 6500 K.



187877

187884

187891

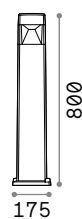

2,150 Kg / 0,0220 m³
GX53 max 1x10W

€ 92

187877 Bianco
187884 Grigio
187891 Nero

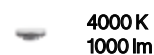

154008

€ 6,00

Marte

Corpo luce in alluminio verniciato a polveri con finitura antracite. Diffusore bianco in materiale acrilico.

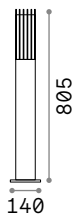

IP44

2,500 Kg / 0,0193 m³

E27 max 1x25W

€ 160

092225 ■ Antracite

4000 K
1000 lm

151991 € 2,50



Mercurio

Corpo luce in alluminio verniciato a polveri con finitura antracite. Diffusore in vetro pirex trasparente.

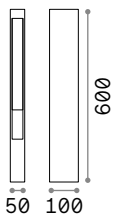

IP44

1,540 Kg / 0,0057 m³

G9 max 1x15W

€ 160

114347 ■ Antracite

4000 K
390 lm

209036 € 3,90

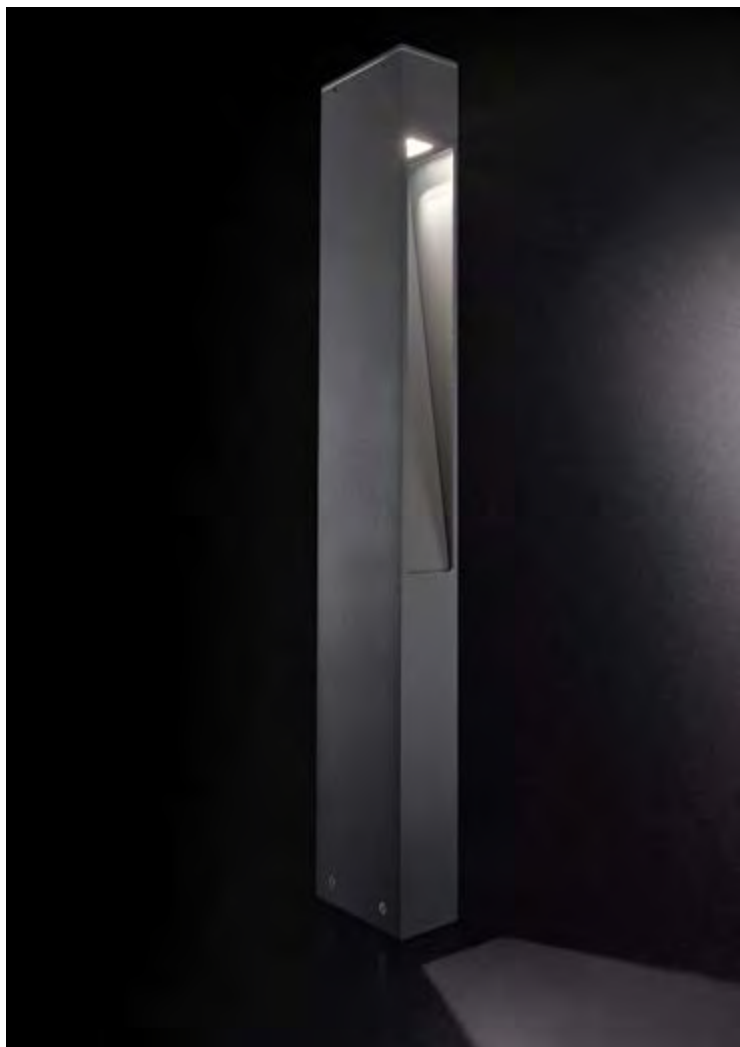



Classic Globe

Corpo luce in resina resistente a corrosione, UV, a temperature da -60° a +90° C. Diffusore anti ingiallimento disponibile nelle finiture bianco o trasparente.

<p>187556</p> <p>187525</p>	<p>300</p> <p>1300</p> <p>175</p> <p>IP55</p> <p>2,790 Kg / 0,1248 m³ E27 max 1x 23W</p> <p>€ 121</p> <p>187532 Trasparen. 187525 Bianco</p> <p>4000 K 1000 lm</p> <p>151991 € 2,50</p>	<p>300</p> <p>820</p> <p>175</p> <p>IP55</p> <p>2,050 Kg / 0,1015 m³ E27 max 1x 23W</p> <p>€ 100</p> <p>187556 Trasparen. 187549 Bianco</p> <p>4000 K 1000 lm</p> <p>151991 € 2,50</p>
-----------------------------	--	---

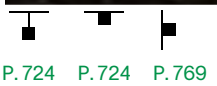

P.724 P.724 P.769

Clio

Articolo componibile con montatura in alluminio estruso e tornito, rifinito con vernici a polveri di colore antracite, bianco, grigio e nero. Diffusore in materiale plastico bianco opaco.

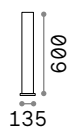

IP44

1,360 Kg / 0,0087 m³
E27 max 1x 42W

€ 84

249469 ■ Bianco
249476 ■ Grigio
249452 ■ Antracite
249483 ■ Nero

4000 K
600 lm
151960 € 2,50

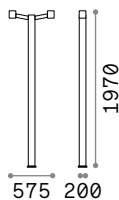

IP44

7,250 Kg / 0,0384 m³
E27 max 2x 42W

€ 250

249506 ■ Bianco
249513 ■ Grigio
249490 ■ Antracite
249520 ■ Nero

4000 K
600 lm
151960 € 2,50

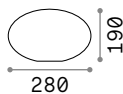

0,540 Kg / 0,0171 m³

€ 35

145068 ■ Bianco

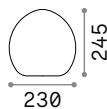

0,580 Kg / 0,0019 m³

€ 35

116716 ■ Bianco

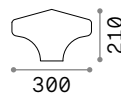

0,680 Kg / 0,0039 m³

€ 35

145020 ■ Bianco



Cima

Corpo luce interamente in alluminio pressofuso. Con finitura antracite, coffee o nero e oro. Diffusore in acrilico trasparente.



246833

024097

246840

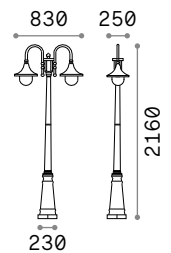

IP43

3,340 Kg / 0,1467 m³
E27 max 2 x 60W

€ 306

246833 ■ Antracite
024097 ■ Nero
246840 ■ Coffee

4000 K
980 lm

153964 € 7,00



P. 770



Dafne

Corpo luce in resina ad alte prestazioni: inattaccabile dalla corrosione, colori stabilizzati da trattamento U.V., resistente a sbalzi termici da -60° C a +90° C. Diffusore in metacrilato antingiallimento.



120454



101514



IP55

2,500 Kg / 0,0446 m³
E27 max 1x 23W

€ 85

120454 ■ Bianco
101514 ■ Nero

4000 K
980 lm

153964 € 7,00



P. 771



Esterni

Proiettori

Indice alfabetico

Elio	824
Inside	828
Litio	825
Starlight	820
Terra	826
Thor	818
Ulex	822
Zenith	829

Indice icone



Thor 818



Starlight 820



Ulex 822



Elio 824



Litio 825



Terra 826



Inside 828



Zenith 829

Thor

Proiettore lineare orientabile per installazione a superficie con effetto di luce radente. Corpo in alluminio pressofuso, diffusore in vetro trasparente. Sorgente luminosa a led integrato, disponibile in due lunghezze (500 mm e 1000 mm). Orientabilità +/-90° rispetto alla verticale, indice di protezione IP65, resistenza all'urto IK06, temperatura di colore 3000K, ingresso di alimentazione 24 Vdc; durata utile LED 50.000 h. Disponibile in opzione con visiera anti-abbagliamento.

Sorgente	LED SMD	Classe	III
Potenza	18W / 40W	isolamento	
Driver incluso	No	IP	65
Driver disponibili	On/Off	Materiale	Alluminio
CCT	3000 K		
CRI	≥80		
Durata LED	50.000 h		

PRO

Prodotto ad alto contenuto tecnologico, elevata qualità dei materiali, destinato ad uso professionale.

LED SMD OSRAM Driver non incluso

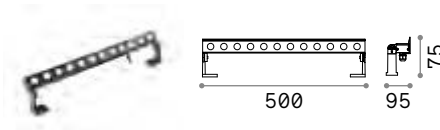

Potenza	Angolo	Lumen	CCT	Finitura	Codice	€
18W	30°	1950 lm	3000 K	Antracite	261331	215

1,490 Kg/0,0057 m³
Lunghezza cavo 500 mm

LED SMD OSRAM Driver non incluso

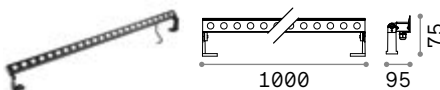

Potenza	Angolo	Lumen	CCT	Finitura	Codice	€
40W	30°	3900 lm	3000 K	Antracite	261355	325

2,460 Kg/0,0108 m³
Lunghezza cavo 500 mm

OPTIONAL Non incluso



	Potenza	Finitura	Codice	€
Visiera	18W	Antracite	261362	18
	40W	Antracite	261379	29

ON/OFF DRIVER Non incluso/Necessario

Potenza	Output	Misura	Codice	€
40 W	24 Vdc	171 x 37 x 61 mm	272108	100
100 W	24 Vdc	220 x 39 x 68 mm	226200	190
185 W	24 Vdc	220 x 39 x 68 mm	226217	210



Starlight

Proiettore orientabile in alluminio con fissaggio a plafone o con picchetto; superficie anodizzata e verniciata a polveri in grigio scuro; LED integrato ad efficienza energetica con elevata resa cromatica; disponibile in temperatura di colore 3000K e 4000K; durata utile LED 50.000 h. Visiera antiabbagliamento in opzione.

Sorgente	LED COB	Classe	III
Potenza	5,5W / 10W	isolamento	
Driver incluso	No	IP	68
Driver disponibili	On/Off	Materiale	Alluminio
CCT	3000 K / 4000 K		
CRI	≥80		
Durata LED	50.000 h		

PRO

Prodotto ad alto contenuto tecnologico, elevata qualità dei materiali, destinato ad uso professionale.

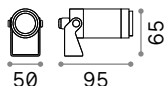

0,280 Kg/0,0005 m³

LED COB BRIDGELUX Driver non incluso

Potenza	Angolo	Lumen	CCT	Finitura	Codice	€
5,5 W	30°	600 lm	3000 K	Grigio Scuro	248394	120
		670 lm	4000 K	Grigio Scuro	245041	120

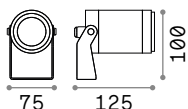

0,950 Kg/0,0014 m³

LED COB BRIDGELUX Driver non incluso

Potenza	Angolo	Lumen	CCT	Finitura	Codice	€
10 W	30°	1000 lm	3000 K	Grigio Scuro	248387	250
		1050 lm	4000 K	Grigio Scuro	245072	250

OPTIONAL Non incluso



	Potenza	Finitura	Codice	€
Visiera	5,5W	Grigio Scuro	245096	34
	10W	Grigio Scuro	245102	34
Connettore IP68		Nero	248615	22
Picchetto		Grigio Scuro	245089	17

ON/OFF DRIVER Non incluso/Necessario

Potenza	Output	Misura	Codice	€
20 W	24 Vdc	118 x 26 x 35 mm	226187	65
35 W	24 Vdc	148 x 30 x 40 mm	226194	70
100 W	24 Vdc	220 x 39 x 68 mm	226200	190
185 W	24 Vdc	220 x 39 x 68 mm	226217	210



Ulex

Proiettore orientabile per installazione a superficie, adatto per illuminazione generale o d'accento in esterni. Corpo in alluminio pressofuso, diffusore in vetro trasparente. Sorgente luminosa a led integrato, disponibile in due potenze. Indice di protezione IP65, resistenza all'urto IK06, temperatura di colore 3000K; durata utile LED 50.000 h. Disponibile in opzione con basetta di cablaggio, picchetto per installazione a terreno o visiera anti-abbagliamento.

Sorgente	LED SMD	Classe	I
Potenza	8,5W / 15W	isolamento	
Driver incluso	On/Off	IP	65
Driver disponibili	No	Materiale	Alluminio
CCT	3000 K		
CRI	≥80		
Durata LED	50.000 h		

PRO Prodotto ad alto contenuto tecnologico, elevata qualità dei materiali, destinato ad uso professionale.

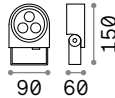

0,660 Kg/0,0025 m³
Lunghezza cavo 2000 mm

LED SMD OSRAM Driver ON/OFF incluso

Potenza	Angolo	Lumen	CCT	Finitura	Codice	€
8,5 W	30°	640 lm	3000 K	Antracite	261287	145

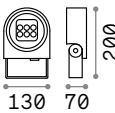

1,190 Kg/0,0042 m³
Lunghezza cavo 2000 mm

LED SMD OSRAM Driver ON/OFF incluso

Potenza	Angolo	Lumen	CCT	Finitura	Codice	€
15 W	30°	1280 lm	3000 K	Antracite	261294	220

OPTIONAL Non incluso



		Potenza	Finitura	Codice	€
Box	8,5 W	Antracite	268156	32	
	15 W	Antracite	268187	49	



		Potenza	Finitura	Codice	€
Picchetto	8,5 W	Antracite	268163	14	
	15 W	Antracite	268194	17	



		Potenza	Finitura	Codice	€
Visiera	8,5 W	Antracite	268170	17	
	15 W	Antracite	268200	25	





Elio

Corpo luce e diffusore in resina ad alte prestazioni: inattaccabile dalla corrosione sia di agenti atmosferici che di fertilizzanti chimici, colori stabilizzati da trattamento U.V., resistente a sbalzi termici da -60° C a + 90° C. Diffusore direzionabile.

LED Lampadine LED GU10 3,5W incluse.
CCT regolabile: 2700 K, 4000 K.

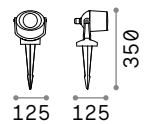

IP66  INCLUSE

0,360 Kg / 0,0027 m³
GU10 max 1x6W

€ 82

120218 ■ Bianco
120201 ■ Nero

 4000 K
500 lm
253497 € 4,50



Litio

Corpo luce e diffusore in resina ad alte prestazioni: inattaccabile dalla corrosione sia di agenti atmosferici che di fertilizzanti chimici, colori stabilizzati da trattamento U.V., resistente a sbalzi termici da -60° C a + 90° C. Diffusore direzionabile.

LED Lampadine LED GX53 7W incluse.
CCT regolabile: 3000 K, 4000 K, 6500 K.



145310

145334

145358

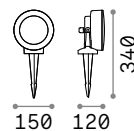

150 120

IP66

0,730 Kg / 0,0044 m³
GX53 max 1x10W

€ 90

145310 ■ Bianco
145334 ■ Grigio
145358 ■ Nero

4000 K
1000 lm

154008 € 6,00



P. 739



Terra

Montatura in fusione d'alluminio verniciata. Corpo luce posizionabile. Diffusore in vetro pirex trasparente.

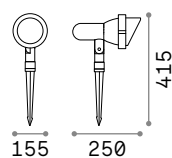

IP65

1,230 Kg / 0,0086 m³
E27 max 1x42W

€ 90

033044 ■ Antracite

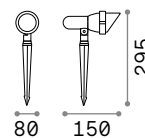

IP65

0,520 Kg / 0,0038 m³
GU10 max 1x28W

€ 52

106205 ■ Bianco
033037 ■ Antracite
046211 ■ Nero
163727 ■ Coffee

4000 K
600 lm
151960 € 2,50

4000 K
500 lm
253497 € 4,50



Inside

Montatura in fusione d'alluminio verniciato a polveri con finitura antracite, coffee o grigio. Corpo luce posizionabile. Diffusore in vetro pirex trasparente. Dotato di lancia da interrare.

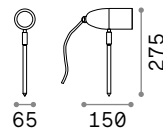

IP54

0,370 Kg / 0,0019 m³
G9 max 1x 15W

€ 36

115412 ■ Antracite
115429 ■ Nero
247045 ■ Coffee

4000 K
390 lm
209036 € 3,90



Zenith

Montatura in fusione d'alluminio
verniciata a polveri con finitura
antracite. Corpo luce posizionabile.
Diffusore in materiale plastico.

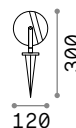

IP65

0,650 Kg / 0,0039 m³
GU10 max 1x11W

€ 62

108407 ■ Antracite

4000 K
500 lm

253497 € 4,50



Esterni

Incassi

Indice alfabetico

Avenue	835
Bit	832
Floor	837
Gravity	840
Indio	834
Landing	841
Park	838
Park Led	839
Rocket	843
Rocket Mini	842
Taurus	836
Way	843
Wire	833

Indice icone



Bit 832



Wire 833



Indio 834



Avenue Round 835



Avenue Square 835



Taurus 836



Floor 837



Park Round 838



Park Square 838



Park Led 839



Gravity Round 840



Gravity Square 840



Landing 841



Rocket Mini 842



Rocket Mini 842



Rocket Mini 842



Rocket 843



Rocket 843



Way 843



Way 843



Way 843



Bit

Corpo luce da incasso in alluminio pressofuso verniciato a polveri. Diffusore in vetro temperato trasparente. Disponibile nelle finiture antracite o bianco.

LED Sorgente luminosa LED 3000 K, 35.000 h di durata.

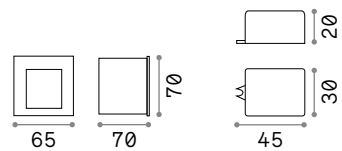

IP65

0,300 Kg / 0,0006 m³
LED 2W / 340 lm

€ 55

269023 ■ Bianco
269009 ■ Antracite

Driver
Non incluso
Necessario

€ 12

276205



Wire

Corpo luce da incasso in alluminio pressofuso verniciato a polveri. Diffusore in vetro temperato trasparente. Disponibile nelle finiture antracite o bianco.

LED Sorgente luminosa LED 3000 K, 20.000 h di durata.



255521

268996

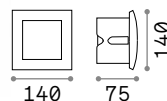

IP65

0,460 Kg / 0,0018 m³
LED 4W / 200 lm

€ 56

268989 ■ Bianco
255514 ■ Antracite

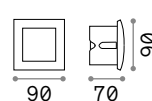

IP65

0,220 Kg / 0,0009 m³
LED 1,5W / 55 lm

€ 38

268996 ■ Bianco
255521 ■ Antracite



Indio

Corpo luce a incasso in alluminio pressofuso verniciato a polveri. Diffusore in vetro temperato serigrafato in bianco.



Sorgente luminosa LED 3000 K, 35.000 h di durata.

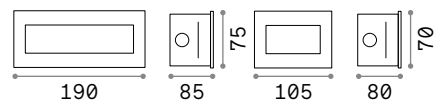

IP65

1,090 Kg / 0,0023 m³
LED 8W / 960 lm

€ 144

255804 Bianco

IP65

0,540 Kg / 0,0011 m³
LED 5W / 440 lm

€ 95

255781 Bianco



Avenue

Corpo luce e diffusore in resina ad alte prestazioni: inattaccabile dalla corrosione sia di agenti atmosferici che di fertilizzanti chimici, colori stabilizzati da trattamento U.V., resistente a sbalzi termici da -60° C a + 90° C.

LED Lampadine LED GX53 3W incluse.
CCT regolabile: 3000 K, 4000 K, 6500 K.



096575	096599	096582
0,400 Kg / 0,0025 m³ GX53 max 1x10W	0,400 Kg / 0,0025 m³ GX53 max 1x10W	0,400 Kg / 0,0025 m³ GX53 max 1x10W
€ 37	€ 37	€ 37
096544 Bianco 096568 Grigio 096551 Nero	096575 Bianco 096599 Grigio 096582 Nero	096575 Bianco 096599 Grigio 096582 Nero
4000 K 1000 lm	4000 K 1000 lm	4000 K 1000 lm
154008 € 6,00	154008 € 6,00	154008 € 6,00



Taurus

Spot multi-orientabile da incasso per installazione a pavimento, parete o controsoffitto. Corpo in alluminio pressofuso, ghiera in acciaio inox 316L, diffusore in vetro trasparente. Sorgente luminosa a led integrato, disponibile nelle versioni con 1, 2 o 3 moduli LED singolarmente orientabili di +/- 30° mediante perno esterno per ampliare, restringere o direzionare il fascio luminoso complessivo. Calpestabile, indice di protezione IP67, resistenza all'urto IK09/IK10, temperatura di colore 3000K.

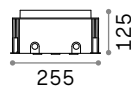
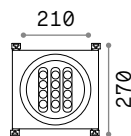

4,400 Kg / 0,0242 m³
LED 20W / 1950 Lm

€ 530

277035 ■ Acciaio

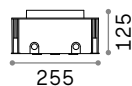
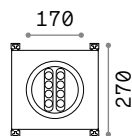

3,250 Kg / 0,0133 m³
LED 13,5W / 1300 Lm

€ 405

277028 ■ Acciaio

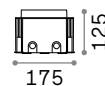
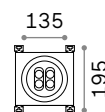

1,980 Kg / 0,0071 m³
LED 10W / 860 Lm

€ 320

277011 ■ Acciaio

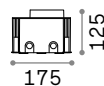
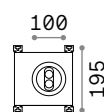

1,460 Kg / 0,0129 m³
LED 5,5W / 430 Lm

€ 210

277004 ■ Acciaio



Sorgente luminosa LED 3000 K,
50.000 h di durata.



Floor

Incasso fisso da esterni in alluminio pressofuso con ghiera rotonda disponibile in tre dimensioni, adatto per installazione a terra e a pavimento. Finitura in alluminio anodizzato con diffusore in vetro temprato extrachiaro. LED integrati raffreddati passivamente con ottica di 30°; disponibile in temperatura di colore 3000 K e CRI \geq 80; grado di protezione IP 67; IK 10.



Sorgente luminosa LED 3000 K,
25.000 h di durata.

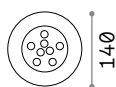

140

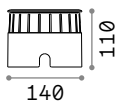

110



0,960 Kg / 0,0049 m³
LED 12W / 1340 Lm

€ 106

255682 ■ Acciaio

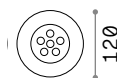

120

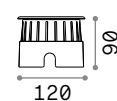

90



0,640 Kg / 0,0015 m³
LED 6W / 680 Lm

€ 73

255668 ■ Acciaio



90

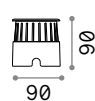

90



0,390 Kg / 0,0010 m³
LED 3W / 310 Lm









€ 55

255651 ■ Acciaio

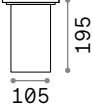
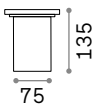
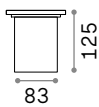

Park

Spot da incasso. Corpo luce esterno in PVC. Parabola riflettente in alluminio. Cornice blocca vetro in acciaio satinato. Vetro trasparente.

		
		
 IP54	 IP67	 IP54
1,210 Kg / 0,0066 m ³ E27 max 1x60W	0,580 Kg / 0,0032 m ³ GU10 max 1x20W	0,900 Kg / 0,0032 m ³ G9 max 1x15W
€ 80	€ 57	€ 80
032825 ■ Acciaio	032832 ■ Acciaio	117881 ■ Acciaio
 4000 K 980 lm	 4000 K 500 lm	 4000 K 390 lm
153964 € 7,00	253497 € 4,50	209036 € 3,90



Park Led

Diffusore in vetro temperato trasparente. Calpestabile. Sorgente luminosa a led integrato. Assenza di viti a vista.

LED Sorgente luminosa LED 4000 K, 50.000 h di durata.

IP68 Grado di protezione IP68.

S316 Articolo in acciaio inox 316.



1,270 Kg / 0,0018 m³
LED 4,8W / 600 lm

€ 220

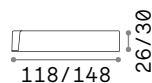

Driver
Non incluso
Necessario

€ 65/70

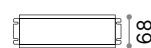
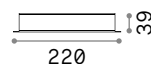

Driver
Non incluso
Necessario

€ 190/210

222868	■ Acciaio	15°	226187	20W
222875	■ Acciaio	60°	226194	35W

226200	100W
226217	185W



Gravity

Corpo luce e diffusore in resina ad alte prestazioni: inattaccabile dalla corrosione sia di agenti atmosferici che di fertilizzanti chimici, colori stabilizzati da trattamento U.V., resistente a sbalzi termici da -60° C a + 90° C. Carrabile fino a 5000 Kg.

LED Lampadine LED GU10 3,5W e LED GX53 10W incluse. CCT regolabile.

0,670 Kg / 0,0043 m³ GX53 max 1x 10W	0,270 Kg / 0,0019 m³ GU10 max 1x 6W	0,700 Kg / 0,0044 m³ GX53 max 1x 10W	0,270 Kg / 0,0019 m³ GU10 max 1x 6W
€ 85	€ 58	€ 85	€ 58
120324 ■ Nero	120249 ■ Nero	120386 ■ Nero	120317 ■ Nero
4000 K 1000 lm	4000 K 500 lm	4000 K 1000 lm	4000 K 500 lm
154008 € 6,00	253497 € 4,50	154008 € 6,00	253497 € 4,50



Landing

Corpo luce e diffusore in resina ad alte prestazioni: inattaccabile dalla corrosione sia di agenti atmosferici che di fertilizzanti chimici, colori stabilizzati da trattamento U.V., resistente a sbalzi termici da -60° C a + 90° C. Carrabile fino a 5000 Kg.

LED

Lampadine LED GU10 3,5W e LED GX53 10W incluse. CCT regolabile.



120362



120287

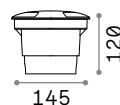

0,740 Kg / 0,0043 m³
GX53 max 1x10W

€ 125

120362 ■ Nero

4000 K
1000 lm

154008

€ 6,00

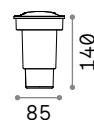

0,260 Kg / 0,0020 m³
GU10 max 1x6W

€ 85

120287 ■ Nero

4000 K
500 lm

253497

€ 4,50



Rocket Mini

Diffusore in vetro temperato trasparente. Calpestabile. Sorgente luminosa a led integrato. Assenza di viti a vista. Disponibile nelle versioni a 1, 2 luci in radenza pavimento oppure con unica luce centrale d'accento.

LED

Sorgente luminosa LED 4000 K, 50.000 h di durata.

IP68

Grado di protezione IP68.

S316

Articolo in acciaio inox 316.

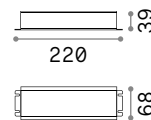
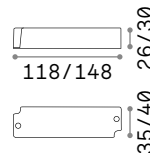
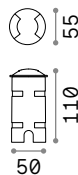
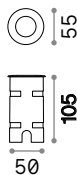

0,280 Kg / 0,0008 m³
LED 2W / 210 lm

€ 100

212623 ■ Acciaio 15°
212647 ■ Acciaio 40°



0,330 Kg / 0,0008 m³
LED 2W / 210 lm

€ 130 / 150

222820 ■ Acciaio
222837 ■ Acciaio

Driver
Non incluso
Necessario

€ 65 / 70

226187 20W
226194 35W

Driver
Non incluso
Necessario

€ 190 / 210

226200 100W
226217 185W

Rocket

Apparecchio da incasso calpestabile. Corpo luce in acciaio spazzolato. Diffusore in vetro temperato.

LED Sorgente luminosa LED 3000/4000 K, 30.000 h di durata.

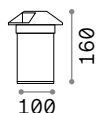
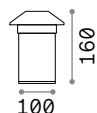

IP65

IP65

0,560 Kg / 0,0034 m³
LED 3,5W / 230/270 lm

0,560 Kg / 0,0034 m³
LED 3,5W / 230/270 lm

€ 135

€ 135

247144 ■ Acciaio 3000K 247151 ■ Acciaio 3000K
122014 ■ Acciaio 4000K 122021 ■ Acciaio 4000K



Way

Apparecchio da incasso calpestabile. Corpo luce e diffusore in resina ad alte prestazioni: anti corrosione, anti U.V., da -60°a +90° C. Colore: nero.

LED Lampadine LED G9 2W 3000/4000 K incluse. Cod. 270104/270111

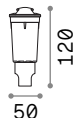
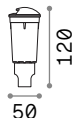
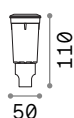

IP67

IP67

IP67

0,100 Kg / 0,0007 m³
G9 max 1x1,7W

0,080 Kg / 0,0007 m³
G9 max 1x1,7W

0,080 Kg / 0,0007 m³
G9 max 1x1,7W

€ 31

€ 31

€ 31

269726 ■ N 3000K
269733 ■ N 4000K

269504 ■ N 3000K
269696 ■ N 4000K

269702 ■ N 3000K
269719 ■ N 4000K

270104 3000K
€ 8,90
270111 4000K
€ 8,90

270104 3000K
€ 8,90
270111 4000K
€ 8,90

270104 3000K
€ 8,90
270111 4000K
€ 8,90





Lampadine* e accessori



new



E14 846

E27 848



new



G4 854

G9 854



new



R7s 855



new

GU10 856



new



Strip 858

Kit Emergency 859



new



new



Ceiling Cups 860

Bulb Holders 864

Cables 864

Cables Holders 864



* Per le lampadine e strip led al prezzo indicato non sono applicabili ulteriori promozioni.

Lampadine E14

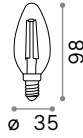

Lamp socket	Power	Flux	CCT	CRI	Dimmable	Life	Min Qty.	Code	€
E14	4W	450 lm	2700 K	80		25.000 h	10	270944	3,00
E14	4W	470 lm	3000 K	80		25.000 h	10	101224	3,00
E14	4W	320 lm	3000 K	80	TRIAC	15.000 h	10	188928	3,90
E14	4W	490 lm	4000 K	80		25.000 h	10	153933	3,00
E14	4W	430 lm	3000 K	90		25.000 h	10	271644	3,00

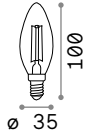

E14	4W	370 lm	2200 K	80		15.000 h	10	151649	5,50
-----	----	--------	--------	----	--	----------	----	--------	------

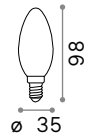

E14	4W	370 lm	3000 K	80		25.000 h	10	101231	3,00
-----	----	--------	--------	----	--	----------	----	--------	------

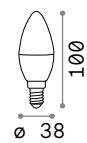

E14	6W	520 lm	3000 K	80		25.000 h	10	151748	3,00
E14	6W	520 lm	4000 K	80		25.000 h	10	151953	3,00



151663



151793



101224



151649



101231











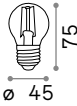



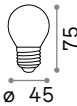

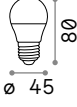

101200



101262

Lampadine E27

		Lamp socket	Power	Flux	CCT	CRI	Dimmable	Life	Min Qty.	Code	€
		E27	4 W	490 lm	2700 K	80		25.000 h	10	271637	3,00
		E27	4 W	430 lm	3000 K	80		25.000 h	10	101279	3,00
		E27	4 W	340 lm	3000 K	80	TRIAC	15.000 h	10	188942	3,00
		E27	4 W	490 lm	4000 K	80		25.000 h	10	153957	3,00
		E27	4 W	350 lm	3000 K	90		25.000 h	10	289236	3,00
		E27	4 W	380 lm	2200 K	80		15.000 h	10	151861	5,50
		E27	4 W	340 lm	3000 K	80		25.000 h	10	101286	3,00
		E27	6 W	600 lm	3000 K	80		25.000 h	10	151755	2,50
		E27	6 W	600 lm	4000 K	80		25.000 h	10	151960	2,50
		E27	4 W	480 lm	3000 K	80		25.000 h	10	101293	3,00
		E27	4 W	520 lm	4000 K	80		25.000 h	10	253428	3,00
		E27	8 W	930 lm	2700 K	80		25.000 h	10	270951	7,00
		E27	8 W	910 lm	3000 K	80		25.000 h	10	119571	7,00
		E27	8 W	680 lm	3000 K	80	TRIAC	15.000 h	10	188973	7,50
		E27	8 W	980 lm	4000 K	80		25.000 h	10	153964	7,00
		E27	8 W	880 lm	3000 K	90		25.000 h	10	271613	7,00
		E27	10 W	1300 lm	3000 K	80		25.000 h	10	256528	7,00
		E27	10 W	1380 lm	4000 K	80		25.000 h	10	270920	7,00
		E27	4 W	370 lm	2200 K	80		15.000 h	10	151687	5,50
		E27	8 W	900 lm	3000 K	80		25.000 h	10	123899	7,00
		E27	8 W	860 lm	3000 K	80	TRIAC	25.000 h	10	252209	7,50
		E27	8 W	1030 lm	4000 K	80		25.000 h	10	253459	7,00
		E27	8 W	780 lm	3000 K	90		25.000 h	10	289250	7,50
		E27	10 W	1000 lm	3000 K	80		25.000 h	10	151762	2,50
		E27	10 W	1000 lm	4000 K	80		25.000 h	10	151991	2,50
		E27	8 W	920 lm	3000 K	80		25.000 h	10	305622	7,50 new
		E27	10 W	1150 lm	3000 K	80		25.000 h	10	305639	7,00 new

Lampadine E27

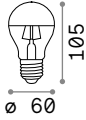

Lamp socket	Power	Flux	CCT	CRI	Dimmable	Life	Min Qty.	Code	€
E27	8 W	770 lm	3000 K	80		25.000 h	10	123882	7,50

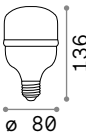

Lamp socket	Power	Flux	CCT	CRI	Dimmable	Life	Min Qty.	Code	€
E27	20 W	2000 lm	3000 K	80		25.000 h	1	296197	6,00 <i>new</i>
E27	20 W	2050 lm	4000 K	80		25.000 h	1	306889	6,00 <i>new</i>



E27	30 W	3100 lm	3000 K	80		25.000 h	1	296210	11,00 <i>new</i>
E27	30 W	3200 lm	4000 K	80		25.000 h	1	306896	11,00 <i>new</i>



296197



296210



101279



151861









101293



123882

Lampadine E27

	Lamp socket	Power	Flux	CCT	CRI	Dimmable	Life	Min Qty.	Code	€
	E27	8 W	1120 lm	3000 K	80		25.000 h	10	101323	7,50
	E27	8 W	680 lm	3000 K	80	TRIAC	15.000 h	10	188966	8,50
	E27	8 W	1120 lm	4000 K	80		25.000 h	10	153971	7,50
	E27	8 W	860 lm	3000 K	90		25.000 h	10	271606	7,50
	E27	4 W	500 lm	2200 K	80		15.000 h	10	151717	8,90
	E27	4 W	330 lm	2200 K	80	TRIAC	15.000 h	10	223933	7,50
	E27	8 W	950 lm	3000 K	80		25.000 h	10	101330	8,00
	E27	8 W	860 lm	3000 K	80	TRIAC	25.000 h	10	252186	8,50
	E27	8 W	1050 lm	4000 K	80		25.000 h	10	253442	8,00
	E27	8 W	770 lm	3000 K	90		25.000 h	10	289243	8,00
	E27	15 W	1820 lm	3000 K	80		25.000 h	10	151779	5,50
	E27	15 W	1820 lm	4000 K	80		25.000 h	10	151977	5,50
	E27	8 W	900 lm	3000 K	80	TRIAC	15.000 h	10	277790	10,50 <i>new</i>
	E27	8 W	1050 lm	3000 K	80		25.000 h	10	157597	10,50
	E27	9 W	930 lm	3000 K	80		25.000 h	10	135526	10,50

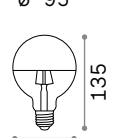
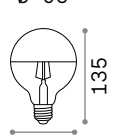
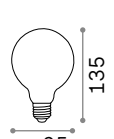
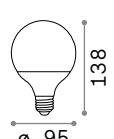
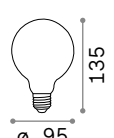
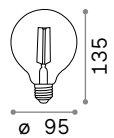
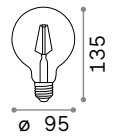

101330



157597



135526

Lampadine E27

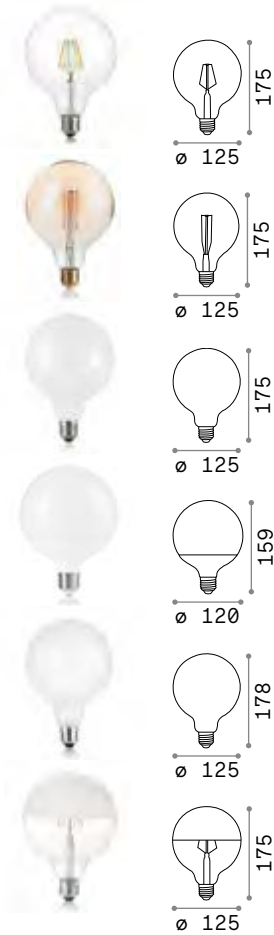

Lamp socket	Power	Flux	CCT	CRI	Dimmable	Life	Min Qty.	Code	€
E27	8 W	1020lm	3000 K	80		25.000 h	10	101347	8,50
E27	8 W	680 lm	3000 K	80	TRIAC	15.000 h	10	188959	9,00
E27	8 W	1070 lm	4000 K	80		25.000 h	10	153988	8,50
E27	8 W	860 lm	3000 K	90		25.000 h	10	271590	8,50
E27	4 W	480 lm	2200 K	80		15.000 h	10	151724	8,50
E27	4 W	330 lm	2200 K	80	TRIAC	15.000 h	10	223926	9,50
E27	8 W	900 lm	3000 K	80		25.000 h	10	101354	8,50
E27	8 W	1030 lm	4000 K	80		25.000 h	10	253435	8,50
E27	18 W	2180 lm	3000 K	80		25.000 h	10	151786	8,00
E27	18 W	2180 lm	4000 K	80		25.000 h	10	152004	8,00
E27	8 W	900 lm	3000 K	80	TRIAC	15.000 h	10	277813	11,00 <i>new</i>
E27	8 W	1050 lm	3000 K	80		25.000 h	10	157580	11,00



101347











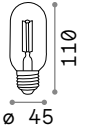

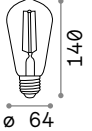

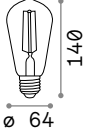
151724

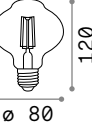

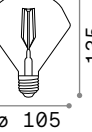

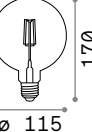

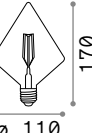
277813

Lampadine E27

		Lamp socket	Power	Flux	CCT	CRI	Dimmable	Life	Min Qty.	Code	€
		E27	4 W	330 lm	2200 K	80		15.000 h	10	151700	5,50
		E27	4 W	440 lm	2200 K	80		15.000 h	10	151694	7,00
		E27	4 W	330 lm	2200 K	80	TRIAC	15.000 h	10	223919	7,00
		E27	4 W	340 lm	1800 K	80		15.000 h	10	201283	5,90
		E27	4 W	340 lm	1800 K	80		15.000 h	10	201269	11,00
		E27	4 W	340 lm	1800 K	80		15.000 h	10	201290	12,50
		E27	4 W	340 lm	1800 K	80		15.000 h	10	201276	12,50

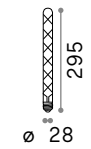
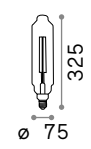
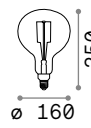
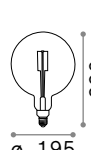
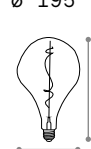

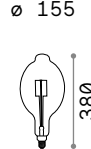
Lampadine E27

	Lamp socket	Power	Flux	CCT	CRI	Dimmable	Life	Min Qty.	Code	€
										
	E27	6 W	500 lm	1800 K	80		15.000 h	10	201252	11,00
	E27	4 W	320 lm	2200 K	80		15.000 h	1	130170	35,00
	E27	4 W	320 lm	2200 K	80		15.000 h	1	129877	30,00
	E27	4 W	330 lm	2200 K	80	TRIAC	15.000 h	1	223940	30,00
	E27	4 W	400 lm	2200 K	80		25.000 h	1	130187	30,00
	E27	4 W	330 lm	2200 K	80	TRIAC	15.000 h	1	223834	35,00
	E27	4 W	360 lm	2200 K	80		25.000 h	1	237251	25,00
	E27	8 W	700 lm	2200 K	80		25.000 h	1	130163	30,00
	E27	4 W	320 lm	2200 K	80		15.000 h	1	129860	35,00



201252 130170 129877 130187 237251 130163 129860

Lampadine G4

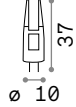
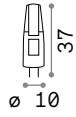

Lamp socket	Power	Flux	CCT	CRI	Dimmable	Life	Min Qty.	Code	€
G4	1,5W	160 lm	3000 K	80		15.000 h	20	188980	6,00
G4	1,5W	150 lm	3000 K	90		15.000 h	20	288345	6,00
G4	2W	160 lm	3000 K	80		20.000 h	20	222257	4,50
G4	2W	180 lm	3000 K	80	Phase-cut	25.000 h	20	266282	6,90

Lampadine G9

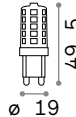
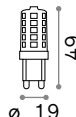
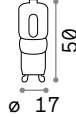

Lamp socket	Power	Flux	CCT	CRI	Dimmable	Life	Min Qty.	Code	€
G9	2W	150 lm	3000 K	80		25.000 h	20	270104	8,90
G9	2W	150 lm	4000 K	80		25.000 h	20	270111	8,90
G9	2,5W	200 lm	3000 K	80		20.000 h	20	122168	3,00
G9	2,5W	210 lm	4000 K	80		20.000 h	20	253381	3,00
G9	3W	350 lm	2700 K	80		15.000 h	20	270968	3,90
G9	3W	370 lm	3000 K	80		15.000 h	20	209043	3,90
G9	3W	260 lm	3000 K	80	TRIAC	25.000 h	20	288215	5,50
G9	3W	390 lm	4000 K	80		15.000 h	20	209036	3,90
G9	3,5W	310 lm	3000 K	90		15.000 h	20	288208	3,90
G9	3,5W	510 lm	3000 K	80		15.000 h	20	305486	6,00 new
G9	3,5W	420 lm	3000 K	80	TRIAC	15.000 h	20	305431	8,50 new
G9	4W	530 lm	4000 K	80		15.000 h	20	307879	6,00 new
G9	4W	440 lm	4000 K	80	TRIAC	15.000 h	20	307886	8,50 new

Lampadine GX53

101385

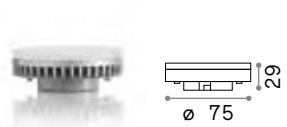

Lamp socket	Power	Flux	CCT	CRI	Dimmable	Life	Min Qty.	Code	€
GX53	7W	600lm	3000K	80		25.000 h	10	101385	6,70
GX53	7W	610lm	4000K	80		25.000 h	10	253404	6,70
GX53	9W	910lm	3000K	80		25.000 h	10	123936	6,00
GX53	9W	890lm	3000K	80	TRIAC	25.000 h	10	252551	9,50
GX53	9W	1000lm	4000K	80		25.000 h	10	154008	6,00
GX53	9W	900lm	4000K	80	TRIAC	25.000 h	10	252568	9,50
GX53	9W	940lm	3000K	90		25.000 h	10	288383	6,00





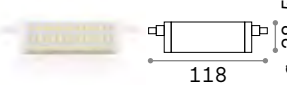
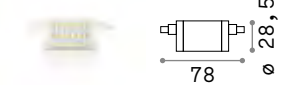

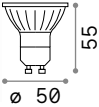

Lampadine R7s

189109

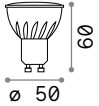

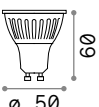
Lamp socket	Power	Flux	CCT	CRI	Dimmable	Life	Min Qty.	Code	€
R7s	7W	560lm	3000K	80		20.000 h	10	189109	14,50
R7s	6W	450lm	3000K	80	TRIAC	20.000 h	10	266770	15,50
R7s	7W	580lm	4000K	80		20.000 h	10	272375	14,50
R7s	6W	480lm	4000K	80	TRIAC	20.000 h	10	272382	15,50
R7s	13W	760lm	3000K	80		20.000 h	10	189093	18,50
R7s	8W	580lm	3000K	80	TRIAC	20.000 h	10	266763	20,00
R7s	13W	830lm	4000K	80		20.000 h	10	253480	18,50
R7s	8W	640lm	4000K	80	TRIAC	20.000 h	10	266756	20,00
R7s	8W	1000lm	3000K	80		15.000 h	10	299310	11,50 <i>new</i>
R7s	8W	850lm	3000K	80	TRIAC	15.000 h	10	299303	12,50 <i>new</i>
R7s	8W	1000lm	4000K	80		15.000 h	10	307633	11,50 <i>new</i>
R7s	8W	900lm	4000K	80	TRIAC	15.000 h	10	307640	12,50 <i>new</i>
R7s	14W	1700lm	3000K	80		15.000 h	10	307862	13,50 <i>new</i>
R7s	14W	1600lm	3000K	80	TRIAC	15.000 h	10	307855	15,00 <i>new</i>
R7s	14W	1700lm	4000K	80		15.000 h	10	296869	13,50 <i>new</i>
R7s	14W	1650lm	4000K	80	TRIAC	15.000 h	10	296876	15,00 <i>new</i>

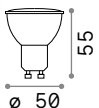
Lampadine GU10

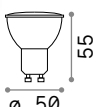
	Lamp socket	Power	Flux	CCT	CRI	Beam	Dimm.	Life	Min Qty.	Code	€	
		GU10	5W	440 lm	3000 K	90	47°	25.000 h	10	108292	4,50	
		GU10	5W	390 lm	3000 K	90	47°	TRIAC	25.000 h	10	266251	4,50
		GU10	5W	500 lm	4000 K	90	47°		25.000 h	10	253497	4,50
		GU10	5W	420 lm	4000 K	90	47°	TRIAC	25.000 h	10	285566	4,50
		GU10	7W	610 lm	3000 K	90	50°		25.000 h	10	123943	4,50
		GU10	7W	540 lm	3000 K	90	50°	TRIAC	25.000 h	10	288239	5,90
		GU10	7W	700 lm	4000 K	90	50°		25.000 h	10	224367	4,50
		GU10	7W	530 lm	3000 K	90	50°		25.000 h	10	288222	9,00
		GU10	7W	690 lm	3000 K	90	108°	25.000 h	10	101378	9,00	
		GU10	7W	770 lm	4000 K	90	108°		30.000 h	10	117652	9,00
			GU10	8W	760 lm	3000 K	90	54°	25.000 h	10	189062	9,00
		GU10	8W	880 lm	4000 K	90	54°		25.000 h	10	270975	9,00
			GU10	5W	380 lm	2700 K	95	47°	25.000 h	10	307619	4,50 new
			GU10	7W	600 lm	2700 K	95	107°	25.000 h	10	307626	4,50 new
			GU10	7W	600 lm	2700 K	95	107°	25.000 h	10	307626	4,50 new
			GU10	7W	600 lm	2700 K	95	107°	25.000 h	10	307626	4,50 new



108292



101378



189062

Lampadine GU10

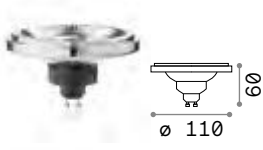
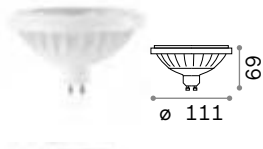
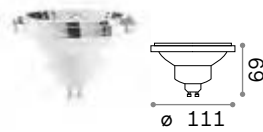
	Lamp socket	Power	Flux	CCT	CRI	Beam	Dimm.	Life	Min Qty.	Code	€
	GU10	12 W	960 lm	3000 K	80	23°		25.000 h	10	242040	14,50
	GU10	12 W	900 lm	3000 K	80	23°	TRIAC	25.000 h	10	266305	16,00
	GU10	12 W	1190 lm	4000 K	80	23°		25.000 h	10	285573	14,50
	GU10	12 W	1120 lm	3000 K	80	46°		25.000 h	10	183794	14,50
	GU10	12 W	1240 lm	4000 K	80	46°		25.000 h	10	253466	14,50
	GU10	13 W	1300 lm	3000 K	80	46°	TRIAC	25.000 h	10	266299	18,50
	GU10	10 W	800 lm	3000 K	80	20°		15.000 h	10	189031	15,00
	GU10	10 W	820 lm	4000 K	80	20°		15.000 h	10	253398	15,00
	GU10	10 W	800 lm	3000 K	80	24°	TRIAC	15.000 h	10	288543	19,00



242040



183794



189031

Strip LED and Drivers

Volt 24 Vdc
 MacAdam SDCM 3
 Beam 120°
 LED life 35.000 h

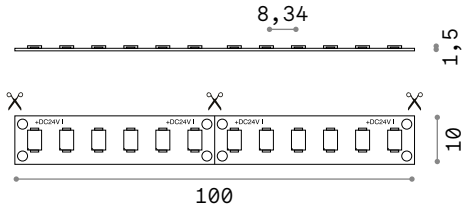

SMD 2835 120 LED/m CRI ≥90

Power	IP	Flux	CCT	Length	Code	€
15 W/m	IP20	1400 lm/m	2700 K	5000 mm	272498	50
		1450 lm/m	3000 K	5000 mm	272481	50
		1600 lm/m	4000 K	5000 mm	272474	50
	IP65	1400 lm/m	3000 K	5000 mm	272504	65
		1480 lm/m	4000 K	5000 mm	287959	65

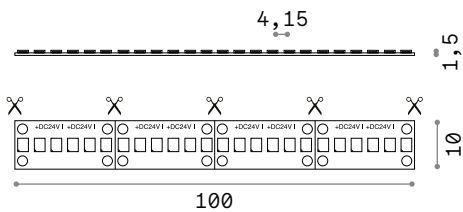

SMD 2835 240 LED/m CRI ≥90

Power	IP	Flux	CCT	Length	Code	€
20,5 W/m	IP20	2000 lm/m	2700 K	5000 mm	272535	80
		2050 lm/m	3000 K	5000 mm	272528	80
		2100 lm/m	4000 K	5000 mm	272511	80
	IP65	2000 lm/m	3000 K	5000 mm	272542	90
		2020 lm/m	4000 K	5000 mm	287966	90

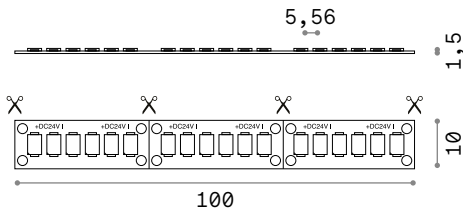

SMD 2835 180 LED/m CRI ≥90

Power	IP	Flux	CCT	Length	Code	€
40 W/m	IP20	3370 lm/m	3000 K	3000 mm	253886	120
		3730 lm/m	4000 K	3000 mm	253893	120

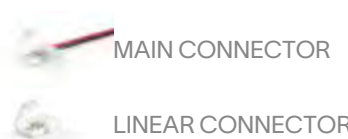

Required	Code	€
No - Optional	292939	1 new
No - Optional	292953	1 new



Solo per installazione in interni



Driver	Power	Output	Class	Measure (LxHxW)	Code	€
On-Off	30 W	24 Vdc	□	140 x 28 x 45 mm	124070	17,50
	60 W	24 Vdc	□	186 x 33 x 50 mm	124087	30
	150 W	24 Vdc	⊕	268 x 31 x 45 mm	124117	50
1-10V/Push	36 W	24 Vdc	□	293 x 30 x 43 mm	244556	60
	75 W	24 Vdc	⊕	293 x 30 x 43 mm	244570	100
	150 W	24 Vdc	⊕	352 x 30 x 43 mm	244594	140
DALI/Push	36 W	24 Vdc	□	175 x 30 x 44 mm	244549	75
	75 W	24 Vdc	⊕	295 x 30 x 43 mm	244563	115
	150 W	24 Vdc	⊕	273 x 37 x 57 mm	244587	150

Kit emergency

Kit luce d'emergenza per moduli LED. Include inverter e batteria. Autonomia da due a tre ore con un tempo di ricarica rispettivamente di 12 e 24 ore. Funzionamento in sola emergenza o in luce continua (luce continua in abbinamento con alimentatori elettronici e alimentatori elettronici dimmerabili). Protetto in classe II.

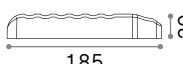
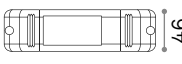
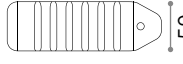

INVERTER	GROUP BATTERY
	
	
IP20	
0,185 Kg / 0,0009 m ³	0,305 Kg / 0,0010 m ³
Ⓜ 52 mm	Ⓜ 65 mm

€ 120

221595 Bianco

Per ulteriori informazioni, si prega di contattare l'ufficio tecnico.

Rosoni

Rosoni magnetici

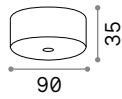

1 cavo



244235 € 16,00 244259 € 16,00 249315 € 19,00 249308 € 19,00 244242 € 16,00

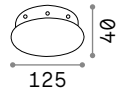

6 cavi



303390 € 25,00^{new} 303406 € 25,00^{new} 307091 € 35,00^{new} 307084 € 35,00^{new} 307077 € 25,00^{new}

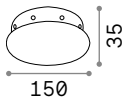

8 cavi



272429 € 30,00 272436 € 30,00 272443 € 41,00 272450 € 41,00 272467 € 30,00

Rosoni incasso

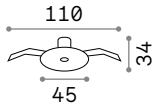

1 cavo



301594 € 5,00^{new} 307107 € 5,00^{new} 307138 € 5,00^{new} 307121 € 5,00^{new} 307114 € 5,00^{new}

Rosoni

Rosoni standard

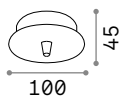

1 cavo



122823 € 8,00 122830 € 8,00 249278 € 9,00 249261 € 9,00 123295 € 8,00

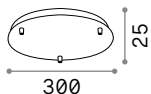

3 cavi



285580 € 50,00 285597 € 50,00 285627 € 72,00 285610 € 72,00 285603 € 50,00

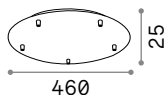

5 cavi



285634 € 83,00 285641 € 83,00 285672 € 110,00 285665 € 110,00 285658 € 83,00

Rosoni lineari

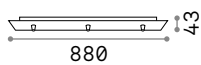

3 cavi



122854 € 39,00 122861 € 39,00 249292 € 44,00 249285 € 44,00 123301 € 39,00

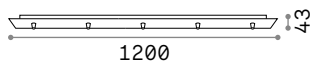

5 cavi



285689 € 61,00 285696 € 61,00 285726 € 77,00 285719 € 77,00 285702 € 61,00

Rosoni

Rosoni all in

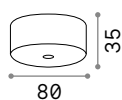

3 cavi

				
285733 € 28,00	285740 € 28,00	285771 € 33,00	285764 € 33,00	285757 € 28,00

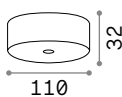

6 cavi

				
285788 € 33,00	285795 € 33,00	285825 € 44,00	285818 € 44,00	285801 € 33,00

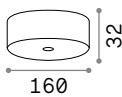

12 cavi

				
285832 € 50,00	285849 € 50,00	285870 € 60,00	285863 € 60,00	285856 € 50,00



Accessori

Portalampada

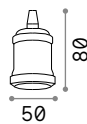

249186 € 15,00 249193 € 15,00 249223 € 15,00 249216 € 15,00 249209 € 15,00



242569 € 7,50 249230 € 7,50 249254 € 7,50 249247 € 7,50 242576 € 7,50

Cavi

Ø5x5000 mm
2x0,75 mm²
FEPT180°
PVC T90°
*only PVC



301624 € 16,00^{new} 301662* € 16,00^{new} 301655 € 16,00^{new} 301648 € 16,00^{new} 301631 € 16,00^{new}

Ø5x10000 mm
2x0,75 mm²
FEPT180°
PVC T90°
*only PVC



301679 € 25,00^{new} 301716* € 25,00^{new} 301709 € 25,00^{new} 301693 € 25,00^{new} 301686 € 25,00^{new}

Ø5x10000 mm
2x0,75 mm²
FEPT180°
PVC T90°



303062 € 30,00^{new} 306421 € 30,00^{new} 303093 € 30,00^{new} 303086 € 30,00^{new} 303079 € 30,00^{new}

Supporti



143200 € 7,00 143224 € 7,00 249339 € 7,00 249322 € 7,00 143217 € 7,00



285887 € 7,00 285894 € 7,00 285924 € 7,00 285917 € 7,00 285900 € 7,00



Angolo

Pag 496



Indice famiglie



Alfa ■ 314 ■ 314 ■ 407 ■ 407



Angolo ■ 326 ■ 467 ■ 496



Arizona ■ 154 ■ 154 ■ 284 ■ 284 ■ 284



Axel ■ 470 ■ 517



Birds ■ 094 ■ 319 ■ 413 ■ 466 ■ 492































































Bubble ■ 730 ■ 768



Caesar ■ 209 ■ 209 ■ 209 ■ 341 ■ 341

Indice famiglie

Interno, esterno

					
Calypso	 196	 196	 432		
					
Candy	 155	 155	 285	 460	
					
Cantina	 129	 418			
					
Carlton	 202	 202	 343	 343	 433
					
Chalet	 242	 242	 242	 438	 480
					
Cima	 770	 814			
					
Clio	 724	 724	 769	 812	 812
					
Corte	 228	 228	 228	 435	



Craft

083

364

364

502



Cylinder

189

524



Dafne

771

771

815



Desk

082

364



Diesis

117

453

503



Driftwood

243

243

478

478

518



Dubai

208

208

341

341

341

433



Dynamite

088

088

306

Indice famiglie

Interno, esterno



Edison

111

408



Elio

738

824



Equinox

098

098

098

098

098

417



495



Essence

080

382

382



Etere

747

806



Filo

078

078

352



Firenze

238

238

438

481

531





























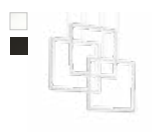
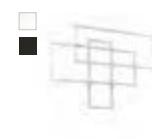

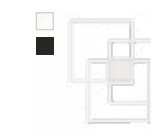
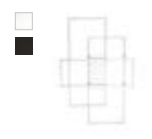









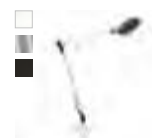

























Florian

222

222

222

436

							
Fly	 070	 070	 070	 070	 260	 260	
							
	 260	 260					
							
Frame	 068	 068	 068	 256	 256	 256	
							
Frida	 110	 411	Futura			 454	 507
							
Gas	 740	 796					
							
Gioconda	 226	 226	 226	 437			
							
Glim	 313	 313	 313	 640			
							
Glory	 153	 153	 153	 282	 282	 282	

Indice famiglie

Interno, esterno

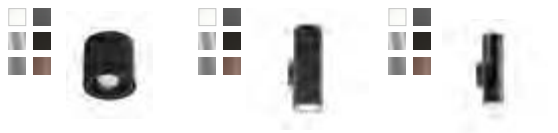

Gun

727

752

752



Halo

072

072

072

270

270

270



Harem

241

241

440



Hilton

191

191

191

426

473

473



527



Igor

093

093

093

412



Kepler

101

101

414



King

196

196

334

334

334



Konig

312 312 312 640



Lana

150 294 294



Lika

305 706 706 706 708 708



708



Lingotto

092 092 092 327 327 327



469 469



Linus

365 572



Litio

739 825













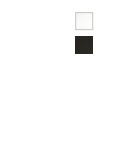



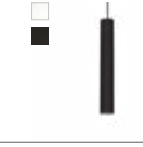

















London

188 471 471 521

Indice famiglie

Interno, esterno

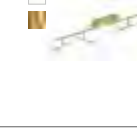
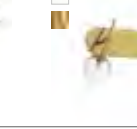
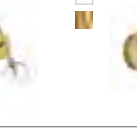
Look						
	074	074	298	298	298	298
						
	371	641				
Luna						
	723	723	784	784	784	
Luxury						
	428	472	525			
Mapa Bianco						
	162	162	162	162	162	284
						
	374	374	374	461	461	461
Mapa Max						
	159	159	159	462		
Maracas						
	315	315	416	416		



Martinez ■ 201 ■ 201 ■ 342



Microphone ■ 468 ■ 501



Minimal ■ 112 ■ 112 ■ 410 ■ 500



Mix Up ■ 120 ■ 288



Mouse ■ 310 ■ 404 ■ 404 ■ 638



Multiflex ■ 175 ■ 322



Negresco ■ 218 ■ 218 ■ 436



Newton ■ 418 ■ 504

Indice famiglie

Interno, esterno



Ninfea

329

329

421



Nodi

171

171

316



Nordik

188

188

428

472

524



Oak

076

076

304

304



Oby

311

311

406

406



Opera

194

194

194

434

483

529



Oracle Slim

062

062

062

062

062

062



062

254

254

254



Ovalino

172

172

286

286

372



Oz

060

060

259

350

448



Pan

089

420



Pashà

205

205

205

333

333

333



432



Pauline

102

321



Pegaso

212

212

212

212

435

487



487

530

Indice famiglie

Interno, esterno

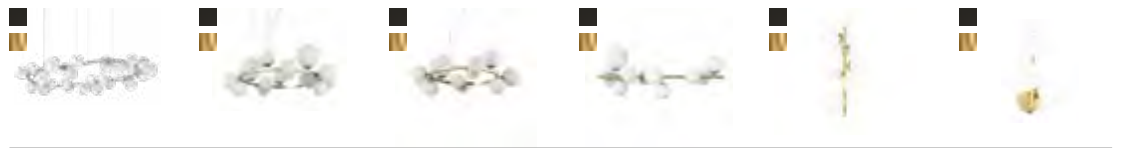

Perlage

096

096

096

096

096

415



415

466

466

494



Play

307

698



Queen

486

486

486

530



Rain

199

339

339

482



Roma

203

203

332

332

332

332



432

482



Rudy

311

311

405

405



Sally

457

509



Set Up

192

290

424

424

476

476



522



Sky

077

299

299

299

370



Slem

314

407

407



Smarties

152

152

152

283

283

283



283

375

460



Sole

722

722

722

783

783

783

Indice famiglie

Interno, esterno



Spark

101

324



Spot

310

404

404

638



Strauss

230

230

230

437



Style

744

744

789



Swan

195

195

434



Terra

740

740

826

826



Triumph

090

318

416

416

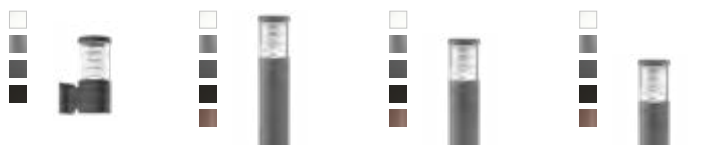

Tronco

746

802

802

802



Wally

457

508



Wheel

190

190

293

293



Winery

309

408



Woody

190

190

292

292

427



Xeno

728

741



Yoko

081

452

498



Indice per codice

deal lux



Indice per codice

SKU	Pag	009957	358	025315	128	034706	219	045627	384	061597	761
		010861	281	025438	189	034713	219	045634	384	062273	515
000206	461	012865	238	026473	376	034720	219	046167	740	066387	197
000251	463	012872	238	026480	376	035185	357	046181	740	066431	212
000268	463	012889	481	026558	377	035574	214	046211	826	066448	212
000619	443	012902	438	026787	134	035581	214	046471	512	066592	151
000657	332	012919	137	026954	802	035604	222	046723	512	066608	151
001197	505	013046	441	026961	802	035611	222	049229	359	066868	761
001814	145	013060	441	026978	746	035628	222	049236	359	068138	294
001821	145	013244	137	026985	802	035635	222	051406	485	068145	294
002408	227	013657	459	026992	802	035642	436	051444	361	068169	150
002880	531	014166	359	027005	746	035659	436	051741	515	068183	236
003399	215	014395	227	027081	380	035666	139	051765	515	068190	236
003528	504	014609	520	027098	380	035680	139	051840	379	068268	434
004099	231	014623	442	027104	380	035697	139	051857	379	068275	529
004716	746	014630	442	027357	130	035703	139	051864	379	068299	194
004723	802	014814	375	027364	130	035710	139	051963	358	068305	483
004730	802	015286	504	027418	221	035727	151	051970	358	071015	148
005294	378	016399	418	027821	221	035826	195	051987	358	071022	148
005386	388	016863	184	027852	418	035840	195	052359	131	073187	334
005454	378	016931	144	027876	418	035864	434	052366	131	073255	334
005881	228	017297	389	028460	435	035949	429	052373	131	073262	334
005898	228	017303	389	030326	134	035956	429	052786	151	073408	486
005911	246	017310	389	030784	336	035987	474	052793	168	073422	486
006321	314	017327	391	031361	359	036007	474	052809	168	073439	486
006338	314	017334	391	031460	395	036014	293	052816	168	073521	404
007021	388	017440	132	031477	395	036021	293	052991	338	073545	404
007045	388	017518	361	031507	391	038025	372	053004	338	073569	404
007960	294	018508	281	031743	185	041742	512	053448	133	073583	310
007977	294	018515	755	031750	185	041827	209	057187	228	073712	316
007984	294	018522	755	031996	152	042794	505	057194	228	074139	172
007991	294	018775	443	032009	152	043562	162	057200	435	074245	135
008356	482	018829	407	032016	152	044163	432	059181	197	074313	135
008363	199	018836	407	032023	283	044187	196	059211	435	074337	135
008370	339	018850	314	032030	283	044200	196	059228	530	074344	135
008455	339	019499	207	032047	283	044255	232	059235	212	074702	464
008608	295	019734	153	032078	460	044279	277	059242	212	074726	464
008615	295	019741	153	032122	162	044286	277	059259	487	074740	320
008622	295	019758	282	032139	162	044293	277	059266	487	074900	430
008851	391	019765	282	032351	188	044422	233	059679	148	075150	222
009087	162	020228	740	032368	471	044453	233	059808	374	075181	222
009131	461	020556	207	032375	471	044491	485	059815	374	075211	439
009148	162	020822	238	032382	521	044590	465	059822	374	075389	334
009155	461	020839	238	032436	474	044606	465	059839	284	075402	334
009223	283	020846	438	032467	474	044767	207	060491	437	075419	334
009360	112	020853	481	032504	221	044774	207	060507	226	075471	426
009377	407	020877	531	032825	838	044910	437	060514	226	075488	527
009391	112	022222	336	032832	838	044927	226	060620	372	075495	191
009407	112	022239	336	033013	752	044934	226	061115	510	075501	191
009483	407	023021	133	033020	752	045030	459	061122	510	075518	191
009513	357	023038	133	033037	826	045047	459	061139	510	075525	473
009537	357	024097	814	033044	826	045115	159	061160	457	075532	473
009681	190	024134	770	033532	209	045122	159	061191	457	077734	486
009698	190	025032	215	033662	158	045139	462	061450	748	077741	486
009704	231	025278	128	033679	158	045191	410	061467	748	077758	486
009933	358	025285	128	033952	133	045207	410	061474	748	077765	530
009940	358	025308	128	034546	356	045214	410	061580	761	077796	337

077802	337	087979	196	094649	337	101194	336	110424	114	114811	103
077819	337	088013	196	094663	337	101200	846	110431	114	115061	790
080291	335	088020	196	094687	336	101217	846	110448	471	115078	790
080338	335	088266	359	094786	246	101224	846	110455	471	115085	790
080345	335	088273	359	095226	154	101231	846	110462	114	115092	790
080352	335	089485	338	095264	369	101248	846	110530	471	115108	790
080932	337	089669	131	095288	369	101255	846	110554	471	115115	790
081434	277	089805	519	095615	232	101262	846	110745	138	115290	756
081441	277	090481	172	095998	371	101279	848	110752	138	115306	756
081502	216	090863	292	096018	371	101286	848	111117	321	115313	756
081519	216	090900	292	096162	173	101293	848	111452	524	115320	756
081526	216	091006	277	096476	738	101323	848	111841	176	115337	756
081540	216	091013	277	096483	738	101330	848	111858	176	115344	756
081557	216	091112	159	096544	835	101347	848	111865	176	115351	760
081564	216	091129	359	096551	835	101354	848	111872	214	115368	760
081762	158	091136	359	096568	835	101378	856	111896	214	115375	760
082059	171	091518	740	096575	835	101385	855	111902	168	115382	772
082073	171	091525	740	096582	835	101491	771	111919	168	115412	828
082158	205	092188	762	096599	835	101514	815	111957	102	115429	828
082172	205	092195	762	096667	767	101552	771	112084	178	115481	404
082196	205	092201	762	096674	767	101606	103	112107	178	115498	242
082240	766	092218	755	096681	767	101613	103	112268	102	115504	242
082257	205	092225	810	096698	767	102047	127	112305	182	115511	438
082264	432	092300	752	096704	767	102054	127	112312	182	115580	718
082271	766	092317	752	096711	767	103112	147	112336	182	115597	718
082288	432	092324	727	096728	767	103136	147	112343	182	115610	718
082783	337	092355	761	096735	767	103174	183	112367	132	115801	102
082790	337	092393	764	097183	392	103204	429	112626	418	115962	440
083070	714	092409	764	097190	392	103242	190	112671	112	115979	241
083087	714	092416	765	097206	392	103266	292	112695	418	116006	241
083117	714	092423	765	097664	228	103273	292	112701	129	116112	281
083124	714	092430	765	097671	228	103723	104	112718	112	116228	206
083131	714	092447	765	098616	154	103792	341	112732	129	116235	206
083148	714	092751	229	098722	199	103983	184	113302	111	116457	113
083179	714	092782	229	098739	199	103990	144	113319	111	116464	113
083186	714	092836	412	099057	407	104928	74	113678	233	116570	463
083193	714	092850	93	099064	407	104935	74	113753	758	116587	463
083223	714	092881	93	099101	187	104942	74	113760	758	116716	812
083230	714	092911	206	100326	124	105628	190	113791	759	117652	856
083247	714	092942	93	100333	124	105710	373	113975	242	117737	202
083254	716	093024	157	100364	761	105727	373	113982	716	117867	356
086736	155	093048	203	100371	761	106175	805	113999	716	117881	838
086743	155	093062	203	100388	752	106182	805	114019	716	118659	746
086781	285	093086	432	100395	752	106205	826	114170	216	118666	749
086804	460	093093	332	100746	333	107691	717	114187	216	119427	409
087368	441	093475	341	100784	333	107707	717	114194	216	119465	409
087375	441	093659	127	100791	333	108094	456	114262	104	119502	409
087665	427	093697	127	100807	333	108117	456	114279	209	119571	848
087702	190	093963	286	100883	156	108292	856	114293	758	119786	407
087719	190	093994	237	100937	156	108407	829	114347	810	120201	824
087757	436	094007	237	100944	156	109138	802	114361	103	120218	824
087764	218	094014	286	100951	156	109145	802	114620	482	120249	840
087771	218	094045	232	101125	153	110233	521	114675	341	120287	841
087818	176	094137	168	101132	282	110240	521	114682	341	120317	840
087863	332	094182	371	101163	187	110356	514	114729	209	120324	840
087870	332	094229	168	101170	336	110363	514	114736	209	120362	841
087924	157	094236	168	101187	336	110417	114	114743	209	120386	840

Indice per codice

SKU	Pag	124025	694	135205	797	140711	160	145341	739	151953	846
		124070	858	135250	730	140728	160	145358	825	151960	848
120423	771	124087	858	135526	848	140759	160	146775	769	151977	848
120430	771	124117	858	135755	807	140841	301	146782	769	151991	848
120454	815	124124	598	135762	807	140872	301	146799	769	152004	848
120898	182	124131	598	135908	805	140902	301	147642	450	152776	247
120904	182	124155	598	135922	805	140933	301	147659	450	152851	429
121130	388	124162	430	135991	722	141046	436	147666	694	152875	293
121147	388	124179	430	136004	722	141053	218	147673	694	152899	293
121154	388	125503	331	136011	722	141060	218	147680	694	152912	293
121161	388	125510	331	136028	800	141268	368	147765	750	153162	794
121178	388	125824	125	136035	800	141275	368	147772	750	153179	794
121338	388	125831	125	136042	800	141794	74	147796	750	153193	794
121352	395	126531	598	136059	800	141800	74	147819	750	153209	794
121406	519	126548	598	136073	724	141817	74	148151	106	153926	846
121437	519	126883	370	136318	175	141855	74	148175	106	153933	846
121963	749	126890	370	136325	175	141893	175	148502	106	153940	846
122014	843	126906	77	136332	129	141909	175	148847	724	153957	848
122021	843	126913	77	136349	129	142050	407	148854	724	153964	848
122045	772	128207	480	136882	370	142067	314	148861	724	153971	848
122083	110	129082	114	136899	370	142081	407	148878	724	153988	848
122106	110	129099	114	136905	370	142098	314	148908	408	154008	855
122168	854	129433	754	137032	198	142241	397	148939	518	155142	309
122205	292	129440	754	137056	198	142258	397	149561	167	155227	309
122212	292	129457	754	137391	751	142265	385	149585	168	155722	711
122236	190	129464	741	137407	751	142272	385	149592	168	155791	304
122243	190	129471	741	137681	123	142289	385	149622	317	155869	304
122557	183	129488	741	137827	519	142296	385	149738	757	155968	105
122564	183	129495	728	138237	82	142302	757	149745	757	156026	105
122663	727	129501	728	138251	364	142579	397	150116	712	156033	105
122687	727	129518	728	138275	104	142586	397	150130	712	156682	79
122717	407	129570	478	138305	167	142616	528	150284	711	156699	79
122731	314	129600	243	138374	408	142692	394	150291	712	156705	404
122748	314	129709	210	138510	807	142708	394	150307	712	156712	310
122823	860	129860	848	138596	272	142906	79	150420	304	156729	404
122830	860	129877	848	138602	272	142913	79	150437	304	156736	404
122854	860	129921	210	138619	272	142999	807	150468	304	156743	404
122861	860	130163	848	138633	274	143156	427	150475	304	156774	310
122878	484	130170	848	138640	274	143200	864	150635	76	156781	310
122885	484	130187	848	138657	274	143217	864	150673	76	157580	848
122984	407	131924	157	138978	714	143224	864	151649	846	157597	848
123080	749	131962	362	139012	712	144238	724	151656	846	157856	792
123295	860	132365	146	139029	712	144245	724	151663	846	158242	428
123301	860	132389	146	139098	123	144252	724	151687	848	158723	74
123745	763	132778	511	139425	110	144276	749	151694	848	158815	87
123769	763	133270	421	139432	110	144283	748	151700	848	158822	761
123776	763	133300	421	139470	796	144917	390	151717	848	158860	87
123783	763	133393	317	139685	111	145020	812	151724	848	158891	808
123882	848	134789	362	140179	295	145068	812	151731	846	158907	768
123899	848	134796	362	140186	295	145198	458	151748	846	159010	322
123936	855	134826	244	140193	295	145204	458	151755	848	159256	243
123943	856	134833	244	140230	157	145211	458	151762	848	159423	384
123974	694	134840	244	140339	237	145228	769	151779	848	159508	384
123981	694	134871	125	140599	437	145303	739	151786	848	159522	384
123998	694	134888	276	140605	230	145310	825	151793	846	159638	330
124001	694	134895	276	140612	230	145327	739	151861	848	159645	330
124018	694	134901	276	140629	230	145334	825	151946	846	159812	243

159836	731	163789	182	170152	650	187884	809	189819	616	192321	672
159843	109	164823	371	170589	74	187891	809	189826	616	192338	672
159850	109	164847	371	170923	359	187976	650	189833	616	192345	672
159867	109	164878	79	172408	747	187983	650	189840	616	192352	672
159942	234	164953	226	172439	806	187990	650	189857	616	192376	672
159959	234	164960	226	172804	331	188003	650	189864	616	192383	672
159973	234	164977	205	172828	331	188010	650	189871	616	192406	672
159980	234	164984	205	173245	82	188027	650	189888	616	192420	574
159997	406	164991	333	173252	364	188058	650	189895	616	192437	574
160085	247	165004	333	174204	147	188065	650	189901	616	192444	574
160214	416	165011	194	174211	147	188072	650	189918	616	192451	574
160245	416	166247	202	174228	147	188089	650	189925	616	192468	574
160269	90	166285	342	174235	147	188096	650	189932	616	192475	574
160313	318	166322	201	174396	186	188102	650	189949	616	192482	574
160856	165	166360	201	174402	186	188119	650	189956	616	192499	574
160863	165	166889	217	174792	403	188126	650	189963	616	192505	574
161327	160	167121	405	174808	403	188195	650	189970	616	192512	574
161334	160	167152	405	174822	403	188911	846	189987	616	192529	574
161365	165	167244	224	174846	403	188928	846	189994	616	192536	574
161372	165	167251	224	174921	323	188935	846	190006	616	192543	574
161389	165	167268	224	174976	323	188942	848	190013	616	192550	574
161648	188	167398	224	175973	159	188959	848	190020	616	192567	574
161662	188	167404	224	176000	159	188966	848	190037	616	192574	574
161686	472	167411	224	176031	159	188973	848	190044	616	192581	574
161716	524	167497	106	176062	159	188980	854	190051	616	192598	574
161754	785	168036	729	176352	245	189031	856	190068	616	192604	574
161761	785	168050	729	176369	245	189062	856	190075	616	192611	574
161778	785	168111	729	176536	402	189093	855	190082	616	192628	574
161785	360	168135	729	176550	402	189109	855	190099	616	192635	574
161792	360	168326	177	177199	526	189505	616	190105	616	192642	574
161846	728	168357	177	177205	526	189529	616	190181	616	192659	574
161853	728	168364	177	179292	367	189536	616	190259	616	192666	574
162201	101	168753	220	179308	367	189543	616	191171	574	192673	574
162478	101	168777	220	179315	367	189574	616	191188	574	192680	574
162492	808	168852	246	179322	367	189581	616	191416	574	192697	574
162737	211	168869	246	179643	419	189598	616	191423	574	192703	574
162751	211	168906	233	179681	384	189604	616	191430	574	192710	574
163109	110	168913	433	179858	174	189611	616	191447	574	192727	574
163123	110	168920	343	180298	408	189628	616	191454	574	192734	574
163154	110	168937	343	180304	408	189635	616	191461	574	192741	574
163161	110	168951	247	180922	243	189642	616	191478	574	192758	574
163321	411	168968	247	180946	518	189659	616	191485	574	193359	688
163338	411	169576	650	180953	786	189666	616	191492	574	193366	688
163369	500	169583	650	182179	194	189673	616	191508	574	193373	688
163536	761	169590	650	183794	856	189680	616	191577	784	193380	688
163543	761	169606	650	186955	808	189697	616	191584	784	193403	688
163550	761	169613	650	186979	808	189703	616	191607	784	193410	688
163598	762	169620	650	186986	710	189710	616	191614	783	193427	688
163604	752	169637	650	187006	414	189727	616	191621	783	193434	688
163611	752	169644	650	187327	792	189734	616	191638	783	193458	688
163628	752	169705	650	187365	359	189741	616	191980	574	193465	688
163635	752	169712	650	187525	811	189758	616	191997	574	193472	688
163642	727	169729	650	187532	811	189765	616	192277	672	193489	688
163666	727	169736	650	187549	811	189772	616	192284	672	193519	688
163727	826	169972	650	187556	811	189789	616	192291	672	193526	688
163741	802	169989	650	187662	79	189796	616	192307	672	193533	688
163758	802	170145	650	187877	809	189802	616	192314	672	193540	688

Indice per codice

SKU	Pag	198637	804	203126	598	208657	664	213569	342	222578	608
		198644	804	203133	699	208664	664	213583	201	222585	608
193946	457	199375	235	203140	699	208671	664	214009	782	222592	608
193991	457	199382	235	203171	392	208688	664	214474	154	222608	608
194172	79	199405	235	203188	392	208695	664	214481	154	222615	608
194189	79	199412	235	203195	392	208701	664	214498	284	222622	608
194196	79	199870	387	204581	598	208718	664	214504	284	222639	608
194202	79	199894	387	204598	598	208725	664	214511	284	222646	608
194257	650	199917	387	204611	598	208732	664	214672	369	222653	608
194295	106	199931	387	204628	598	208749	664	214689	369	222660	608
194301	650	199993	200	204635	598	208794	420	214696	369	222677	608
194677	119	200002	200	204888	454	208817	89	215693	429	222684	608
194684	119	200064	200	204895	454	209036	854	215709	429	222691	608
194806	74	200071	200	204949	507	209043	854	215761	279	222707	608
195483	782	200118	98	204956	507	209845	744	215778	279	222714	608
195490	782	200125	98	205281	107	209852	744	215785	279	222745	534
195506	782	200132	417	205298	107	209906	789	215969	208	222752	534
195704	354	200149	417	205304	107	211381	66	216027	664	222769	534
195711	354	200194	313	205311	107	211398	66	216263	664	222820	842
195728	354	200200	313	205977	300	211404	66	216270	574	222837	842
195735	354	200217	313	205984	300	211459	76	216287	574	222868	839
195742	354	200231	313	205991	300	211466	76	216317	664	222875	839
195759	354	200248	313	206004	300	211701	76	216324	664	222882	534
195766	354	200255	313	206011	300	211718	76	216416	574	222899	534
195773	354	200330	416	206028	300	211763	664	216423	574	222912	534
196190	280	200347	416	206035	300	211770	664	217253	672	222929	534
196206	280	200354	315	206042	300	211787	664	218724	731	222936	534
196220	280	200361	315	206196	704	211794	664	218823	688	222943	534
196688	406	200378	416	206202	704	211800	664	218830	688	222950	534
196695	406	200385	416	206219	704	211817	664	218854	688	222967	534
196701	311	200392	315	206226	704	211824	664	219875	186	222974	534
196718	311	200408	315	206233	704	211831	664	220772	688	222981	534
196770	116	200484	316	206240	704	211848	664	220789	688	222998	534
196787	116	200491	171	206387	84	211855	664	220796	688	223001	534
196794	116	200880	106	206394	84	211862	664	220802	688	223018	534
196800	116	200897	106	206622	240	211879	664	220826	574	223025	534
196992	87	200903	106	206639	240	211886	664	221489	119	223032	534
197302	100	200996	341	206806	109	211893	664	221496	119	223049	534
197319	100	201016	341	206820	109	212623	842	221502	744	223056	534
197326	100	201023	433	206875	109	212647	842	221519	744	223063	534
197333	100	201092	428	207155	433	213071	807	221595	859	223070	534
197500	239	201115	472	207162	341	213088	807	221649	664	223087	534
197524	239	201122	525	207186	341	213095	740	221656	664	223094	534
197654	185	201252	848	207216	208	213101	796	221663	664	223124	534
197661	185	201269	848	207582	516	213194	723	221670	664	223131	534
197708	435	201276	848	207599	516	213200	723	221687	664	223148	534
197715	212	201283	848	207834	91	213217	764	221694	664	223155	534
197722	212	201290	848	207841	91	213262	790	222097	66	223162	534
197739	212	201382	479	207858	91	213279	790	222103	66	223179	534
197746	212	201399	479	208398	170	213323	758	222110	66	223186	270
197753	487	202396	672	208541	664	213330	760	222257	854	223193	270
198095	140	202921	730	208558	664	213347	756	222509	608	223209	270
198125	92	202945	730	208565	664	213354	756	222523	608	223216	270
198132	327	203072	598	208572	664	213361	800	222530	608	223223	270
198149	327	203089	598	208589	664	213491	433	222547	608	223230	270
198156	327	203102	598	208596	664	213507	343	222554	608	223254	72
198620	804	203119	598	208640	664	213521	202	222561	608	223285	534

223292	534	229706	638	235547	73	242569	864	246468	650	247878	608
223704	598	229720	638	236841	752	242576	864	246499	650	247885	608
223711	598	229768	638	236858	752	242705	650	246505	650	247939	608
223728	598	229782	638	236865	727	243160	402	246512	650	247946	608
223735	598	229997	712	236957	85	243238	650	246529	650	247953	608
223742	598	230580	712	236964	85	243245	650	246536	650	247960	608
223759	598	230702	256	237251	848	243252	650	246543	650	247977	608
223766	598	230726	256	237398	180	243269	650	246550	650	247984	608
223834	848	231129	372	237428	180	243283	650	246567	650	247991	608
223919	848	231228	113	237442	180	243450	301	246574	650	248165	700
223926	848	231259	113	237497	180	243498	341	246581	650	248172	700
223933	848	231273	113	237510	180	243528	208	246598	650	248189	700
223940	848	231297	113	237664	108	243566	341	246604	650	248196	700
224275	534	231341	88	237671	108	243597	208	246611	650	248257	802
224367	856	231372	88	237794	204	243665	574	246628	650	248264	802
224541	141	231396	88	237800	204	243818	714	246796	731	248271	802
224930	386	231433	88	237930	402	243825	714	246802	731	248288	802
224954	386	231471	306	238104	126	243849	714	246819	770	248295	802
224985	386	231495	306	238135	126	243924	301	246826	770	248370	700
224992	386	231556	118	238173	126	243931	301	246833	814	248387	820
225005	386	231563	118	238210	126	243948	301	246840	814	248394	820
225029	386	231570	118	238241	101	243986	700	246857	744	248530	305
225364	608	231587	118	238333	324	243993	700	246864	744	248554	180
226026	164	231594	118	238746	181	244013	700	246871	789	248592	700
226033	164	231600	118	238838	181	244181	702	246888	805	248608	700
226040	164	231631	641	238920	181	244198	702	246895	650	248615	820
226187	839	231662	641	238944	422	244204	702	246901	650	248783	686
226194	839	232041	123	238951	422	244235	860	246918	797	248790	686
226200	839	232331	501	238975	422	244242	860	246925	747	248950	686
226217	839	232409	501	239521	431	244259	860	246932	806	248967	686
226712	72	232485	468	239545	431	244549	858	246949	747	248974	686
226729	72	232546	468	239576	431	244556	858	246956	806	248981	686
226736	72	232690	116	239590	431	244563	858	246963	790	248998	686
226743	72	232713	116	239606	431	244570	858	246970	790	249001	686
226750	72	232720	116	239613	431	244587	858	246987	792	249018	686
227580	650	232744	116	240367	272	244594	858	246994	792	249025	686
227597	650	232966	308	240374	274	244624	88	247007	650	249032	686
227672	650	232980	308	241012	171	244648	88	247045	828	249049	686
227689	650	233017	308	241036	171	244662	306	247083	757	249056	126
227825	258	233031	308	241050	316	244808	680	247144	843	249063	126
227832	258	233062	298	241296	340	244822	680	247151	843	249070	126
229010	405	233079	298	241340	166	244846	680	247229	58	249087	126
229027	405	233192	298	241357	166	244853	680	247236	58	249186	864
229034	405	233215	298	241364	166	244884	305	247243	58	249193	864
229041	405	233321	298	241517	142	245041	820	247250	58	249209	864
229058	311	233352	298	241524	142	245072	820	247267	58	249216	864
229065	311	233666	365	241968	572	245089	820	247274	58	249223	864
229072	311	233765	299	241975	572	245096	820	247281	58	249230	864
229089	311	233772	299	241982	572	245102	820	247304	189	249247	864
229461	62	233826	299	241999	572	245331	475	247618	650	249254	864
229478	62	233833	299	242002	572	245348	475	247625	650	249261	860
229485	62	233840	365	242019	365	245393	475	247632	650	249278	860
229492	62	233970	299	242040	856	246390	702	247649	650	249285	860
229508	62	234007	299	242347	90	246413	608	247779	330	249292	860
229515	62	235455	73	242378	318	246437	608	247847	702	249308	860
229676	640	235486	73	242385	416	246444	608	247854	702	249315	860
229683	640	235516	73	242392	416	246451	650	247861	608	249322	864

Indice per codice

SKU	Pag	251523	726	255941	278	259048	423	260617	396	266534	682
		251530	726	255989	361	259062	423	260624	396	266541	682
249339	864	251547	726	255996	650	259154	62	260631	396	266558	682
249452	812	251554	726	256030	650	259161	62	260648	396	266565	682
249469	812	251561	726	256047	650	259178	62	260655	396	266572	682
249476	812	251578	726	256061	650	259185	62	260662	396	266589	682
249483	812	251592	726	256078	650	259192	62	260679	396	266596	682
249490	812	252025	715	256085	650	259208	62	260853	548	266602	682
249506	812	252032	715	256092	650	259222	469	260860	548	266619	682
249513	812	252049	715	256115	650	259239	74	261164	282	266626	682
249520	812	252056	715	256122	650	259260	298	261188	282	266633	682
249629	650	252186	848	256146	650	259277	298	261195	174	266657	682
249643	608	252209	848	256429	136	259345	355	261287	822	266671	682
249650	608	252551	855	256436	136	259352	355	261294	822	266688	682
249674	608	252568	855	256443	136	259376	548	261331	818	266701	682
249681	608	252599	296	256528	848	259413	548	261355	818	266725	682
249698	608	252605	296	257235	355	259765	424	261362	818	266732	682
249704	608	252612	296	257242	355	259772	424	261379	818	266756	855
249711	702	252629	296	257617	548	259796	424	263434	78	266763	855
249728	702	252971	664	257624	548	259802	424	263441	78	266770	855
249827	719	252988	664	257631	548	259819	424	263519	286	267128	584
249834	719	252995	664	257648	548	259826	424	263632	142	267135	584
250106	399	253008	664	257655	548	259833	424	263649	142	267142	584
250113	399	253015	664	257662	548	259857	424	263656	142	267159	584
250120	399	253381	854	257686	548	259864	476	263663	78	267203	548
250137	399	253398	856	257709	548	259871	476	263670	78	267210	548
250304	168	253404	855	257716	548	259895	476	263687	78	267227	548
250311	168	253411	846	257730	548	259901	476	263700	78	267234	548
250328	168	253428	848	257747	548	259918	476	264523	149	267241	548
250335	168	253435	848	257792	548	259925	476	264547	149	267258	548
250342	168	253442	848	257839	548	259949	476	265278	457	267395	598
250359	168	253459	848	257846	548	259956	476	265285	457	267401	598
250403	624	253466	856	257877	548	259963	522	265292	508	267418	598
250410	624	253480	855	257990	548	259970	522	265308	508	267425	598
250427	624	253497	856	258003	548	259994	522	265315	509	267432	598
250434	624	253558	608	258027	548	260006	522	265322	509	267449	598
250441	624	253589	68	258140	548	260013	192	265575	382	267456	598
250458	624	253596	68	258157	548	260020	192	265643	382	267463	598
250816	795	253664	60	258171	548	260044	192	265896	548	267470	598
250823	795	253671	60	258232	548	260051	192	265957	62	267487	598
250854	773	253688	259	258249	548	260068	476	265971	254	267494	598
250878	779	253695	350	258256	548	260075	476	265988	254	267500	598
250885	779	253886	858	258270	698	260082	476	265995	254	267692	702
250946	759	253893	858	258287	307	260136	522	266008	254	267715	598
250953	798	254272	260	258300	590	260235	522	266015	254	267722	598
250977	798	254319	788	258461	681	260242	522	266022	254	267739	598
250991	742	254388	788	258478	681	260327	424	266121	548	267746	598
251004	742	254944	534	258751	66	260334	424	266145	548	267760	361
251011	742	255019	256	258768	66	260341	424	266183	548	267777	624
251028	742	255514	833	258775	66	260358	424	266251	856	267784	624
251103	92	255521	833	258874	498	260433	476	266282	854	267791	624
251110	92	255651	837	258881	452	260440	476	266299	856	267807	624
251127	469	255668	837	258898	81	260457	522	266305	856	267869	704
251226	787	255682	837	258904	498	260464	522	266497	682	267876	704
251257	787	255781	834	258911	452	260471	192	266503	682	267883	704
251295	787	255804	834	258928	81	260488	192	266510	682	267890	704
251516	726	255934	278	259017	77	260600	396	266527	682	267906	704

267913	704	269436	60	270500	592	272436	860	277011	836	282121	367
267920	700	269443	60	270517	592	272443	860	277028	836	282138	367
267937	700	269450	60	270524	592	272450	860	277035	836	282145	367
267944	700	269467	60	270531	592	272467	860	277219	367	282152	367
267951	700	269474	448	270548	592	272474	858	277226	367	282169	367
267968	672	269481	448	270586	260	272481	858	277233	367	282176	367
267975	672	269498	448	270593	260	272498	858	277240	367	282244	799
267982	704	269504	843	270661	256	272504	858	277257	367	282251	799
267999	704	269634	638	270678	256	272511	858	277288	290	282633	548
268002	704	269696	843	270692	574	272528	858	277370	98	282640	548
268071	365	269702	843	270715	260	272535	858	277387	98	282657	548
268088	698	269719	843	270876	574	272542	858	277394	98	282664	548
268095	365	269726	843	270883	574	273167	672	277417	303	282671	548
268101	307	269733	843	270920	848	273174	672	277790	848	282688	548
268118	572	269825	256	270937	574	273631	319	277813	848	282695	548
268149	572	269832	58	270944	846	273648	94	277844	360	282701	548
268156	822	269849	58	270951	848	273655	413	277851	360	282718	548
268163	822	269856	62	270968	854	273662	492	277868	360	282725	548
268170	822	269863	62	270975	856	273679	466	277912	574	282749	548
268187	822	269870	62	271002	260	273693	325	277929	574	282756	548
268194	822	269986	424	271125	592	273709	325	277967	494	282770	548
268200	822	270005	476	271187	588	273914	366	278148	780	282787	548
268217	572	270012	522	271194	588	273945	366	278704	303	282794	548
268231	572	270029	192	271200	588	274508	639	279305	497	282800	548
268293	759	270036	424	271217	588	274515	639	279312	497	282824	548
268309	759	270043	192	271293	143	274768	678	279596	658	282831	548
268316	759	270050	192	271309	143	274775	678	279602	658	282848	548
268347	773	270104	854	271316	143	274782	678	279626	658	282855	548
268354	773	270111	854	271385	96	275178	98	279633	658	282862	548
268361	773	270173	584	271392	96	275215	98	279640	658	282879	548
268422	788	270180	584	271408	96	275369	81	279671	658	282886	548
268439	788	270197	584	271422	96	275376	81	279688	658	282893	548
268989	833	270203	584	271439	415	275383	81	279695	658	282909	548
268996	833	270210	584	271446	624	275543	178	279701	658	282916	548
269009	832	270241	260	271453	624	275567	178	279718	658	282923	548
269023	832	270258	260	271538	307	275581	178	279725	658	282930	548
269061	742	270265	260	271545	307	276182	632	279770	117	282947	548
269078	742	270272	260	271590	848	276205	832	279794	117	282954	548
269092	742	270289	260	271606	848	276243	632	279800	503	282961	548
269108	742	270296	260	271613	848	276267	642	280233	658	282978	548
269115	730	270302	260	271620	846	276274	642	280240	658	282985	548
269122	730	270319	260	271637	848	276281	642	280998	398	282992	548
269139	744	270326	260	271644	846	276304	584	281001	398	283029	548
269146	744	270333	260	271712	584	276311	584	281568	122	283036	548
269153	747	270340	260	271750	584	276328	548	281582	122	283043	548
269160	806	270357	260	271880	353	276335	574	281988	534	283050	642
269221	759	270364	260	271897	353	276342	574	281995	534	283067	642
269313	757	270371	260	272030	393	276366	534	282008	548	283104	548
269320	757	270388	260	272078	454	276564	70	282015	548	283111	548
269337	68	270395	260	272085	507	276571	70	282022	548	283142	534
269351	68	270401	260	272108	818	276588	70	282039	548	283173	534
269375	68	270449	592	272139	164	276595	70	282046	548	283180	534
269382	68	270456	592	272238	470	276601	70	282053	548	283197	534
269399	350	270463	592	272245	517	276618	70	282084	517	283258	642
269405	350	270470	592	272375	855	276625	70	282091	470	283333	453
269412	259	270487	592	272382	855	276632	70	282107	95	283524	642
269429	259	270494	592	272429	860	277004	836	282114	95	283531	642

Indice per codice

SKU	Pag	285085	80	285672	860	286365	548	287911	658	291420	67
		285092	80	285689	860	286372	548	287928	658	291437	67
283548	642	285108	382	285696	860	286389	548	287935	658	291536	534
283555	642	285115	382	285702	860	286396	548	287942	658	291789	401
283562	642	285122	117	285719	860	286402	548	287959	858	291796	401
283579	642	285139	122	285726	860	286419	548	287966	858	292076	179
283586	642	285146	122	285733	860	286426	548	288147	658	292083	179
283593	642	285153	122	285740	860	286433	548	288208	854	292090	179
283609	642	285160	122	285757	860	286440	548	288215	854	292113	179
283616	642	285184	149	285764	860	286495	548	288222	856	292205	260
283623	642	285191	149	285771	860	286501	548	288239	856	292236	260
283630	642	285207	286	285788	860	286518	548	288260	328	292250	260
283647	642	285214	298	285795	860	286525	548	288277	328	292403	415
283654	642	285238	303	285801	860	286532	548	288338	548	292410	415
283661	642	285245	325	285818	860	286549	548	288345	854	292441	466
283678	642	285252	325	285825	860	286594	632	288383	855	292458	466
283685	642	285269	353	285832	860	286600	632	288390	120	292465	466
283692	642	285276	353	285849	860	286662	512	288406	120	292472	466
283708	642	285283	366	285856	860	286679	512	288420	120	292830	288
283715	642	285290	366	285863	860	286686	512	288437	120	292847	288
283722	642	285306	366	285870	860	286716	778	288444	120	292922	548
283739	642	285313	366	285887	864	286723	778	288451	120	292939	858
283746	642	285320	393	285894	864	286730	778	288475	120	292953	858
283753	642	285337	503	285900	864	286747	778	288482	120	293004	424
283760	642	285344	503	285917	864	287072	367	288543	856	293172	793
283777	642	285351	624	285924	864	287300	400	289151	451	293189	801
283784	415	285368	624	285993	548	287317	400	289168	451	293196	801
283791	96	285375	624	286006	548	287591	363	289212	846	293202	801
283807	96	285382	624	286051	548	287607	363	289229	846	293387	781
283814	96	285399	624	286068	548	287614	363	289236	848	293394	781
283821	96	285405	624	286075	548	287621	363	289243	848	293417	781
283852	548	285412	672	286082	548	287638	363	289250	848	293424	781
283920	624	285429	672	286099	548	287645	363	289281	548	293646	421
283937	624	285436	672	286105	548	287652	385	289298	548	293653	329
283944	624	285443	672	286112	548	287669	385	289304	548	293660	329
283982	86	285450	736	286129	548	287676	385	289489	324	293684	497
283999	86	285467	736	286150	548	287683	743	289496	324	293691	497
284002	86	285474	736	286167	548	287690	743	290614	548	293769	287
284019	86	285481	736	286174	548	287706	743	290621	534	293776	287
284286	326	285498	736	286181	548	287713	743	290775	297	293783	287
284309	496	285504	736	286198	548	287720	743	290782	297	293790	287
284316	467	285511	737	286204	548	287737	743	290799	297	294001	793
284330	326	285528	737	286211	548	287768	381	290805	297	294025	793
284354	496	285535	737	286228	548	287775	381	290812	297	294032	793
284361	467	285542	795	286235	548	287782	381	290829	297	294049	793
284460	83	285559	795	286242	548	287799	314	290836	297	294124	796
284477	364	285566	856	286259	548	287805	314	290843	297	295213	499
284484	502	285573	856	286266	548	287812	314	290959	495	296197	848
284491	364	285580	860	286273	548	287829	407	290966	495	296210	848
284859	312	285597	860	286280	548	287836	407	291093	453	296302	548
284866	312	285603	860	286297	548	287843	658	291109	453	296333	636
284873	640	285610	860	286303	548	287850	658	291338	67	296340	636
284880	640	285627	860	286310	548	287867	658	291345	67	296357	636
285009	407	285634	860	286327	548	287874	658	291369	67	296364	636
285016	407	285641	860	286334	548	287881	658	291376	67	296371	710
285061	62	285658	860	286341	548	287898	658	291390	67	296388	710
285078	62	285665	860	286358	548	287904	658	291406	67	296395	710

296401	710	302607	624	304380	62	306612	260	307404	120
296456	598	302614	624	304397	62	306629	260	307411	120
296463	598	302621	624	304403	62	306636	260	307428	120
296678	506	302744	624	304410	62	306643	260	307435	120
296685	506	302751	624	304427	62	306650	260	307510	548
296746	96	302768	624	304434	62	306667	260	307527	548
296753	96	302942	632	304441	62	306674	260	307534	548
296869	855	302959	632	304458	62	306681	260	307541	548
296876	855	302966	632	304465	62	306698	260	307558	548
299303	855	302973	632	304472	62	306704	70	307565	548
299310	855	302980	632	304489	350	306711	70	307572	548
299402	302	302997	632	304496	350	306728	70	307589	548
299419	302	303000	632	304502	350	306735	70	307596	548
300436	276	303017	632	304519	259	306742	70	307602	548
300443	276	303062	864	304526	259	306759	70	307619	856
300498	548	303079	864	304533	259	306766	70	307626	856
300504	548	303086	864	304540	60	306773	70	307633	855
300511	548	303093	864	304557	60	306780	801	307640	855
300528	548	303390	860	304564	60	306797	801	307695	58
300535	548	303406	860	304571	60	306803	801	307701	58
300542	548	303499	548	304588	60	306810	401	307855	855
300559	312	303505	548	304595	60	306827	401	307862	855
300566	312	303512	548	304601	424	306834	793	307879	854
300573	312	303529	548	304618	476	306841	793	307886	854
300580	312	303536	548	304625	522	306858	793	307961	70
300641	799	303543	548	304632	192	306865	793	307978	70
300658	799	303550	548	305431	854	306872	793	307985	70
301051	352	303567	548	305486	854	306889	848	307992	70
301068	352	303574	548	305608	548	306896	848	308005	70
301075	352	303581	548	305615	548	306940	421	308012	70
301594	860	303598	548	305622	848	306957	329	308029	70
301624	864	303604	548	305639	848	306964	329	308036	70
301631	864	303611	548	306322	497	306988	494	308227	801
301648	864	303628	548	306339	497	306995	95	308234	801
301655	864	303635	548	306346	297	307008	95		
301662	864	303642	548	306353	297	307015	363		
301679	864	303659	548	306360	297	307022	363		
301686	864	303666	548	306377	297	307039	363		
301693	864	303673	548	306384	297	307046	363		
301709	864	303680	548	306391	297	307053	363		
301716	864	303697	548	306407	297	307060	363		
302256	590	303703	548	306414	297	307077	860		
302263	590	303710	548	306421	864	307084	860		
302270	590	303727	548	306438	276	307091	860		
302287	590	303734	548	306445	276	307107	860		
302294	590	303741	548	306452	506	307114	860		
302348	534	303789	548	306469	506	307121	860		
302355	534	303796	548	306513	302	307138	860		
302362	534	303802	548	306520	302	307145	598		
302379	534	303819	548	306537	98	307152	598		
302539	624	303826	548	306544	98	307169	743		
302546	624	303833	548	306551	98	307176	743		
302553	624	303895	58	306568	499	307183	367		
302560	624	304113	476	306575	260	307190	367		
302577	624	304120	522	306582	260	307206	287		
302584	624	304366	62	306599	260	307213	287		
302591	624	304373	62	306605	260	307251	598		

Elenco finiture



Trasparente



Bianco



Cromo Sfumato



Acciaio



Argento



Cromo

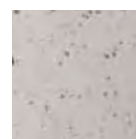

Cemento



Alluminio



Grigio

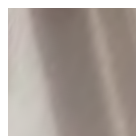

Nickel

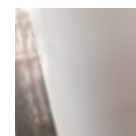

Fumè



Granito

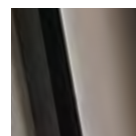

Piombo



Antracite



Nero



Avorio



Ambra



Alabastro



Beige



Canvas



Legno

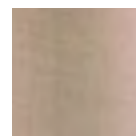

Tortora



Corda



Oro



Ottone

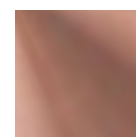

Rame

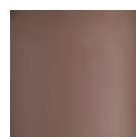

Coffee



Brunito



Corten



Ruggine

Note

Le finiture rappresentate hanno scopo illustrativo. Le tonalità sono soggette a variazioni dettate dal tipo di materiale impiegato e dalla sua lavorazione che possono alterarne la resa, di conseguenza articoli catalogati con medesima finitura potranno presentare delle differenze nella percezione del colore.

Icone tecniche



Classe I Sicurezza elettrica garantita dall'isolamento principale e da un conduttore di protezione (messa a terra) collegato alla struttura metallica della lampada. Messa a terra obbligatoria.



Classe II Sicurezza elettrica garantita dall'isolamento principale e da un doppio isolamento o da un isolamento rinforzato. Non deve avere messa a terra.



Classe III Sicurezza elettrica garantita dall'alimentazione a bassissima tensione (inferiore a 50 Volt). Non deve avere messa a terra.



Apparecchio non idoneo al montaggio diretto o incasso su superfici normalmente infiammabili.



Marchio di conformità alle direttive comunitarie europee di sicurezza.

Simboli



Lampadina inclusa.



Articoli con lampade a LED: consumo estremamente ridotto, luce chiara e concentrata, robustezza e lunga durata.



Interruttore integrato nel corpo luce.



Apparecchio dotato di interruttore touch: si accende e si regola l'intensità col tocco di un dito sul corpo luce.



Apparecchio fornito con variatore di potenza.



Lampada con presa USB integrata.



Luce indiretta inclusa.



Prodotto ad alto contenuto tecnologico, elevata qualità dei materiali, destinato ad uso professionale.



Articolo con UGR.



Articolo adatto alla pittura e verniciatura.



Grado di protezione.



Articolo in acciaio inox 316.



Lampada con rilevazione di presenza inclusa PIR (Passive InfraRed).



Lampada con batteria ricaricabile inclusa.

Note

-I prezzi indicati sono riferiti al pubblico IVA esclusa.

-Ideal lux s.r.l. si riserva il diritto di apportare, in qualunque momento e senza preavviso, tutte le modifiche necessarie a migliorare la qualità degli articoli illustrati nel presente catalogo. Per verificare le caratteristiche più aggiornate, consultare la documentazione nel sito web (www.ideal-lux.com).

-I nostri prodotti in classe I e II si alimentano con tensione nominale di 220-240 vac 50/60 hz. Tutti i nostri prodotti sono conformi alle direttive CE.

-Qualora acquistato separatamente come "optional", il driver dimmerabile sarà già incluso nel prodotto in sostituzione del driver standard on-off: verrà fornito un solo driver.

-I Watt indicati a catalogo esprimono la potenza NOMINALE dell'articolo comprensivo di sorgente e driver, quando inclusi. I valori riferiti ai lm relativi alle lampade con sorgenti integrate a LED, sono da considerarsi NOMINALI,

riferiti cioè alla sorgente. Per i lm effettivi dei singoli apparecchi illuminanti si prega gentilmente di consultare le fotometrie.

-Il valore UGR non è una caratteristica dell'apparecchio, ma dell'installazione. Gli UGR riportati in questo catalogo sono stati calcolati tenendo conto di un'installazione ideale e sono raggruppati nei blocchi <10 <13 <16 <19 <22. Si consiglia di calcolare l'UGR specifico secondo la propria installazione.

-La durata di vita utile delle sorgenti LED di tutti gli articoli presenti a catalogo è riferita al valore L70B50, quando non dichiarato altrimenti.

Ideal Lux s.r.l.

Headquarter

Via Taglio Destro, 32
30035 Mirano – Venezia
P.I. / C.F. 02420040277
8.00 - 12.00 / 13.30 - 17.30

Warehouse

Via delle Industrie, 8/D
30036 Santa Maria di Sala – Venezia
8.00 - 12.00 / 13.00 - 17.00

E info@ideal-lux.com

T +39 041 5790500

F +39 041 8872349

© [ideal.lux](https://www.ideal-lux.com)

f Ideal Lux

www.ideal-lux.com

Community Design Pending Nr. 001996372 002194993 002621862 002943449 003734342 004558609 006083655

Copyright 2023 © IDEAL LUX S.r.l. – All rights reserved – Tutti i diritti sono riservati



