

















Sospensioni, Lampade da soffitto, Lampade da parete,
Lampade da tavolo, Lampade da terra, Sistemi,
LED strip e supporti, Proiettori, Binari, Lampade da incasso,
Bollard, Lampadine, Accessori / Interno, Esterno / Minimal,
Decorativo, Architettuale /
Luce e design al servizio delle persone.

Light up your 2024.

ideal lux®

ideal lux.[®]

Indice		Indice alfabetico	004
		Indice icone	008
		Introduzione azienda	032
<hr/>			
Interni		Sospensioni	050
		Lampade da soffitto	246
		Lampade da parete	368
		Lampade da tavolo	464
		Lampade da terra	516
		Sistemi	568
		Led Strip e supporti	652
		Proiettori e binari	672
		Lampade da incasso	724
<hr/>			
Esterni		Sospensioni e soffitto	804
		Lampade da parete	816
		Bollard e lampade da tavolo	860
		Proiettori	910
		Incassi	924
<hr/>			
Lampadine		Lampadine e accessori	944
		Indice famiglie	962
		Indice per codice	978



Galaxy

Pag 098

Abc	093	Basic	768	Carta	166
Acqua	900	Basic IP65	774	Carta	293
Admiral	359	Bean	414	Carta	397
Agos	878	Bento	734	Carta	484
Alfa	330	Bergen	185	Carta	545
Alfa	427	Binomio	349	Casanova	230
Alfiere	502	Binomio	441	Celine	279
Ali	399	Birds	099	Chalet	240
A-Line	121	Birds	337	Chalet	460
Alma	406	Birds	433	Chalet	508
Amadeus	222	Birds	494	Chef	648
Ampolla	110	Birds	522	Chill	797
Andromeda	847	Birillo	491	Cima	856
Angolo	344	Bistrò	186	Cima	908
Angolo	496	Bit	926	Circus	071
Angolo	526	Blanche	216	Citrus	113
Apollo	835	Blossom	144	Clara	278
Arca	570	Blues	800	Click	383
Arcadia	877	Boa	167	Clio	808
Archimede	123	Bon Bon	235	Clio	808
Argo	845	Book	421	Clio	855
Aria	150	Bow	408	Clio	906
Arizona	154	Box	379	Clip	381
Arizona	288	Breeze	129	Cloud	294
Armony	360	Bright	384	Clown	158
Atena	898	Brigitta	233	Cocktail	139
Atlas	341	Bubble	814	Coco	182
Atom	843	Bubble	854	Colonna	562
Atrium	289	Byte	706	Colossal	218
Audi-10	188	Byte Led	707	Comet	546
Audi-20	146	Caesar	211	Cometa	852
Audi-77	209	Calypso	200	Comfort	540
Audi-80	189	Calypso	454	Compo	355
Audio	527	Camerino	400	Cono	136
Aura	309	Canapa	243	Copernico	104
Aura	778	Candy	156	Corolla	295
Avenue	929	Candy	290	Corte	217
Avion	175	Candy	486	Corte	457
Axel	498	Cantina	133	Cosmo	905
Axel	553	Cantina	438	Cosmopolitan	343
Balance	382	Carlton	204	Cotton	157
Barber	426	Carlton	367	Cotton	291
Base	840	Carlton	455	Cover	376

Indice alfabetico

Craft	085	Duchessa	513	Fish	089	Glory	153	Karousel	086
Craft	386	Dynamic	740	Fisherman	133	Glory	286	Kate	512
Craft	538	Dynamite	090	Fix	378	Gocce	135	Kelly	478
Cream	490	Dynamite	320	Flam	134	Goose	412	Keope	834
Crown	064	Dynamo	413	Flash	390	Gourmet	340	Kepler	105
Cube	382	Easy	474	Flash Gesso	391	Gravity	939	Kepler	434
Cylinder	193	Easy	539	Flat	278	Gretel	187	Kid	452
Cylinder	560	Echo	388	Floor	936	Groove	776	King	200
Daddy	550	Eclissi	445	Florian	224	Gru	470	King	358
Dafne	857	Edison	115	Florian	458	Gun	811	Klimt	555
Dafne	909	Edison	428	Fluo	632	Gun	836	Komodo	419
Daisy	354	Edo	493	Flut	141	Halo	268	Konse	109
Danieli	232	Edo Outdoor	901	Fly	258	Harem	239	Kubiko	314
Deca	245	Ego	584	Focus	410	Harem	462	Kuky	137
Decor	183	Elio	822	Folk	149	Haunt	242	Kurt	885
Dedra	859	Elio	918	Forcola	564	Hermes	350	Lana	151
Deep	766	Elisir	203	Fox	690	Hilton	195	Lana	306
Delta	385	Elvis	542	Frame	072	Hilton	448	Landing	940
Desk	084	Eminent	552	Frame	254	Hilton	501	Lawyer	481
Desk	386	Empire	178	Frame	528	Hilton	563	Le Roy	514
Diamond	096	Eos	698	Frida	114	Holiday	450	Leaves	106
Diamond	483	Equinox	102	Frida	431	Holly	124	Led Panel	784
Diesis	122	Equinox	437	Funky	798	Hotel	451	Lena	151
Diesis	475	Equinox	525	Futura	476	Hub	891	Level	286
Diesis	539	Eris	132	Futura	541	Hula hoop	070	Lido	180
Disco	108	Essence	082	Galaxy	098	Ice	112	Lift	541
Display	710	Essence	402	Game	748	Igor	095	Lika	319
Djambe	870	Etere	831	Gas	825	Igor	432	Lika	786
Dna	172	Etere	902	Gas	890	Iko	841	Linea	838
Doc	114	Eva	532	Gea	453	Impero	229	Lingotto	094
Dodo	425	Evasione	209	Geko	285	Indio	928	Lingotto	345
Doge	231	Fade	145	Gemini	060	Inside	922	Lingotto	497
Doris	872	Febe	858	Gemini	282	Io	411	Link	718
Dorsale	548	Felix	849	Gemma	308	Ipotesi	893	Linus	387
Dot	316	Fiesta	815	Giada	202	Iride	353	Linus	630
Down	858	Filo	078	Gim	424	Itaca	876	Lite	417
Dream Big	174	Filo	404	Gingle	284	Jazz	798	Litio	823
Driftwood	241	Filo	404	Gioconda	228	Jedi	895	Litio	919
Driftwood	506	Filo	530	Gioconda	459	Johnny	480	Lolita	865
Driftwood	554	Firenze	236	Giove	848	Justine	237	London	499
Dubai	210	Firenze	460	Giudecca	223	Kali	503	London	557
Dubai	365	Firenze	509	Glim	329	Karma	148	Look	074
Dubai	455	Firenze	567	Glim	705	Karol	256	Look	310

Indice alfabetico

Look	393	Minor	091	Oby	426	Penta	352	Rain	364
Look	534	Mint	184	Ocean	279	Penta	443	Ray	270
Look	708	Miramare	234	Octopus	339	Perlage	100	Read	420
Lord	144	Mirror-10	408	Off	762	Perlage	334	Regol	556
Lounge	798	Mirror-20	409	Office	646	Perlage	435	Relax	280
Lucciola	088	Mix Up	126	Oil	118	Perlage	495	Retrò	409
Luce Max	160	Mix Up	300	Omega R.	820	Perlage	524	Rex-1	850
Lugano	113	Mix Up	536	Omega S.	821	Perline	099	Rex-2	851
Lumiere	176	Moby	130	One	756	Peter	461	Rex-3	851
Lumiere	346	Monet	213	Onion	111	Petit	322	Rhapsody	087
Lumiere	482	Mood	315	Opera	198	Phoenix	191	Riflesso	407
Lumiere	520	Moonlight	363	Opera	456	Piano	418	Ritz	305
Luna	807	Moris	378	Opera	511	Ping Pong	348	Rocket	942
Luna	874	Mouse	324	Opera	565	Ping Pong	440	Rocket Mini	943
Luxor	208	Mouse	422	Oracle	070	Ping Pong	488	Roma	205
Luxury	450	Mouse	704	Oracle Slim	066	Ping Pong	533	Roma	356
Luxury	500	Mr Jack	117	Oracle Slim	252	Pipe	416	Roma	454
Luxury	561	Multiflex	175	Orbit	058	Pivot	471	Roma	510
Madame	190	Multiflex	339	Origami	142	Planet	298	Room-65	799
Magnolia	365	Nabucco	206	Orion	201	Play	321	Rose	219
Make Up	407	Napoleon	226	Ovalino	155	Play	780	Royal	364
Manhattan	141	Negresco	220	Ovalino	294	Plissè	150	Rubber	168
Mapa Bianco	164	Negresco	458	Ovalino	394	Polar	853	Rubik	842
Mapa Bianco	292	Nemo	170	Oz	062	Polka	802	Rudy	326
Mapa Bianco	396	Net	107	Oz	257	Polly	544	Rudy	423
Mapa Bianco	487	Neve	362	Oz	374	Pop	089	Sally	479
Mapa Fade	162	Newton	438	Oz	468	Posta	380	Samba	794
Mapa Max	161	Newton	542	Page	415	Pouche	377	Santa	463
Mapa Plus	159	Ninfea	351	Pagoda	551	Pov	702	Sasso	875
Mapa Sat	161	Ninfea	443	Pan	192	Prato	492	Set Up	196
Maracas	331	Nitro	312	Pan	442	Pretty	400	Set Up	302
Maracas	436	Nodi	173	Park	938	Privè	401	Set Up	446
Marte	886	Nodi	332	Pashà	207	Probe	420	Set Up	504
Martinez	203	Nodino	333	Pashà	357	Profilo	328	Set Up	558
Martinez	366	Nordik	192	Pashà	454	Pulsar	899	Shell	307
Medea	853	Nordik	450	Path	889	Punto	839	Shower	439
Mercurio	887	Nordik	500	Paul	394	Pure	864	Simply	306
Metro	129	Nordik	560	Pauline	338	Quark	760	Sirio	882
Mib	814	Norma	244	Pegaso	214	Queen	514	Sky	077
Milk	138	Nova	782	Pegaso	457	Queen	566	Sky	311
Millennium	212	Oak	076	Pegaso	515	Quick	674	Sky	392
Minimal	116	Oak	318	Pegaso	566	Radio	429	Slem	330
Minimal	430	Oby	325	Peggy	377	Rain	202	Slem	427

Slot	664	Tetris-1	844	Walky	803
Smarties	152	Tetris-2	845	Wally	479
Smarties	287	Theo	405	Wally	543
Smarties	397	Thor	912	Way	941
Smarties	485	Tick	444	Wheel	194
Smile	682	Tiepolo	221	Wheel	305
Snell	507	Tifone	892	Winery	323
Snif Round	832	Titano	884	Winery	428
Snif Square	833	Toby	321	Wire	927
Soda	395	Toffee	867	Woody	194
Soft	181	Toki	866	Woody	304
Sole	806	Tolomeo	147	Woody	449
Sole	873	Torre	904	Xeno	812
Soul	801	Totem	281	Xeno	826
Spark	105	Tower	318	Yoko	083
Spark	342	Triade	125	Yoko	473
Spike	317	Triplo	398	Yoko	531
Spot	324	Tristan	140	York	555
Spot	422	Triumph	092	Yurta	128
Spot	704	Triumph	336	Zephyr	796
Stardust	868	Triumph	436	Zeus	726
Starlight	914	Tronco	830	Zig Zag	389
Steel	642	Tronco	896	Ziggy	296
Stick	616	Truman	480		
Strauss	229	Tube	076		
Strauss	459	Tudor	399		
Style	828	Twin	846		
Style	880	Ulex	916		
Sun	869	Ulisse	154		
Sunglasses	812	Ultrathin	080		
Sunrise	445	Umile	143		
Swan	199	Universal R.	274		
Swan	456	Universal S.	276		
Swing	798	Up	844		
Swipe	827	Urano	813		
Syntesi	375	Vanity	238		
Tall	120	Vega	894		
Taurus	930	Venus	899		
Techo	810	Virtus	383		
Terra	824	Virus	758		
Terra	920	Vision	658		
Tesi	656	V-Line	083		
Tesla	888	Vortex	106		

Lumiere

Pag 520



















































Orbit

Pag 058



























































Indice icone

Interni Sospensioni

<small>new</small>	<small>new</small>		<small>new</small>			
						
Orbit 058	Gemini 060	Oz 062	Crown 064	OracleSlim 066	Oracle 070	Hula hoop 070
		<small>new</small>				<small>new</small>
						
Circus 071	Frame 072	Look 074	Tube 076	Oak 076	Sky 077	Filo 078
<small>new</small>						
						
Ultrathin 080	Essence 082	Yoko 083	V-Line 083	Desk 084	Craft 085	Karousel 086
						
Rhapsody 087	Lucciola 088	Fish 089	Pop 089	Dynamite 090	Minor 091	Triumph 092
	<small>new</small>		<small>new</small>	<small>new</small>		
Abc 093	Lingotto 094	Igor 095	Diamond 096	Galaxy 098	Birds 099	Perline 099
<small>new</small>	<small>new</small>					
						
Perlage 100	Equinoxe 102	Copernico 104	Kepler 105	Spark 105	Leaves 106	Vortex 106
<small>new</small>						
						
Net 107	Disco 108	Konse 109	Ampolla 110	Onion 111	Ice 112	Citrus 113

Interni

Sospensioni

			<small>new</small> 			<small>new</small> 
Lugano 113	Frida 114	Doc 114	Edison 115	Minimal 116	Mr Jack 117	Oil 118
						
Archimede 123	Holly 124	Triade 125	Mix Up 126	Yurta 128	Metro 129	Breeze 129
						
Cantina 133	Flam 134	Gocce 135	Cono 136	Kuky 137	Milk 138	Cocktail 139
						
Origami 142	Umile 143	Blossom 144	Lord 144	Fade 145	Audi-20 146	Tolomeo 147
						
Plissé 150	Lana 151	Lena 151	Smarties 152	Glory 153	Ulisse 154	Arizona 154
						<small>new</small> 
Clown 158	Mapa Plus 159	Luce Max 160	Mapa Sat 161	Mapa Max 161	Mapa Fade 162	MapaBianco 164
						<small>new</small> 
Nemo 170	Dna 172	Nodi 173	Dream Big 174	Avion 175	Multiflex 175	Lumiere 176
						
Coco 182	Decor 183	Mint 184	Bergen 185	Bistrò 186	Gretel 187	Audi-10 188



Tall 120

A-Line 121

Diesis 122



Moby 130

Eris 132

Fisherman 133



Tristan 140

Manhattan 141

Flut 141



Karma 148

Folk 149

Aria 150



Ovalino 155

Candy 156

Cotton 157



Carta 166

Boa 167

Rubber 168



new

Empire 178

Lido 180

Soft 181



Audi-80 189

Madame 190

Phoenix 191



Cotton

Pag. 157



Casanova

Pag 230



Pan 192



Nordik 192



Calypso 200



King 200



Nabucco 206



Pashà 207



Pegaso 214



Blanche 216



Florian 224



Napoleon 226



Miramare 234



Bon Bon 235

Interni

Sospensioni



Cylinder 193



Woody 194



Wheel 194



Hilton 195



Set Up 196



Opera 198



Swan 199



Orion 201



Rain 202



Giada 202



Elisir 203



Martinez 203



Carlton 204



Roma 205



Luxor 208



Evasione 209



Audi-77 209



Dubai 210



Caesar 211



Millennium 212



Monet 213



Corte 217



Colossal 218



Rose 219



Negresco 220



Tiepolo 221



Amadeus 222



Giudecca 223



Gioconda 228



Impero 229



Strauss 229



Casanova 230



Doge 231



Danieli 232



Brigitta 233



Firenze 236



Justine 237



Vanity 238



Harem 239



Chalet 240



Driftwood 241



Haut 242



Canapa 243



























































Norma 244



Deca 245

Interni

Lampade da soffitto

						 <small>new</small>
Oracle Slim 252	Frame 254	Karol 256	Oz 257	Fly 258	Halo 268	Ray 270
						 <small>new</small>
Clara 278	Flat 278	Celine 279	Ocean 279	Relax 280	Totem 281	Gemini 282
				 <small>new</small>		 <small>new</small>
Glory 286	Level 286	Smarties 287	Arizona 288	Atrium 289	Candy 290	Cotton 291
		 <small>new</small>	 <small>new</small>	 <small>new</small>		
Ovalino 294	Cloud 294	Corolla 295	Ziggy 296	Planet 298	Mix Up 300	Set Up 302
						
Ritz 305	Simply 306	Lana 306	Shell 307	Gemma 308	Aura 309	Look 310
 <small>new</small>		 <small>new</small>	 <small>new</small>			
Kubiko 314	Mood 315	Dot 316	Spike 317	Oak 318	Tower 318	Lika 319
 <small>new</small>						 <small>new</small>
Toby 321	Petit 322	Winery 323	Mouse 324	Spot 324	Oby 325	Rudy 326
					 <small>new</small>	
Alfa 330	Slem 330	Maracas 331	Nodi 332	Nodino 333	Perlage 334	Triumph 336

new



Universal R. 274

new



Universal S. 276



Gingle 284



Geko 285

new



MapaBianco 292



Carta 293



Woody 304



Wheel 305

new



Sky 311



Nitro 312



Dynamite 320



Play 321

new



Profilo 328



Glim 329



Birds 337



Pauline 338

Gemini

Pag 282































Armony

Pag 360



Interni

Lampade da soffitto

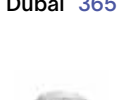
			 new		 new	
Multiflex 339	Octopus 339	Gourmet 340	Atlas 341	Spark 342	Cosmopolitan 343	Angolo 344
 new	 new	 new	 new	 new		 new
Lingotto 345	Lumiere 346	Ping Pong 348	Binomio 349	Hermès 350	Ninfea 351	Penta 352
 new						
Iride 353	Daisy 354	Compo 355	Roma 356	Pashà 357	King 358	Admiral 359
 new						
Armony 360	Neve 362	Moonlight 363	Royal 364	Rain 364	Magnolia 365	Dubai 365
						
					Martinez 366	Carlton 367

Filo

Pag 404



Oz 374



Syntesi 375



Clip 381



Cube 382



Linus 387



Echo 388



Soda 395

new



MapaBianco 396



Privè 401



Essence 402



Retrò 409



Mirror-20 409



Lite 417



Piano 418



Gim 424

















































new



Dodo 425

Interni

Lampade da parete

						
Cover 376	Peggy 377	Pouche 377	Fix 378	Moris 378	Box 379	Posta 380
new						
Balance 382	Virtus 383	Click 383	Bright 384	Delta 385	Desk 386	Craft 386
						
Zig Zag 389	Flash 390	FlashGesso 391	Sky 392	Look 393	Paul 394	Ovalino 394
	new					
Smarties 397	Carta 397	Triplo 398	Ali 399	Tudor 399	Camerino 400	Pretty 400
new	new					new
Filo 404	Theo 405	Alma 406	Make Up 407	Riflesso 407	Bow 408	Mirror-10 408
						
Focus 410	IO 411	Goose 412	Dynamo 413	Bean 414	Page 415	Pipe 416
						new
Komodo 419	Probe 420	Read 420	Book 421	Mouse 422	Spot 422	Rudy 423
						
Oby 426	Barber 426	Alfa 427	Slem 427	Winery 428	Edison 428	Radio 429

Interni

Lampade da parete



Minimal 430



Frida 431



Igor 432



Birds 433



Kepler 434

new



Perlage 435



Triumph 436



Cantina 438



Newton 438



Shower 439

new



Ping Pong 440

new



Binomio 441



Pan 442

new



Penta 443



Eclissi 445



Sunrise 445



Set Up 446



Hilton 448



Woody 449



Luxury 450



Nordik 450

new



Kid 452



Gea 453



Calypso 454



Roma 454



Pashà 454



Carlton 455



Dubai 455



Corte 457



Pegaso 457



Negresco 458



Florian 458



Gioconda 459



Strauss 459



Firenze 460



Harem 462



Santa 463



Maracas 436



Equinoxe 437



Ninfea 443



Tick 444



Holiday 450



Hotel 451



Opera 456



Swan 456



Chalet 460



Peter 461

Ping Pong

Pag 440



















































Easy

Pag 474



Interni

Lampade da tavolo

			new 		new 	
Oz 468	Gru 470	Pivot 471	Filo 472	Yoko 473	Easy 474	Diesis 475
				new 		
Futura 476	Kelly 478	Sally 479	Wally 479	Johnny 480	Truman 480	Lawyer 481
new 	new 	new 	new 		new 	new 
Lumiere 482	Diamond 483	Carta 484	Smarties 485	Candy 486	MapaBianco 487	Ping Pong 488
new 					new 	
Cream 490	Birillo 491	Prato 492	Edo 493	Birds 494	Perlage 495	Angolo 496
						
Lingotto 497	Axel 498	London 499	Luxury 500	Nordik 500	Hilton 501	Alfiere 502
						
Kali 503	Set Up 504	Driftwood 506	Snell 507	Chalet 508	Firenze 509	Roma 510
						
Opera 511	Kate 512	Duchessa 513	Queen 514	Le Roy 514	Pegaso 515	

Interni

Lampade da terra



Lumiere 520

Birds 522

Perlage 524

Equinoxe 525

Angolo 526

Audio 527

Frame 528



Easy 539

Diosis 539

Comfort 540

Lift 541

Futura 541

Newton 542

Elvis 542



Daddy 550

Pagoda 551

Eminent 552

Axel 554

Driftwood 553

York 555



Filo 530



Yoko 531



Eva 532

new



Ping Pong 533

new



Look 534

new



Mix Up 536



Craft 538



Wally 543



Polly 544

new



Carta 545

new



Comet 546



Dorsale 548



Klimt 555



Regol 556



London 557



Set Up 558



Cylinder 560



Nordik 560



Luxury 561



Colonna 562



Hilton 563



Forcola 564



Opera 565



Queen 566



Pegaso 566



Firenze 567

Interni

Sistemi



Arca 570

Ego 584

Stick 616

Linus 630

Fluo 632



Steel 642

Office 646

Chef 648

LED strip e supporti



Strip 654

Tesi 656

Vision 658

Slot 664

Proiettori e binari



Quick 674

Smile 682

Fox 690

Eos 698

Pov 702



Mouse 704

Spot 704

Glim 705

Byte 706

Byte LED 707

































Look 708

Display 710

Link 718

Lampade da incasso

<small>new</small>				<small>new</small>	
Zeus 726	Bento 734	Dynamic 740	Game 748		
		<small>new</small>			
One 756	Virus 758	Quark 760	Off 762		
		<small>new</small>			
Deep 766	Basic 768	Basic IP65 774	Groove 776		
					
Aura 778	Play 780	Nova 782	Led Panel 784		
<small>new</small>				<small>new</small>	
Lika 786	Samba 794	Zephyr 796	Chill 797		
					
Jazz 798	Swing 798	Lounge 798	Funky 798		
					
Room-65 799	Blues 800	Soul 801	Soul 801		
					
Polka 802	Walky 803				



Dedra

Pag 859



Sospensioni e soffitto

new



Sole 806



Luna 807

new



Clio 808

new



Clio 808

new



Clio 808

new



Clio 808

new



Clio 808

new



Clio 808

new



Techo 810



Gun 811



Sunglasses 812



Xeno 812



Urano 813



Bubble 814



Mib 814



Fiesta 815

Esterni

Lampade da parete

new



Omega R. 820



Omega S. 821



Elio 822



Litio 823



Terra 824



Gas 825



Xeno 826

new



Swipe 827

new



Style 828

new



Tronco 830

new



Etere 831



Snif Round 832



Snif Square 833



Keope 834

new



Linea 838

new



Punto 839



Base 840

new



Rubik 842

Apollo 835

Gun 836

new



new



new



new



new



Iko 841



Atom 843

Up 844

Tetris-1 844

Tetris-2 845

Argo 845

Twin 846

Andromeda 847

new



new



Giove 848

Felix 849

Rex-1 850

Rex-2 851

Rex-3 851

Cometa 852

Polar 853



new



new



new



Medea 853

Bubble 854

Clio 855

Clio 855

Clio 855

Cima 856

Dafne 857



Down 858



new

Febe 858



new

Dedra 859

Esterni

Bollard e lampade da tavolo

<small>new</small> 		<small>new</small> 	<small>new</small> 			
Pure 864	Lolita 865	Toki 866	Toffee 867	Stardust 868	Sun 869	Djambe 870
	<small>new</small> 				<small>new</small> 	<small>new</small> 
Doris 872	Sole 873	Luna 874	Sasso 875	Itaca 876	Arcadia 877	Agos 878
<small>new</small> 						<small>new</small> 
Style 880	Sirio 882	Titano 884	Kurt 885	Marte 886	Mercurio 887	Tesla 888
	<small>new</small> 					
Path 889	Gas 890	Hub 891	Tifone 892	Ipotesi 893	Vega 894	Jedi 895
						<small>new</small> 
Tronco 896	Atena 898	Pulsar 899	Venus 899	Acqua 900	Edo Outdoor 901	Etere 902
<small>new</small> 		<small>new</small> 	<small>new</small> 	<small>new</small> 		
Torre 904	Cosmo 905	Clio 906	Clio 906	Clio 906	Cima 908	Dafne 909

Proiettori

new



Thor 912



Starlight 914



Ulex 916



Elio 918



Litio 919



Terra 920



Inside 922

Incassi



Bit 926



Wire 927



Indio 928



Avenue 929

new



Taurus 930



Floor 936



Park 938



Gravity 939



Landing 940



Way 941



Rocket 942



RocketMini 943



Toffee

Pag 867

“C'è un gesto quotidiano
che ognuno di noi compie
al sopraggiungere del buio.
Un rito familiare che
rappresenta gioia, sicurezza,
momento dedicato allo
stare insieme.

**Accendere una luce è
un'azione semplice,
ma carica di significati.
Da qui inizia la nostra storia.”**





Light up your moments

Ideal lux **si impegna ogni giorno per diventare** il punto di riferimento nella scelta di una lampada che esprima la propria personalità attraverso un complemento d'arredo unico e attuale.

Tutto nasce nel 1974, dall'intuizione di ideare complementi d'arredo illuminotecnici attuali e accessibili. Da allora, ideal lux si impegna ad ascoltare le necessità di tutti, proponendo un'ampissima varietà di stili di illuminazione e **venendo incontro** a ogni esigenza funzionale. Che sia una famiglia, un'attività commerciale o una persona all'inizio

della sua avventura in una nuova casa, ideal lux promette **componenti all'altezza di esigenze e sogni.**

Il punto di forza, irrinunciabile quando si parla di vicinanza tra azienda e persone, è un catalogo che va incontro a qualunque tipo di esigenza: **più di 3.000 complementi d'arredo** che spaziano tra tantissime linee prodotte, dai complementi da interno ed esterno, fino ad arrivare a quelli più tecnici.



Giving shape to light

Quando si parla di soluzioni da interno, l'obiettivo di ideal lux è quello di **creare scenografie** versatili per tutti gli ambienti, lasciando **vivere ogni momento** con la giusta atmosfera e offrendo a tutti la possibilità di **sperimentare con la propria idea di casa**. Anche fuori, le soluzioni proposte per gli spazi esterni non rinunciano a estetica e sicurezza, restando un piacevole **elemento di design** anche nei momenti in cui si ha bisogno di un po' d'aria.

Per gli spazi professionali, che richiedono **un'attenzione tecnica particolare**, ideal lux ha pensato di lavorare su tantissime proposte che aiutano a distribuire la luce nella giusta direzione dando maggiore

resa ai colori, senza mai perdere di vista il design e **rendendo unici** anche gli spazi in cui si creano relazioni professionali.

Ma se da una parte garantire la scelta e proporre un catalogo vasto costituisce un obiettivo commerciale molto importante, dall'altra, anche **la relazione con i clienti** è un aspetto che ideal lux coltiva con meticolosa cura. Come lo fa? Assicurando la possibilità di acquistare un prodotto di design, aggiornato alle tendenze più attuali e, soprattutto, accessibile a tutti. Che lo stile preferito sia industrial, minimal, classico, contemporaneo, moderno o eclettico... chiunque lo desideri può **entrare nel mondo ideal lux**.











Studio Impero
Rome, RM
Planned out by ARCH.0



Studio Impero
Rome, RM
Planned out by ARCH.0

Per ideal lux una lampada è molto più di un oggetto. L'illuminazione ha il potere di **influenzare la quotidianità**, donando **carattere e personalità uniche agli ambienti**. Per questo, ogni giorno ideal lux si impegna ad ascoltare le persone e le loro storie, con l'obiettivo di coltivare un **rapporto autentico e spontaneo**, e trovando nel racconto nuovi punti di vista, nuove ispirazioni.

Il **Customer Care** costituisce un ramo importante dell'azienda, distinguendosi per la cura e per l'attenzione che dedica ai clienti e facendo dell'affidabilità

uno dei principi più importanti. **L'attenzione per le persone è centrale**. Con ideal lux la luce diventa quell'elemento della quotidianità capace di **trasformare l'ordinario in straordinario**. Perché accada, è importante scegliere l'illuminazione adatta alle proprie esigenze, perché con la luce giusta ogni ambiente può assumere **tutta un'altra forma, un'altra storia**.

The ordinary is extraordinary

Un brand, tante persone.

Crederci nelle persone è una scelta che facciamo ogni giorno. Valorizziamo i dipendenti, crescendo giorno dopo giorno assieme a loro, e costruiamo relazioni durature e trasparenti con clienti e fornitori.

Il design alla portata di tutti.

Vogliamo far entrare il design nella quotidianità delle persone, con soluzioni luminose esteticamente belle e funzionali, ma a costi contenuti.

Saper ascoltare.

Ci impegniamo a comprendere le necessità e i sogni dei clienti e a trasformare le difficoltà in occasioni, con l'obiettivo di migliorare costantemente in questa direzione.

Non c'è qualità senza garanzia.

Abbiamo esteso la garanzia di tutti i nostri complementi illuminotecnici a 5 anni, per assicurare in ogni momento una qualità elevata di prodotto e servizio.

Un brand,
tante persone.

Saper
ascoltare.

Non c'è
qualità senza
garanzia.

Il design
alla portata
di tutti.

Cliente



Your projects,

Projects — Private house

Turin, Italy

Planned out by
Nicoletta Carbotti

Products:
Mapa Bianco, Swing.



light up by

Projects — Bolero Estudio

Las Palmas de Gran Canaria, Spain

Products:
Ego.







our products.

Projects — Albergo Dimaro

Trento, Italy

Planned out by
MEA Studio

Products:
Diesis, Read, Yoko.





Interni

Sospensioni



Indice alfabetico

Abc	093	Citrus	113	Essence	082
A-Line	121	Clown	158	Evasione	209
Amadeus	222	Cocktail	139	Fade	145
Ampolla	110	Coco	182	Filo	078
Archimede	123	Colossal	218	Firenze	236
Aria	150	Cono	136	Fish	089
Arizona	154	Copernico	104	Fisherman	133
Audi-10	188	Corte	217	Flam	134
Audi-20	146	Cotton	157	Florian	224
Audi-77	209	Craft	085	Flut	141
Audi-80	189	Crown	064	Folk	149
Avion	175	Cylinder	193	Frame	072
Bergen	185	Danieli	232	Frida	114
Birds	099	Deca	245	Galaxy	098
Bistrò	186	Decor	183	Gemini	060
Blanche	216	Desk	084	Giada	202
Blossom	144	Diamond	096	Gioconda	228
Boa	167	Diesis	122	Giudecca	223
Bon Bon	235	Disco	108	Glory	153
Breeze	129	Dna	172	Gocce	135
Brigitta	233	Doc	114	Gretel	187
Caesar	211	Doge	231	Harem	239
Calypso	200	Dream Big	174	Haunt	242
Canapa	243	Driftwood	241	Hilton	195
Candy	156	Dubai	210	Holly	124
Cantina	133	Dynamite	090	Hulahoop	070
Carlton	204	Edison	115	Ice	112
Carta	166	Elisir	203	Igor	095
Casanova	230	Empire	178	Impero	229
Chalet	240	Equinoxe	102	Justine	237
Circus	071	Eris	132	Karma	148



Indice alfabetico

























































Karousel	086	Nordik	192	Vanity	238
Kepler	105	Norma	244	V-Line	083
King	200	Oak	076	Vortex	106
Konse	109	Oil	118	Wheel	194
Kuky	137	Onion	111	Woody	194
Lana	151	Opera	198	Yoko	083
Leaves	106	Oracle	070	Yurta	128
Lena	151	Oracle Slim	066		
Lido	180	Orbit	058		
Lingotto	094	Origami	142		
Look	074	Orion	201		
Lord	144	Ovalino	155		
Lucciola	088	Oz	62		
Luce Max	160	Pan	192		
Lugano	113	Pashà	207		
Lumiere	176	Pegaso	214		
Luxor	208	Perlage	100		
Madame	190	Perline	099		
Manhattan	141	Phoenix	191		
Mapa Bianco	164	Plisse'	150		
Mapa Fade	162	Pop	089		
Mapa Max	161	Rain	202		
Mapa Plus	159	Rhapsody	087		
Mapa Sat	161	Roma	205		
Martinez	203	Rose	219		
Metro	129	Rubber	168		
Milk	138	Set Up	196		
Millennium	212	Sky	077		
Minimal	116	Smarties	152		
Minor	091	Soft	181		
Mint	184	Spark	105		
Miramare	234	Strauss	229		
Mix Up	126	Swan	199		
Moby	130	Tall	120		
Monet	213	Tiepolo	221		
Mr Jack	117	Tolomeo	147		
Multiflex	175	Triade	125		
Nabucco	206	Tristan	140		
Napoleon	226	Triumph	092		
Negresco	220	Tube	076		
Nemo	170	Ulisse	154		
Net	107	Ultrathin	080		
Nodi	173	Umile	143		

Diamond

Pag 096



















































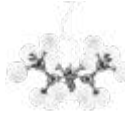





Interni

Indice icone

 <small>new</small>	 <small>new</small>		 <small>new</small>			
Orbit 058	Gemini 060	Oz 062	Crown 064	OracleSlim 066	Oracle 070	Hulahoop 070
		 <small>new</small>				 <small>new</small>
Circus 071	Frame 072	Look 074	Tube 076	Oak 076	Sky 077	Filo 078
 <small>new</small>						
Ultrathin 080	Essence 082	Yoko 083	V-Line 083	Desk 084	Craft 085	Karousel 086
						
Rhapsody 087	Lucciola 088	Fish 089	Pop 089	Dynamite 090	Minor 091	Triumph 092
	 <small>new</small>		 <small>new</small>	 <small>new</small>		
Abc 093	Lingotto 094	Igor 095	Diamond 096	Galaxy 098	Birds 099	Perline 099
 <small>new</small>	 <small>new</small>					
Perlage 100	Equinoxe 102	Copernico 104	Kepler 105	Spark 105	Leaves 106	Vortex 106
 <small>new</small>						
Net 107	Disco 108	Konse 109	Ampolla 110	Onion 111	Ice 112	Citrus 113
						
Lugano 113	Frida 114	Doc 114	Edison 115	Minimal 116	Mr Jack 117	Oil 118

Interni

Indice icone

			new 			new 
Tall 120	A-Line 121	Diesis 122	Archimede 123	Holly 124	Triade 125	Mix Up 126
						
Moby 130	Eris 132	Fisherman 133	Cantina 133	Flam 134	Gocce 135	Cono 136
						
Tristan 140	Manhattan 141	Flut 141	Origami 142	Umile 143	Blossom 144	Lord 144
						
Karma 148	Folk 149	Aria 150	Plissé 150	Lana 151	Lena 151	Smarties 152
		new 				
Ovalino 155	Candy 156	Cotton 157	Clown 158	Mapa Plus 159	Luce Max 160	Mapa Sat 161
						
Carta 166	Boa 167	Rubber 168	Nemo 170	Dna 172	Nodi 173	Dream Big 174
new 						
Empire 178	Lido 180	Soft 181	Coco 182	Decor 183	Mint 184	Bergen 185
						
Audi-80 189	Madame 190	Phoenix 191	Pan 192	Nordik 192	Cylinder 193	Woody 194



Yurta 128



Metro 129



Breeze 129



Kuky 137



Milk 138



Cocktail 139



Fade 145



Audi-20 146



Tolomeo 147



Glory 153



Ulisse 154



Arizona 154



Mapa Max 161



Mapa Fade 162

new



MapaBianco 164



Avion 175



Multiflex 175

new



Lumiere 176



Bistrò 186



Gretel 187



Audi-10 188



Wheel 194



Hilton 195



Set Up 196

Archimede

Pag 123





Opera

Pag 198



Opera 198



Swan 199



Carlton 204



Roma 205



Millennium 212



Monet 213



Amadeus 222



Giudecca 223



Danieli 232



Brigitta 233

Interni

Indice icone



Calypso 200



King 200



Orion 201



Rain 202



Giada 202



Elisir 203



Martinez 203



Nabucco 206



Pashà 207



Luxor 208



Evasione 209



Audi-77 209



Dubai 210



Caesar 211



Pegaso 214



Blanche 216



Corte 217



Colossal 218



Rose 219



Negresco 220



Tiepolo 221



Florian 224



Napoleon 226



Gioconda 228



Impero 229



Strauss 229



Casanova 230



Doge 231



Miramare 234



Bon Bon 235



Firenze 236



Justine 237



Vanity 238



Harem 239



Chalet 240



Driftwood 241



Haunt 242



Canapa 243



Norma 244



Deca 245



Orbit **new**

Rosone e montatura in alluminio verniciato opaco. Cavi in pvc trasparenti coassiali. Diffusore in acrilico trasparente con trama incisa al laser. Finiture: bianco, nero.

LED

Sorgente luminosa LED 3000 K, 50.000 h di durata.

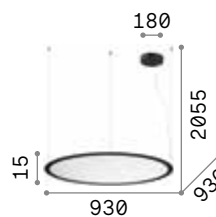
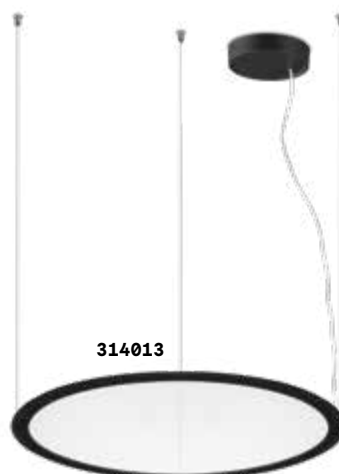

IP20

5,400 Kg / 0,1141 m³
LED 61W / 9100 lm

€ 800

328003 ■ Bianco **new** **327990** ■ Bianco **new**
314037 ■ Nero **new** **314013** ■ Nero **new**

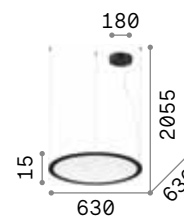

IP20

3,200 Kg / 0,0580 m³
LED 38W / 6200 lm

€ 450



Gemini ^{new}

Rosone e paralume in metallo verniciato a polveri o placcato. Diffusore in policarbonato opale. Cavo in pvc trasparente. Disponibile nelle finiture bianco, nero o ottone spazzolato. Modelli con diametro 810 mm e 610 mm disponibili anche in versione dimmerabile DALI/Push.



LED Sorgente luminosa LED 3000 K, 50.000 h di durata.

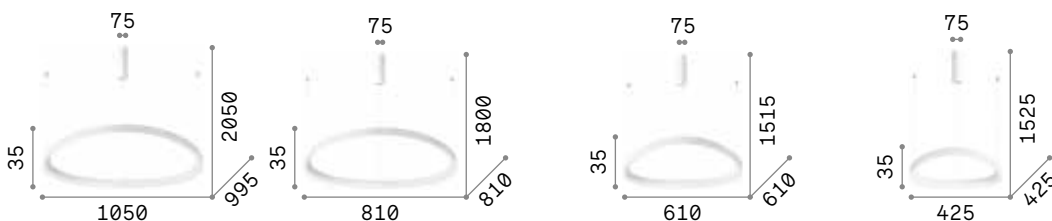
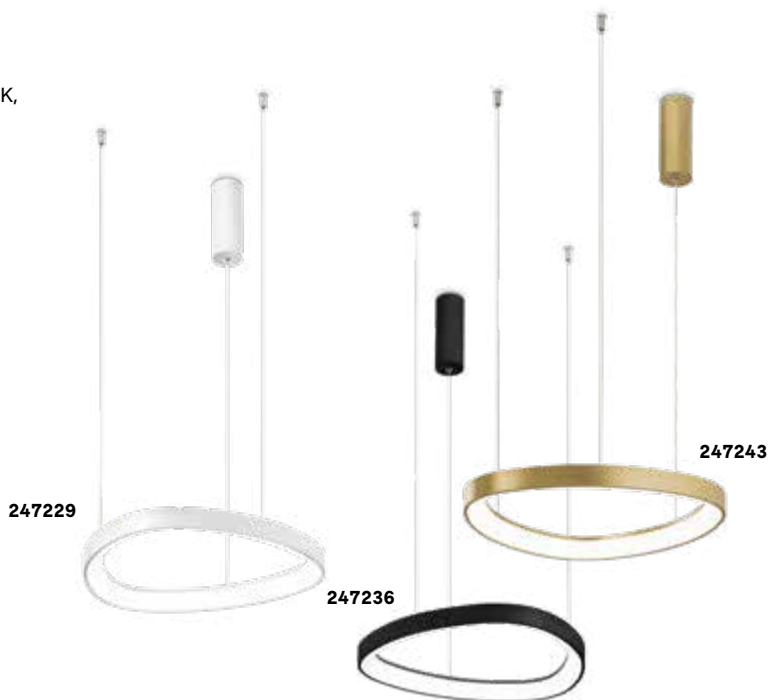

IP20

3,100 Kg / 0,1134 m³
LED 80W / 10000 lm

€ 650

303895 Bianco
307695 Nero
307701 Ottone

IP20

2,060 Kg / 0,0774 m³
LED 59W / 7600 lm

€ 430 On-Off / 525 Dali

247274 Bianco On-Off
304748 Bianco Dal/Push^{new}
247281 Nero On-Off
304724 Nero Dal/Push^{new}
269849 Ottone On-Off
304731 Ottone Dal/Push^{new}

IP20

1,710 Kg / 0,0462 m³
LED 48W / 6600 lm

€ 330 On-Off / 425 Dali

247250 Bianco On-Off
304717 Bianco Dal/Push^{new}
247267 Nero On-Off
304694 Nero Dal/Push^{new}
269832 Ottone On-Off
304700 Ottone Dal/Push^{new}

IP20

1,290 Kg / 0,0230 m³
LED 38W / 5100 lm

€ 240

247229 Bianco
247236 Nero
247243 Ottone





Oz

Base e montatura in metallo verniciato a polveri o placcato. Cavi in pvc. Diffusore in gomma opale. Finiture: bianco, nero o ottone spazzolato. Disponibile anche in versione dimmerabile DALI/Push.

LED Sorgente luminosa LED 3000 K, 30.000 h di durata.

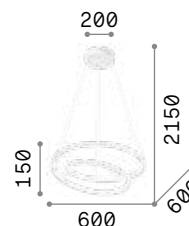
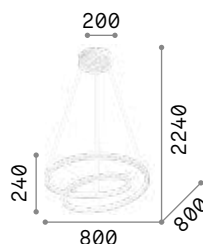

IP20

IP20

1,900 Kg / 0,0607 m³
LED 55W / 6100 lm

1,500 Kg / 0,0354 m³
LED 48W / 5300 lm

€ 390 On-Off / 500 Dali

€ 325 On-Off / 415 Dali

253664	Bianco	On-Off
304571	Bianco	Dali/Push
269450	Nero	On-Off
304588	Nero	Dali/Push
269467	Ottone	On-Off
304595	Ottone	Dali/Push

253671	Bianco	On-Off
304540	Bianco	Dali/Push
269436	Nero	On-Off
304557	Nero	Dali/Push
269443	Ottone	On-Off
304564	Ottone	Dali/Push



Crown **new**

Rosone e montatura in metallo con finitura ottone spazzolato. Cavo in pvc nero. Diffusore in acrilico opale con elemento decorativo in acrilico trasparente con effetto cristallo molato.



LED

Sorgente luminosa LED 3000 K,
30.000 h di durata.

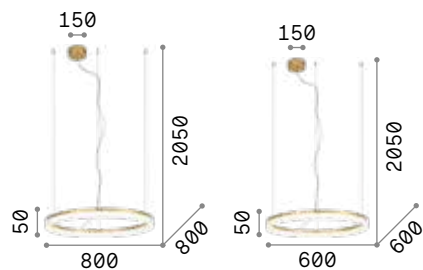

IP20

3,420 Kg / 0,0814 m³
LED 42W / 4300 lm

€ 320

314921 **Ottone** **new**

IP20

2,600 Kg / 0,0436 m³
LED 30W / 3000 lm

€ 260

314938 **Ottone** **new**

Oracle Slim Round

Lampada a sospensione costituita da una montatura sottile in alluminio verniciato bianco o nero opaco e diffusore opale in policarbonato. Disponibile in quattro dimensioni diverse. LED integrati, disponibile in temperatura di colore 3000 K e 4000 K e con controllo ON-OFF oppure dimmerabile DALI/Push, CRI ≥ 80, durata utile LED 20.000 h, protezione IP20, classe isolamento II.

Sorgente	LED SMD	Durata LED	20.000 h
Potenza	32W / 89W	Classe	II
Driver incluso	On/Off / DALI/Push	isolamento	
Driver disponibili	No	IP	20
Angolo	115°	Materiale	Alluminio
CCT	3000 K/ 4000 K		
CRI	≥80		

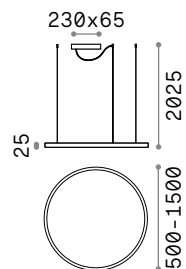

LED SMD Driver incluso

Dimensioni	Peso	Volume	Potenza	Driver	Lumen	CCT	Finitura	Codice	€	
ø 500	1,400 Kg	0,0376 m ³	32 W	On-Off	3150 lm	3000 K	Bianco	229461	200	
						3000 K	Nero	229492	200	
						3350 lm	4000 K	Bianco	269856	200
						4000 K	Nero	304380	200	
ø 700	1,100 Kg	0,0272 m ³	29 W	DALI/Push	3000 lm	3000 K	Bianco	304373	250	
						3000 K	Nero	304366	250	
						4300 lm	3000 K	Bianco	229485	245
							3000 K	Nero	229515	245
ø 900	1,200 Kg	0,0534 m ³	39 W	DALI/Push	4150 lm	4500 lm	4000 K	Bianco	269863	245
						4000 K	Nero	304410	245	
						5700 lm	3000 K	Bianco	304403	300
							3000 K	Nero	304397	300
ø 1500	2,480 Kg	0,3072 m ³	89 W	On-Off	9000 lm	3000 K	Bianco	229478	300	
						3000 K	Nero	229508	300	
						5700 lm	4000 K	Bianco	269870	300
							4000 K	Nero	304441	300
ø 1500	1,500 Kg	0,0857 m ³	43 W	DALI/Push	4600 lm	3000 K	Bianco	304434	360	
						3000 K	Nero	304427	360	
						9650 lm	3000 K	Bianco	265957	490
							3000 K	Nero	285061	490
ø 1500	2,000 Kg	0,3072 m ³	76 W	DALI/Push	7050 lm	4000 K	Bianco	285078	490	
						4000 K	Nero	304472	490	
						3000 K	Bianco	304465	600	
							Nero	304458	600	

Lunghezza cavo 2500 mm





Oracle Slim Square

Lampada a sospensione costituita da una montatura sottile in alluminio verniciato bianco o nero opaco e diffusore opale in policarbonato. Disponibile in tre dimensioni diverse. LED integrati, disponibile in temperatura di colore 3000 K e con controllo ON-OFF, CRI ≥ 80, durata utile LED 20.000 h, protezione IP20, classe isolamento II.

Sorgente	LED SMD	Durata LED	20.000 h
Potenza	33W / 53W	Classe	II
Driver incluso	On/Off	isolamento	
Driver disponibili	No	IP	20
Angolo	115°	Materiale	Alluminio
CCT	3000 K		
CRI	≥80		



LED SMD Driver ON/OFF incluso

Dimensioni	Peso	Volume	Potenza	Driver	Lumen	CCT	Finitura	Codice	€
500x500	1,730 Kg	0,0422 m³	33 W	On-Off	3300 lm	3000 K	Bianco	259154	210
							Nero	259161	210
700x700	2,000 Kg	0,0819 m³	41 W	On-Off	4350 lm	3000 K	Bianco	259178	255
							Nero	259185	255
900x900	2,100 Kg	0,1317 m³	53 W	On-Off	5250 lm	3000 K	Bianco	259192	310
							Nero	259208	310

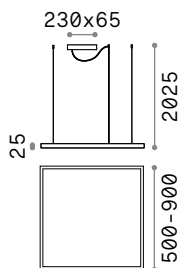

Lunghezza cavo 2500 mm



Oracle

Rosone e corpo luce in alluminio verniciato a polveri di colore bianco o nero. Diffusore in materiale plastico color opale. Sorgente luminosa a led integrati.

LED Sorgente luminosa LED 3000 K, 30.000 h di durata.

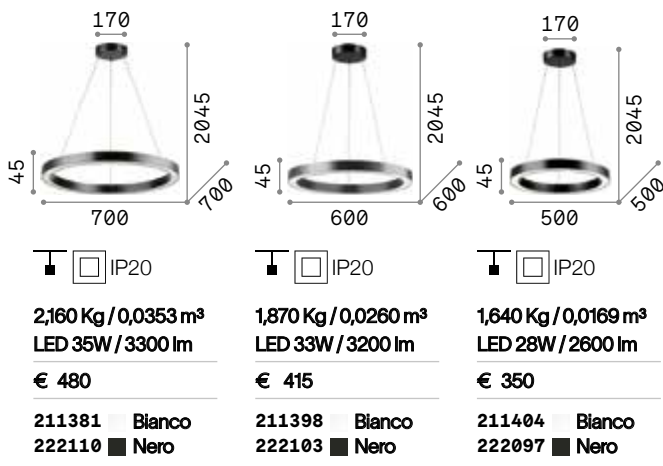

Hulahoop

Rosone e montatura in metallo verniciato a polveri con finitura bianca. Diffusore in gomma opale. Cavi in acciaio con supporti a soffitto. Cavo elettrico in pvc trasparente.

LED Sorgente luminosa LED 3000 K, 17.500 h di durata.

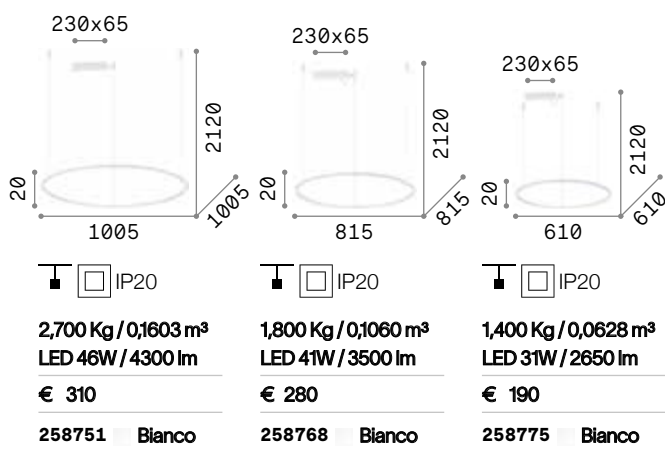



Circus

Rosone e montatura in metallo verniciato a polveri con finitura nera Diffusore esterno in policarbonato opale. Cavo elettrico in PVC.

LED Sorgente luminosa LED 3000 K, 20.000 h di durata.

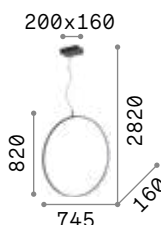

IP20

1,130 Kg / 0,0593 m³
LED 36W / 4250 lm

€ 290

291406 ■ Nero

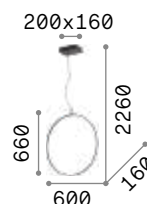

IP20

1,060 Kg / 0,0384 m³
LED 33W / 3550 lm

€ 255

291376 ■ Nero

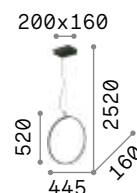

IP20

0,970 Kg / 0,0221 m³
LED 29W / 3200 lm

€ 220

291345 ■ Nero



Frame

Base e montatura in metallo verniciato bianco opaco o nero opaco. Diffusori in materiale plastico colore opale. Cavi regolabili in lunghezza. Emissione luce diretta.

LED Sorgente luminosa LED 3000 K, 30.000 h di durata.

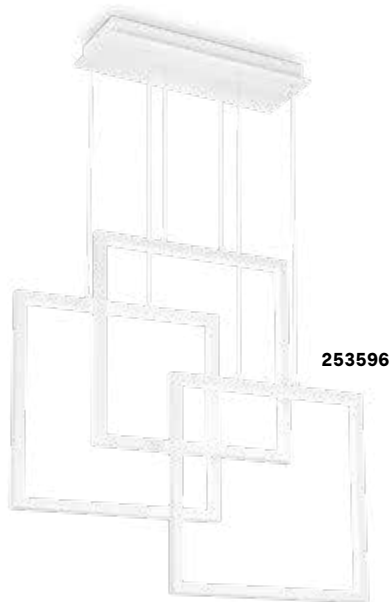
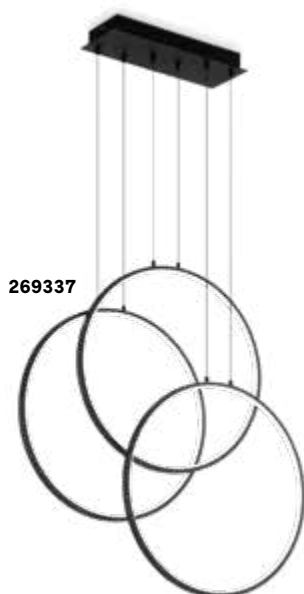

IP20	IP20	IP20
3,500 Kg / 0,1050 m³ LED 82W / 7300 lm	4,270 Kg / 0,0689 m³ LED 80W / 9100 lm	4,300 Kg / 0,2100 m³ LED 93W / 10700 lm
€ 355	€ 555	€ 550
269351 ■ Bianco 269337 ■ Nero	253596 ■ Bianco 269375 ■ Nero	253589 ■ Bianco 269382 ■ Nero



P. 254



P. 528



074

Look new

Rosone e diffusore in metallo con varie finiture. Cavo in tessuto regolabile in lunghezza. Monta lampadine sostituibili. Modello con finitura cromo sfumato con diffusore in vetro.

LED Lampadine LED GU10 7W e GU10 10W 3000 K incluse.



104935 104942 104928 141800 313894 141817 259239 141794 141855 170589

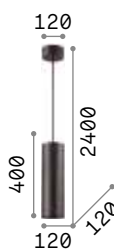

2,950 Kg / 0,0092 m³
GU10 max 1x 50W

€ 132

158723 ■ Nero

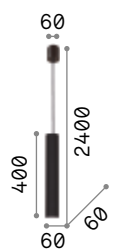

0,990 Kg / 0,0029 m³
GU10 max 1x 28W

€ 72

104935 ■ Bianco
104942 ■ Cromo
104928 ■ Nero

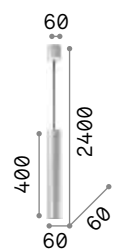

0,990 Kg / 0,0029 m³
GU10 max 1x 28W

€ 95

194806 ■ Trasparen.
141800 ■ Argento
313894 ■ Nickel new
141817 ■ Oro
259239 ■ Ottone
141794 ■ Brunito
141855 ■ Rame
170589 ■ Coffee



3000 K
800 lm

189031

€ 15,00



3000 K
540 lm

123943

€ 3,50



3000 K
540 lm

123943

€ 3,50



P. 310



P. 393



P. 534



P. 708

Tube

Rosone e corpo luce in alluminio verniciato a polveri di colore bianco o nero. Cavo in tessuto. Sorgente luminosa a led integrati.

LED Sorgente luminosa LED 3000 K, 35.000 h di durata.

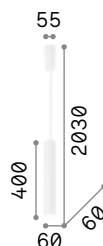

IP20

0,960 Kg / 0,0073 m³
LED 11W / 1200 lm

€ 210

211701 Bianco
211718 Nero

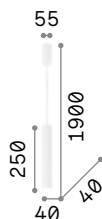

IP20

0,680 Kg / 0,0048 m³
LED 11W / 1200 lm

€ 150

211459 Bianco
211466 Nero



Oak

Rosone in metallo rifinito con vernice opaca. Diffusore in cemento. Cavo in tessuto nero.

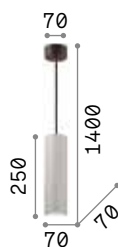

IP20

1,220 Kg / 0,0055 m³
GU10 max 1x35W

€ 85

150635 Cemento

3000 K
410 lm
108292 € 3,00

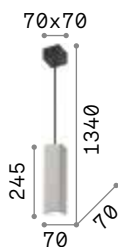

IP20

1,720 Kg / 0,0055 m³
GU10 max 1x35W

€ 85

150673 Cemento

3000 K
410 lm
108292 € 3,00



P. 318





Sky

Rosone e diffusore in metallo placcato o rifinito con vernice opaca bianco o nero.

LED Lampadine LED GU10 7W 3000 K incluse. Cod. **123943**



126906 126913 259017

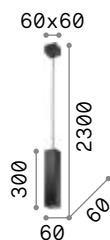

0,950 Kg / 0,0043 m³
GU10 max 1x28W

€ 96

126906 Bianco
126913 Nero
259017 Ottone

3000 K
540 lm
123943 € 3,50



078

Filo **new**

Base e corpi luci in metallo verniciato a polveri o placcato. Cavi elettrici in pvc nero. Colori: bianco, nero oppure ottone satinato. Modelli 300801, 300818 e 300825 disponibile come 4 metri di cavo.

LED Sorgente luminosa LED 3000 K, 20.000 h di durata.

263687

263670

263700

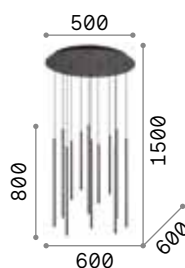

8,600 Kg / 0,1232 m³
LED 25W / 3150 lm

€ 690

263441 Bianco
263434 Nero
263663 Ottone

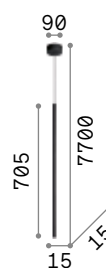

0,830 Kg / 0,0105 m³
LED 4W / 160 lm

€ 180

300818 Bianco **new**
300801 Nero **new**
300825 Ottone **new**

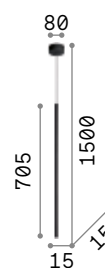

0,530 Kg / 0,0142 m³
LED 3,5W / 230 lm

€ 125

263687 Bianco
263670 Nero **new**
263700 Ottone **new**



080

Ultrathin new

Rosone e diffusore in metallo placcato cromo o rifinito con vernice opaca bianco o nero. Cavo elettrico in tessuto. Modello round nero disponibile anche in versione dimmerabile DALI/Push.

LED Sorgente luminosa LED 3000 K, 20.000 h di durata.



142913 321783
156699 321813

194196, 194202

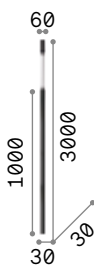

0,670 Kg / 0,0036 m³
LED 11,5W / 1150 lm / 51°

€ 130 On-Off / 185 Dali

142906	Bianco	On-Off
164878	Cromo	On-Off
142913	Nero	On-Off
321783	Nero	Dali/Push ^{new}

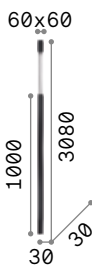

0,860 Kg / 0,0036 m³
LED 11,5W / 1150 lm / 51°

€ 190

194172	Bianco	
194196	Nero	

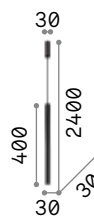

0,460 Kg / 0,0036 m³
LED 11,5W / 1150 lm / 51°

€ 98 On-Off / 160 Dali

156682	Bianco	On-Off
187662	Cromo	On-Off
156699	Nero	On-Off
321813	Nero	Dali/Push ^{new}

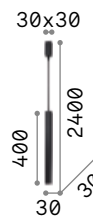

0,450 Kg / 0,0019 m³
LED 11,5W / 1150 lm / 51°

€ 155

194189	Bianco	
194202	Nero	



Essence

Rosone e corpo luce in alluminio verniciato a polveri. Diffusore in materiale acrilico opale. Cavi in pvc. Colori: bianco o nero.

LED Sorgente luminosa LED 3000 K, 30.000 h di durata.

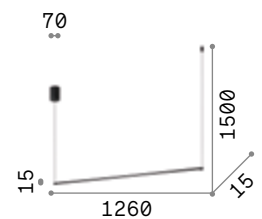
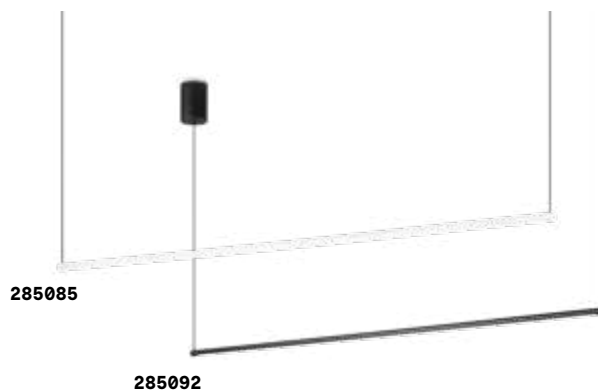

IP20

0,900 Kg / 0,0165 m³
LED 20W / 2650 lm

€ 275

285085 ■ Bianco
285092 ■ Nero



P. 402

Yoko

Rosone, montatura e supporto per il cavo in metallo verniciato opaco. Diffusore in policarbonato opale. Cavo in pvc trasparente. Colori: bianco o nero.

LED Sorgente luminosa LED 3000 K, 30.000 h di durata.

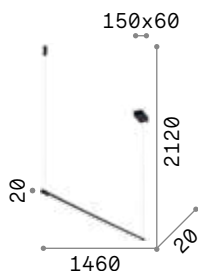

IP20

0,700 Kg / 0,0383 m³
LED 16W / 1450 lm

€ 130

258898 ■ Bianco
258928 ■ Nero



P. 473



P. 531



V-Line

Corpo luce in alluminio verniciato a polveri o placcato. Diffusore in silicone opale. Cavi d'acciaio con supporti cromati. Cavo elettrico in pvc. Colori: bianco, nero oppure ottone spazzolato.

LED Sorgente luminosa LED 3000 K, 20.000 h di durata.

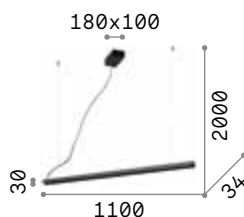

IP20

1,050 Kg / 0,0058 m³
LED 20W / 1800 lm

€ 215

275369 ■ Bianco
275376 ■ Nero
275383 ■ Ottone





Desk

Corpo luce e rosone in alluminio rifinito con vernice a polveri color bianco o nero opaco. Sospensione con cavi elettrici regolabili in lunghezza.

LED Sorgente luminosa LED 3000 K, 30.000 h di durata.



138237



173245

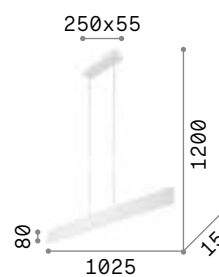

 IP20

1,860 Kg / 0,0140 m³
LED 32W / 2100 lm

€ 290

138237 ■ Bianco
173245 ■ Nero



P. 386



Craft

Rosone in metallo verniciato nero opaco. Corpo luce in legno naturale. Diffusore in policarbonato opale satinato. Cavo in PVC trasparente.

LED Sorgente luminosa LED 3000 K, 20.000 h di durata.

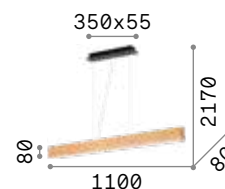

IP20

3,400 Kg / 0,0238 m³
LED 37W / 4600 lm

€ 360

284460 ■ Legno



P. 386



P. 538



Karousel

Montatura in metallo rifinito in ottone satinato. Diffusori in vetro incamiciato bianco, soffiato e acidato.

LED Lampadine LED G9 4W 3000 K incluse.
Cod. **209043**



IP20	IP20
4,340 Kg / 0,1739 m³ G9 max 10 x 15W	2,810 Kg / 0,1055 m³ G9 max 6 x 15W
€ 780	€ 520
206394 Ottone	206387 Ottone
3000 K 510 lm	3000 K 510 lm
305486 € 6,00	305486 € 6,00



Rhapsody

Montatura in metallo con rosone rifinito ottone satinato e bracci nero opaco. Cavi in pvc. Diffusori in vetro soffiato bianco acidato.

LED Lampadine LED G9 4W 3000 K incluse.
Cod. **209043**

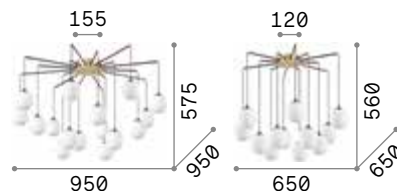

IP20 INCLUSA

5,020 Kg / 0,2040 m³
G9 max 16 x 15W

€ 750

236964 ■ Nero

3000 K
510 lm

305486 € 6,00

IP20 INCLUSA

3,510 Kg / 0,1400 m³
G9 max 12 x 15W

€ 550

236957 ■ Nero

3000 K
510 lm

305486 € 6,00



Lucciola

Rosone e corpo luce sospeso in metallo verniciato a polveri o placcato. Diffusore sferico in acrilico satinato. Cavi in pvc con supporti a soffitto in alluminio. Colore: ottone o nero.

LED Sorgente luminosa LED 3000 K, 20.000 h di durata.



284002 284019

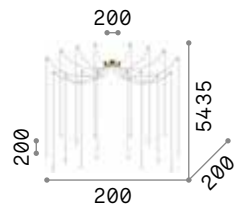

IP20

2,500 Kg / 0,0165 m³
LED 16W / 1300 lm

€ 500

284002 ■ Nero
284019 ■ Ottone

Fish

Rosone, asta e diffusore in metallo verniciato nero opaco. Cavo in acciaio con supporto in metallo cromato. Led integrato con schermo opale.

LED Sorgente luminosa LED 3000 K, 20.000 h di durata.

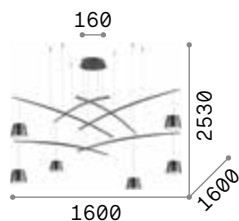

IP20

6,790 Kg / 0,0377 m³

LED 37W / 2800 lm

€ 670

196992 ■ Nero



Pop

Rosone, montatura e copri portalampade in metallo rifinito con vernice opaca nera. Cavi regolabili in lunghezza.

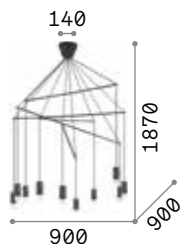

IP20

2,920 Kg / 0,0147 m³

E27 max 10 x 60W

€ 300

158860 ■ Nero

3000 K
900 lm

123899 € 6,00

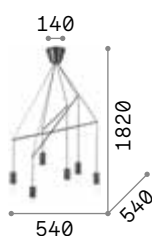

IP20

1,670 Kg / 0,0096 m³

E27 max 6 x 60W

€ 200

158815 ■ Nero

3000 K
900 lm

123899 € 6,00





Dynamite

Montatura in metallo rifinito con vernice a polveri o placcato e spazzolato. Diffusori orientabili. Cavo elettrico in tessuto. Sospensioni con incluso kit per installazione anche a plafone.

LED

Lampadine LED GU10 7W 3000 K incluse. Cod. **123943**



231433

231396

244648



P. 320

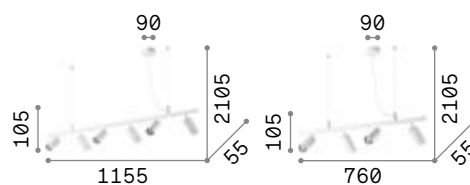

2,700 Kg / 0,0360 m³
GU10 max 6 x 28W

€ 350

231433 Bianco
231396 Nero
244648 Ottone

3000 K
540 lm

123943 € 3,50



2,310 Kg / 0,0243 m³
GU10 max 4 x 28W

€ 275

231372 Bianco
231341 Nero
244624 Ottone

3000 K
540 lm

123943 € 3,50



Minor

Montatura in metallo verniciato a polveri. Cavo elettrico in pvc. Sorgenti luminose a LED sostituibili.

LED Lampadine LED GX53 9W 3000 K incluse. Cod. **123936**

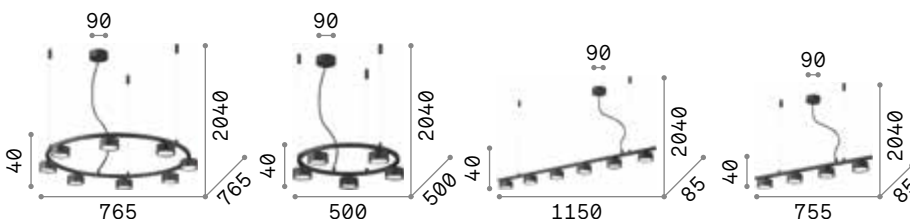

3,440 Kg / 0,1200 m³
GX53 max 8 x 15W

€ 480

235547 ■ Nero

3000 K
910 lm

123936 € 5,50



2,250 Kg / 0,0564 m³
GX53 max 5 x 15W

€ 325

235516 ■ Nero

3000 K
910 lm

123936 € 5,50



2,210 Kg / 0,0203 m³
GX53 max 6 x 15W

€ 325

235486 ■ Nero

3000 K
910 lm

123936 € 5,50



1,650 Kg / 0,0135 m³
GX53 max 4 x 15W

€ 247

235455 ■ Nero

3000 K
910 lm

123936 € 5,50





Triumph

Base, bracci e copri porta lampade in metallo con finitura nero opaco o ottone invecchiato.



242347



160269

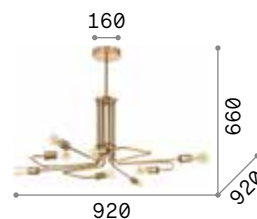

IP20

3,640 Kg / 0,0470 m³
E27 max 8 x 60W

€ 550

242347 ■ Nero
160269 ■ Ottone

2200 K
370 lm

151687 € 4,60



Abc

Rosone, copri portalamapade e struttura decorativa interamente in metallo rifinito ottone satinato. Cavo in tessuto nero.

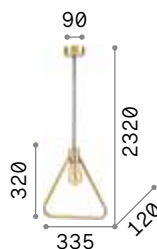

0,590 Kg / 0,0117 m³
E27 max 1x70W

€ 120

207834 ■ Ottone

2200 K
440 lm
151694 € 6,00

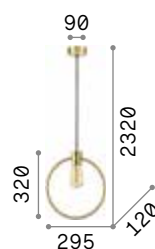

0,570 Kg / 0,0100 m³
E27 max 1x70W

€ 120

207841 ■ Ottone

2200 K
330 lm
151700 € 4,60

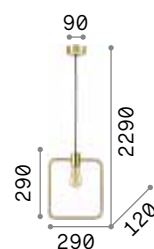

0,610 Kg / 0,0100 m³
E27 max 1x70W

€ 120

207858 ■ Ottone

2200 K
500 lm
151717 € 8,00



Lingotto new

Montatura in metallo verniciato: base nera opaca e telaio ottone opaco oppure completamente nero opaco. Diffusori in vetro incamiciato bianco, soffiato e acidato.

LED

Lampadine LED G9 4W 3000 K incluse nei modelli: **327846**, **251110**, **327839** e **251103**. Cod. **209043**



P. 345



P. 497

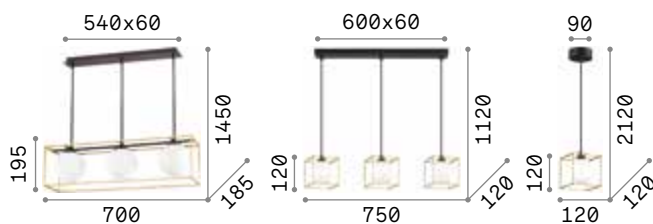

IP20

4,530 Kg / 0,0564 m³

E14 max 3 x 28W

€ 290

304144 **Nero** new
198125 **Ottone**

3000 K
420 lm

101217 € 2,50

IP20

2,260 Kg / 0,0442 m³

G9 max 3 x 28W

€ 240

327846 **Nero** new
251110 **Ottone**

3000 K
510 lm

305486 € 6,00

IP20

0,660 Kg / 0,0105 m³

G9 max 1 x 28W

€ 90

327839 **Nero** new
251103 **Ottone**

3000 K
510 lm

305486 € 6,00



Igor

Montatura in metallo rifinito con vernice opaca nera. Diffusore con lastre di vetro trasparente.

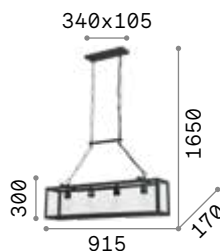

IP20

8,810 Kg / 0,0941 m³
E27 max 4 x 60W

€ 390

092942 ■ Nero

2200 K
440 lm
151694 € 6,00

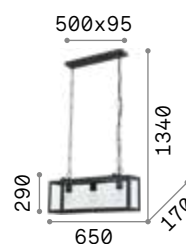

IP20

7,100 Kg / 0,0682 m³
E27 max 3 x 60W

€ 300

092881 ■ Nero

2200 K
440 lm
151694 € 6,00

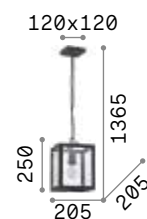

IP20

2,600 Kg / 0,0281 m³
E27 max 1 x 60W

€ 150

092850 ■ Nero

2200 K
440 lm
151694 € 6,00



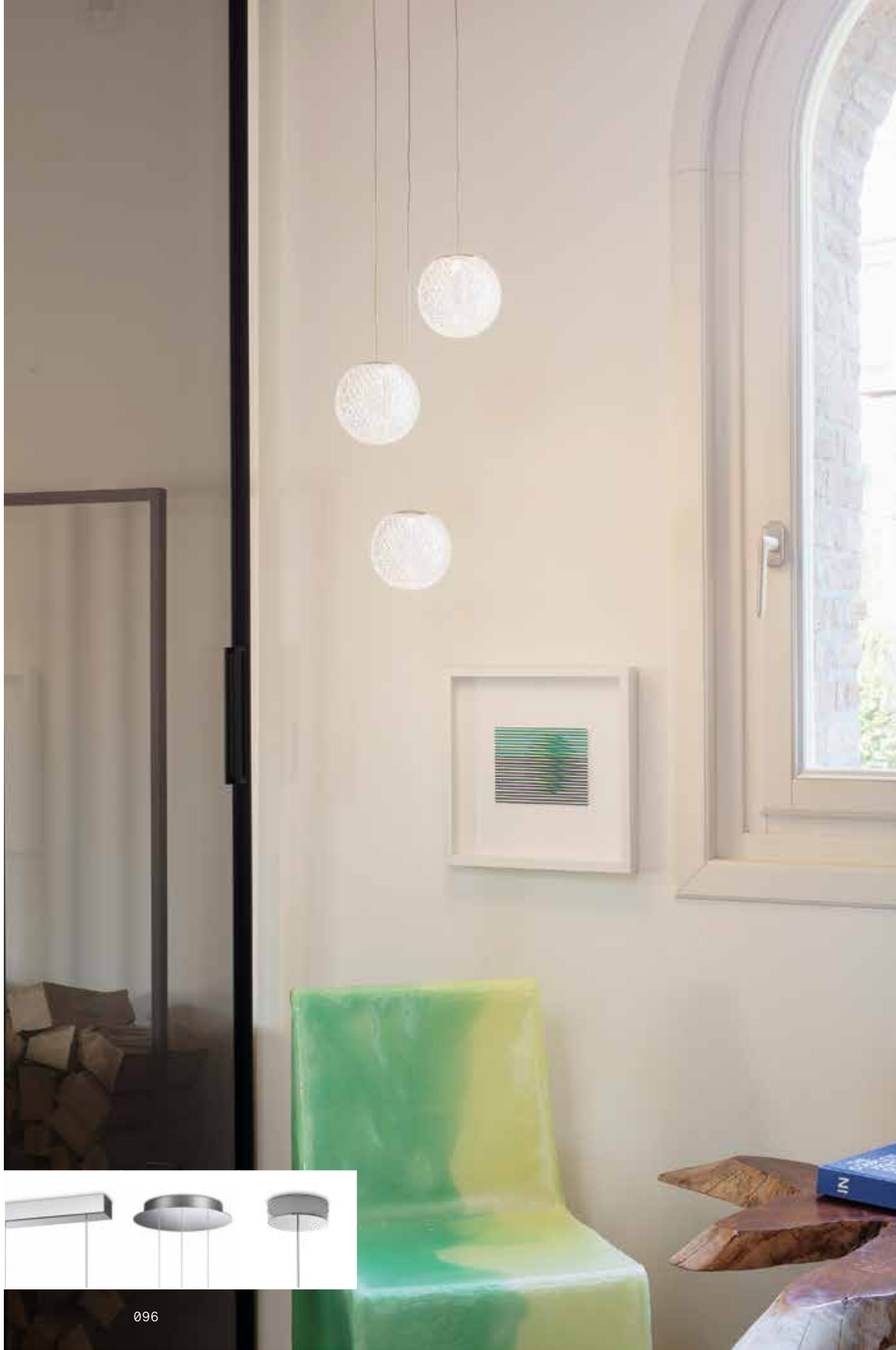

Diamond **new**

Rosone in metallo cromato. Cavo in teflon trasparente. Diffusori in acrilico trasparente con lavorazione ad effetto cristallo molato.

LED Sorgente luminosa LED 3000 K, 30.000 h di durata.



IP20	IP20	IP20
2,730 Kg / 0,0276 m³ LED 27W / 2750 lm	1,860 Kg / 0,0181 m³ LED 15W / 1750 lm	0,560 Kg / 0,0044 m³ LED 6,5W / 650 lm
€ 350	€ 210	€ 85
305325 Trasparen.new	305295 Trasparen.new	305288 Trasparen.new





Galaxy **new**

Rosone in metallo rifinito nichel nero lucido. Cavi in pvc nero. Diffusori in acrilico opale e trasparente, con inserti centrali in metallo spazzolato color nichel, ottone e rame.

LED Sorgente luminosa LED 3000 K, 30.000 h di durata.

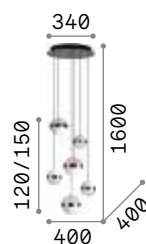

IP20

5,500 Kg / 0,0540 m³
LED 56W / 5750 lm

€ 650

321172 **Bianco** **new**

Birds

Montatura in metallo verniciato con disco decorativo in ottone satinato. Diffusori in vetro soffiato bianco acidato. Cavo in pvc. Colore: nero opaco con dettaglio ottone satinato.

LED Lampadine LED G9 4W 3000 K incluse.
Cod. **209043**

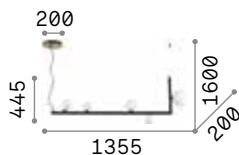

IP20

2,750 Kg / 0,1353 m³

G9 max 5 x 15W

€ 283

273648 ■ Nero

3000 K
510 lm

305486 € 6,00



P. 337 P. 433 P. 494 P. 522



Perline

Rosone e montatura in metallo. Diffusori in vetro incamiciato bianco, soffiato e acidato. Cavo elettrico in teflon trasparente. Finiture: nero opaco oppure ottone satinato.

LED Lampadine LED G9 4W 3000 K incluse.
Cod. **209043**

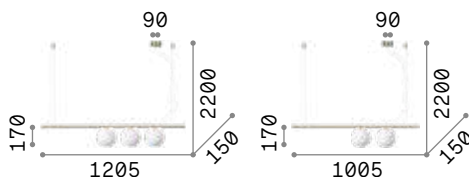

IP20

1,600 Kg / 0,0584 m³
G9 max 3 x 40W

€ 215

307008 ■ Nero
282114 ■ Ottone

3000 K
510 lm

305486 € 6,00

IP20

1,200 Kg / 0,0546 m³
G9 max 2 x 40W

€ 155

306995 ■ Nero
282107 ■ Ottone

3000 K
510 lm

305486 € 6,00



306995

282107



P. 334 P. 435 P. 495 P. 524

Perlage **new**

Montatura in metallo con struttura lineare a sezione tonda o circolare a sezione quadrata. Diffusori in vetro soffiato. Cavi in acciaio gommati. Cavo elettrico in pvc. Finiture: nero opaco e vetri pirex fumé oppure ottone satinato con vetri bianchi acidati o con vetri ambra.

LED Lampadine LED G9 4W 3000 K incluse.
Cod. **209043**



283821



271422



317793

8,920 Kg / 0,2722 m ³ G9 max 30 x 15W	3,910 Kg / 0,0924 m ³ G9 max 14 x 15W	3,100 Kg / 0,0736 m ³ G9 max 11 x 15W	2,200 Kg / 0,0617 m ³ G9 max 10 x 15W	1,300 Kg / 0,0317 m ³ G9 max 6 x 15W
€ 1400	€ 620	€ 530	€ 390	€ 260
296746 Bianco 296753 Fumè 322780 Ambra new	283814 Bianco 271385 Fumè 322797 Ambra new	283807 Bianco 271392 Fumè 322773 Ambra new	283791 Bianco 271408 Fumè 322766 Ambra new	283821 Bianco 271422 Fumè 317793 Ambra new
3000 K 510 lm 305486 € 6,00	3000 K 510 lm 305486 € 6,00	3000 K 510 lm 305486 € 6,00	3000 K 510 lm 305486 € 6,00	3000 K 510 lm 305486 € 6,00



Equinoxe new

Montatura in metallo con finitura cromo o ottone antico. Diffusori in vetro soffiato trasparente.

LED Lampadine LED G4 2W 3000 K incluse.
Cod. 222257



200118



200125

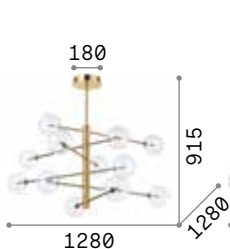

5,540 Kg / 0,1304 m³
G4 max 12 x 2W

€ 950

200118 Cromo
200125 Ottone

3000 K
200 lm

222257 € 4,00

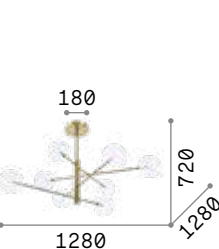

4,460 Kg / 0,1427 m³
G4 max 8 x 2W

€ 750

275178 Cromo
275215 Ottone

3000 K
200 lm

222257 € 4,00

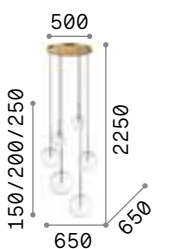

5,200 Kg / 0,1274 m³
G4 max 6 x 2W

€ 650

317250 Cromo
317243 Ottone

3000 K
200 lm

222257 € 4,00

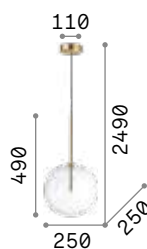

0,850 Kg / 0,0326 m³
G4 max 1 x 2W

€ 180

306551 Cromo
277394 Ottone

3000 K
200 lm

222257 € 4,00

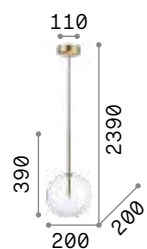

0,700 Kg / 0,0211 m³
G4 max 1 x 2W

€ 140

306544 Cromo
277387 Ottone

3000 K
200 lm

222257 € 4,00

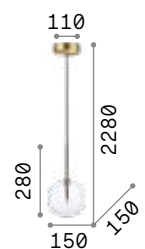

0,640 Kg / 0,0170 m³
G4 max 1 x 2W

€ 120

306537 Cromo
277370 Ottone

3000 K
200 lm

222257 € 4,00



Copernico

Montatura in metallo verniciato bianco o nero opaco con dettagli in ottone. Diffusori in vetro incamiciato bianco soffiato e acidato.

LED

Lampadine LED G9 4W 3000 K incluse.
Cod. 209043



197302



197319

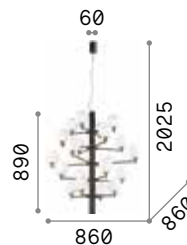

IP20

10,270 Kg / 0,1340 m³
G9 max 20 x 40W

€ 1050

197326 ■ Bianco
197333 ■ Nero

3000 K
510 lm
305486 € 6,00

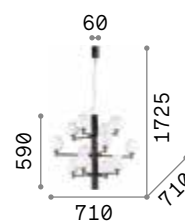

IP20

6,870 Kg / 0,0970 m³
G9 max 12 x 40W

€ 650

197302 ■ Bianco
197319 ■ Nero

3000 K
510 lm
305486 € 6,00

Kepler

Catena e montatura in metallo verniciato nero opaco. Diffusori in vetro soffiato trasparente ambrato.

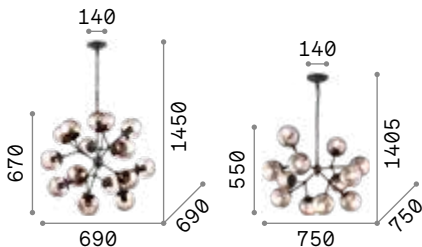

IP20

5,300 Kg / 0,1789 m³
E27 max 18 x 40W

€ 400

162478 ■ Nero

3000 K
430 lm
101279 € 2,60

IP20

3,630 Kg / 0,0990 m³
E27 max 12 x 40W

€ 300

162201 ■ Nero

3000 K
430 lm
101279 € 2,60



P. 434



Spark

Rosone e montatura in metallo verniciato nero opaco con portalampade placcati. Cavo elettrico rivestito in tessuto.

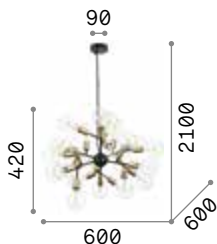

IP20

3,000 Kg / 0,0885 m³
E27 max 24 x 25W

€ 500

238241 ■ Nero

3000 K
1120 lm
101323 € 7,00



P. 342



Leaves

Montatura in metallo bianco.
Elementi decorativi in vetro soffiato
bianco e modellato a mano. Cavi
d'acciaio regolabili in lunghezza.

LED Lampadine LED G9 4W 3000 K incluse.
Cod. **209043**

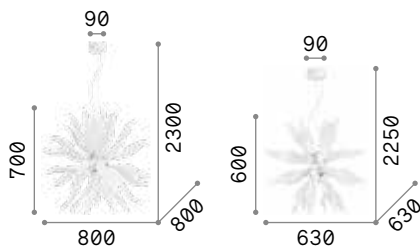

5,800 Kg / 0,1123 m³
G9 max 12 x 40W

€ 880

112268 Bianco

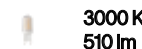

305486 € 6,00



3,700 Kg / 0,0702 m³
G9 max 8 x 40W

€ 580

111957 Bianco

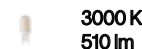

305486 € 6,00



Vortex

Montatura in metallo verniciato
bianco opaco. Elementi decorativi in
metallo modellato artigianalmente
e dipinti a mano con oro o argento.

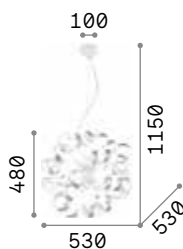

2,500 Kg / 0,2344 m³
E14 max 6 x 40W

€ 250

101613 Argento
101606 Oro

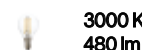

101200 € 2,50



101613



101606





Net new

Rosone in metallo verniciato opaco.
Cavo in pvc. Diffusore in rete
metallica verniciata opaca. Finiture:
bianco, nero, oro.

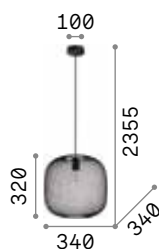

0,950 Kg / 0,0518 m³
E27 max 1x42W

€ 65

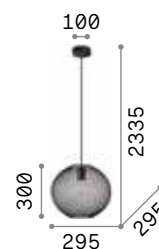

0,750 Kg / 0,0342 m³
E27 max 1x42W

€ 55

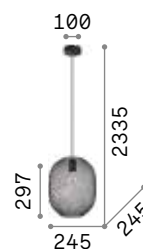

0,750 Kg / 0,0281 m³
E27 max 1x42W

€ 55



328102



313788



313771

328133	Bianco	new	328102	Bianco	new	317274	Bianco	new
328126	Nero	new	313788	Nero	new	328119	Nero	new
317281	Oro	new	313771	Oro	new	317267	Oro	new

3000 K
900 lm
123899 € 6,00

3000 K
900 lm
123899 € 6,00

3000 K
900 lm
123899 € 6,00



Disco

Montatura con elementi decorativi circolari rotanti e posizionabili a piacere. Disponibile in metallo verniciato in bianco o nero opaco oppure in legno naturale sagomato.



138275



103723



114262



IP20

1,240 Kg / 0,0447 m³
E27 max 1x 60W

€ 220

138275 ■ Legno

3000 K
950 lm

101330 € 7,50

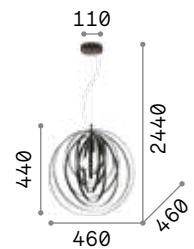

IP20

2,660 Kg / 0,0365 m³
E27 max 1x 60W

€ 260

103723 ■ Bianco
114262 ■ Nero

3000 K
950 lm

101330 € 7,50



Konse

Montatura ed elementi decorativi interamente in metallo. Finitura con vernice oro scuro satinato.

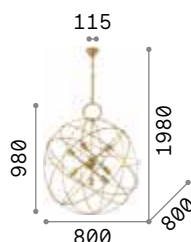

IP20

4,600 Kg / 0,7203 m³
E27 max 7 x 60W

€ 650

156033 Oro

3000 K
910 lm
119571 € 6,00

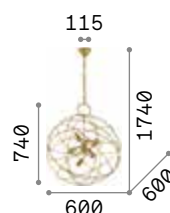

IP20

3,510 Kg / 0,1201 m³
E27 max 6 x 60W

€ 450

156026 Oro

3000 K
910 lm
119571 € 6,00

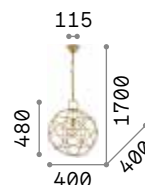

IP20

1,930 Kg / 0,1175 m³
E27 max 1 x 60W

€ 225

155968 Oro

3000 K
910 lm
119571 € 6,00



Ampolla

Rosone porta lampade e struttura decorativa in metallo con finitura bianco e nero. Cavo elettrico regolabile in lunghezza.



200903



167497

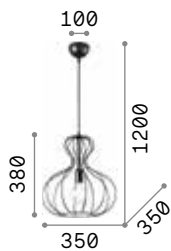

0,950 Kg / 0,0709 m³
E27 max 1x60W

€ 120

194295 Bianco
148502 Nero

2200 K
500 lm

151717 € 8,00

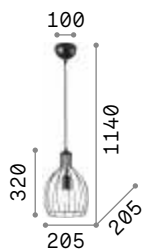

0,590 Kg / 0,0480 m³
E27 max 1x60W

€ 110

200880 Bianco
148151 Nero

2200 K
370 lm

151687 € 4,60

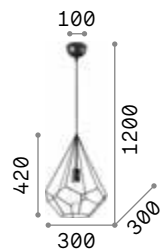

0,720 Kg / 0,0480 m³
E27 max 1x60W

€ 198

200897 Bianco
148175 Nero

2200 K
440 lm

151694 € 6,00

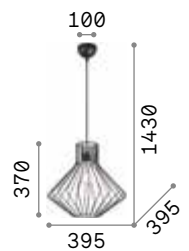

1,470 Kg / 0,0709 m³
E27 max 1x60W

€ 214

200903 Bianco
167497 Nero

2200 K
440 lm

151694 € 6,00



Onion

Struttura in metallo con finitura in vernice marrone ad effetto metallico. Cavo in tessuto.



IP20

5,050 Kg / 0,2383 m³
E27 max 1x60W

€ 400

205311 ■ Coffee

2200 K
480 lm

151724 € 8,00

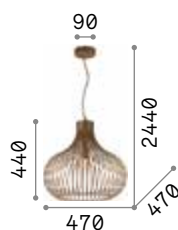

IP20

3,520 Kg / 0,1325 m³
E27 max 1x60W

€ 270

205304 ■ Coffee

2200 K
480 lm

151724 € 8,00

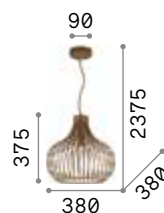

IP20

2,380 Kg / 0,0705 m³
E27 max 1x60W

€ 180

205298 ■ Coffee

2200 K
500 lm

151717 € 8,00

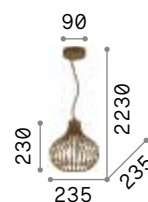

IP20

1,260 Kg / 0,0169 m³
E27 max 1x60W

€ 95

205281 ■ Coffee

2200 K
500 lm

151717 € 8,00



Ice

Rosone e montatura in metallo verniciato bianco o nero opaco. Copri porta lampade in metallo rifinito ottone satinato. Cavo elettrico in pvc.

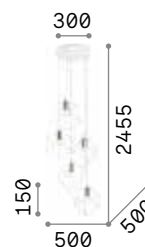

IP20

2,920 Kg / 0,0345 m³
E27 max 5 x 60W

€ 230

237671 ■ Bianco
237664 ■ Nero

3000 K
340 lm

101286 € 2,60



237671



237664

Citrus

Corpo luce con elementi multistrato di legno verniciato. Cavo in tessuto nero.

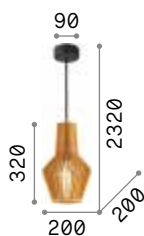

0,660 Kg / 0,0173 m³
E27 max 1x60W

€ 152

159843 Legno

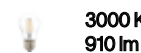

119571 € 6,00



0,720 Kg / 0,0242 m³
E27 max 1x60W

€ 160

159850 Legno

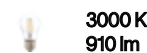

119571 € 6,00

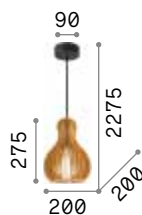

0,510 Kg / 0,0148 m³
E27 max 1x60W

€ 135

159867 Legno

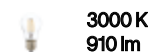

119571 € 6,00



Lugano

Rosone in metallo verniciato opaco. Cavo in tessuto con portalampade in metallo brunito. Diffusore in ceramica.

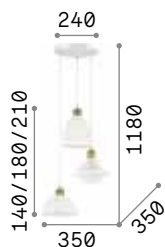

2,950 Kg / 0,0618 m³
E27 max 3x60W

€ 385

206875 Bianco

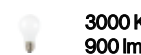

123899 € 6,00

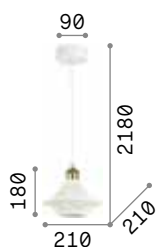

0,850 Kg / 0,0090 m³
E27 max 1x60W

€ 138

206806 Bianco

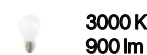

123899 € 6,00

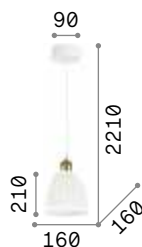

0,860 Kg / 0,0068 m³
E27 max 1x60W

€ 138

206820 Bianco

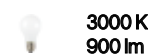

123899 € 6,00



Frida

Rosone e copriportalampada in metallo con finitura placcata o in vernice opaca. Cavo in tessuto nero.

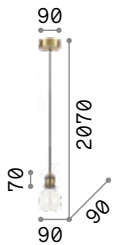

0,320 Kg / 0,0015 m³
E27 max 1x60W

€ 40

- 139432 Cromo
- 139425 Nero
- 122106 Rame
- 122083 Brunito

2200 K
500 lm

151717 € 8,00 [P. 431](#)



Doc

Rosone e copriportalampada in metallo con finiture varie. Cavo in tessuto nero. Interruttore incorporato al portalampada.

Lampada con interruttore integrato.

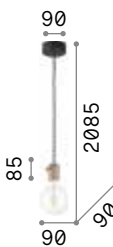

0,220 Kg / 0,0015 m³
E27 max 1x60W

€ 55

- 163123 Rame
- 163154 Ottone
- 163109 Brunito
- 163161 Piombo

2200 K
330 lm

223933 € 8,00





Edison

Rosone e copri porta lampada in metallo rifinito con vernice opaca bianca o nera. Cavo elettrico in tessuto.

LED

Lampadine LED E27 8W Globo D125 trasparente 3000 K incluse.
Cod. **101347**

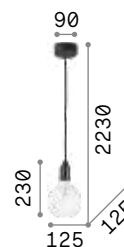

0,320 Kg / 0,0098 m³
E27 max 1x 60W

€ 67

113302 ■ Bianco
113319 ■ Nero

3000 K
1020 lm

101347 € 8,00



P. 428



Minimal

Montatura in metallo rifinito in smalto colorato. Cavo elettrico con rivestimento in tessuto. Sospensioni SPLI fornite con due metri di cavo.

LED Lampadine LED E27 8W Globo D125 trasparente 3000 K incluse. Cod. **101347**

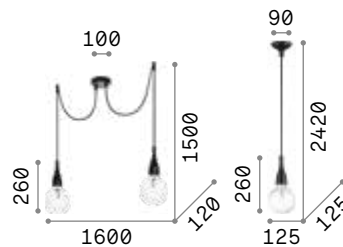

IP20

0,900 Kg / 0,0171 m³
E27 max 2 x 60W

€ 127

112718 Bianco
112671 Nero

3000 K
1020 lm

101347 € 8,00

IP20

0,470 Kg / 0,0099 m³
E27 max 1 x 70W

€ 66

009360 Bianco
009407 Nero

3000 K
1020 lm

101347 € 8,00



P. 430



Mr Jack

Montatura e diffusore sferico in metallo rifinito in bianco, cromo o nero. Cavo elettrico rivestito in tessuto.

LED Lampadine LED GU10 7W 3000 K incluse. Cod. **123943**

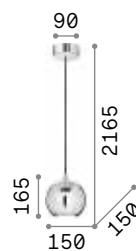

0,890 Kg / 0,0090 m³
GU10 max 1x28W

€ 80

231273 Bianco
116464 Cromo
231297 Nero

3000 K
540 lm

123943 € 3,50

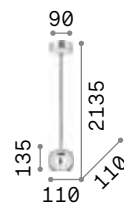

0,520 Kg / 0,0040 m³
GU10 max 1x28W

€ 70

231228 Bianco
116457 Cromo
231259 Nero

3000 K
540 lm

123943 € 3,50



Oil

Montatura in metallo con finitura nero opaco. Diffusore in cemento. Per il modello 110462 12 metri di cavo rivestito in tessuto e fornito con sei ganci di fissaggio e spina italiana che può essere sostituita al rosone.

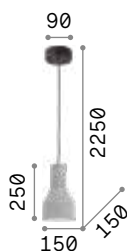

1,780 Kg / 0,0130 m³
E27 max 1x 15W

€ 116

110417 ■ Cemento

3000 K
430 lm

101279 € 2,60

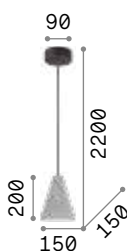

1,180 Kg / 0,0119 m³
E27 max 1x 15W

€ 116

110424 ■ Cemento

3000 K
430 lm

101279 € 2,60

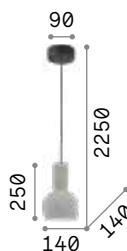

1,810 Kg / 0,0130 m³
E27 max 1x 15W

€ 116

110431 ■ Cemento

3000 K
430 lm

101279 € 2,60

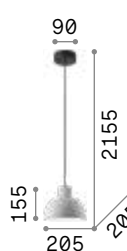

1,650 Kg / 0,0165 m³
E27 max 1x 15W

€ 116

129082 ■ Cemento

3000 K
430 lm

101279 € 2,60



1,760 Kg / 0,0236 m³
E27 max 1x 15W

€ 116

129099 ■ Cemento

3000 K
430 lm

101279 € 2,60

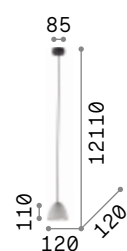

1,490 Kg / 0,0111 m³
GU10 max 1x 15W

€ 138

110462 ■ Cemento

3000 K
410 lm

108292 € 3,00



Tall

Diffusore e dettagli in metallo verniciato bianco o nero opaco. Oltre 5 metri di cavo rivestito in tessuto e fornito con tre ganci di fissaggio.

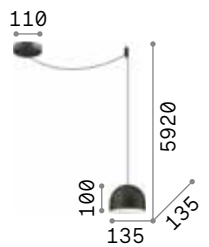

IP20

0,550 Kg / 0,0036 m³
E27 max 1x 42W

€ 135

196770 ■ Bianco
196787 ■ Nero

3000 K
340 lm

101286 € 2,60



196770



196787



A-Line

Rosone in metallo verniciato a polveri. Diffusore in metallo verniciato bianco o nero opaco con interno bianco. Cavo rivestito in tessuto.

Lampadine LED GU10 7W 3000 K
incluse nei modelli: **232690** e **232713**.
Cod. **123943**

LED



232690



232713

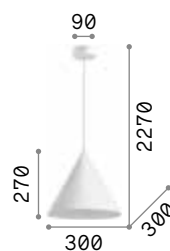

IP20

1,080 Kg / 0,0491 m³
E27 max 1x60W

€ 75

232720 ■ Bianco
232744 ■ Nero

3000 K
900 lm

123899 € 6,00

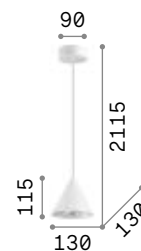

IP20

0,330 Kg / 0,0114 m³
GU10 max 1x28W

€ 53

232690 ■ Bianco
232713 ■ Nero

3000 K
540 lm

123943 € 3,50



Diesis

Rosone e diffusore in metallo verniciato a polveri o placcato. Cavo in pvc nero. Colori: nero, nickel satinato oppure ottone satinato.

LED Sorgente luminosa LED 3000 K, 20.000 h di durata.

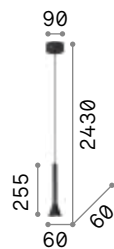

IP20

0,450 Kg / 0,0054 m³
LED 7W / 580 lm

€ 96

285122 ■ Nickel
279770 ■ Nero
279794 ■ Ottone

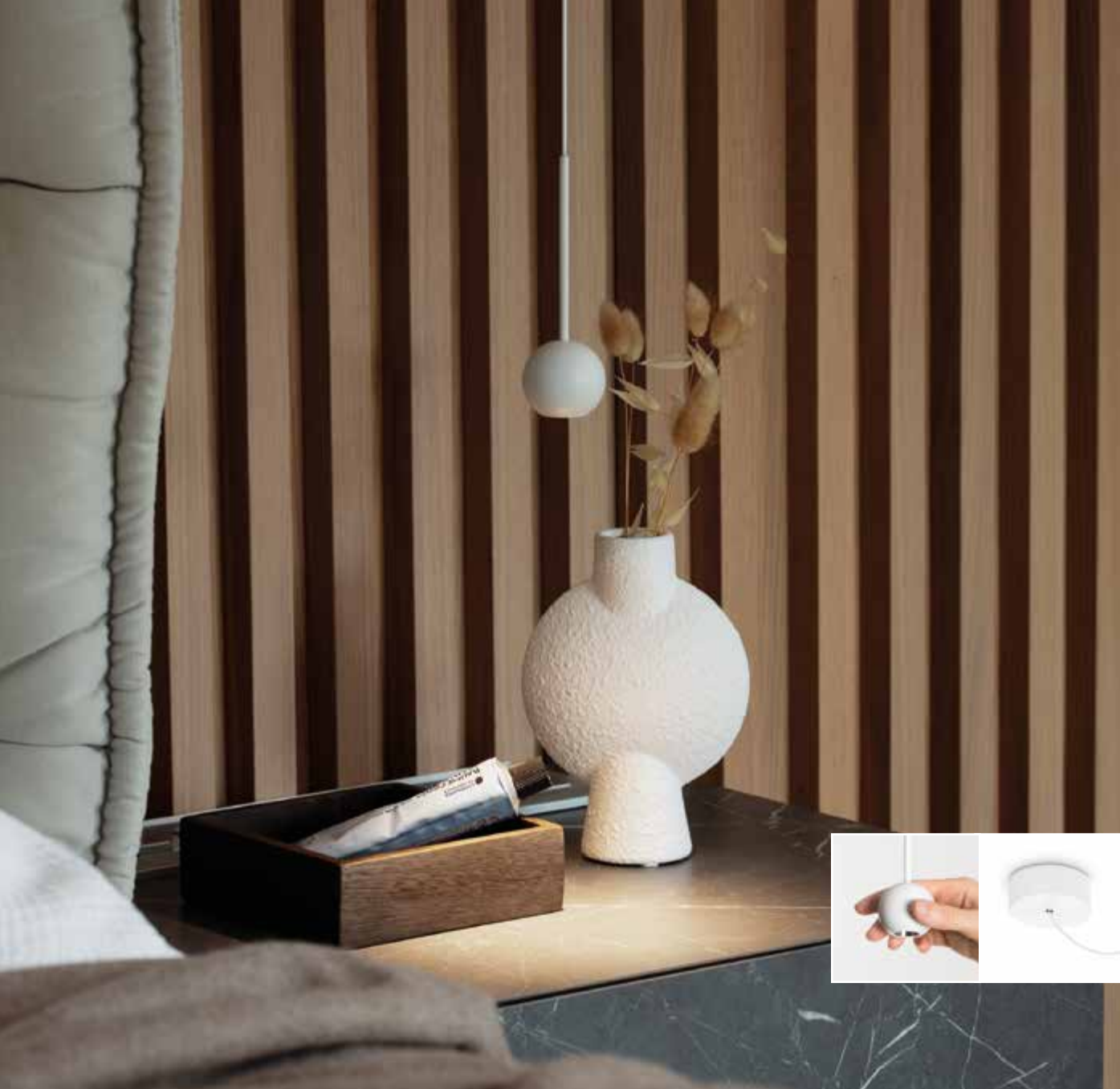

Archimede ^{new}

Rosone in metallo verniciato a polveri con chiusura magnetica senza viti. Cavo in pvc. Diffusore in alluminio verniciato a polveri con ottica in acrilico. Finiture: bianco, nero.

LED Sorgente luminosa LED 3000 K, 50.000 h di durata.

IP20	IP20	IP20
0,150 Kg / 0,0019 m³ LED 3,5W / 230 lm	0,140 Kg / 0,0019 m³ LED 3,5W / 230 lm	0,160 Kg / 0,0019 m³ LED 3,5W / 230 lm
€ 60	€ 70	€ 70
310589 Bianco <i>new</i> 328331 Nero <i>new</i>	310596 Bianco <i>new</i> 328348 Nero <i>new</i>	310602 Bianco <i>new</i> 328355 Nero <i>new</i>



310589



310596



310602



Holly

Rosone e diffusori in metallo con finitura ottone spazzolato o verniciato a polveri con finitura bianca o nera. Cavi rivestiti in tessuto.

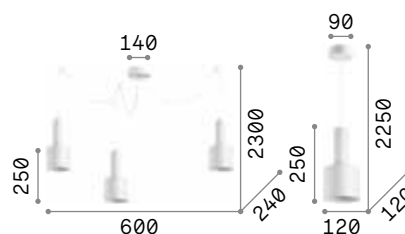

IP20

2,740 Kg / 0,0254 m³
E27 max 3 x 60W

€ 190

231587 Bianco
231594 Nero
231600 Ottone

IP20

0,780 Kg / 0,0064 m³
E27 max 1 x 60W

€ 75

231556 Bianco
231563 Nero
231570 Ottone



231556



231563



231570

3000 K
900 lm

123899 € 6,00

3000 K
900 lm

123899 € 6,00



Triade

Rosone e diffusore in metallo verniciato a polveri con interno bianco. Elemento decorativo a sfera dorato.

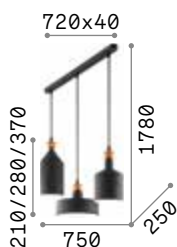

IP20

2,630 Kg / 0,0797 m³
E27 max 3 x 42W

€ 250

194677 ■ Grigio Scuro

3000 K
900 lm

123899 € 6,00

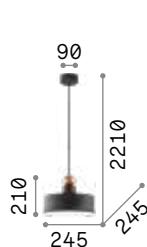

IP20

0,960 Kg / 0,0169 m³
E27 max 1 x 42W

€ 75

221489 ■ Grigio Scuro

3000 K
900 lm

123899 € 6,00

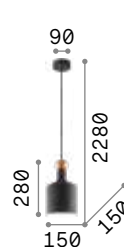

IP20

0,750 Kg / 0,0090 m³
E27 max 1 x 42W

€ 75

221496 ■ Grigio Scuro

3000 K
900 lm

123899 € 6,00

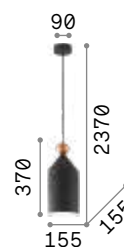

IP20

1,020 Kg / 0,0105 m³
E27 max 1 x 42W

€ 75

194684 ■ Grigio Scuro

3000 K
900 lm

123899 € 6,00





P. 300 P. 536

Mix Up

Rosone e paralumi intercambiabili in metallo verniciato a polveri. Cavo in PVC. Finiture: bianco oppure nero.

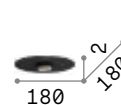
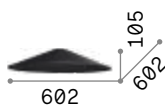
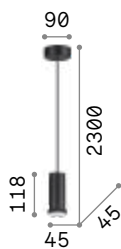

IP20

0,460 Kg / 0,0018 m³
E27 max 1x60W

€ 55

288406 ■ Bianco
288390 ■ Nero

2,000 Kg / 0,0676 m³

€ 85

288437 ■ Bianco
288420 ■ Nero

1,100 Kg / 0,0446 m³

€ 55

307404 ■ Bianco
288475 ■ Nero

0,800 Kg / 0,0147 m³

€ 40

307411 ■ Bianco
288444 ■ Nero

0,500 Kg / 0,0174 m³

€ 35

307428 ■ Bianco
288451 ■ Nero

0,340 Kg / 0,0008 m³

€ 20

307435 ■ Bianco
288482 ■ Nero

3000 K
900 lm
123899 € 6,00



Yurta

Rosone e paralume in metallo verniciato a polveri. Cavi rivestiti in tessuto. Colori: tutto bianco o nero con interno bianco.



285146



281568

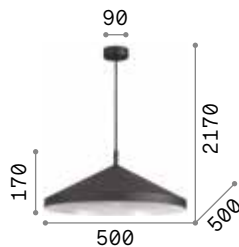

IP20

1,760 Kg / 0,0687 m³
E27 max 1x60W

€ 110

285160 ■ Bianco
281582 ■ Nero

3000 K
900 lm

123899 € 6,00



IP20

1,000 Kg / 0,0277 m³
E27 max 1x60W

€ 80

285153 ■ Bianco
285139 ■ Nero

3000 K
340 lm

101286 € 2,60



IP20

0,740 Kg / 0,0138 m³
E27 max 1x60W

€ 70

285146 ■ Bianco
281568 ■ Nero

3000 K
340 lm

101286 € 2,60

Metro

Montatura e diffusore in metallo.
Interno smaltato in bianco. Cavo
elettrico regolabile in lunghezza.

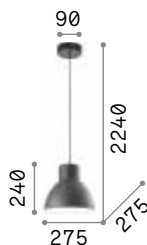

0,970 Kg / 0,0261 m³

E27 max 1x60W

€ 70

139098 ■ Grigio Scuro

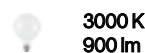

101354 € 8,00



Breeze

Montatura e diffusore in metallo.
Interno smaltato in bianco. Cavo
elettrico regolabile in lunghezza.



3,490 Kg / 0,0707 m³

E27 max 1x60W

€ 195

232041 ■ Grigio Scuro

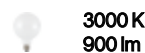

101354 € 8,00

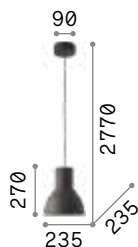

0,790 Kg / 0,0206 m³

E27 max 1x60W

€ 65

137681 ■ Grigio Scuro

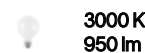

101330 € 7,50





Moby

Montatura e diffusore in metallo con interno bianco. Disponibile nelle finiture bianco, nero o rame.

102047



093697



093659



1,200 Kg / 0,0356 m³
E27 max 1x 42W

€ 127

102047 ■ Bianco
093659 ■ Nero
093697 ■ Rame

3000 K
950 lm

101330 € 7,50



Eris

Montatura in metallo con rosone e diffusore verniciati bianco o nero opaco, dettagli in finitura oro satinato. Cavo elettrico intrecciato con rivestimento in tessuto.



238104



249056

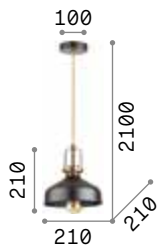

0,630 Kg / 0,0102 m³
E27 max 1x60W

€ 75

238104 ■ Bianco
249056 ■ Nero

3000 K
340 lm

101286 € 2,60

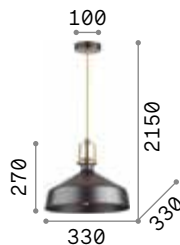

1,080 Kg / 0,0257 m³
E27 max 1x60W

€ 86

238135 ■ Bianco
249063 ■ Nero

3000 K
950 lm

101330 € 7,50



0,740 Kg / 0,0126 m³
E27 max 1x60W

€ 75

238173 ■ Bianco
249070 ■ Nero

3000 K
340 lm

101286 € 2,60

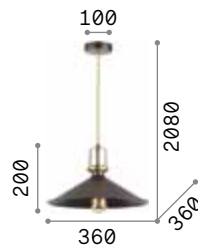

0,960 Kg / 0,0231 m³
E27 max 1x60W

€ 86

238210 ■ Bianco
249087 ■ Nero

3000 K
340 lm

101286 € 2,60

Fisherman

Corpo luce interamente in metallo con finitura in rame o in vernice nera opaca. Diffusore in lastra di vetro serigrafato bianco.

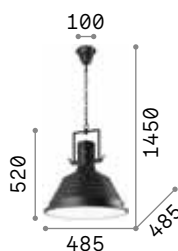

IP20

5,040 Kg / 0,0899 m³

E27 max 1x60W

€ 400

125831 ■ Nero

134871 ■ Rame

3000 K
1120 lm

101323 € 7,00



125831



134871



Cantina

Montatura, diffusore e copriportalampada in metallo disponibile con finitura brunito o rame. Cavo elettrico rivestito in tessuto e intrecciato.

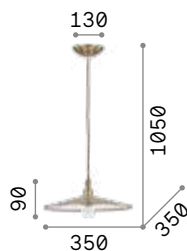

IP20

0,810 Kg / 0,0189 m³

E27 max 1x60W

€ 95

112732 ■ Rame

112701 ■ Brunito

3000 K
910 lm

119571 € 6,00



112732



112701

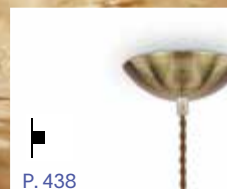

P. 438



Flam

Montatura in metallo cromato.
 Diffusore in vetro pirex
 trasparente, smerigliato nella zona
 centrale.

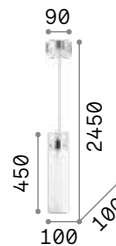

IP20

1,330 Kg / 0,0164 m³
 E27 max 1x 60W

€ 68

027364 Bianco

3000 K
 910 lm
 119571 € 6,00

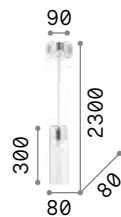

IP20

0,810 Kg / 0,0115 m³
 E27 max 1x 60W

€ 62

027357 Bianco

3000 K
 910 lm
 119571 € 6,00



Gocce

Montatura in metallo cromato.
Diffusore in tubolare di vetro pirex.
Elementi decorativi con ottagoni
e gocce in cristallo molato. Cavi
elettrici regolabili in lunghezza.

LED

Lampadine LED GU10 7W 3000 K
incluse. Cod. **123943**



1,140 Kg / 0,0123 m³
GU10 max 1x28W

€ 130

089669 ■ **Cromo**

3000 K
540 lm

123943

€ 3,50



Cono

Montatura e copri porta lampade in metallo cromato. Diffusore in vetro soffiato a mano. Disponibile in cromo con vetro tutto trasparente.

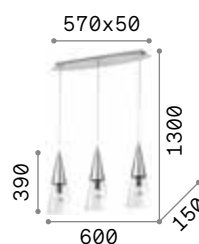

IP20

4,110 Kg / 0,0763 m³
E14 max 3 x 40W

€ 300

112367 Cromo

3000 K
300 lm
101255 € 3,70

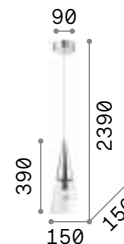

IP20

1,420 Kg / 0,0243 m³
E14 max 1 x 40W

€ 120

017440 Cromo

3000 K
300 lm
101255 € 3,70



Kuky

Montatura in metallo cromato.
Disponibile con vetro pirex
smerigliato a sabbia nella zona
centrale.

IP20	IP20	IP20
4,580 Kg / 0,0766 m³ E27 max 4 x 60W	2,510 Kg / 0,0464 m³ E27 max 3 x 60W	0,980 Kg / 0,0165 m³ E27 max 1 x 60W
€ 240	€ 170	€ 58
023038 Trasparen.	033952 Trasparen.	023021 Trasparen.
3000 K 910 lm 119571 € 6,00	3000 K 910 lm 119571 € 6,00	3000 K 910 lm 119571 € 6,00



Milk

Base ellittica in metallo smaltato bianco. Diffusore in vetro bianco soffiato e acidato. Cavi elettrici regolabili in lunghezza.



IP20

4,220 Kg / 0,1024 m³
E27 max 3 x 60W

€ 265

030326 Bianco

3000 K
900 lm

123899 € 6,00

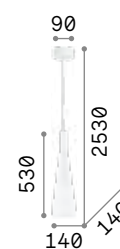

IP20

1,270 Kg / 0,0354 m³
E27 max 1 x 60W

€ 105

026787 Bianco

3000 K
900 lm

123899 € 6,00



Cocktail

Diffusore in vetro soffiato incamiciato e acidato. Bianco all'interno e colorato all'esterno. Sospensioni con cavi a lunghezza regolabile.

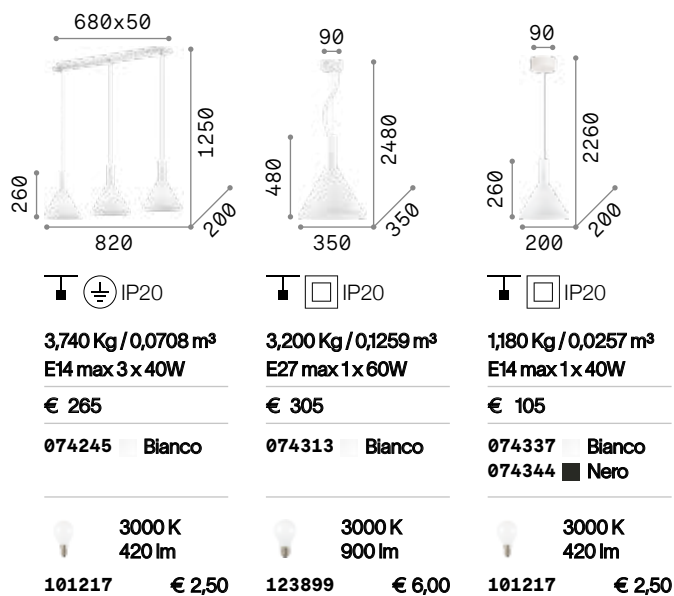



Tristan

Rosone e corpo luce in metallo verniciato a polveri. Paralume in acrilico trasparente rigato. Diffusore in policarbonato satinato. Cavo in pvc trasparente. Disponibile nelle finiture bianco, nero o oro metallizzato.



256429

256436

256443

LED

Sorgente luminosa LED 3000 K, 20.000 h di durata.

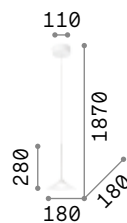

IP20

0,430 Kg / 0,0099 m³
LED 5W / 540 lm

€ 85

256429 ■ Bianco

256436 ■ Nero

256443 ■ Oro

Manhattan

Rosone e diffusore in metallo rifinito con vernice opaca bianca o nera e con dettaglio in legno naturale. Cavo in tessuto.

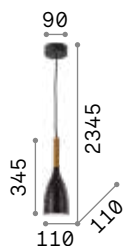

0,560 Kg / 0,0061 m³

E14 max 1x 40W

€ 75

110745 Bianco

110752 Nero

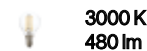

101200 € 2,50



Flut

Diffusore in vetro soffiato incamiciato e acidato, bianco all'interno e colorato all'esterno. Cavo a lunghezza regolabile.

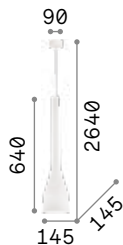

1,570 Kg / 0,0422 m³

E27 max 1x 60W

€ 140

035666 Bianco

035680 Nero

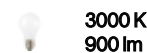

123899 € 6,00

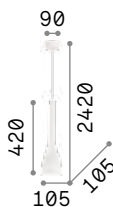

0,930 Kg / 0,0179 m³

E14 max 1x 40W

€ 75

035697 Bianco

035710 Nero

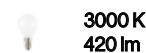

101217 € 2,50





Origami

Montatura in metallo verniciato opaco. Diffusori in vetro bianco soffiato e acidato con effetto piegature in rilievo.

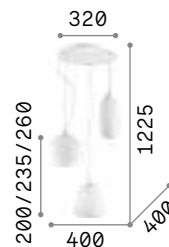

IP20

3,740 Kg / 0,0642 m³
E27 max 3 x 60W

€ 280

198095 Bianco

3000 K
900 lm

123899 € 6,00



Umile

Rosone ed elementi decorativi in metallo con finitura oro satinato. Diffusori in vetro soffiato bianco acidato. Led integrati.

LED Sorgente luminosa LED 3000 K, 20.000 h di durata.

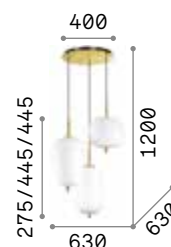

IP20

8,600 Kg / 0,2150 m³
LED 60,2W / 5300 lm

€ 415

224541 Bianco

Blossom

Montatura e rosone in metallo cromato. Diffusore in vetro soffiato trasparente con finitura ambra o fumè. Cavo elettrico in pvc trasparente.

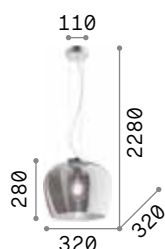

1,890 Kg / 0,0705 m³

E27 max 1x 60W

€ 175

241517 ■ Fumè

241524 ■ Ambra

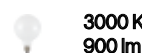

101354 € 8,00



241517



241524



Lord

Rosone e montatura in metallo verniciato a polveri con finitura nera. Cavo in pvc nero. Diffusore in vetro soffiato con decori in rilievo. Disponibile con vetro ambra, trasparente o fumè.

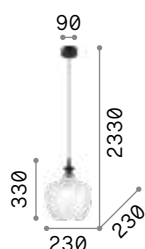

1,430 Kg / 0,0389 m³

E27 max 1x 60W

€ 105

263632 ■ Trasparen.

263649 ■ Fumè

263656 ■ Ambra

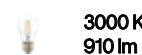

119571 € 6,00





Fade

Rosone e montatura in metallo.
Paralume in vetro soffiato trasparente con sfumatura galvanica. Diffusore interno in vetro soffiato bianco acidato. Cavo in pvc nero. Colori paralumi: trasparente con sfumatura ambra, cromo o rame.

LED Lampadine LED G9 4W 3000 K incluse.
Cod. **209043**

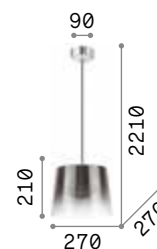

1,900 Kg / 0,0370 m³
G9 max 1x 15W

€ 200

271293 Cromo
271316 Ambra
271309 Rame

3000 K
510 lm
305486 € 6,00



Audi-20

Elemento centrale portalampada in metallo cromato. Diffusore in vetro soffiato trasparente. Cavo in acciaio a lunghezza regolabile con dispositivo ferma cavo automatico.

LED Lampadine LED E27 8W Globo D125 3000 K include. Cod. **101347**

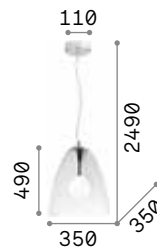

IP20 

4,370 Kg / 0,1017 m³
E27 max 1x 60W

€ 298

016931  Trasparen.

 3000 K
900 lm

101354 € 8,00



Tolomeo

Diffusore in vetro soffiato, incamiciato e decorato a mano. Cavi in acciaio a lunghezza regolabile con dispositivi ferma cavo automatici.



IP20

3,390 Kg / 0,0871 m³
E27 max 1x60W

€ 280

001814 ■ Bianco
001821 ■ Grigio

3000 K
900 lm

101354 € 8,00



Karma

Montatura in metallo cromato.
 Diffusore in vetro soffiato bianco
 incamiciato e acidato. Cavi in
 acciaio a lunghezza regolabile da
 dispositivi ferma cavo automatici.

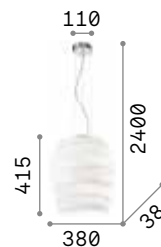

IP20

4,310 Kg / 0,1185 m³
 E27 max 1x60W

€ 200

132365 Bianco

3000 K
 900 lm

101354 € 8,00

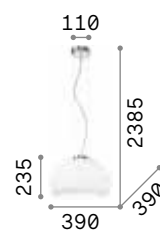

IP20

3,700 Kg / 0,0693 m³
 E27 max 1x60W

€ 200

132389 Bianco

3000 K
 900 lm

101354 € 8,00



Folk

Rosone e diffusore in metallo rifinito in vernice opaca con finitura coffee. Parabola interna ondulata e smaltata. Cavo in tessuto.

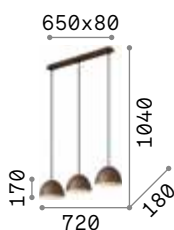

IP20

2,190 Kg / 0,0255 m³
E27 max 3 x 60W

€ 245

174235 ■ Coffee

3000 K
340 lm
101286 € 2,60

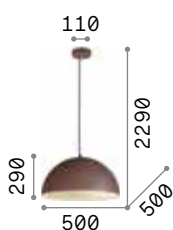

IP20

3,070 Kg / 0,0843 m³
E27 max 1 x 60W

€ 290

174228 ■ Coffee

3000 K
900 lm
101354 € 8,00

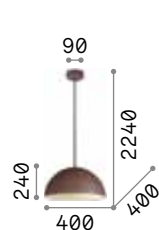

IP20

1,980 Kg / 0,0420 m³
E27 max 1 x 60W

€ 160

174211 ■ Coffee

3000 K
950 lm
101330 € 7,50

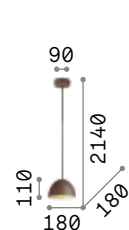

IP20

0,530 Kg / 0,0072 m³
E27 max 1 x 60W

€ 85

174204 ■ Coffee

3000 K
900 lm
123899 € 6,00

Aria

Diffusore in vetro bianco soffiato e acidato. Cavi in acciaio a lunghezza regolabile con dispositivi ferma cavo automatici.

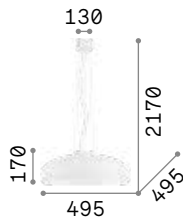

4,080 Kg / 0,0847 m³
E27 max 1x 60W

€ 285

059679 Bianco

3000 K
950 lm

101330 € 7,50



Plissè

Montatura in metallo placcato. Diffusore in vetro soffiato bianco acidato, con decoro in rilievo. Cavo elettrico in pvc trasparente. Colori: cromo oppure ottone satinato.

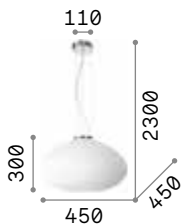

3,300 Kg / 0,1208 m³
E27 max 1x 60W

€ 250

264523 Cromo
285191 Ottone

3000 K
900 lm

123899 € 6,00

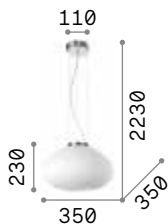

2,060 Kg / 0,0705 m³
E27 max 1x 60W

€ 185

285184 Cromo
264547 Ottone

3000 K
900 lm

123899 € 6,00



Lana

Diffusore in vetro trasparente con decorazioni serigrafate all'interno e sabbiate all'esterno. Ganci ferma vetro in metallo cromato.

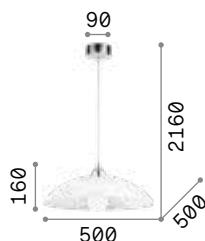

IP20

2,720 Kg / 0,0533 m³

E27 max 1x60W

€ 116

068169 Bianco

3000 K
950 lm

101330

€ 7,50

P. 306



Lena

Montatura in metallo cromato.
Diffusore con doppio vetro:
smerigliato e colorato quello
esterno, bianco quello interno.
Sospensioni con cavi in acciaio a
lunghezza regolabile da dispositivi
automatici.

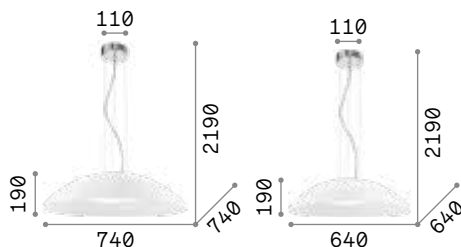

IP20

8,310 Kg / 0,1785 m³

E27 max 3x60W

€ 390

052786 Bianco

3000 K
340 lm

101286

€ 2,60

IP20

6,600 Kg / 0,1304 m³

E27 max 3x60W

€ 335

035727 Bianco

3000 K
340 lm

101286

€ 2,60





Smarties

Montatura in metallo verniciato bianco. Diffusore in vetro bianco soffiato. Cavi in acciaio a lunghezza regolabile con dispositivi ferma cavo automatici.

IP20	IP20	IP20
5,280 Kg / 0,1479 m ³ E27 max 5 x 60W	3,740 Kg / 0,1009 m ³ E27 max 3 x 60W	2,930 Kg / 0,0645 m ³ E27 max 3 x 60W
€ 290	€ 200	€ 175
031996 Bianco	032009 Bianco	032016 Bianco
3000 K 340 lm	3000 K 340 lm	3000 K 340 lm
101286 € 2,60	101286 € 2,60	101286 € 2,60



P. 287



P. 397



P. 485



Glory

Rosone rifinito in nickel satinato. Diffusore in vetro bianco soffiato e acidato. Sospensioni con cavi in acciaio regolabili in lunghezza con dispositivi automatici.

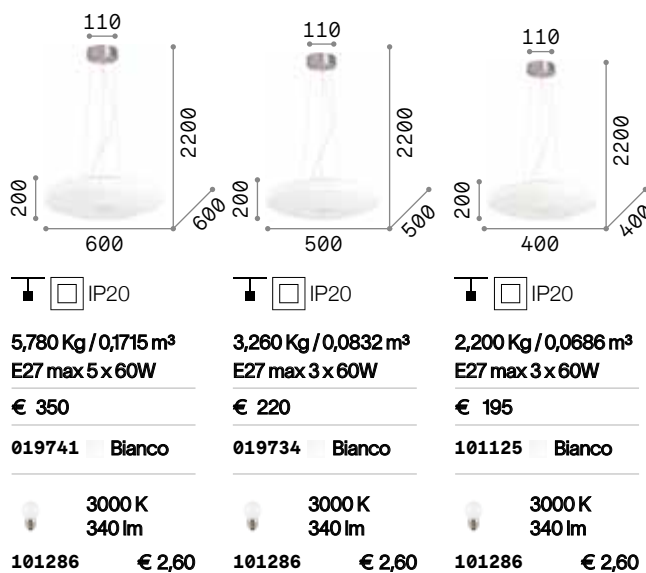

Ulisse

Montatura in metallo verniciato bianco opaco. Diffusore in vetro bianco soffiato e acidato. Sospensioni con cavi in acciaio a lunghezza regolabile da dispositivi automatici.

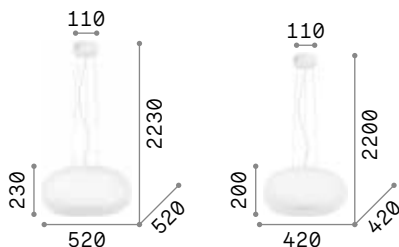

IP20

IP20

5,010 Kg / 0,1177 m³
E27 max 3 x 60W

3,110 Kg / 0,0720 m³
E27 max 3 x 60W

€ 295

€ 225

098616 Bianco

095226 Bianco

3000 K
910 lm

3000 K
910 lm

119571 € 6,00

119571 € 6,00



Arizona

Montatura in metallo rifinito in ottone satinato. Diffusore in vetro bianco soffiato, acidato e con rigature decorative in rilievo.

LED Lampadine LED GX53 9W 3000 K incluse. Cod. **123936**

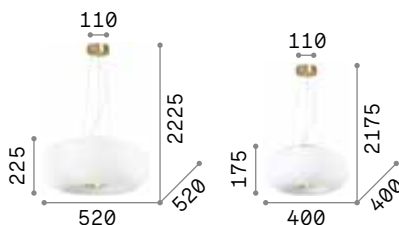

IP20

IP20

6,190 Kg / 0,1288 m³
GX53 max 5 x 15W

3,260 Kg / 0,0740 m³
GX53 max 3 x 15W

€ 520

€ 395

214481 Bianco

214474 Bianco

3000 K
910 lm

3000 K
910 lm

123936 € 5,50

123936 € 5,50



P. 288





Ovalino

Diffusore composto da elementi circolari in lastra di vetro curvata e acidata. Cavi in acciaio regolabili in lunghezza da dispositivi automatici.

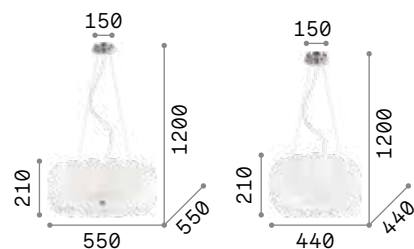

IP20

6,700 Kg / 0,1448 m³
E27 max 8 x 60W

€ 325

090481 Bianco

3000 K
900 lm

123899 € 6,00

IP20

4,810 Kg / 0,1184 m³
E27 max 5 x 60W

€ 255

074139 Bianco

3000 K
900 lm

123899 € 6,00



P. 294



P. 394



Candy

Montatura in metallo bianco.
 Diffusore in vetro bianco soffiato e acidato. Cavi in acciaio a lunghezza regolabile con dispositivi ferma cavo automatici.

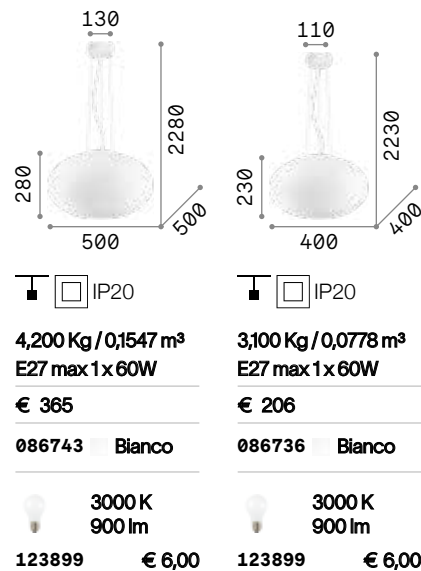



Cotton new

Montatura e rosone in metallo rifinito con vernice a polveri di colore bianco con chiusura magnetica senza viti. Cavo in pvc trasparente. Diffusore in vetro soffiato bianco acidato.

LED

Lampadine LED G9 4W 3000 K incluse nel modello **297781**. Cod. **209043**

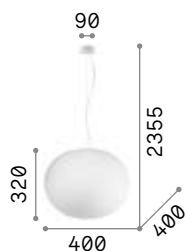

IP20

2,600 Kg / 0,0810 m³
E27 max 1x42W

€ 200

327884 Bianco new 297767 Bianco new 297781 Bianco new

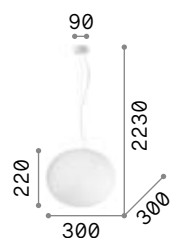

IP20

1,640 Kg / 0,0207 m³
E27 max 1x42W

€ 135

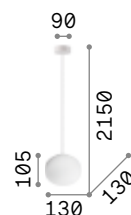

IP20 INCLUSA

0,540 Kg / 0,0204 m³
G9 max 1x4W

€ 70



P. 291



P. 485

3000 K
900 lm
123899 € 6,00

3000 K
900 lm
123899 € 6,00

3000 K
510 lm
305486 € 6,00



Clown

Montatura in metallo con diffusori in vetro soffiato e modellato a mano. Disponibile con montatura in cromo e vetri multicolor o con montatura e vetri bianchi.

LED Lampadine LED G9 4W 3000 K incluse. Cod. 209043



100944



100883

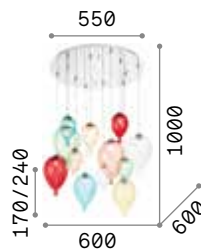

IP20

6,000 Kg / 0,1860 m³
G9 max 12 x 28W

€ 750

100951 Color

3000 K
510 lm

305486 € 6,00

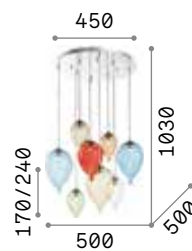

IP20

5,700 Kg / 0,1442 m³
G9 max 8 x 28W

€ 545

100944 Color
100883 Bianco

3000 K
510 lm

305486 € 6,00

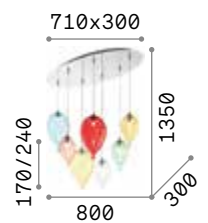

IP20

5,000 Kg / 0,1283 m³
G9 max 7 x 28W

€ 493

100937 Color

3000 K
510 lm

305486 € 6,00



Mapa Plus

Montatura in metallo bianco.
Diffusore a sfera in vetro bianco
soffiato e acidato. Cavi in acciaio a
lunghezza regolabile.

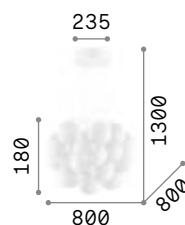

IP20

10,800 Kg / 0,1976 m³
E14 max 22 x 40W

€ 670

140230 Bianco

3000 K
420 lm

101217 € 2,50

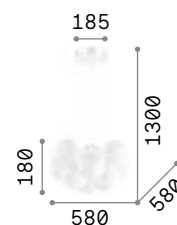

IP20

5,520 Kg / 0,1205 m³
E14 max 11 x 40W

€ 400

131924 Bianco

3000 K
420 lm

101217 € 2,50



Luce Max

Montatura in cromo. Diffusore in vetro soffiato con decorazione interna in filo d'alluminio. Sospensioni con cavo in acciaio a lunghezza regolabile da dispositivo ferma cavo automatico.

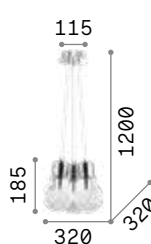

IP20

2,150 Kg / 0,0458 m³
E27 max 3 x 60W

€ 200

081762 Trasparen.

3000 K
910 lm

119571 € 6,00

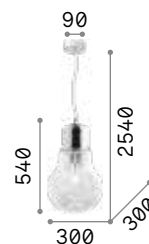

IP20

2,460 Kg / 0,0732 m³
E27 max 1 x 60W

€ 120

033662 Trasparen.

3000 K
910 lm

119571 € 6,00

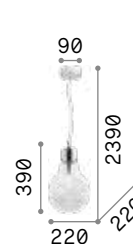

IP20

1,500 Kg / 0,0334 m³
E27 max 1 x 60W

€ 84

033679 Trasparen.

3000 K
910 lm

119571 € 6,00

Mapa Sat

Montatura in metallo con finitura nickel o ottone. Diffusore in vetro soffiato trasparente con decoro interno in filo d'alluminio.

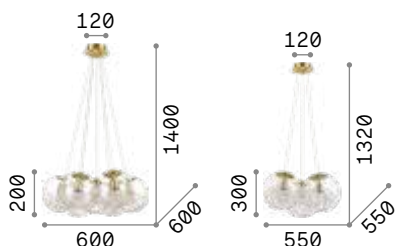

IP20

6,550 Kg / 0,1862 m³
E27 max 7x60W

€ 520

176062 Nickel
176000 Ottone

3000 K
910 lm

119571 € 6,00



IP20

2,700 Kg / 0,1210 m³
E27 max 3x60W

€ 295

176031 Nickel
175973 Ottone

3000 K
910 lm

119571 € 6,00

176031

175973



Mapa Max

Montatura in cromo. Diffusore in vetro soffiato con decorazione interna in filo d'alluminio. Sospensioni con cavo in acciaio a lunghezza regolabile da dispositivo ferma cavo automatico.

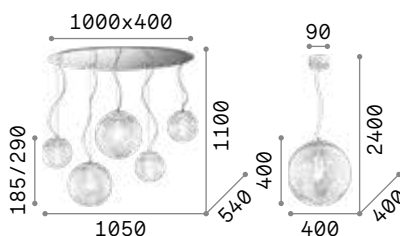

IP20

8,700 Kg / 0,2456 m³
E27 max 5x60W

€ 540

091112 Cromo

3000 K
910 lm

119571 € 6,00

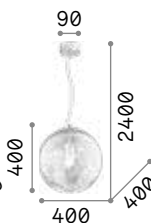

IP20

3,450 Kg / 0,1370 m³
E27 max 1x60W

€ 166

045122 Cromo

3000 K
910 lm

119571 € 6,00

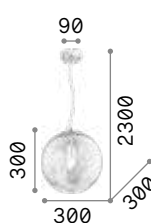

IP20

1,370 Kg / 0,0527 m³
E27 max 1x60W

€ 118

045115 Cromo

3000 K
910 lm

119571 € 6,00





Mapa Fade

Rosone e montatura in metallo cromato. Diffusore a sfera in vetro soffiato trasparente rifinito con cromatura sfumata verso il basso. Cavo in pvc trasparente. Colore: cromo.

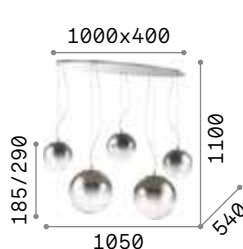

IP20

8,700 Kg / 0,2470 m³
E27 max 5x60W

€ 640

140759 CromoStum.

3000 K
910 lm

119571 € 6,00

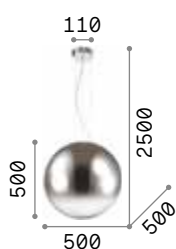

IP20

5,390 Kg / 0,2254 m³
E27 max 1x60W

€ 480

161327 CromoStum.

3000 K
910 lm

119571 € 6,00

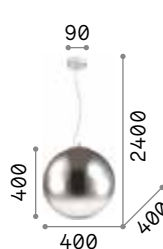

IP20

3,620 Kg / 0,1215 m³
E27 max 1x60W

€ 270

161334 CromoStum.

3000 K
910 lm

119571 € 6,00

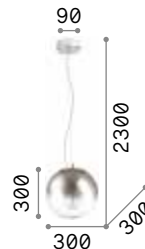

IP20

1,920 Kg / 0,0630 m³
E27 max 1x60W

€ 165

140728 CromoStum.

3000 K
910 lm

119571 € 6,00

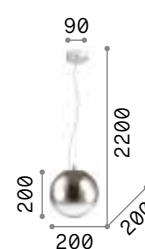

IP20

1,130 Kg / 0,0272 m³
E27 max 1x60W

€ 95

140711 CromoStum.

3000 K
910 lm

119571 € 6,00



Mapa Bianco ^{new}

Montatura in metallo bianco.
Diffusore a sfera in vetro bianco
soffiato e acidato. Cavi in acciaio a
lunghezza regolabile.

LED Lampadine LED G9 4W 3000 K incluse
nel modello **310800**. Cod. **209043**

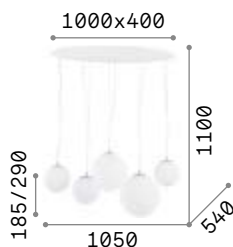

IP20

8,700 Kg / 0,2470 m³
E27 max 5x60W

€ 530

043562 Bianco

3000 K
910 lm

119571 € 6,00

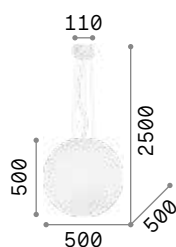

IP20

5,390 Kg / 0,2254 m³
E27 max 1x60W

€ 303

032122 Bianco

3000 K
910 lm

119571 € 6,00



IP20

3,620 Kg / 0,1215 m³
E27 max 1x60W

€ 145

032139 Bianco

3000 K
910 lm

119571 € 6,00

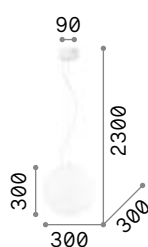

IP20

1,920 Kg / 0,0630 m³
E27 max 1x60W

€ 78

009087 Bianco

3000 K
910 lm

119571 € 6,00

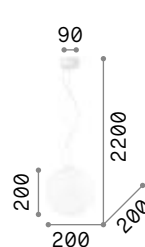

IP20

1,130 Kg / 0,0272 m³
E27 max 1x60W

€ 52

009148 Bianco

3000 K
910 lm

119571 € 6,00

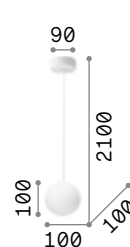

IP20

0,041 Kg / 0,0027 m³
G9 max 1x15W

€ 50

310800 Bianco ^{new}

3000 K
510 lm

305486 € 6,00



Carta

Montatura in metallo verniciato bianco opaco. Diffusore in policarbonato con rivestimento ad effetto carta. Cavo rivestito in tessuto.

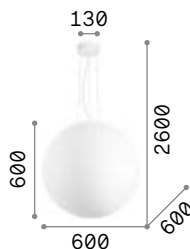

IP20

2,750 Kg / 0,2746 m³
E27 max 1x60W

€ 475

272139 Bianco

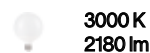

151786 € 7,50

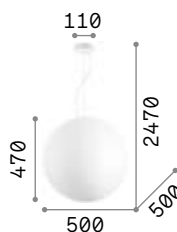

IP20

1,780 Kg / 0,1662 m³
E27 max 1x25W

€ 360

226040 Bianco

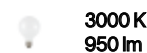

101330 € 7,50

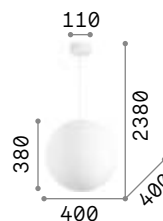

IP20

1,460 Kg / 0,0911 m³
E27 max 1x25W

€ 225

226033 Bianco

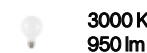

101330 € 7,50

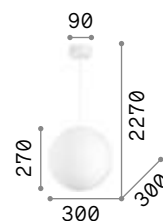

IP20

0,860 Kg / 0,0428 m³
E27 max 1x25W

€ 110

226026 Bianco

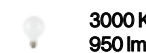

101330 € 7,50

P. 293 P. 397 P. 484 P. 545



Boa

Montatura in metallo verniciato opaco bianco o nero. Cavo in tessuto da 12 metri con 6 supporti. Diffusore in vetro soffiato bianco acidato.



160863

160856

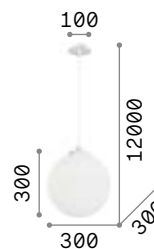

IP20

2,900 Kg / 0,0726 m³
E27 max 1x60W

€ 155

160863 ■ Bianco
160856 ■ Nero

3000 K
900 lm

123899 € 6,00

Rubber new

Rosone in metallo verniciato opaco.
Cavo in pvc trasparente. Elemento reggi vetro in silicone trasparente opaco. Diffusore in vetro soffiato.
Finiture rosone: bianco, nero.
Finiture vetro: ambra, fumé, satinato, trasparente.

LED Sorgente luminosa LED 3000 K, 50.000 h di durata.



327365



327372

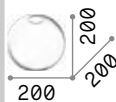

0,300 Kg / 0,0114 m³

€ 70

289786 Trasparen. new
289939 Bianco new
289908 Fumè new
289915 Ambra new

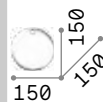

0,250 Kg / 0,0054 m³

€ 45

289861 Trasparen. new
327433 Bianco new
327457 Fumè new
327419 Ambra new

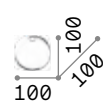

0,200 Kg / 0,0020 m³

€ 30

289878 Trasparen. new
327426 Bianco new
327440 Fumè new
327402 Ambra new



Nemo

Diffusore in vetro soffiato.
Disponibile in versione fumé,
trasparente, rame o cromo
sfumato.



052809 149592 094236 250335 111902

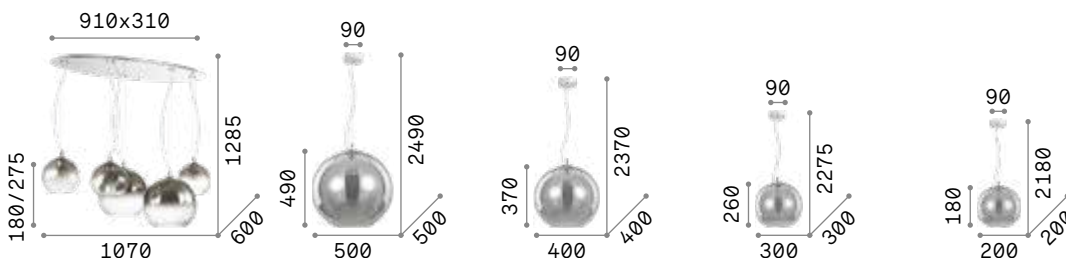

IP20
 IP20
 IP20
 IP20
 IP20

8,700 Kg / 0,2424 m³
 4,000 Kg / 0,2220 m³
 2,700 Kg / 0,1227 m³
 2,050 Kg / 0,0664 m³
 1,300 Kg / 0,0241 m³
E27 max 5x60W
E27 max 1x60W
E27 max 1x60W
E27 max 1x60W
E27 max 1x60W

€ 650
€ 450
€ 250
€ 165
€ 80

138305 CromoStum.
 094137 Fumè
 052816 Trasparen.
 149592 CromoStum.
 149585 CromoStum.
 250359 CromoStum.
 250311 Fumè
 094229 Fumè
 094236 Fumè
 250304 Cromo
 250342 Cromo
 250335 Cromo
 111919 Rame
 052809 Trasparen.
 111902 Rame
 250328 Rame

3000 K
910 lm
 3000 K
1020 lm
 3000 K
1020 lm
 3000 K
1120 lm
 3000 K
1120 lm
119571 € 6,00
101347 € 8,00
101347 € 8,00
101323 € 7,00
101323 € 7,00



Dna

Rosone e montatura in metallo dorato. Diffusori in vetro incamiciato bianco, soffiato e acidato. Cavi d'acciaio regolabili.



Lampadine LED G9 4W 3000 K incluse.
Cod. **209043**

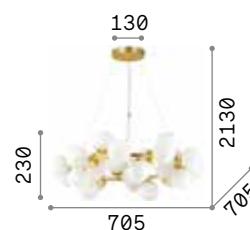

4,930 Kg / 0,2034 m³
G9 max 25 x 15W

€ 1100

208398 **Bianco**

3000 K
510 lm

305486 **€ 6,00**



Nodi

Montatura in metallo cromato oppure in ottone satinato. Diffusori in vetro bianco soffiato, acidato o trasparente e cromato.



082073



241012



200491

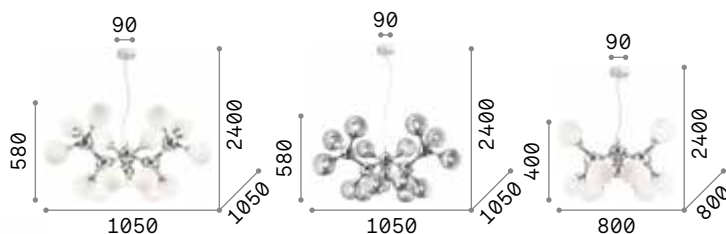

8,000 Kg / 0,3063 m³
E14 max 15 x 28W

€ 630

082073 ■ Bianco
241012 ■ Ottone

3000 K
480 lm

101200 € 2,50



8,000 Kg / 0,4651 m³
E14 max 15 x 28W

€ 800

200491 ■ Cromo

3000 K
480 lm

101200 € 2,50



5,300 Kg / 0,1480 m³
E14 max 9 x 28W

€ 430

082059 ■ Bianco
241036 ■ Ottone

3000 K
480 lm

101200 € 2,50



P. 332



Dream Big

Rosone in metallo verniciato bianco opaco. Cavo in tessuto. Diffusore in vetro soffiato bianco acidato. Cesto in corda.

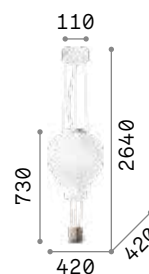

IP20

3,830 Kg / 0,1676 m³
E27 max 1x 42W

€ 265

261195 Bianco

3000 K
900 lm

123899 € 6,00

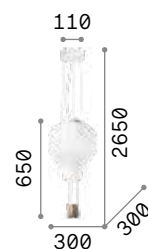

IP20

2,420 Kg / 0,1013 m³
E27 max 1x 42W

€ 155

179858 Bianco

3000 K
900 lm

123899 € 6,00

Avion

Corpo luce e rosone in legno dipinto con vernice opaca. Dettagli in metallo cromato. Diffusori in vetro soffiato bianco acidato.

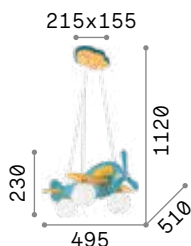

IP20

2,440 Kg / 0,0618 m³
E14 max 3x28W

€ 190

136325 ■ Azzurro
136318 ■ Rosso

3000 K
420 lm

101217 € 2,50



Multiflex

Montatura in metallo rifinito con vernice opaca. Bracci flessibili rivestiti di gomma. Cavo in acciaio regolabile in lunghezza da dispositivo automatico.

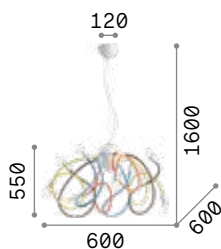

IP20

4,440 Kg / 0,0656 m³
E14 max 8x40W

€ 400

141893 ■ Bianco
141909 ■ Color

3000 K
420 lm

101217 € 2,50



141893



141909



P. 339

175



Lumiere **new**

Montatura e rosone in metallo verniciato opaco con chiusura magnetica. Cavo in pvc trasparente. Diffusore tubolare centrale bianco. Elementi decorativi in vetro soffiato bianco lucido e trasparente grigio.

LED Sorgente luminosa LED 3000 K, 25.000 h di durata.



IP20	IP20	IP20
3,380 Kg / 0,0705 m³ LED 27W / 3050 lm	3,900 Kg / 0,0664 m³ LED 34W / 3350 lm	3,330 Kg / 0,0044 m³ LED 39W / 4550 lm
€ 270	€ 300	€ 300
314143 Bianco new	314167 Bianco new	314174 Bianco new



P. 346



P. 482



P. 520



Empire new

Montatura e rosone in metallo placcato color oro con chiusura magnetica senza viti. Cavo in pvc nero. Diffusore in vetro trasparente con sfumatura grigia.

LED

Lampadine LED G9 4W 3000 K incluse.
Cod. **209043**

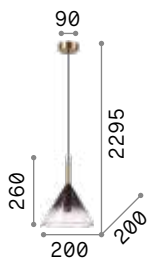
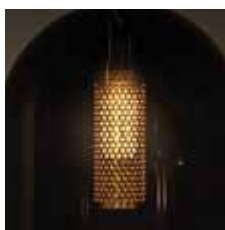

0,600 Kg / 0,0194 m³
G9 max 1x28W

€ 100

309798 **Cromo S. new**

305486 **3000 K**
510 lm € 6,00

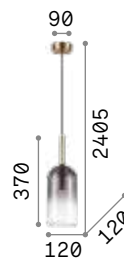

0,600 Kg / 0,0168 m³
G9 max 1x28W

€ 100

309804 **Cromo S. new**

305486 **3000 K**
510 lm € 6,00

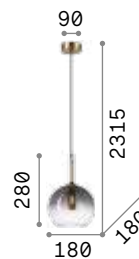

0,600 Kg / 0,0206 m³
G9 max 1x28W

€ 100

309811 **Cromo S. new**

305486 **3000 K**
510 lm € 6,00



Lido

Montatura in metallo cromato. Cavo in tessuto. Diffusori in vetro soffiato trasparente fumè.

LED Lampadine LED G9 4W 3000 K incluse.
Cod. **209043**

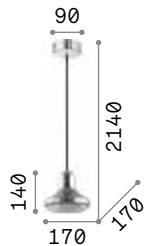

0,790 Kg / 0,0180 m³
G9 max 1x15W

€ 78

168326 ■ Fumè

3000 K
510 lm

305486 € 6,00

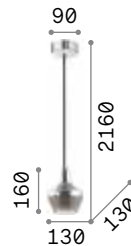

0,790 Kg / 0,0156 m³
G9 max 1x15W

€ 78

168357 ■ Fumè

3000 K
510 lm

305486 € 6,00

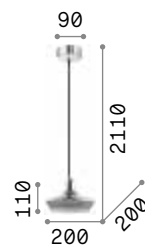

0,660 Kg / 0,0243 m³
G9 max 1x15W

€ 88

168364 ■ Fumè

3000 K
510 lm

305486 € 6,00



Soft

Montatura in metallo con finiture bianco e cromo. Diffusori in vetro soffiato bianco o fumè.



087818



111841

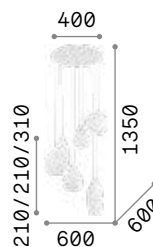

IP20

6,400 Kg / 0,1138 m³
E14 max 6 x 40W

€ 390

087818 ■ Bianco
111841 ■ Fumè

3000 K
420 lm

101217 € 2,50

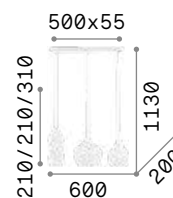

IP20

3,000 Kg / 0,0657 m³
E14 max 3 x 40W

€ 220

111858 ■ Bianco
111865 ■ Fumè

3000 K
420 lm

101217 € 2,50



Coco

Montatura in metallo verniciato a polveri con finitura nera. Diffusore in acrilico trasparente con bordo laterale satinato. Vetro soffiato trasparente con finitura fumè. Cavo in pvc.

LED Sorgente luminosa LED 3000 K, 20.000 h di durata.

IP20	IP20	IP20
1,200 Kg / 0,0128 m³ LED 7W / 580 lm	1,140 Kg / 0,0132 m³ LED 7W / 580 lm	1,080 Kg / 0,0152 m³ LED 7W / 580 lm
€ 152	€ 152	€ 152
275567 ■ Fumè	275581 ■ Fumè	275543 ■ Fumè



Decor

Rosone e montatura in metallo con finitura ottone satinato. Diffusore trasparente in materiale acrilico decorato con effetto cristallo smerigliato. Cavo in pvc nero.

LED Sorgente luminosa LED 3000 K, 20.000 h di durata.



IP20	IP20	IP20	IP20
0,700 Kg / 0,0078 m ³ LED 7W / 850 lm	0,900 Kg / 0,0101 m ³ LED 10W / 1300 lm	1,100 Kg / 0,0123 m ³ LED 14W / 1750 lm	1,400 Kg / 0,0173 m ³ LED 20W / 2600 lm
€ 110	€ 125	€ 145	€ 180
292076 Trasparen.	292083 Trasparen.	292090 Trasparen.	292113 Trasparen.



Mint

Montatura in metallo con finitura ottone satinato e rosone nero opaco. Cavo rivestito in tessuto. Diffusore in vetro soffiato con rigatura in rilievo. Disponibile nelle finiture fumè o verde.



237510



237497

IP20	IP20	IP20
1,350 Kg / 0,0147 m³ E27 max 1x 60W	1,560 Kg / 0,0532 m³ E27 max 1x 60W	1,80 Kg / 0,0269 m³ E27 max 1x 60W
€ 105	€ 127	€ 138
237442 Fumè 248554 Verde	237398 Fumè 237428 Verde	237510 Fumè 237497 Verde
3000 K 910 lm	3000 K 910 lm	3000 K 910 lm
119571 € 6,00	119571 € 6,00	119571 € 6,00



Bergen

Rosone in metallo verniciato a polveri di colore nero. Montatura in legno naturale. Diffusore in vetro soffiato trasparente con motivo decorativo in rilievo e finitura fumè. Cavo rivestito in tessuto.

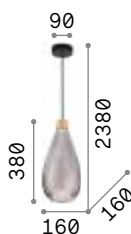
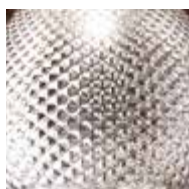

IP20

1,570 Kg / 0,0331 m³
E27 max 1x60W

€ 186

238838 ■ Fumè

3000 K
910 lm
119571 € 6,00



IP20

1,840 Kg / 0,0439 m³
E27 max 1x60W

€ 186

238920 ■ Fumè

3000 K
910 lm
119571 € 6,00

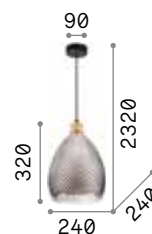

IP20

1,430 Kg / 0,0378 m³
E27 max 1x60W

€ 186

238746 ■ Fumè

3000 K
910 lm
119571 € 6,00



Bistrò

Montatura in metallo verniciato nero. Diffusore in vetro trasparente o fumè, soffiato e modellato artigianalmente.



112305



112312

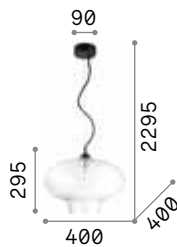

IP20

2,190 Kg / 0,0806 m³
E27 max 1x60W

€ 213

120898 Trasparen.
120904 Fumè

3000 K
910 lm

119571 € 6,00

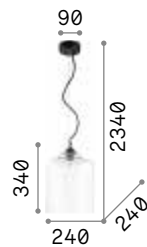

IP20

1,840 Kg / 0,0427 m³
E27 max 1x60W

€ 145

112305 Trasparen.
112312 Fumè

3000 K
910 lm

119571 € 6,00

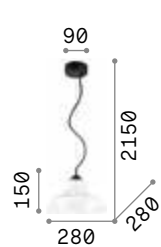

IP20

1,200 Kg / 0,0274 m³
E27 max 1x60W

€ 113

112336 Trasparen.
112343 Fumè

3000 K
910 lm

119571 € 6,00



Gretel

Montatura in metallo rifinito in vernice nera opaca con applicazione in legno naturale. Diffusori in vetro soffiato trasparente. Cavi in tessuto nero.



IP20

5,960 Kg / 0,1419 m³
E27 max 5 x 60W

€ 500

103174 ■ Nero

3000 K
910 lm
119571 € 6,00

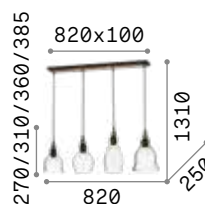

IP20

4,090 Kg / 0,0983 m³
E27 max 4 x 60W

€ 415

122557 ■ Nero

3000 K
910 lm
119571 € 6,00

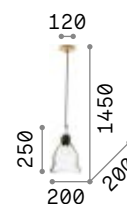

IP20

0,950 Kg / 0,0243 m³
E27 max 1 x 60W

€ 105

122564 ■ Nero

3000 K
910 lm
119571 € 6,00



Audi-10

Montatura in metallo cromato.
 Diffusore in vetro soffiato
 trasparente o fumè. Cavi in
 acciaio a lunghezza regolabile con
 dispositivi ferma cavo automatici.

LED Lampadine LED E27 8W Globo D95
 3000 K incluse. Cod. **101330/101323**



016863



103983

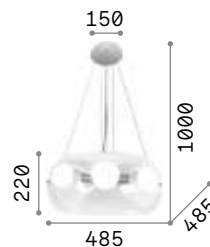

IP20 INCLUSA

5,520 Kg / 0,1044 m³
E27 max 5 x 60W

€ 425

016863 **Trasparen.**
103983 **Fumè**

3000 K
950 lm

101330 **€ 7,50**



Audi-80

Montatura in metallo cromato.
Elementi decorativi con sfere di vetro
su fili di metallo. Diffusore in vetro
soffiato trasparente o fumé. Cavi in
acciaio a lunghezza regolabile con
ferma cavo automatici.



031743



197661



9,560 Kg / 0,1289 m³
G9 max 8 x 40W

€ 620

031750 Trasparen.
197654 Fumè

3000 K
510 lm

305486 € 6,00



5,890 Kg / 0,0876 m³
G9 max 5 x 40W

€ 445

031743 Trasparen.
197661 Fumè

3000 K
510 lm

305486 € 6,00

LED

Lampadine LED G9 4W 3000 K incluse.
Cod. 209043



Madame

Rosone in metallo verniciato opaco bianco o nero. Cavo in tessuto. Diffusore con telaio metallico avvolto da nastro in tessuto di raso bianco, canvas o nero.

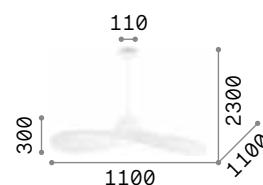

IP20

2,560 Kg / 0,2012 m³
E27 max 1x60W

€ 385

174396 ■ Bianco
219875 ■ Avorio
174402 ■ Nero

3000 K
900 lm

101354 € 8,00



174396



219875



174402



Phoenix

Montatura in metallo cromato.
Paralume con telaio in metallo e rivestimento in tessuto. Elementi decorativi con catene di ottagononi in cristallo molato. Sospensioni con cavi in acciaio regolabili in lunghezza da dispositivi automatici.



099101



101163

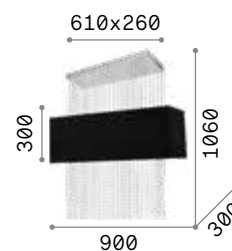

8,400 Kg / 0,1030 m³
E27 max 5 x 60W

€ 850

099101 ■ Bianco
101163 ■ Nero

3000 K
900 lm

123899 € 6,00

Pan

Montatura in metallo. Diffusori con elementi decorativi a tubi metallici di diverse misure. Cavi d'acciaio regolabili.

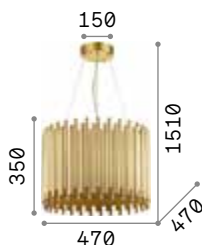

13,920 Kg / 0,1355 m³

E27 max 5 x 60W

€ 830

208817 ■ Oro

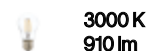

119571

€ 6,00



P. 442



Nordik

Montatura in metallo verniciato nero opaco. Paralume in lamina di PVC dorato rivestito in tessuto nero.



1,760 Kg / 0,1694 m³

E27 max 6 x 60W

€ 280

161662 ■ Nero

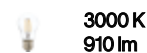

119571

€ 6,00

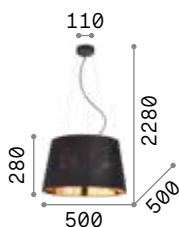

1,500 Kg / 0,1064 m³

E27 max 4 x 60W

€ 210

161648 ■ Nero

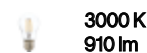

119571

€ 6,00



P. 450



P. 500



P. 560





Cylinder

Montatura in metallo. Diffusore in vetro soffiato bianco acidato. Cavi in acciaio a lunghezza regolabile con dispositivi ferma cavo automatici.

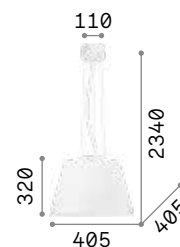

IP20

4,040 Kg / 0,0729 m³
E27 max 1x60W

€ 235

025438 Bianco

3000 K
900 lm

101354 € 8,00



P. 560

Woody

Montatura in metallo cromato.
Diffusore in PVC o in tessuto,
chiuso sul fondo da vetro
trasparente acidato. Sospensioni
con cavi regolabili in lunghezza.

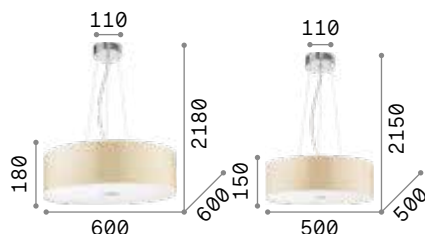

6,150 Kg / 0,1352 m³
E27 max 5 x 60W

€ 250

103242 **Bianco**
105628 **Nero**
087719 **Legno**

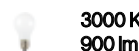

123899 **€ 6,00**



4,000 Kg / 0,0832 m³
E27 max 4 x 60W

€ 210

122236 **Bianco**
122243 **Nero**
087702 **Legno**

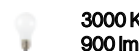

123899 **€ 6,00**



P. 304 P. 449



Wheel

Montatura circolare in metallo
smaltato. Paralume in lamina di
PVC rivestita di tessuto. Cavi in
acciaio a lunghezza regolabile con
dispositivi ferma cavo automatici.

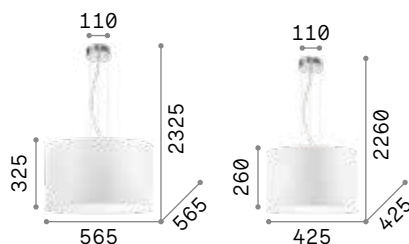

2,810 Kg / 0,1412 m³
E27 max 5 x 60W

€ 255

009698 **Bianco**

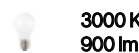

123899 **€ 6,00**



2,020 Kg / 0,0614 m³
E27 max 3 x 60W

€ 135

009681 **Bianco**

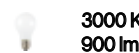

123899 **€ 6,00**



P. 305





Hilton

Montatura in cromo. Paralume in lamina di PVC rivestita in tessuto. Sul fondo, diffusore in vetro trasparente sabbiato. Sospensioni con cavi a lunghezza regolabile.

LED Lampadine LED G9 4W 3000 K incluse nel modello **075495**. Cod. **209043**

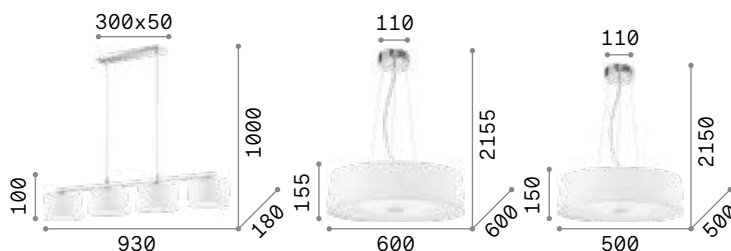

2,850 Kg / 0,0374 m³
G9 max 4x40W

€ 225

075495 Bianco



5,980 Kg / 0,1183 m³
E27 max 6x60W

€ 270

075518 Bianco



3,480 Kg / 0,0817 m³
E27 max 4x60W

€ 195

075501 Bianco

3000 K
510 lm
305486 € 6,00

3000 K
900 lm
123899 € 6,00

3000 K
900 lm
123899 € 6,00



P. 448 P. 501 P. 563



P. 302 P. 446 P. 504 P. 558

Set up

Montature in metallo verniciato a polveri o placcato. Paralumi in pvc ignifugo rivestito di tessuto. Colori montature: bianco, nero oppure nickel satinato o ottone spazzolato. Colori paralumi: beige, tortora, bianco o nero.



260013



260044



260020



260051

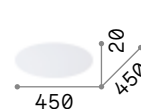
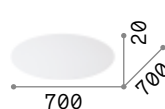
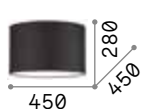
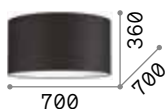

0,350 Kg / 0,0019 m³
E27 max 1x60W

€ 29

260013 Bianco
260044 Nickel
260020 Nero
260051 Ottone

1,260 Kg / 0,2131 m³

€ 116

260471 Bianco
304632 Tortora
270029 Nero
260488 Beige

0,047 Kg / 0,0221 m³

€ 85

260457 Bianco
304625 Tortora
270012 Nero
260464 Beige

0,700 Kg / 0,0259 m³

€ 50

270050 Trasparen.

0,280 Kg / 0,0108 m³

€ 30

270043 Trasparen.



3000 K
900 lm

123899

€ 6,00



Opera

Montatura in cromo. Paralume in lamina di PVC con riflessi metallizzati e rivestita da fili. Pendagli in cristallo molato. Sospensioni con cavi in acciaio a lunghezza regolabile.

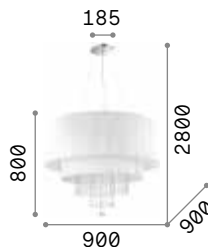

IP20

7,340 Kg / 0,3322 m³
E27 max 10 x 60W

€ 850

165011 Bianco

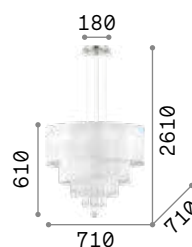

IP20

4,889 Kg / 0,1652 m³
E27 max 6 x 60W

€ 500

068299 Bianco

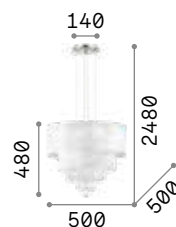

IP20

3,166 Kg / 0,0646 m³
E27 max 4 x 60W

€ 370

182179 Bianco



P. 456



P. 511



P. 565



3000 K
900 lm

123899

€ 6,00



3000 K
900 lm

123899

€ 6,00



3000 K
900 lm

123899

€ 6,00



Swan

Montatura in cromo. Corpo luce in vetro soffiato e lavorato a mano. Elementi decorativi in cristallo molato. Paralume in tessuto d'organza plissettato. Copricatena in velluto.

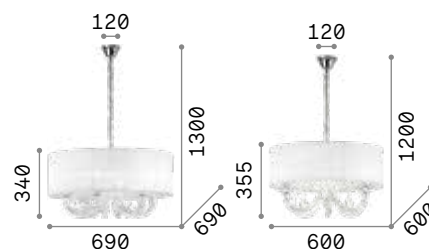

IP20

6,420 Kg / 0,2708 m³
E14 max 6x40W

€ 570

035826 Bianco

3000 K
420 lm

101217 € 2,50

IP20

4,770 Kg / 0,1632 m³
E14 max 3x40W

€ 400

035840 Bianco

3000 K
420 lm

101217 € 2,50



Calypso

Montatura in metallo cromato.
Elementi decorativi in cristallo
molato. Sospensioni con cavi in
acciaio a lunghezza regolabile da
dispositivi ferma cavo automatici.

LED Lampadine LED G9 4W 3000 K incluse
nel modello **044187**. Cod. **209043**

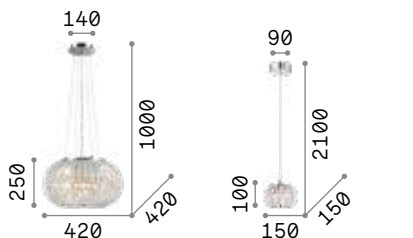

IP20

IP20

6,410 Kg / 0,0893 m³
E27 max 5 x 60W

1,130 Kg / 0,0138 m³
G9 max 1 x 40W

€ 680

€ 160

044200 Cromo

044187 Cromo

3000 K
430 lm

3000 K
510 lm

101279 € 2,60

305486 € 6,00



P. 454



King

Diffusore composto da anelli in
metallo cromato o dorato con
ottagoni di cristallo incastonati
all'interno. Sospensioni con cavi in
acciaio a lunghezza regolabile da
dispositivi automatici.

LED Lampadine LED G9 4W 3000 K incluse.
Cod. **209043**

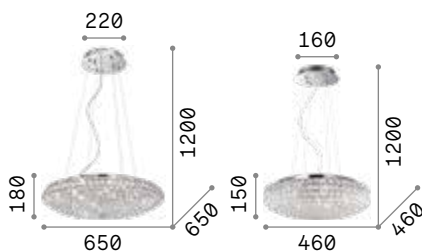

IP20

IP20

10,000 Kg / 0,1486 m³
G9 max 12 x 40W

5,300 Kg / 0,0748 m³
G9 max 7 x 40W

€ 1050

€ 670

088013 Cromo
088020 Oro

087979 Cromo

3000 K
510 lm

3000 K
510 lm

305486 € 6,00

305486 € 6,00



P. 358





Orion

Diffusore composto da anelli in metallo cromato con ottagoni di cristallo incastonati all'interno. Sospensioni con cavi in acciaio regolabili in lunghezza da dispositivi automatici.

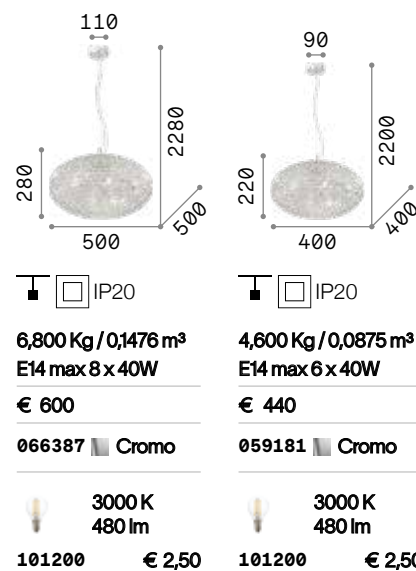

Rain

Montatura in metallo cromato.
Pendagli con elementi in cristallo
molato in varie forme e gocce finali.
Sospensioni con cavi in acciaio a
lunghezza regolabile.

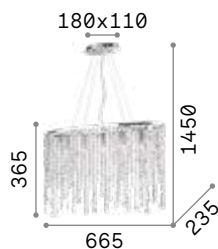

3,320 Kg / 0,0351 m³

E14 max 5x40W

€ 350

008363 Cromo

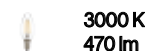

101224 € 2,50

P. 364



Giada

Montatura in metallo cromato.
Pendagli con elementi ottagonali
e puntali finali in cristallo molato.
Sospensioni con cavi in acciaio a
lunghezza regolabile.



Lampadine LED G9 4W 3000 K incluse.
Cod. **209043**

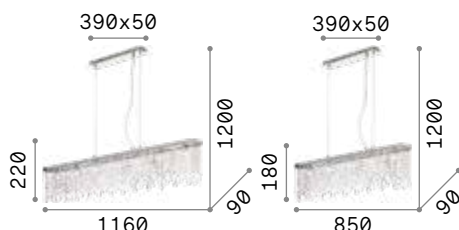

5,500 Kg / 0,0297 m³

G9 max 7x40W

€ 570

098739 Trasparen.

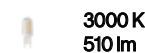

305486 € 6,00



4,000 Kg / 0,0217 m³

G9 max 5x40W

€ 425

098722 Trasparen.

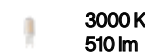

305486 € 6,00



Elisir

Montatura in metallo. Elementi decorativi a prisma in cristallo molato ambra.

LED Lampadine LED G9 4W 3000 K incluse.
Cod. 209043

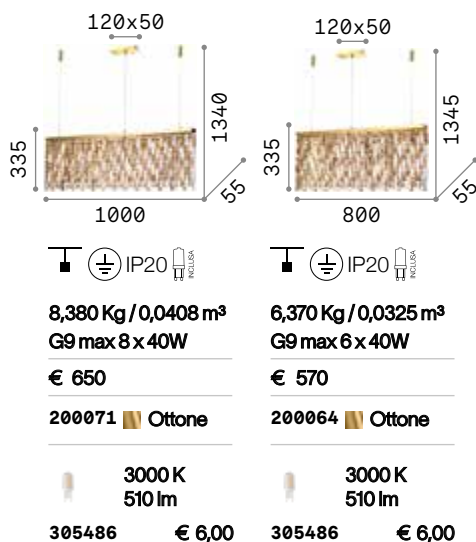

Martinez

Montatura in metallo cromato o dorato. Elementi decorativi con catene di ottagoni e barre in cristallo molato trasparente.

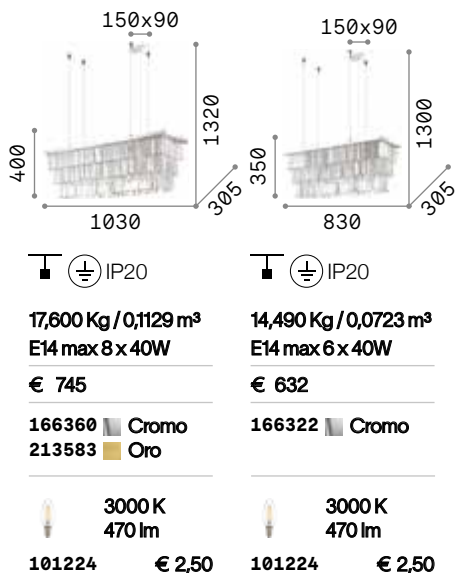

P. 366



Carlton

Montatura in metallo cromato o dorato. Elementi decorativi con catene di ottagoni e barre in cristallo molato trasparente.



166247



213521

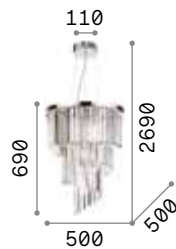

IP20

12,800 Kg / 0,1614 m³
E14 max 12 x 40W

€ 660

166247 Cromo
213521 Oro

3000 K
470 lm
101224 € 2,50

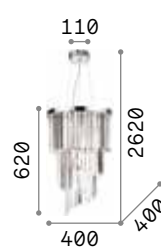

IP20

10,000 Kg / 0,1136 m³
E14 max 8 x 40W

€ 550

117737 Cromo

3000 K
470 lm
101224 € 2,50



P. 367



P. 455



Roma

Montatura e dettagli in metallo cromato. Diffusore con elementi quadrati in cristallo molato sulla fascia laterale e vetro sabbato sul fondo. Sospensioni con cavi a lunghezza regolabile.

LED

Lampadine LED G9 4W 3000 K incluse.
Cod. **209043**

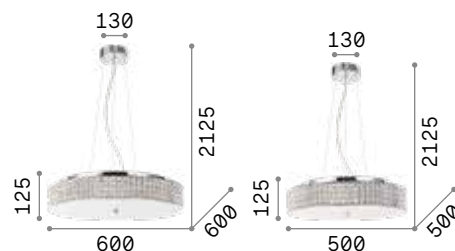

10,000 Kg / 0,1202 m³
G9 max 12 x 40W

€ 800

093062 Cromo

3000 K
510 lm

305486 € 6,00



7,100 Kg / 0,0890 m³
G9 max 9 x 40W

€ 650

093048 Cromo

3000 K
510 lm

305486 € 6,00



P. 356



P. 454



P. 510



Nabucco

Montatura in metallo con finitura oro. Elementi decorativi in cristallo trasparente molato. Quadrati nella parte superiore e a losanga in quella inferiore. Copricatena in velluto.

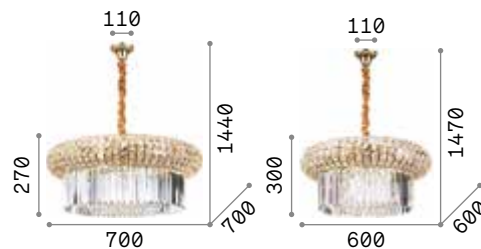

IP20

18,730 Kg / 0,2127 m³
E14 max 16 x 40W

€ 880

237800 Oro

3000 K
480 lm

101200 € 2,50

IP20

13,810 Kg / 0,1383 m³
E14 max 12 x 40W

€ 770

237794 Oro

3000 K
480 lm

101200 € 2,50



Pashà

Montatura in metallo. Diffusore composto da filari di perle in cristallo molato e fondo chiuso da vetro circolare sabbato. Cavi in acciaio a lunghezza regolabile con dispositivi fermacavo automatici.



164977



164984



P. 357 P. 454

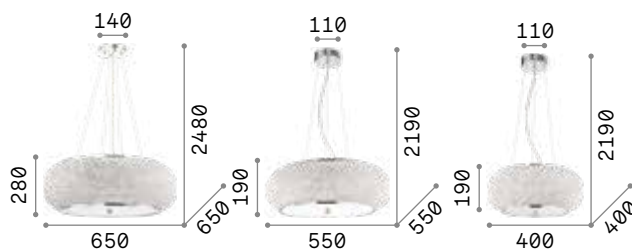

13,000 Kg / 0,1777 m³
E14 max 14 x 40W

€ 1210

164977 Cromo
164984 Oro

3000 K
480 lm

101200 € 2,50



8,500 Kg / 0,1134 m³
E14 max 10 x 40W

€ 950

082196 Cromo
082257 Oro

3000 K
480 lm

101200 € 2,50



5,350 Kg / 0,0573 m³
E14 max 6 x 40W

€ 750

082158 Cromo
082172 Oro

3000 K
480 lm

101200 € 2,50



Luxor

Montatura in metallo cromato.
Diffusore con elementi decorativi
ottagonali e rettangolari in cristallo
molato.

LED Lampadine LED G9 4W 3000 K incluse.
Cod. **209043**



12,250 Kg / 0,3097 m³
G9 max 12 x 40W

€ 1320

116235 Cromo

3000 K
510 lm

305486 € 6,00



8,780 Kg / 0,2054 m³
G9 max 8 x 40W

€ 940

116228 Cromo

3000 K
510 lm

305486 € 6,00

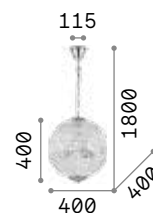

8,340 Kg / 0,1260 m³
G9 max 6 x 40W

€ 720

092911 Cromo

3000 K
510 lm

305486 € 6,00

Evasione

Pendagli in cristallo molato.
Sospensioni con cavo in acciaio a
lunghezza regolabile da dispositivo
fermacavo automatico.

LED Lampadine LED G9 4W 3000 K incluse.
Cod. 209043

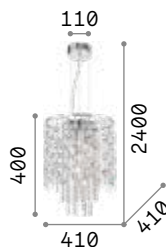
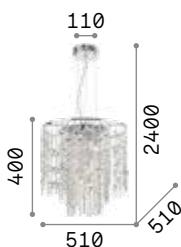

7,100 Kg / 0,1082 m³
G9 max 10 x 40W

5,900 Kg / 0,0706 m³
G9 max 8 x 40W

€ 570

€ 470

044767 Cromo

044774 Cromo

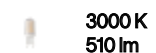
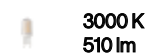

305486 € 6,00

305486 € 6,00



Audi-77

Pendagli ottagonali e tondi
in cristallo molato. Sospensioni con
cavi a lunghezza regolabile da
dispositivi automatici.

LED Lampadine LED G9 4W 3000 K incluse.
Cod. 209043

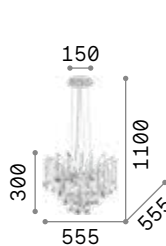

6,550 Kg / 0,1347 m³
G9 max 8 x 40W

5,230 Kg / 0,1044 m³
G9 max 6 x 40W

€ 560

€ 500

020556 Cromo

019499 Cromo

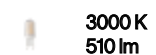
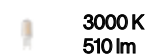

305486 € 6,00

305486 € 6,00





Dubai

Montatura in metallo con finitura cromo o ottone. Elementi decorativi con perle, ottagoni e prismi in cristallo molato trasparente.



243597



243528



P. 365



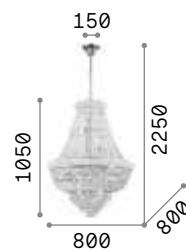

P. 455



IP20

20,000 Kg / 0,8284 m³
E14 max 24 x 28W

€ 1650

243597  Cromo
243528  Ottone

 3000 K
470 lm

101224 € 2,50

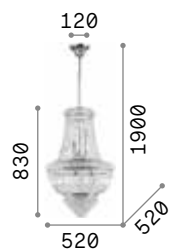

IP20

9,170 Kg / 0,2859 m³
E14 max 10 x 28W

€ 1050

215969  Cromo
207216  Ottone

 3000 K
470 lm

101224 € 2,50



Caesar

Montatura in metallo con finitura in oro o cromo. Elementi decorativi in cristallo molato ottagonali con finali a puntale.

LED Lampadine LED G9 4W 3000 K incluse.
Cod. **209043**



114279



114743

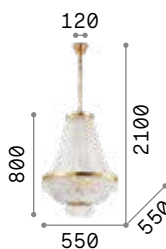

9,600 Kg / 0,2965 m³
G9 max 12 x 40W

€ 1230

114279 Cromo
114743 Oro

3000 K
510 lm

305486 € 6,00



6,700 Kg / 0,1936 m³
G9 max 9 x 40W

€ 950

041827 Cromo
114736 Oro

3000 K
510 lm

305486 € 6,00



5,100 Kg / 0,1175 m³
G9 max 6 x 40W

€ 780

033532 Cromo
114729 Oro

3000 K
510 lm

305486 € 6,00



Millennium

Montatura e dettagli in metallo verniciato con effetto ruggine. Elementi decorativi centrali in legno naturale antichizzato.

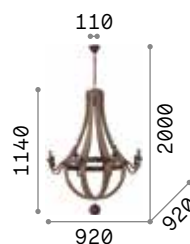

IP20

8,330 Kg / 1,0291 m³
E14 max 8 x 40W

€ 750

129709 ■ Legno

3000 K
470 lm

101224 € 2,50

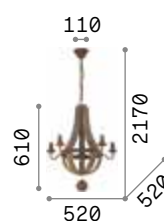

IP20

2,670 Kg / 0,2695 m³
E14 max 5 x 40W

€ 350

129921 ■ Legno

3000 K
470 lm

101224 € 2,50



Monet

Montatura in metallo con fasce circolari decorate a sbalzo. Catene con perle in legno naturale. Finitura con vernice opaca bianca.



IP20

6,700 Kg / 0,0534 m³
E14 max 6x40W

€ 520

162751 Bianco

3000 K
420 lm

101217 € 2,50

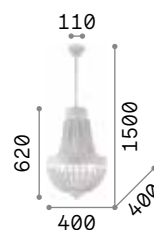

IP20

5,300 Kg / 0,0387 m³
E14 max 5x40W

€ 415

162737 Bianco

3000 K
420 lm

101217 € 2,50



Pegaso

Montatura in metallo cromato oppure ottone satinato. Corpo centrale, bobeches e pendagli in cristallo molato. Paralumi in organza. Copricatena in velluto.



059242



197739

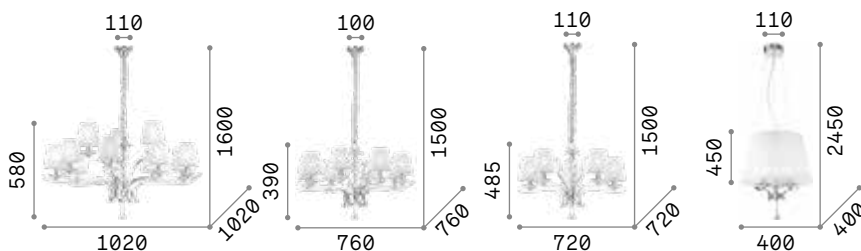

8,100 Kg / 0,3349 m³
E14 max 12 x 28W

€ 840

066431 Bianco
197746 Ottone

3000 K
370 lm

101231 € 2,50



7,900 Kg / 0,2138 m³
E14 max 8 x 28W

€ 490

059242 Bianco
197739 Ottone

3000 K
370 lm

101231 € 2,50



5,600 Kg / 0,1445 m³
E14 max 5 x 28W

€ 460

066448 Bianco
197722 Ottone

3000 K
370 lm

101231 € 2,50



3,050 Kg / 0,0758 m³
E14 max 3 x 28W

€ 230

059235 Bianco
197715 Ottone

3000 K
370 lm

101231 € 2,50



P. 457 P. 515 P. 566



Blanche

Montatura in metallo rifinito con smalto satinato bianco o nero. Paralumi in lamina di PVC rivestita di tessuto bianco o nero. Copricatena in velluto.



035581



111872

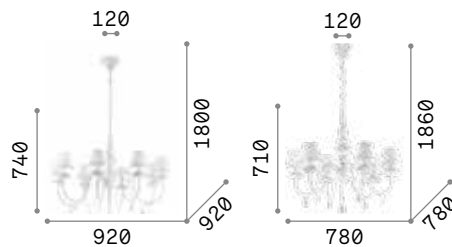

IP20

6,820 Kg / 0,1975 m³
E14 max 8 x 40W

€ 560

035574 ■ Bianco
111896 ■ Nero

3000 K
370 lm

101231 € 2,50

IP20

4,800 Kg / 0,1451 m³
E14 max 6 x 40W

€ 450

035581 ■ Bianco
111872 ■ Nero

3000 K
370 lm

101231 € 2,50



Corte

Montatura completamente in metallo modellato con lavorazione artigianale. Finitura dipinta a mano con effetto antichizzato. Disponibile nella versione bianca o ruggine.

IP20	IP20	IP20
7,100 Kg / 0,6840 m ³ E14 max 12 x 40W	5,220 Kg / 0,3169 m ³ E14 max 8 x 40W	3,180 Kg / 0,1500 m ³ E14 max 5 x 40W
€ 380	€ 260	€ 175
097664 ■ Bianco 097671 ■ Ruggine	005898 ■ Bianco 057194 ■ Ruggine	005881 ■ Bianco 057187 ■ Ruggine
3000 K 470 lm 101224 € 2,50	3000 K 470 lm 101224 € 2,50	3000 K 470 lm 101224 € 2,50



005881



057187



P. 457



Colossal

Montatura e dettagli in metallo cromato. Bracci in vetro soffiato trasparente o con interno di colore grigio o bianco avorio. Pendagli ed elementi decorativi in vetro trasparente e cristallo molato. Copricatena in velluto.



114170



081564



081526

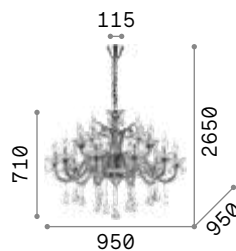

IP20

19,000 Kg / 0,2828 m³
E14 max 15 x 40W

€ 1000

114170 Trasparen.
081564 Avorio
081526 Grigio

3000 K
470 lm
101224 € 2,50

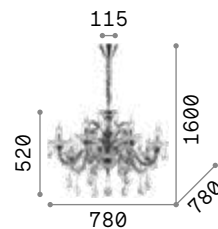

IP20

11,400 Kg / 0,1386 m³
E14 max 8 x 40W

€ 800

114187 Trasparen.
081557 Avorio
081519 Grigio

3000 K
470 lm
101224 € 2,50

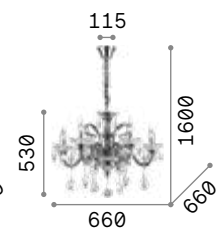

IP20

9,200 Kg / 0,1095 m³
E14 max 6 x 40W

€ 635

114194 Trasparen.
081540 Avorio
081502 Grigio

3000 K
470 lm
101224 € 2,50



Rose

Lampadario in vetro soffiato con dettagli in metallo cromato. Ottagoni e gocce in cristallo molato. Copricatena in velluto.

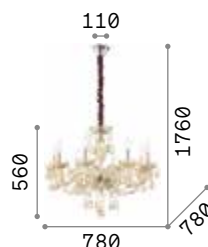

IP20

7,630 Kg / 0,1321 m³
E14 max 8 x 40W

€ 560

166889 ■ Ambra

3000 K
430 lm

101248 € 2,50



Negresco

Montatura in metallo con finitura in cromo o dorata. Bracci in vetro soffiato trasparente con interno dorato nella versione oro. Centrale composto da blocchi di cristallo molato. Elementi decorativi in vetro trasparente e cristallo molato. Copricatena in velluto.



141060



087771

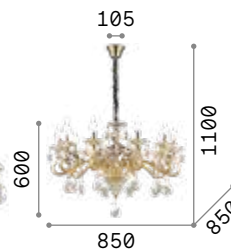

IP20

14,400 Kg / 0,1687 m³
E14 max 10 x 28W

€ 1000

141060 Trasparen.
087771 Oro

3000 K
430 lm

101248 € 2,50

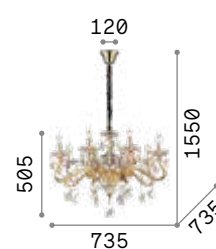

IP20

11,300 Kg / 0,1461 m³
E14 max 8 x 28W

€ 850

141053 Trasparen.
087764 Oro

3000 K
430 lm

101248 € 2,50



P. 458



Tiepolo

Lampadario in vetro soffiato lavorato a mano con dettagli in metallo cromato. Pendagli con ottagoni e gocce in cristallo molato. Copricatena in velluto.

120	120	120
IP20	IP20	IP20
7,220 Kg / 0,1080 m ³ E14 max 8 x 40W	5,120 Kg / 0,0791 m ³ E14 max 5 x 40W	3,650 Kg / 0,0370 m ³ E14 max 3 x 40W
€ 600	€ 500	€ 330
034720 Trasparen.	034713 Trasparen.	034706 Trasparen.
3000 K 370 lm	3000 K 370 lm	3000 K 370 lm
101231 € 2,50	101231 € 2,50	101231 € 2,50



Amadeus

Montatura in metallo cromato.
Elementi decorativi in vetro soffiato
e cristallo molato. Copricatena in
velluto.

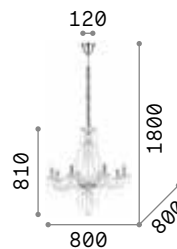

IP20

8,200 Kg / 0,1574 m³
E14 max 8 x 40W

€ 568

168777 Trasparen.

3000 K
470 lm

101224 € 2,50

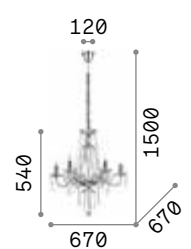

IP20

6,700 Kg / 0,1202 m³
E14 max 6 x 40W

€ 480

168753 Trasparen.

3000 K
470 lm

101224 € 2,50



Giudecca

Lampadario in vetro soffiato lavorato a mano con dettagli in metallo cromato. Pendagli con ottagoni e gocce in cristallo molato. Copricatena in velluto. Disponibile nelle finiture trasparente, nero e rosso.

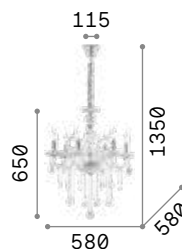

IP20

5,770 Kg / 0,1041 m³
E14 max 6 x 40W

€ 460

027821 Trasparen.
032504 Nero
027418 Rosso

3000 K
430 lm

101248 € 2,50



027821



032504



027418

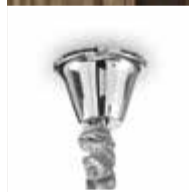

Florian

Montatura in metallo con elementi decorativi in vetro. Pendagli con ottagoni e gocce finali in cristallo molato. Disponibile nelle versioni con vetro trasparente e metallo dorato o cromato.



035604



035611

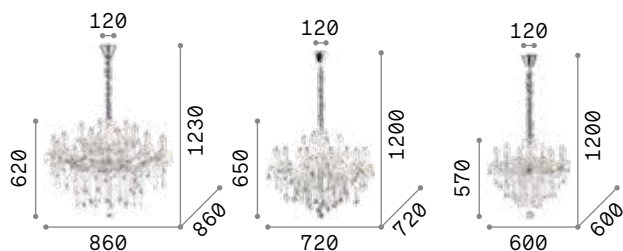

17,200 Kg / 0,3482 m³
E14 max 18 x 40W

€ 1000

075150 Cromo
075181 Oro



3000 K
470 lm

101224 € 2,50



9,760 Kg / 0,2187 m³
E14 max 12 x 40W

€ 650

035604 Cromo
035611 Oro



3000 K
470 lm

101224 € 2,50



6,380 Kg / 0,1368 m³
E14 max 6 x 40W

€ 510

035628 Cromo
035635 Oro



3000 K
470 lm

101224 € 2,50





Napoleon

Montatura in metallo cromato o dorato. Elementi decorativi in vetro soffiato e cristallo molato. Copricatena in velluto.



167244



167398

IP20	IP20	IP20
17,920 Kg / 0,4424 m³ E14 max 18 x 40W	11,260 Kg / 0,2633 m³ E14 max 12 x 40W	9,070 Kg / 0,2156 m³ E14 max 8 x 40W
€ 1000	€ 635	€ 600
167268 Cromo 167411 Oro	167251 Cromo 167404 Oro	167244 Cromo 167398 Oro
3000 K 470 lm	3000 K 470 lm	3000 K 470 lm
101224 € 2,50	101224 € 2,50	101224 € 2,50



Gioconda

Corpo luce in fusione di metallo con finitura oro o argento antico. Pendagli ottagonali e tondi in cristallo molato. Copricatena in velluto.

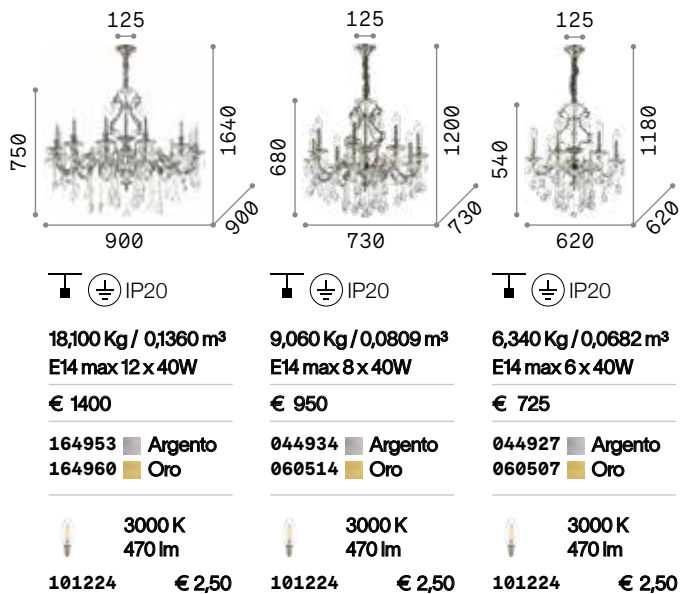

164953



164960



P. 459

Impero

Corpo luce in fusione di metallo con finitura argento antico. Elementi decorativi in cristallo molato. Copricatena in velluto.

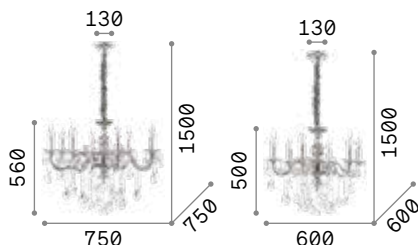

IP20

7,500 Kg / 0,0454 m³
E14 max 8 x 40W

€ 850

014395 ■ Argento

3000 K
470 lm

101224 € 2,50

IP20

5,000 Kg / 0,0340 m³
E14 max 6 x 40W

€ 550

002408 ■ Argento

3000 K
470 lm

101224 € 2,50

Strauss

Montatura e dettagli in metallo con finitura oro. Bracci in vetro soffiato trasparente. Elementi decorativi in cristallo ambrato. Copricatena in velluto.

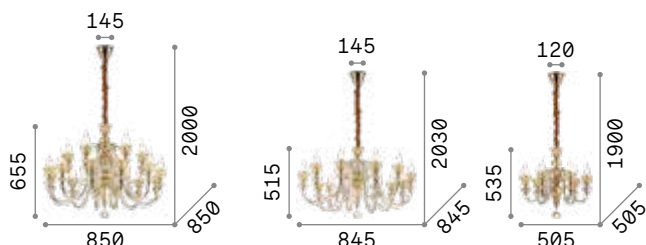

IP20

20,700 Kg / 0,4508 m³
E14 max 18 x 40W

€ 1400

140629 ■ Oro

3000 K
430 lm

101248 € 2,50

IP20

14,930 Kg / 0,3414 m³
E14 max 12 x 40W

€ 1050

140612 ■ Oro

3000 K
430 lm

101248 € 2,50

IP20

7,410 Kg / 0,1420 m³
E14 max 6 x 40W

€ 575

140605 ■ Oro

3000 K
430 lm

101248 € 2,50



P. 459

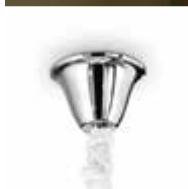

Casanova

Lampadario in vetro soffiato e lavorato a mano con copri portalampade e dettagli in metallo cromato. Disponibile trasparente o fumè. Copricatena in velluto.

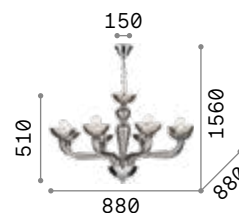

IP20

9,210 Kg / 0,1592 m³
E14 max 8 x 40W

€ 750

044255 ■ Trasparen.
095615 ■ Fumè

3000 K
480 lm

101200 € 2,50



044255

095615



Doge

Lampadario in vetro, trasparente o bianco, soffiato e lavorato a mano. Montatura e dettagli in metallo rifinito in cromo.



044422

113678

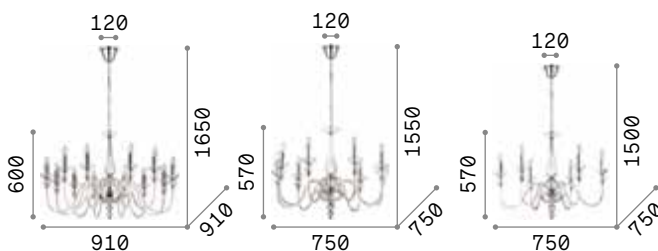

9,400 Kg / 0,3064 m³
E14 max 12 x 40W

€ 690

168906 Trasparen.

6,660 Kg / 0,2229 m³
E14 max 9 x 40W

€ 580

044453 Trasparen.

5,240 Kg / 0,1602 m³
E14 max 6 x 40W

€ 490

044422 Trasparen.
113678 Bianco

3000 K
470 lm

101224 € 2,50



3000 K
470 lm

101224 € 2,50



3000 K
470 lm

101224 € 2,50



Danieli

Montatura in metallo cromato o dorato. Elementi decorativi in vetro soffiato trasparente o ambrato. Copricatena in velluto.

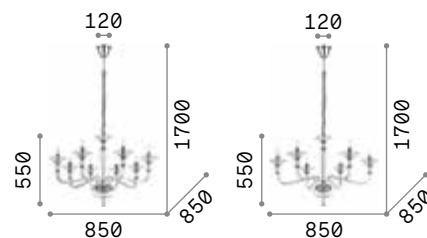

IP20

7,510 Kg / 0,2048 m³
E14 max 8 x 40W

€ 650

159980 Trasparen.
159973 Ambra

3000 K
480 lm

101200 € 2,50

IP20

3,840 Kg / 0,1759 m³
E14 max 6 x 40W

€ 600

159959 Trasparen.
159942 Ambra

3000 K
480 lm

101200 € 2,50



159980



159973



Brigitta

Lampadario in vetro soffiato trasparente o ambrato, lavorato artigianalmente con montatura in metallo e copricatena in velluto.

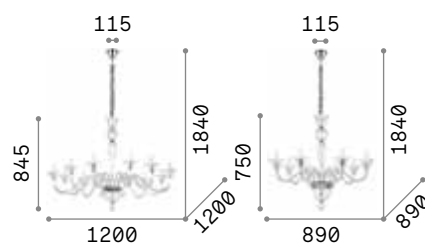

IP20

IP20

12,500 Kg / 0,2380 m³
E14 max 12 x 40W

7,700 Kg / 0,1797 m³
E14 max 8 x 40W

€ 1000

€ 750

199375 Trasparen.
199405 Ambra

199382 Trasparen.
199412 Ambra

3000 K
480 lm

3000 K
480 lm

101200 € 2,50

101200 € 2,50



199382



199412

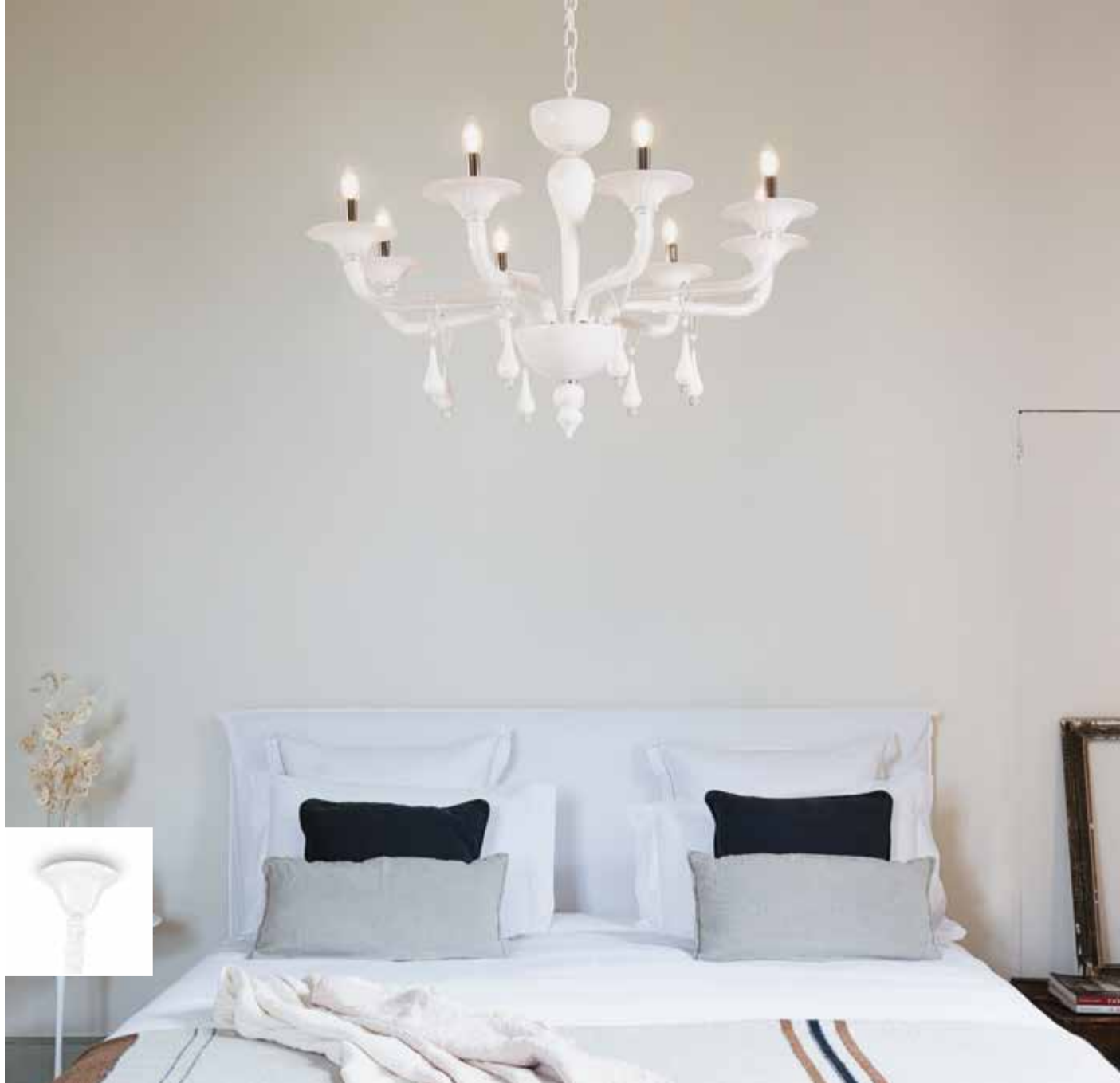

Miramare

Lampadario in vetro trasparente e bianco soffiato e lavorato a mano. Copri portalampade e dettagli in metallo cromato. Copricatena in velluto.

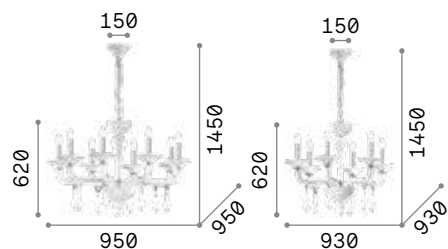

IP20

8,800 Kg / 0,1653 m³
E14 max 8 x 40W

€ 580

068190 Bianco

3000 K
470 lm

101224 € 2,50

IP20

8,100 Kg / 0,1437 m³
E14 max 6 x 40W

€ 500

068183 Bianco

3000 K
470 lm

101224 € 2,50



Bon Bon

Montatura con bracci in fusione di metallo rifinito con vernice opaca bianca o nera. Bobeche in vetro soffiato nella versione bianca, in metallo in quella nera. Copricatena in velluto.

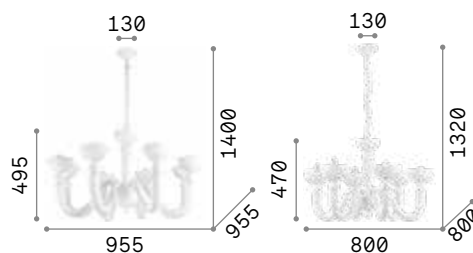

IP20

11,710 Kg / 0,1953 m³
E14 max 8 x 28W

€ 900

094007 ■ Bianco

3000 K
420 lm

101217 € 2,50

IP20

8,110 Kg / 0,1547 m³
E14 max 6 x 28W

€ 630

093994 ■ Bianco
140339 ■ Nero

3000 K
420 lm

101217 € 2,50



093994



140339



Firenze

Corpo luce in resina. Bracci e foglie in metallo modellato artigianalmente. Decorato a mano con foglia d'oro e antichizzato.



012872



020839

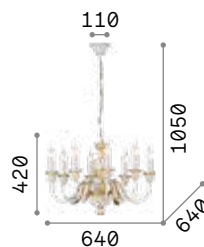

IP20

6,440 Kg / 0,0842 m³
E14 max 8 x 40W

€ 510

012872 Bianco
020839 Oro

3000 K
430 lm

101248 € 2,50

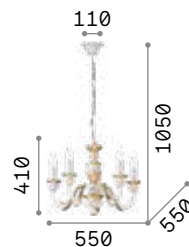

IP20

4,360 Kg / 0,0609 m³
E14 max 5 x 40W

€ 400

012865 Bianco
020822 Oro

3000 K
430 lm

101248 € 2,50



P. 460



P. 509



P. 567



Justine

Rosone e montatura in metallo con bracci in fusione. Rifinito con vernice opaca bianca. Copricatena in velluto.

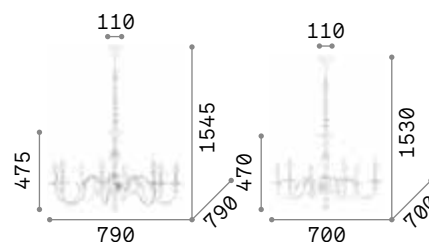

IP20

4,550 Kg / 0,3281 m³
E14 max 8 x 40W

€ 495

197524 Bianco

3000 K
430 lm

101248 € 2,50

IP20

3,440 Kg / 0,2592 m³
E14 max 6 x 40W

€ 390

197500 Bianco

3000 K
430 lm

101248 € 2,50



Vanity

Montatura in metallo dorato con dettagli nero opaco. Elementi decorativi in cristallo molato. Copricatena in velluto.

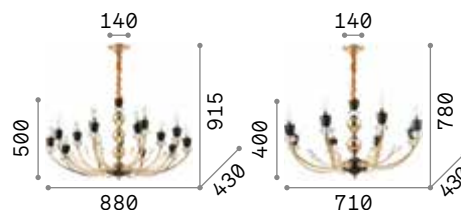

IP20

8,850 Kg / 0,2878 m³
E14 max 15 x 40W

€ 680

206639 Oro

3000 K
470 lm

101224 € 2,50

IP20

4,940 Kg / 0,1454 m³
E14 max 8 x 40W

€ 420

206622 Oro

3000 K
470 lm

101224 € 2,50



Harem

Montatura con decori in rilievo in metallo brunito e ottagononi in cristallo molato incastonati. Diffusori in vetro soffiato trasparente leggermente ambrato con pendaglio a nappa. Copricatena in velluto.

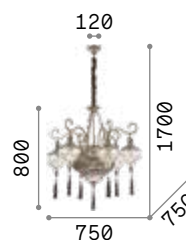

IP20

8,550 Kg / 0,2571 m³
E27 max 9x42W

€ 1150

116006 ■ Brunito

3000 K
910 lm

119571 € 6,00

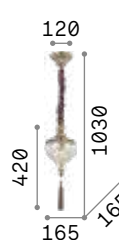

IP20

0,980 Kg / 0,0228 m³
E27 max 1x42W

€ 170

115979 ■ Brunito

3000 K
910 lm

119571 € 6,00



P. 462



Chalet

Montatura con struttura portante in metallo. Elementi decorativi in resina lavorata artigianalmente e dipinta a mano come fedele riproduzione di corna e legno intagliato.

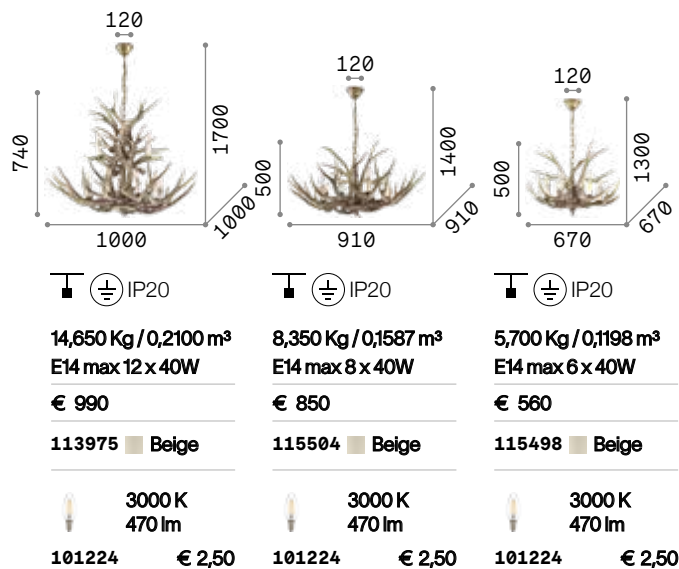



Driftwood

Rosone in metallo. Struttura sospesa di rami naturali. Copri portalampade in metallo spazzolato.

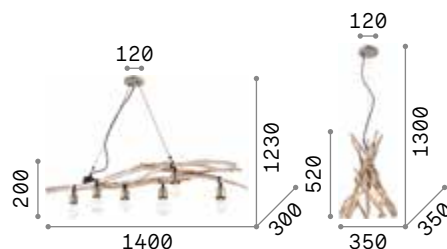

□ IP20

4,500 Kg / 0,1402 m³
E27 max 6x60W

€ 430

180922 ■ Legno

💡 2200 K
370 lm

151687 € 4,60

⊕ IP20

1,240 Kg / 0,0599 m³
E27 max 1x60W

€ 315

129600 ■ Legno

💡 2200 K
370 lm

151687 € 4,60



P. 506



P. 554



Haunt

Rosone in metallo verniciato bianco opaco. Cavo in tessuto. Diffusore con cesto in vimini al naturale o verniciato in bianco.



159256



159812

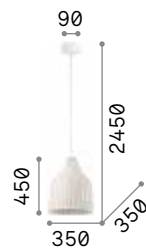

IP20

0,460 Kg / 0,0622 m³
E27 max 1x60W

€ 180

159256 Bianco
159812 Legno

3000 K
1020 lm

101347 € 8,00



Canapa

Montatura in metallo verniciato.
Cavi elettrici e diffusori rivestiti in
corda di canapa naturale.

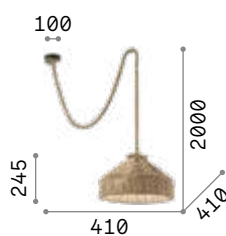

IP20

2,190 Kg / 0,0944 m³
E27 max 1x15W

€ 180

134833 ■ Corda

3000 K
910 lm
119571 € 6,00



IP20

0,650 Kg / 0,0063 m³
E27 max 2x15W

€ 60

134840 ■ Corda

3000 K
910 lm
119571 € 6,00

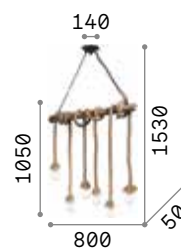

IP20

2,410 Kg / 0,0254 m³
E27 max 6x15W

€ 180

134826 ■ Corda

3000 K
910 lm
119571 € 6,00



Norma

Montatura in metallo con finitura in cromo o in brunito. Diffusore composto da lastre di vetro trasparente con bordo molato. Copricatena in velluto.

094786



005911

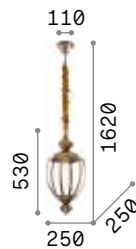

IP20

2,620 Kg / 0,0286 m³
E27 max 1x 60W

€ 210

094786 Cromo
005911 Brunito

3000 K
430 lm

101279 € 2,60



Deca

Montatura in metallo con finitura in brunito. Diffusore in lastre di vetro trasparente, apribile per sostituzione lampadina.

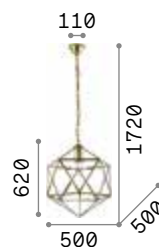

IP20

6,720 Kg / 0,2288 m³
E27 max 1x60W

€ 440

168869 ■ Brunito

2200 K
480 lm

151724 € 8,00

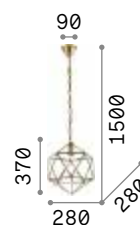

IP20

2,580 Kg / 0,0589 m³
E27 max 1x60W

€ 225

168852 ■ Brunito

2200 K
500 lm

151717 € 8,00

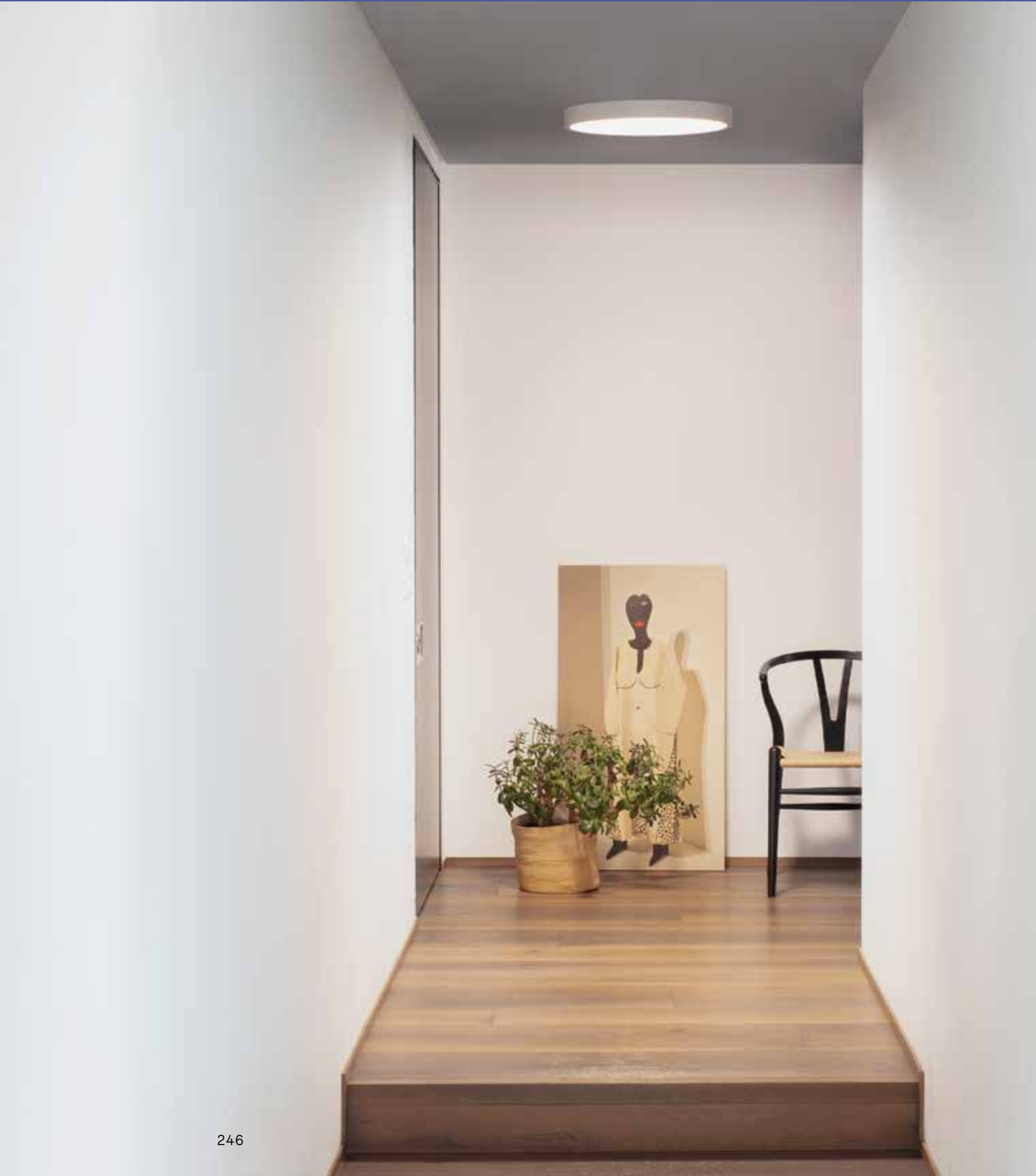

Interni

Lampade da soffitto

Indice alfabetico

Admiral	359	Halo	268	Penta	352
Alfa	330	Hermes	350	Perlage	334
Angolo	344	Iride	353	Petit	322
Arizona	288	Karol	256	Ping Pong	348
Armony	360	King	358	Planet	298
Atlas	341	Kubiko	314	Profilo	328
Atrium	289	Lana	306	Rain	364
Aura	309	Level	286	Ray	270
Binomio	349	Lingotto	345	Relax	280
Birds	337	Look	310	Ritz	305
Candy	290	Lumiere	346	Roma	356
Carlton	367	Magnolia	365	Royal	364
Carta	293	Mapa Bianco	292	Rudy	326
Celine	279	Maracas	331	Set Up	302
Clara	278	Martinez	366	Shell	307
Cloud	294	Mix Up	300	Simply	306
Compo	355	Mood	315	Sky	311
Corolla	295	Moonlight	363	Slem	330
Cosmopolitan	343	Mouse	324	Smarties	287
Cotton	291	Multiflex	339	Spark	342
Daisy	354	Neve	362	Spike	317
Dot	316	Ninfea	351	Spot	324
Dubai	365	Nitro	312	Toby	321
Dynamite	320	Nodi	332	Totem	281
Flat	278	Nodino	333	Tower	318
Fly	258	Oak	318	Triumph	336
Frame	254	Oby	325	Univers R.	274
Geko	285	Ocean	279	Universal S.	276
Gemini	282	Octopus	339	Wheel	305
Gemma	308	Oracle Slim	252	Winery	323
Gingle	284	Ovalino	294	Woody	304
Glim	329	Oz	257	Ziggy	296
Glory	286	Pashà	357		
Gourmet	340	Pauline	338		



Perlage

Pag 334



OracleSlim 252



Frame 254



Clara 278



Flat 278



Glory 286



Level 286



Ovalino 294



Cloud 294



Ritz 305



Simply 306

new



Kubiko 314



Mood 315

new



Toby 321



Petit 322













































Alfa 330



Slem 330































Interni

Indice icone

				 new	 new	 new
Karol 256	Oz 257	Fly 258	Halo 268	Ray 270	Universal R. 274	Universal S. 276
				 new		
Celine 279	Ocean 279	Relax 280	Totem 281	Gemini 282	Gingle 284	Geko 285
		 new		 new		 new
Smarties 287	Arizona 288	Atrium 289	Candy 290	Cotton 291	MapaBianco 292	Carta 293
 new	 new	 new				
Corolla 295	Ziggy 296	Planet 298	Mix Up 300	Set Up 302	Woody 304	Wheel 305
						 new
Lana 306	Shell 307	Gemma 308	Aura 309	Look 310	Sky 311	Nitro 312
 new	 new					
Dot 316	Spike 317	Oak 318	Tower 318	Lika 319	Dynamite 320	Play 321
				 new	 new	
Winery 323	Mouse 324	Spot 324	Oby 325	Rudy 326	Profilo 328	Glim 329
			 new			
Maracas 331	Nodi 332	Nodino 333	Perlage 334	Triumph 336	Birds 337	Pauline 338

Interni

Indice icone

			 new		 new	
Multiflex 339	Octopus 339	Gourmet 340	Atlas 341	Spark 342	Cosmopolitan 343	Angolo 344
 new	 new	 new	 new	 new		 new
Lingotto 345	Lumiere 346	Ping Pong 348	Binomio 349	Hermes 350	Ninfea 351	Penta 352
 new						
Iride 353	Daisy 354	Compo 355	Roma 356	Pashà 357	King 358	Admiral 359
 new						
Armony 360	Neve 362	Moonlight 363	Royal 364	Rain 364	Magnolia 365	Dubai 365
						
Martinez 366	Carlton 367					



Binomio

Pag 349



Oracle Slim

Lampada da soffitto costituita da una montatura sottile in alluminio verniciato bianco o nero opaco e diffusore opale in policarbonato. Disponibile nel modello circolare in tre dimensioni diverse. LED integrati, disponibile in temperatura di colore 3000 K, CRI ≥ 80, durata utile LED 20.000 h, protezione IP20, classe isolamento II.

LED Sorgente luminosa LED 3000 K, 20.000 h di durata.

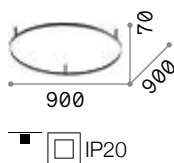

■ □ IP20

1,700 Kg / 0,1345 m³
LED 55W / 5300 lm

€ 295

266015 □ Bianco
266022 ■ Nero

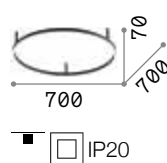

■ □ IP20

1,430 Kg / 0,0852 m³
LED 38W / 4300 lm

€ 240

265995 □ Bianco
266008 ■ Nero

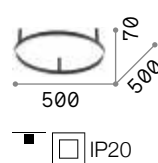

■ □ IP20

1,240 Kg / 0,0455 m³
LED 32W / 3150 lm

€ 195

265971 □ Bianco
265988 ■ Nero



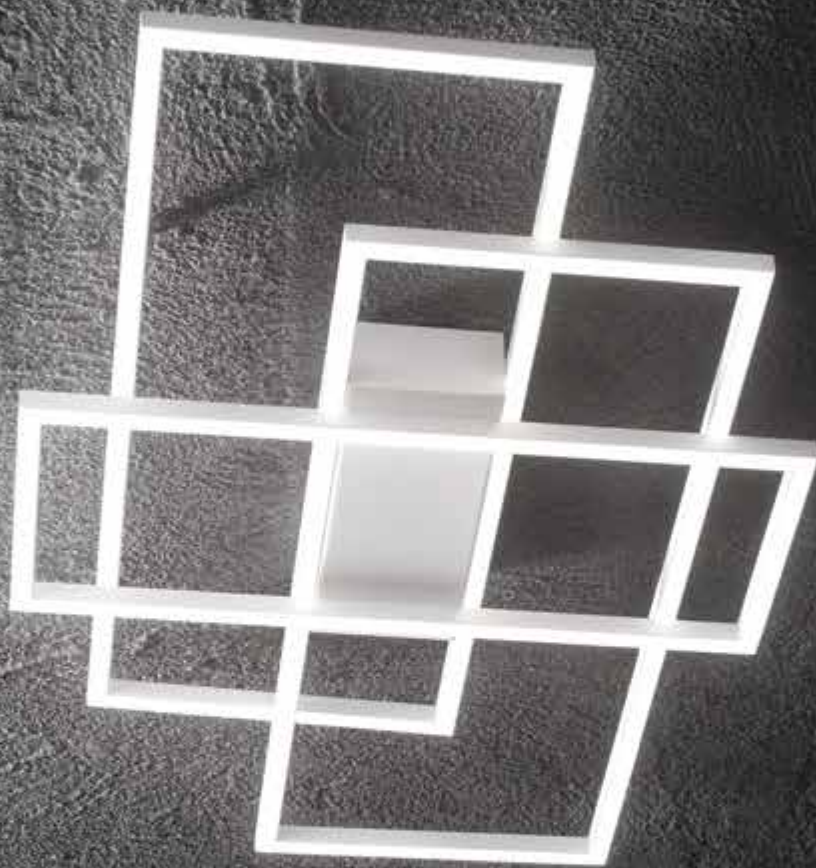

Frame

Base e montatura in metallo verniciato bianco opaco o nero opaco. Diffusori in materiale plastico colore opale. Emissione luce diretta.

LED Sorgente luminosa LED 3000 K, 30.000 h di durata.

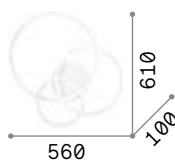
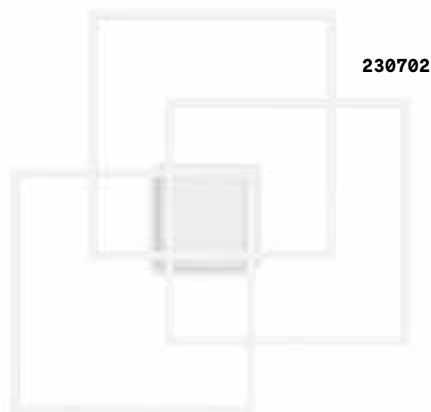
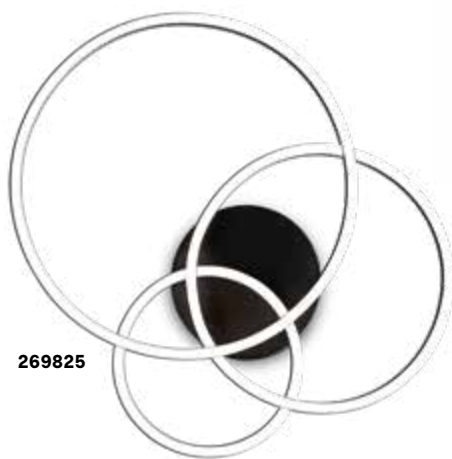

■ ■ □ IP20

1,600 Kg / 0,0458 m³
LED 41W / 5250 lm

€ 320

255019 ■ Bianco
269825 ■ Nero

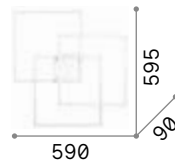

■ ■ □ IP20

1,430 Kg / 0,0530 m³
LED 35W / 4950 lm

€ 320

230702 ■ Bianco
270678 ■ Nero

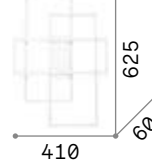

■ ■ □ IP20

1,240 Kg / 0,0264 m³
LED 31W / 4250 lm

€ 290

230726 ■ Bianco
270661 ■ Nero





Karol

Corpo luce in metallo verniciato bianco opaco. Diffusore in materiale plastico colore opale.

LED Sorgente luminosa LED 4000 K, 50.000 h di durata.

760	650
200	180
⊕ IP20	⊕ IP20
3,430 Kg / 0,185 m ³ LED 99W / 12200 lm	2,300 Kg / 0,0901 m ³ LED 78W / 10500 lm
€ 515	€ 375
227832 Bianco	227825 Bianco



Oz

Base e montatura in metallo verniciato a polveri o placcato. Diffusore in gomma opale. Disponibile nelle finiture bianco, nero o ottone spazzolato. Disponibile anche in versione dimmerabile DALI/Push.

LED Sorgente luminosa LED 3000 K, 30.000 h di durata.

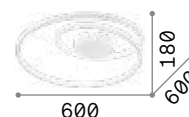
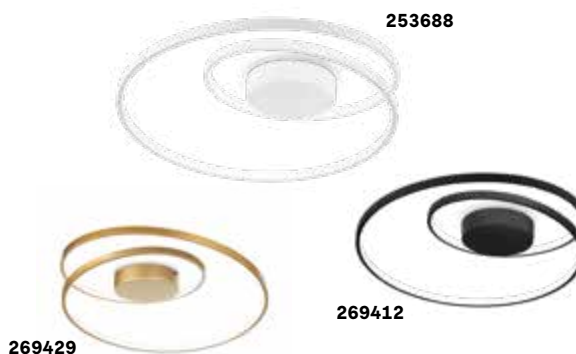

IP20

1,500 Kg / 0,0354 m³
LED 48W / 5200 lm

€ 320 On-Off / 395 Dalì

253688	Bianco	On-Off
304519	Bianco	Dalì/Push
269412	Nero	On-Off
304526	Nero	Dalì/Push
269429	Ottone	On-Off
304533	Ottone	Dalì/Push

Fly

Famiglia di lampade a plafone con base circolare, disponibile in quattro diametri diversi (350 mm, 450 mm, 600 mm, 900 mm) oltre che nella variante SLIM dall'altezza più compatta. Corpo luce in alluminio verniciato a polveri in finitura bianco RAL 9016 e nero RAL 9004, ottica arretrata (FLY PL) oppure a filo (FLY SLIM) con diffusore in PMMA microprismatizzato con controllo dell'abbagliamento (UGR < 19). La lampada è predisposta per essere integrata con il modulo accessorio uplight per la componente di illuminazione indiretta. Sorgente luminosa a LED integrati; disponibile in temperatura di colore 3000 K e 4000 K; CRI ≥ 80; durata utile LED 50.000 h; protezione IP40, classe isolamento I. Driver incluso, integrato nel corpo illuminante, disponibile in versione dimmerabile 1-10V, DALI e Push. Sistema adatto per ambienti dove richiama un'illuminazione professionale e uniforme, ad esempio UFFICI e spazi COMMERCIALI. L'elevata resa cromatica lo rende ideale anche per gli spazi espositivi e la valorizzazione della merce in showroom e aree vendita nel settore RETAIL.

PRO

Prodotto ad alto contenuto tecnologico, elevata qualità dei materiali, destinato ad uso professionale.

IP40

Grado di protezione IP40.

Sorgente	LED SMD
Potenza	18W / 26W / 53W / 65W
Driver incluso	On/Off
Driver disponibili	1-10V / DALI / Push
MacAdam	SDCM 3
CCT	3000 K / 4000 K
CRI	≥80
UGR	<19
Durata LED	50.000 h
Classe isolamento	I
IP	40
Materiale	Alluminio
Garanzia	5 anni





Fly

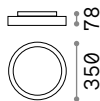

3,000 Kg/0,0160 m³

LED SMD SAMSUNG Driver TRIDONIC ON/OFF incluso

Potenza	Angolo	Lumen	CCT	Finitura	Codice	€
18 W	87°	2650 lm	3000 K	Bianco	270272	315
				Nero	306575	315
		2800 lm	4000 K	Bianco	270289	315
				Nero	306582	315

DIMMABLE DRIVER Non incluso/Optional

	Potenza	Output	Misura	Codice	€
1-10V/Push	20 W	500 mA	108x22x52 mm	270333	65
DALI	20 W	500 mA	108x22x52 mm	270364	85

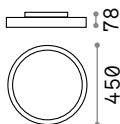

3,700 Kg/0,0250 m³

LED SMD SAMSUNG Driver TRIDONIC ON/OFF incluso

Potenza	Angolo	Lumen	CCT	Finitura	Codice	€
26 W	87°	3700 lm	3000 K	Bianco	254272	420
				Nero	306599	420
		3900 lm	4000 K	Bianco	270296	420
				Nero	306605	420

DIMMABLE DRIVER Non incluso/Optional

	Potenza	Output	Misura	Codice	€
1-10V/Push	32 W	700 mA	94x21x67 mm	270586	75
DALI/Push	38 W	700 mA	94x21x67 mm	270593	95

UPLIGHT Non incluso/Optional



Modello	Potenza	Angolo	Lumen	CCT	Codice	€
ø 35	12 W	120°	1600 lm	3000 K	270258	85
			1700 lm	4000 K	270395	85
ø 45	12 W	120°	1600 lm	3000 K	270258	85
			1700 lm	4000 K	270395	85

KIT PENDANT



Necessario	Finitura	Codice	€
No	Bianco	254289	50
	Nero	307244	50



Light beam: WIDE

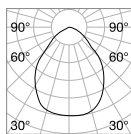

m	lx	Øm
1	2945	1,90
2	736	3,80
3	327	5,60
4	184	7,50
5	116	9,40

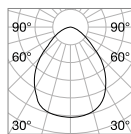

m	lx	Øm
1	1562	1,90
2	390	3,70
3	174	5,60
4	98	7,50
5	62	9,40



CRI≥80 18W 87° 2650lm 3000K

CRI≥80 26W 87° 3700lm 3000K



Fly

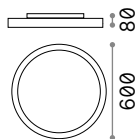

4,500 Kg/0,0423 m³

LED SMD SAMSUNG Driver TRIDONIC ON/OFF incluso

Potenza	Angolo	Lumen	CCT	Finitura	Codice	€
53 W	87°	7500 lm	3000 K	Bianco	270302	610
				Nero	292205	610
		8000 lm	4000 K	Bianco	270319	610
				Nero	306612	610

DIMMABLE DRIVER Non incluso/Optional

	Potenza	Output	Misura	Codice	€
1-10V	60 W	1400 mA	124 x 23 x 82 mm	270340	112
DALI / Push	60 W	1400 mA	125 x 28 x 85 mm	270371	135

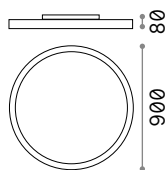

6,900 Kg/0,0903 m³

LED SMD SAMSUNG Driver TRIDONIC ON/OFF incluso

Potenza	Angolo	Lumen	CCT	Finitura	Codice	€
65 W	87°	9400 lm	3000 K	Bianco	270326	1180
				Nero	306629	1180
		9900 lm	4000 K	Bianco	270241	1180
				Nero	306636	1180

DIMMABLE DRIVER Non incluso/Optional

	Potenza	Output	Misura	Codice	€
1-10V	68 W	1400 mA	130 x 25 x 75 mm	270357	125
DALI / Push	100 W	1400 mA	140 x 30 x 100 mm	270388	180

UPLIGHT Non incluso/Optional



Modello	Potenza	Angolo	Lumen	CCT	Codice	€
ø 60	18 W	120°	2650 lm	3000 K	270401	150
			2750 lm	4000 K	270265	150
ø 90	25 W	120°	3650 lm	3000 K	271002	225
			3850 lm	4000 K	270715	225

KIT PENDANT



Necessario	Finitura	Codice	€
No	Bianco	254289	50
	Nero	307244	50



Light beam: WIDE

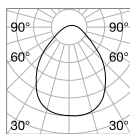

m	lx	øm
1	2945	1,90
2	736	3,80
3	327	5,60
4	184	7,50
5	116	9,40

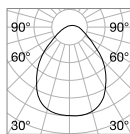

m	lx	øm
1	3991	1,90
2	998	3,90
3	443	5,80
4	249	7,80
5	160	9,70



CRI≥80 53W 87° 7500lm 3000K

CRI≥80 65W 87° 9400lm 3000K



Fly Slim

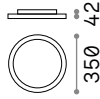

LED SMD SAMSUNG Driver TRIDONIC ON/OFF incluso

Potenza	Angolo	Lumen	CCT	Finitura	Codice	€
18 W	87°	2650 lm	3000 K	Bianco	306643	295
		2800 lm	4000 K	Bianco	306650	295

2,700 Kg/0,0105 m³

DIMMABLE DRIVER Non incluso/Optional

	Potenza	Output	Misura	Codice	€
1-10V/Push	20 W	500 mA	108x22x52 mm	270333	65
DALI	20 W	500 mA	108x22x52 mm	270364	85

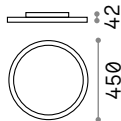

LED SMD SAMSUNG Driver TRIDONIC ON/OFF incluso

Potenza	Angolo	Lumen	CCT	Finitura	Codice	€
26 W	87°	3700 lm	3000 K	Bianco	292236	390
		3900 lm	4000 K	Bianco	306667	390

3,750 Kg/0,0170 m³

DIMMABLE DRIVER Non incluso/Optional

	Potenza	Output	Misura	Codice	€
1-10V/Push	32 W	700 mA	94x21x67 mm	270586	75
DALI/Push	38 W	700 mA	94x21x67 mm	270593	95

UPLIGHT Non incluso/Optional



Modello	Potenza	Angolo	Lumen	CCT	Codice	€
ø 35	12 W	120°	1600 lm	3000 K	270258	85
			1700 lm	4000 K	270395	85
ø 45	12 W	120°	1600 lm	3000 K	270258	85
			1700 lm	4000 K	270395	85

KIT PENDANT



Necessario	Finitura	Codice	€
No	Bianco	254289	50



Light beam: WIDE

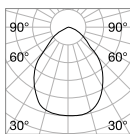

m	lx	Øm
1	1066	1,90
2	267	3,70
3	118	5,60
4	67	7,50
5	43	9,40

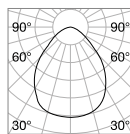

m	lx	Øm
1	1511	1,90
2	378	3,80
3	168	5,70
4	94	7,60
5	60	9,50



CRI≥80 18W 87° 2650lm 3000K

CRI≥80 26W 87° 3700lm 3000K



Fly Slim

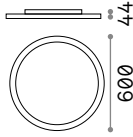

LED SMD SAMSUNG Driver TRIDONIC ON/OFF incluso

Potenza	Angolo	Lumen	CCT	Finitura	Codice	€
53 W	87°	7500 lm	3000 K	Bianco	292250	575
		8000 lm	4000 K	Bianco	306674	575

5,800 Kg/0,0699 m³

DIMMABLE DRIVER Non incluso/Optional

	Potenza	Output	Misura	Codice	€
1-10V	60 W	1400 mA	124 x 23 x 82 mm	270340	112
DALI / Push	60 W	1400 mA	125 x 28 x 85 mm	270371	135

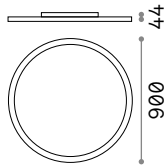

LED SMD SAMSUNG Driver TRIDONIC ON/OFF incluso

Potenza	Angolo	Lumen	CCT	Finitura	Codice	€
65 W	87°	9400 lm	3000 K	Bianco	306681	1125
		9900 lm	4000 K	Bianco	306698	1125

13,000 Kg/0,1448 m³

DIMMABLE DRIVER Non incluso/Optional

	Potenza	Output	Misura	Codice	€
1-10V	68 W	1400 mA	130 x 25 x 75 mm	270357	125
DALI / Push	100 W	1400 mA	140 x 30 x 100 mm	270388	180

UPLIGHT Non incluso/Optional



Modello	Potenza	Angolo	Lumen	CCT	Codice	€
ø 60	18 W	120°	2650 lm	3000 K	270401	150
			2750 lm	4000 K	270265	150
ø 90	25 W	120°	3650 lm	3000 K	271002	225
			3850 lm	4000 K	270715	225

KIT PENDANT



Necessario	Finitura	Codice	€
No	Bianco	254289	50



Light beam: WIDE

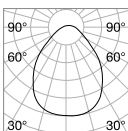

m	lx	øm
1	3000	1,90
2	750	3,80
3	333	5,70
4	187	7,60
5	120	9,50

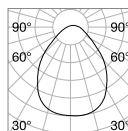

m	lx	øm
1	3857	1,90
2	964	3,90
3	429	5,80
4	241	7,80
5	154	9,70



CRI≥80 53W 87° 7500lm 3000K

CRI≥80 65W 87° 9400lm 3000K



Halo

Lampada a plafone con base circolare e corpo luce in alluminio verniciato a polveri. Diffusore opale in policarbonato. Disponibile in tre diversi diametri di colore bianco. Sorgente luminosa a LED integrati con binning iniziale ≤ 2-Step MacAdam; disponibile in temperatura di colore 3000 K e 4000 K; CRI ≥ 80; durata utile LED 35.000 h; protezione IP20, classe isolamento I.

Sorgente	LED SMD	Classe	I
Potenza	26W / 32W / 46W	isolamento	
Driver incluso	On/Off	IP	20
Driver disponibili	No	Materiale	Alluminio
CCT	3000 K / 4000 K		
CRI	≥80		
Durata LED	35.000 h		



Luce indiretta inclusa.



2,750 Kg/0,0177 m³

LED SMD Driver ON/OFF incluso

Potenza	Angolo	Lumen	CCT	Finitura	Codice	€
26 W	110°	3150 lm	3000 K	Bianco	223186	295
		3450 lm	4000 K	Bianco	223193	295



4,430 Kg/0,0313 m³

LED SMD Driver ON/OFF incluso

Potenza	Angolo	Lumen	CCT	Finitura	Codice	€
32 W	110°	4050 lm	3000 K	Bianco	223209	395
		4200 lm	4000 K	Bianco	223216	395



6,600 Kg/0,0566 m³

LED SMD Driver ON/OFF incluso

Potenza	Angolo	Lumen	CCT	Finitura	Codice	€
46 W	110°	5950 lm	3000 K	Bianco	223223	545
		6250 lm	4000 K	Bianco	223230	545

KIT PENDANT



Necessario	Finitura	Codice	€
No	Bianco	223247	50



Ray **new**

Famiglia di lampade a plafone con base circolare, disponibile in tre diametri diversi (300 mm, 400 mm, 600 mm). Corpo luce in finitura bianco RAL 9016 o nero RAL 9005, ottica con diffusore in PMMA microprismatizzato con controllo dell'abbagliamento (UGR < 19, 22). Sorgente luminosa a LED integrati; disponibile in temperatura CRI ≥90; durata utile LED 50.000 L70B50; protezione IP44, classe isolamento II. La lampada è predisposta con un interruttore integrato per impostare due differenti tonalità nell'emissione di luce (temperatura di colore 3000 K oppure 4000 K). Driver incluso, integrato nel corpo illuminante, disponibile in versione non dimmerabile. Prodotto adatto per ambienti dove richiesta un'illuminazione flessibile, confortevole e uniforme, ad esempio negli UFFICI e negli ambienti interni del TERZIARIO o RESIDENZIALI.

IP44 Grado di protezione IP44.

Sorgente	LED SMD
Potenza	13W / 26W / 43W
Driver incluso	On/Off
Driver disponibili	No
CCT	3000 K / 4000 K
CRI	≥90
UGR	<19 / 22
Durata LED	50.000 h
Classe isolamento	II
IP	44
Materiale	Plastica
Garanzia	5 anni



Ray



LED SMD Driver TRIDONIC ON/OFF incluso - UGR <22

Potenza	Angolo	Lumen	CCT	Finitura	Codice	€
13W	80°	1900 - 2000 lm	3000 - 4000 K	Bianco	327570	185
				Nero	327563	185 new

1,620 Kg/0,0067 m³



LED SMD Driver TRIDONIC ON/OFF incluso - UGR <19

Potenza	Angolo	Lumen	CCT	Finitura	Codice	€
26W	80°	3850 - 4000 lm	3000 - 4000 K	Bianco	318264	270
				Nero	327600	270 new

2,160 Kg/0,0097 m³

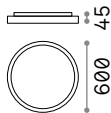

LED SMD Driver TRIDONIC ON/OFF incluso - UGR <19

Potenza	Angolo	Lumen	CCT	Finitura	Codice	€
43W	80°	6450 - 6750 lm	3000 - 4000 K	Bianco	327693	500
				Nero	327686	500 new

3,240 Kg/0,0251 m³



Light beam: WIDE

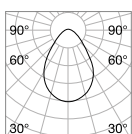

m	lx	Øm
1	760	1,50
2	190	3,00
3	84	4,40
4	48	5,90
5	30	7,40



CRI≥90 13W 80° 1900lm 3000K

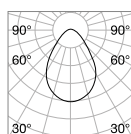

m	lx	Øm
1	1638	1,50
2	410	3,00
3	182	4,40
4	102	5,90
5	66	7,40



CRI≥90 26W 80° 3850lm 3000K

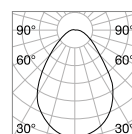

m	lx	Øm
1	2786	1,60
2	697	3,10
3	310	4,70
4	174	6,20
5	111	7,80



CRI≥90 43W 80° 6450lm 3000K



Universal Round new

Plafoniera diffusiva per installazione a soffitto o parete in interni, adatta per un'illuminazione generale e uniforme. Scocca in acciaio verniciato con finitura bianca, diffusore in materiale plastico. Sorgente luminosa integrata a LED, disponibile in 4 potenze differenti. Durata utile LED 17.500 h; protezione IP20, classe isolamento II.

Sorgente	LED SMD	Classe	II
Potenza	13,5W / 36W	isolamento	
Driver incluso	On/Off	IP	20
Driver disponibili	No	Materiale	Acciaio
CCT	3000 K / 4000 K		
CRI	≥80		
Durata LED	25.000 h		



0,420 Kg/0,0015 m³

LED SMD Driver ON/OFF incluso

Potenza	Angolo	Lumen	CCT	Finitura	Codice	€
13,5 W	110°	1250 lm	3000 K	Bianco	138596	30
			4000 K	Bianco	321776	30 new



0,580 Kg/0,0025 m³

LED SMD Driver ON/OFF incluso

Potenza	Angolo	Lumen	CCT	Finitura	Codice	€
19 W	110°	1950 lm	3000 K	Bianco	138602	35
			4000 K	Bianco	321752	35 new



0,850 Kg/0,0045 m³

LED SMD Driver ON/OFF incluso

Potenza	Angolo	Lumen	CCT	Finitura	Codice	€
25 W	110°	2600 lm	3000 K	Bianco	138619	50
			4000 K	Bianco	321738	50 new



1,390 Kg/0,0068 m³

LED SMD Driver ON/OFF incluso

Potenza	Angolo	Lumen	CCT	Finitura	Codice	€
36 W	110°	4300 lm	3000 K	Bianco	240367	85
			4000 K	Bianco	321684	85 new



Universal Square new

Plafoniera diffusiva per installazione a soffitto o parete in interni, adatta per un'illuminazione generale e uniforme. Scocca in acciaio verniciato con finitura bianca, diffusore in materiale plastico. Sorgente luminosa integrata a LED, disponibile in 4 potenze differenti. Durata utile LED 17.500 h; protezione IP20, classe isolamento II.

Sorgente	LED SMD	Classe	II
Potenza	13,5W / 36W	isolamento	
Driver incluso	On/Off	IP	20
Driver disponibili	No	Materiale	Acciaio
CCT	3000 K / 4000 K		
CRI	≥80		
Durata LED	25.000 h		



0,510 Kg/0,0015 m³

LED SMD Driver ON/OFF incluso

Potenza	Angolo	Lumen	CCT	Finitura	Codice	€
13,5 W	110°	1250 lm	3000 K	Bianco	138633	30
			4000 K	Bianco	321769	30 <small>new</small>



0,710 Kg/0,0025 m³

LED SMD Driver ON/OFF incluso

Potenza	Angolo	Lumen	CCT	Finitura	Codice	€
19 W	110°	1950 lm	3000 K	Bianco	138640	35
			4000 K	Bianco	321745	35 <small>new</small>



1,070 Kg/0,0045 m³

LED SMD Driver ON/OFF incluso

Potenza	Angolo	Lumen	CCT	Finitura	Codice	€
25 W	110°	2600 lm	3000 K	Bianco	138657	50
			4000 K	Bianco	321707	50 <small>new</small>



2,000 Kg/0,0068 m³

LED SMD Driver ON/OFF incluso

Potenza	Angolo	Lumen	CCT	Finitura	Codice	€
36 W	110°	4300 lm	3000 K	Bianco	240374	85
			4000 K	Bianco	321660	85 <small>new</small>



Clara

Base in metallo verniciato.
Diffusore in policarbonato opale satinato.

LED Sorgente luminosa LED 3000/4000 K,
30.000 h di durata.

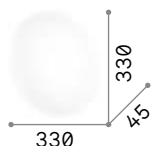

■ ■ □ IP20

0,500 Kg / 0,0082 m³
LED 17W / 1700/1750 lm

€ 25

300436 Bianco 3000K
306438 Bianco 4000K

■ ■ □ IP20

0,670 Kg / 0,0141 m³
LED 18W / 2000/2050 lm

€ 35

300443 Bianco 3000K
306445 Bianco 4000K



Flat

Montatura in metallo smaltato
bianco opaco. Diffusore in lastra di
acrilico satinato trasparente.

LED Lampadine LED GX53 9W 3000 K
includ. Cod. **123936**

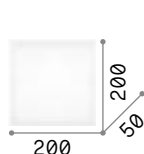
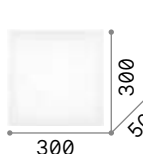
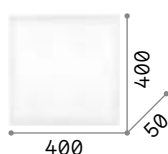

■ ■ □ IP20

■ ■ □ IP20

■ ■ □ IP20

2,480 Kg / 0,0263 m³
GX53 max 4 x 15W

€ 228

134901 Bianco

1,620 Kg / 0,0159 m³
GX53 max 4 x 15W

€ 136

134895 Bianco

0,700 Kg / 0,0088 m³
GX53 max 1 x 15W

€ 90

134888 Bianco

3000 K
910 lm

123936 € 5,50

3000 K
910 lm

123936 € 5,50

3000 K
910 lm

123936 € 5,50



Celine

Base in metallo smaltato. Diffusore in vetro trasparente sabbato. Viti ferma vetro in metallo cromato.

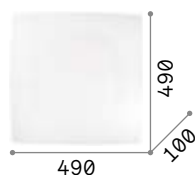

IP20

2,540 Kg / 0,0467 m³
E27 max 4x60W

€ 105

044293 Bianco

101286 3000 K
340 lm

101286 € 2,60

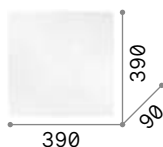

IP20

1,740 Kg / 0,0265 m³
E27 max 3x60W

€ 64

044286 Bianco

101286 3000 K
340 lm

101286 € 2,60

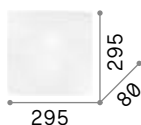

IP20

1,120 Kg / 0,0149 m³
E27 max 2x60W

€ 49

044279 Bianco

101286 3000 K
340 lm

101286 € 2,60

Ocean

Diffusore composto da due lastre di vetro: sotto con bordo a specchio e smerigliato al centro, sopra con decorazione serigrafata e applicazioni di bottoni in vetro.

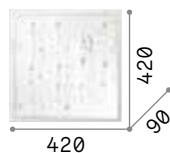

IP20

2,930 Kg / 0,0281 m³
E27 max 3x60W

€ 110

081441 Trasparen.
091013 Color

101286 3000 K
340 lm

101286 € 2,60

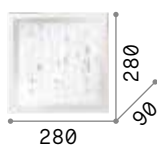

IP20

1,930 Kg / 0,0160 m³
E27 max 2x60W

€ 75

081434 Trasparen.
091006 Color

101286 3000 K
340 lm

101286 € 2,60



091013











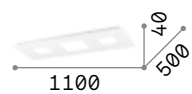
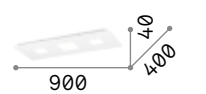

0801441



Relax

Montatura in metallo rifinito con vernice opaca bianca. Diffusori in policarbonato opale. Doppia emissione luminosa: principale e laterale. Sorgente LED sostituibile. Alimentatore dimmerabile integrato.

LED Sorgente luminosa LED 3000 K, 17.500 h di durata.









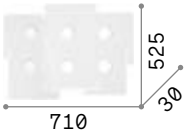
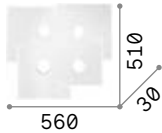
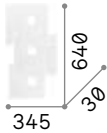

	
    	    
8,190 Kg / 0,0740 m³ LED 78W / 5250 lm	5,760 Kg / 0,0486 m³ LED 58W / 4600 lm
€ 450	€ 400
255941 Bianco	255934 Bianco



Totem

Base in metallo sagomato a laser e verniciato bianco opaco. Sorgenti luminose a LED sostituibili.

LED Lampadine LED GX53 9W 3000 K incluse. Cod. **123936**

		
710 525 ∅	560 510 ∅	345 640 ∅
 IP20  INCLUSA	 IP20  INCLUSA	 IP20  INCLUSA
5,320 Kg / 0,0470 m³ GX53 max 6 x 15W	3,890 Kg / 0,0322 m³ GX53 max 4 x 15W	2,960 Kg / 0,0227 m³ GX53 max 3 x 15W
€ 280	€ 240	€ 200
215785 Bianco	215778 Bianco	215761 Bianco
 3000 K 910 lm	 3000 K 910 lm	 3000 K 910 lm
123936 € 5,50	123936 € 5,50	123936 € 5,50



Gemini **new**

Montatura in metallo verniciato a polveri o placcato. Diffusore in policarbonato opale. Disponibile nelle finiture bianco, nero o ottone spazzolato. Controllo: On-Off oppure dimmerabile DALI/Push.

LED Sorgente luminosa LED 3000 K, 30.000 h di durata.

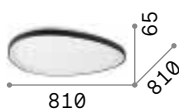

4,800 Kg / 0,0919 m³
LED 41W / 5600 lm

€ 390 On-Off / 480 Dalì

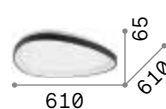

3,200 Kg / 0,0507 m³
LED 27W / 3650 lm

€ 300 On-Off / 380 Dalì

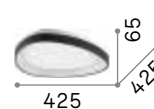

1,900 Kg / 0,0271 m³
LED 23W / 3100 lm

€ 220

328072	Bianco	On-Off new	328041	Bianco	On-Off new	328010	Bianco	new
328973	Bianco	Dalì/ Push new	328942	Bianco	Dalì/ Push new	328027	Nero	new
328089	Nero	On-Off new	328058	Nero	On-Off new	328034	Ottone	new
328980	Nero	Dalì/ Push new	328959	Nero	Dalì/ Push new			
328096	Ottone	On-Off new	328065	Ottone	On-Off new			
329260	Ottone	Dalì/ Push new	328966	Ottone	Dalì/ Push new			





Gingle

Base e corpo luce in metallo verniciato a polveri. Sorgente luminosa a led integrati con emissione di luce riflessa.

LED Sorgente luminosa LED 3000 K, 30.000 h di durata.

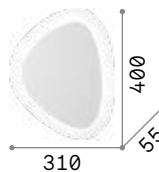

■ ■ □ IP20

1,540 Kg / 0,0233 m³
LED 35W / 2150 lm

€ 315

196220 Bianco

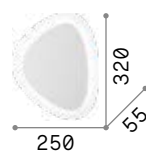

■ ■ □ IP20

1,000 Kg / 0,0139 m³
LED 26W / 1700 lm

€ 225

196206 Bianco

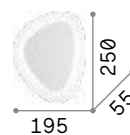

■ ■ □ IP20

0,730 Kg / 0,0153 m³
LED 19W / 1300 lm

€ 165

196190 Bianco



Geko

Montatura in metallo smaltato bianco. Diffusore con vetro trasparente serigrafato in bianco. Elemento centrale fissa vetro in metallo cromato.

3,820 Kg / 0,0385 m³ E27 max 4 x 60W	2,000 Kg / 0,0203 m³ E27 max 3 x 60W	1,200 Kg / 0,0130 m³ E27 max 2 x 60W
€ 180	€ 120	€ 85
116112 Bianco	018508 Bianco	010861 Bianco
3000 K 340 lm	3000 K 340 lm	3000 K 340 lm
101286 € 2,60	101286 € 2,60	101286 € 2,60

Glory

Montatura in metallo con finitura nickel satinato. Diffusore in vetro bianco soffiato e acidato.

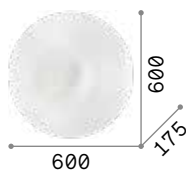

IP20

4,810 Kg / 0,1789 m³
E27 max 5 x 60W

€ 350

019765 Bianco

3000 K
340 lm
101286 € 2,60

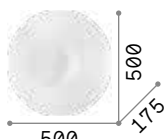

IP20

3,410 Kg / 0,0744 m³
E27 max 3 x 60W

€ 220

019758 Bianco

3000 K
340 lm
101286 € 2,60

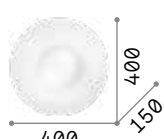

IP20

2,100 Kg / 0,0700 m³
E27 max 2 x 60W

€ 195

101132 Bianco

3000 K
340 lm
101286 € 2,60



P. 153

Level

Base in metallo verniciato a polveri. Diffusore in vetro soffiato bianco acidato con sistema di fissaggio senza viti. Sorgente a led integrato facilmente sostituibile.

LED Sorgente luminosa LED 3000 K, 17.500 h di durata.

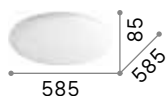

IP20

5,200 Kg / 0,0908 m³
LED 37,5W / 3300 lm

€ 290

261188 Bianco

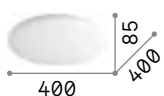

IP20

2,100 Kg / 0,0368 m³
LED 22,5W / 2100 lm

€ 180

261164 Bianco





Smarties

Montatura in metallo verniciato bianco. Diffusore in vetro bianco soffiato.

4,690 Kg / 0,1480 m ³ E27 max 3 x 60W	3,070 Kg / 0,1009 m ³ E27 max 3 x 60W	2,810 Kg / 0,0599 m ³ E27 max 2 x 60W	1,440 Kg / 0,0454 m ³ E27 max 1 x 60W
€ 280	€ 195	€ 170	€ 115
032023 Bianco	032030 Bianco	032047 Bianco	009223 Bianco
3000 K 340 lm	3000 K 340 lm	3000 K 340 lm	3000 K 340 lm
101286 € 2,60	101286 € 2,60	101286 € 2,60	101286 € 2,60



P. 152



P. 397



P. 485



Arizona

Montatura in metallo rifinito in ottone satinato. Diffusore in vetro bianco soffiato, acidato e con rigature decorative in rilievo.



LED Lampadine LED GX53 9W 3000 K incluse. Cod. **123936**

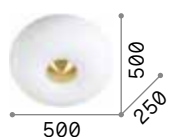

IP20 INCLUSA

7,680 Kg / 0,1299 m³
GX53 max 5 x 15W

€ 505

214511 Bianco

3000 K
910 lm

123936 € 5,50

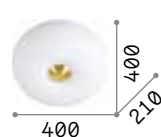

IP20 INCLUSA

3,050 Kg / 0,0744 m³
GX53 max 3 x 15W

€ 330

214504 Bianco

3000 K
910 lm

123936 € 5,50

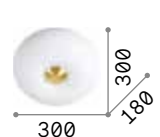

IP20 INCLUSA

2,960 Kg / 0,0452 m³
GX53 max 2 x 15W

€ 225

214498 Bianco

3000 K
910 lm

123936 € 5,50



P. 154



Atrium **new**

Montatura in metallo verniciato bianco opaco. Diffusore in vetro bianco acidato con sistema di fissaggio ad incastro.

LED Sorgente luminosa LED 3000 K, 20.000 h di durata.

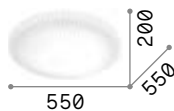

■ ■ □ IP20

4,8 Kg / 0,1113 m³
LED 34W / 3600 lm

€ 220

265841 Bianco **new**

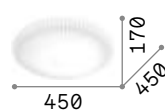

■ ■ □ IP20

3,700 Kg / 0,0675 m³
LED 21W / 2250 lm

€ 160

265827 Bianco **new**

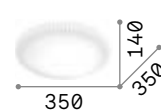

■ ■ □ IP20

2,300 Kg / 0,0425 m³
LED 12W / 1200 lm

€ 115

265803 Bianco **new**



Candy

Montatura in metallo con finitura nickel satinato. Diffusore in vetro bianco soffiato e acidato.

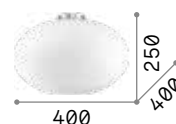

2,500 Kg / 0,0799 m³
E27 max 1x60W

€ 197

086781 Bianco

3000 K
900 lm

123899 € 6,00



P. 156



P. 486



Cotton **new**

Base in metallo rifinito con vernice a polveri di colore bianco. Diffusore in vetro soffiato bianco acidato con fissaggio a vite.



Lampadine LED G9 4W 3000 K incluse nel modello **297750**. Cod. **209043**

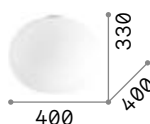

■ □ IP20

2,400 Kg / 0,0810 m³
E27 max 1x42W

€ 180

327891 Bianco **new** 297743 Bianco **new** 297750 Bianco **new**

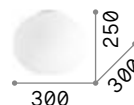

■ □ IP20

0,810 Kg / 0,0369 m³
E27 max 1x42W

€ 125



■ □ IP20

0,500 Kg / 0,0049 m³
G9 max 1x4W

€ 50



P. 157



P. 485

3000 K
900 lm

123899 € 6,00

3000 K
900 lm

123899 € 6,00

3000 K
510 lm

305486 € 6,00



Mapa Bianco

Base e sistema di fissaggio in metallo bianco. Diffusore a sfera in vetro bianco soffiato e acidato.



IP20

2,590 Kg / 0,1290 m³
E27 max 1x60W

€ 188

059839 Bianco

3000 K
910 lm

119571 € 6,00



P. 164



P. 396



P. 487



Carta **new**

Montatura in metallo verniciato bianco opaco. Diffusore in policarbonato con rivestimento ad effetto carta.

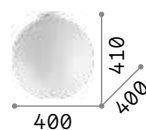

1,700 Kg / 0,0813 m³
E27 max 1x25W

€ 225

317120 Bianco **new**

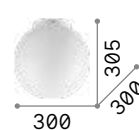

1,150 Kg / 0,0370 m³
E27 max 1x25W

€ 110

317113 Bianco **new**



P. 166 P. 397 P. 484 P. 545



119571 € 6,00



101279 € 2,60

Ovalino

Montatura in metallo smaltato.
Diffusore con elementi in lastra di vetro curvata e acidata.

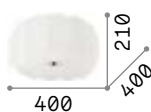
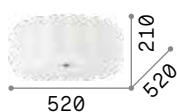

IP20

IP20

7,700 Kg / 0,1448 m³
E27 max 8 x 60W

5,100 Kg / 0,1202 m³
E27 max 5 x 60W

€ 320

€ 250

094014 Bianco

093963 Bianco

3000 K
900 lm
123899 € 6,00

3000 K
900 lm
123899 € 6,00

P. 155 P. 394



Cloud

Montatura ed elementi decorativi in metallo rifinito con vernice opaca.
Diffusori in acrilico opale. Emissione luce indiretta. Colore: bianco.

LED Sorgente luminosa LED 3000 K,
17.500 h di durata.

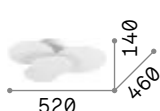
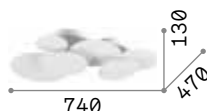

IP20

IP20

4,700 Kg / 0,0792 m³
LED 46W / 4000 lm

3,200 Kg / 0,0647 m³
LED 33W / 2900 lm

€ 310

€ 210

285207 Bianco

263519 Bianco





Corolla **new**

Montatura in metallo verniciato bianco opaco. Diffusore in policarbonato opale satinato.

LED Sorgente luminosa LED 3000 K, 50.000 h di durata.

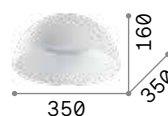

■ □ IP20

2,450 Kg / 0,0274 m³
LED 24W / 2800 lm

€ 175

297149 Bianco **new**

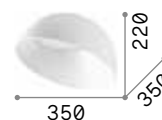

■ □ IP20

2,450 Kg / 0,0304 m³
LED 24W / 2800 lm

€ 175

297101 Bianco **new**



Ziggy new

Corpo luce in metallo verniciato a polveri. Pareti interne diffondenti in policarbonato opale satinato.

LED Sorgente luminosa LED 3000 K, 50.000 h di durata.

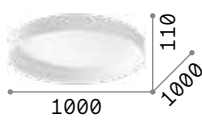
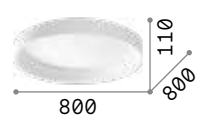
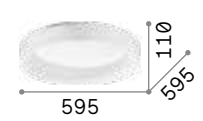
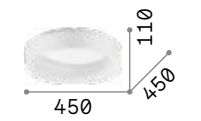
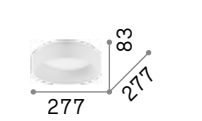

				
1000	800	595	450	277
110	80	59.5	45	27.7
■ □ IP20	■ □ IP20	■ □ IP20	■ □ IP20	■ □ IP20
10,350 Kg / 0,1460 m ³ LED 90W / 5620 lm	6,660 Kg / 0,0953 m ³ LED 62W / 4320 lm	4,000 Kg / 0,0553 m ³ LED 42W / 5500 lm	2,500 Kg / 0,0324 m ³ LED 30W / 3800 lm	1,350 Kg / 0,0096 m ³ LED 22W / 2300 lm
€ 700	€ 430	€ 300	€ 200	€ 140
321592 Bianco <small>new</small> 317915 Nero	317908 Bianco <small>new</small> 321615 Nero	293790 Bianco <small>new</small> 307213 Nero	293783 Bianco 307206 Nero	293776 Bianco 293769 Nero



Planet **new**

Base e disco riflettente centrale in metallo verniciato opaco. Diffusore in policarbonato opale satinato.
Finiture: bianco, nero.

LED Sorgente luminosa LED 3000 K,
30.000 h di durata.

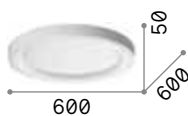

2,950 Kg / 0,0365 m³
LED 33W / 3050 lm

€ 145

312378 **Bianco** **new**
312361 **Nero** **new**

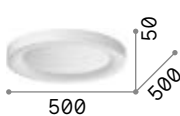

2,150 Kg / 0,0257 m³
LED 28W / 2650 lm

€ 115

312354 **Bianco** **new**
328157 **Nero** **new**

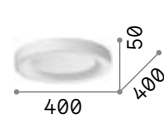

1,350 Kg / 0,0168 m³
LED 23W / 2100 lm

€ 95

312347 **Bianco** **new**
312330 **Nero** **new**

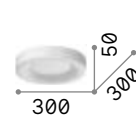

0,820 Kg / 0,0097 m³
LED 17W / 1600 lm

€ 75

312323 **Bianco** **new**
328140 **Nero** **new**



P. 126 P. 536

Mix Up

Montatura e paralumi intercambiabili in metallo verniciato a polveri. Finiture: bianco oppure nero.

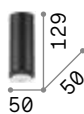

IP20

0,270 Kg / 0,005 m³
E27 max 1x60W

€ 35

292847 ■ Bianco
292830 ■ Nero

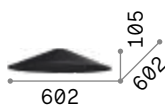

2,000 Kg / 0,0676 m³

€ 85

288437 ■ Bianco
288420 ■ Nero



1,100 Kg / 0,0446 m³

€ 55

307404 ■ Bianco
288475 ■ Nero

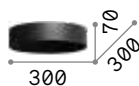

0,800 Kg / 0,0147 m³

€ 40

307411 ■ Bianco
288444 ■ Nero

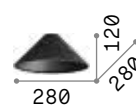

0,500 Kg / 0,0174 m³

€ 35

307428 ■ Bianco
288451 ■ Nero

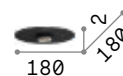

0,340 Kg / 0,0008 m³

€ 20

307435 ■ Bianco
288482 ■ Nero

3000 K
900 lm

123899 € 6,00



P. 196 P. 446 P. 504 P. 558

Set Up

Montature in metallo verniciato a polveri. Paralumi in pvc ignifugo rivestito di tessuto. Colori paralumi: beige, tortora, bianco o nero.



260457

304625

270012

260464

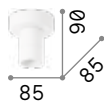

IP20

0,300 Kg / 0,0010 m³
E27 max 1x60W

€ 35

277288 Bianco

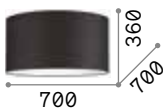

1,260 Kg / 0,2131 m³

€ 116

260471 Bianco
304632 Tortora
270029 Nero
260488 Beige

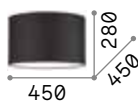

0,047 Kg / 0,0210 m³

€ 85

260457 Bianco
304625 Tortora
270012 Nero
260464 Beige



0,023 Kg / 0,0238 m³

€ 55

260433 Bianco
304618 Tortora
270005 Nero
260440 Beige

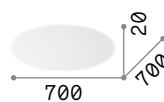

0,700 Kg / 0,0259 m³

€ 50

270050 Trasparen.

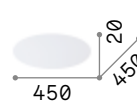

0,280 Kg / 0,0108 m³

€ 30

270043 Trasparen.

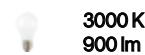

123899 € 6,00



122205

122212

090863

Woody

Montatura in metallo cromato.
Diffusore in PVC o in tessuto,
chiuso sul fondo da vetro
trasparente acidato.



6,000 Kg / 0,1352 m³
E27 max 5 x 60W

€ 250

122205 ■ Bianco
122212 ■ Nero
090863 ■ Legno

3000 K
900 lm

123899 € 6,00



3,800 Kg / 0,0908 m³
E27 max 4 x 60W

€ 185

103266 ■ Bianco
103273 ■ Nero
090900 ■ Legno

3000 K
900 lm

123899 € 6,00

Wheel

Base e telaio in metallo smaltato.
Paralume in lamina di PVC ignifugo,
rivestita di tessuto.

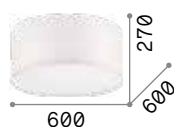

3,890 Kg / 0,1270 m³
E27 max 5 x 60W

€ 255

036021 Bianco



123899 € 6,00

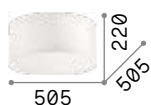

2,280 Kg / 0,0758 m³
E27 max 3 x 60W

€ 130

036014 Bianco

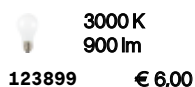

123899 € 6,00



P. 194



Ritz

Base in metallo smaltato. Paralume
e pannello diffusore inferiore in
lamina di PVC rivestita di tessuto.

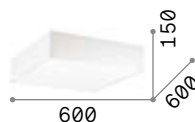

1,710 Kg / 0,0968 m³
E27 max 4 x 42W

€ 250

152912 Bianco



123899 € 6,00

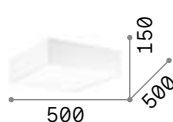

1,480 Kg / 0,0700 m³
E27 max 4 x 42W

€ 200

152899 Bianco

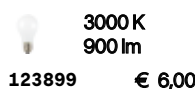

123899 € 6,00

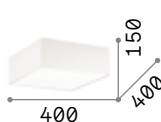

1,110 Kg / 0,0444 m³
E27 max 4 x 42W

€ 155

152875 Bianco

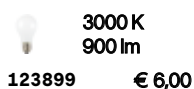

123899 € 6,00



Simply

Diffusore in vetro trasparente sabbato. Ganci ferma vetro in metallo cromato con sistema di bloccaggio a molla.

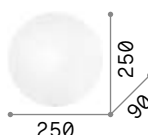
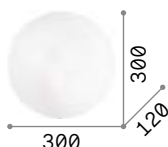
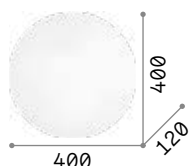
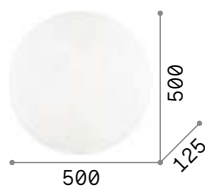

3,190 Kg / 0,0511 m³
E27 max 4 x 60W

€ 85

007991 Bianco

1,670 Kg / 0,0284 m³
E27 max 3 x 60W

€ 54

007984 Bianco

1,010 Kg / 0,0107 m³
E27 max 2 x 60W

€ 37

007977 Bianco

0,670 Kg / 0,0060 m³
E27 max 1 x 60W

€ 28

007960 Bianco

3000 K
340 lm
101286 € 2,60

3000 K
340 lm
101286 € 2,60

3000 K
340 lm
101286 € 2,60

3000 K
340 lm
101286 € 2,60

Lana

Diffusore in vetro trasparente con decorazioni serigrafate all'interno e sabbato all'esterno. Ganci ferma vetro in metallo cromato.

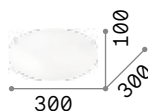
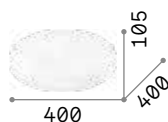

1,500 Kg / 0,0279 m³
E27 max 3 x 60W

€ 68

068145 Bianco

0,800 Kg / 0,0168 m³
E27 max 2 x 60W

€ 46

068138 Bianco

3000 K
340 lm
101286 € 2,60

3000 K
340 lm
101286 € 2,60



P. 151





Shell

Diffusore di vetro trasparente lavorato in piastra e decorato all'interno con graniglia. Blocca vetro con dettaglio in metallo. Disponibile trasparente con dettaglio cromato o ambra con dettaglio ottonato.



008622



140193

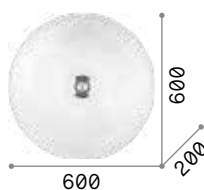

8,850 Kg / 0,0943 m³
E27 max 6 x 60W

€ 290

008622 Trasparen.
140193 Ambra

3000 K
430 lm

101279 € 2,60

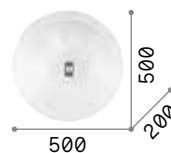

6,150 Kg / 0,0647 m³
E27 max 4 x 60W

€ 210

008615 Trasparen.
140186 Ambra

3000 K
430 lm

101279 € 2,60

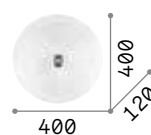

3,940 Kg / 0,0381 m³
E27 max 3 x 60W

€ 140

008608 Trasparen.
140179 Ambra

3000 K
430 lm

101279 € 2,60



Gemma

Base in plastica con varie finiture.
Diffusore in policarbonato bianco opaco. Sistema di fissaggio rapido.



Sorgente luminosa LED 3000 K,
20.000 h di durata.



252612



252629

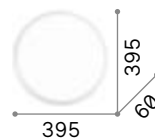

0,760 Kg / 0,0275 m³
LED 24W / 2880 lm

€ 40

252612 ■ Bianco
252629 ■ Nero

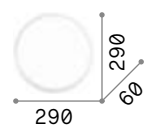

0,430 Kg / 0,0164 m³
LED 12W / 1440 lm

€ 30

252599 ■ Bianco
252605 ■ Nero



Aura

Corpoluce e diffusore in materiale plastico opaco. Apparecchio per installazione in superficie o a incasso. Finiture: bianco oppure nero.

LED Sorgente luminosa LED
3000/4000 K, 30.000 h di durata.

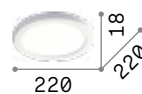

0,350 Kg / 0,0018 m³
LED 20W / 2050/2100 lm
€ 35

290799 ■ Bianco 3000K
306346 ■ Bianco 4000K
290775 ■ Nero 3000K
306360 ■ Nero 4000K

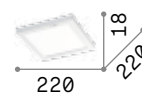

0,400 Kg / 0,0018 m³
LED 20W / 2200/2250 lm
€ 40

290836 ■ Bianco 3000K
306384 ■ Bianco 4000K
290812 ■ Nero 3000K
306407 ■ Nero 4000K



Look

Base di fissaggio in alluminio tornito. Diffusore cilindrico in metallo verniciato a polveri bianco o nero oppure in ottone satinato.

LED Lampadine LED GU10 7W 3000 K incluse. Cod. **123943**

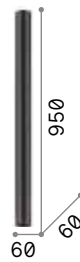

3,070 Kg / 0,0061 m³
GU10 max 1x28W

€ 86

259260 ■ Bianco
259277 ■ Nero

3000 K
540 lm

123943 € 3,50



1,380 Kg / 0,0037 m³
GU10 max 1x28W

€ 60

233352 ■ Bianco
233321 ■ Nero

3000 K
540 lm

123943 € 3,50

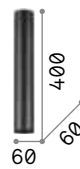

0,740 Kg / 0,0025 m³
GU10 max 1x28W

€ 48

233215 ■ Bianco
233192 ■ Nero

3000 K
540 lm

123943 € 3,50

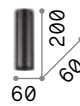

0,400 Kg / 0,0013 m³
GU10 max 1x28W

€ 38

233079 ■ Bianco
233062 ■ Nero
285214 ■ Ottone

3000 K
540 lm

123943 € 3,50



P. 074 P. 393 P. 534 P. 708



Sky

Corpo luce diffusore in metallo verniciato a polveri con finitura bianca o nera. Sistema di fissaggio senza viti a vista.

LED Lampadine LED GU10 7W 3000 K incluse. Cod. **123943**



1,940 Kg / 0,0047 m³
GU10 max 1x28W

€ 70

234007 **Bianco**
233970 **Nero**

3000 K
540 lm
123943 € 3,50



1,090 Kg / 0,0027 m³
GU10 max 1x28W

€ 65

233833 **Bianco**
233826 **Nero**

3000 K
540 lm
123943 € 3,50

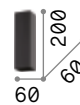

0,600 Kg / 0,0016 m³
GU10 max 1x28W

€ 47

233772 **Bianco**
233765 **Nero**

3000 K
540 lm
123943 € 3,50



Nitro new

Corpo luce in alluminio verniciato bianco o nero opachi. Interno rifinito con mascherina in plastica. Sorgente luminosa a led integrato con lente.

LED Sorgente luminosa LED 3000 K, 50.000 h di durata.

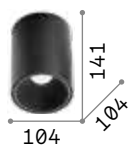

IP20

0,860 Kg / 0,0018 m³
LED 25W / 2350 lm

€ 115

319568 **Bianco** new 205977 **Bianco**
322711 **Nero** new 205984 **Nero**

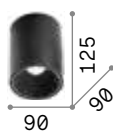

IP20

0,910 Kg / 0,0030 m³
LED 15W / 1350 lm

€ 90

205991 **Bianco**
206004 **Nero**

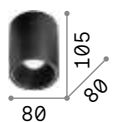

IP20

0,390 Kg / 0,0013 m³
LED 10W / 1100 lm

€ 65

319575 **Bianco** new 206011 **Bianco**
319582 **Nero** new 206028 **Nero**

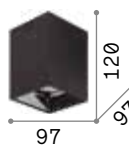

IP20

0,700 Kg / 0,0016 m³
LED 25W / 2350 lm

€ 115

206035 **Bianco**
206042 **Nero**

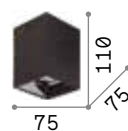

IP20

0,400 Kg / 0,0013 m³
LED 15W / 1350 lm

€ 90

206035 **Bianco**
206042 **Nero**



IP20

0,230 Kg / 0,0005 m³
LED 10W / 1100 lm

€ 65

206035 **Bianco**
206042 **Nero**



Kubiko **new**

Corpo luce in alluminio verniciato a polveri. Diffusore in policarbonato opale lucido. Sistema di fissaggio magnetico. Finiture: bianco, nero.

LED

Sorgente luminosa LED 3000 K,
30.000 h di durata.

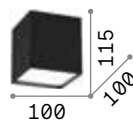

IP20

0,660 Kg / 0,0020 m³
LED 10W / 1100 lm

€ 80

303321 **Bianco** **new**
303314 **Nero** **new**



303321



303314



Mood

Corpo luce in metallo disponibile con sezione quadra o tonda. Nero all'interno e bianco o nero all'esterno. Diffusore interno orientabile.

LED Lampadine GU10 7W e GU10 10W 3000 K incluse.



140841

243924

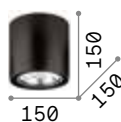

1,210 Kg / 0,0061 m³
GU10 max 1x 50W

€ 97

140872 **Bianco**
243450 **Nero**

3000 K
800 lm

189031 € 15,00

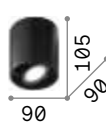

0,400 Kg / 0,0022 m³
GU10 max 1x 28W

€ 64

140841 **Bianco**
243924 **Nero**

3000 K
540 lm

123943 € 3,50

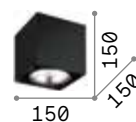

1,420 Kg / 0,0068 m³
GU10 max 1x 50W

€ 97

140933 **Bianco**
243931 **Nero**

3000 K
800 lm

189031 € 15,00

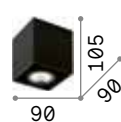

0,460 Kg / 0,0023 m³
GU10 max 1x 28W

€ 64

140902 **Bianco**
243948 **Nero**

3000 K
540 lm

123943 € 3,50



Dot ^{new}

Base e corpo luce e ghiera in alluminio verniciato a polveri. Diffusore in acrilico trasparente satinato. Apparecchio per installazione in superficie. Finiture: bianco oppure nero.



LED Sorgente luminosa LED 3000/4000 K, 50.000 h di durata.



319797



319803

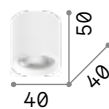

IP20

0,600 Kg / 0,0004 m³
LED 4W / 320/370 lm

€ 45

299419 ■ Bianco 3000K
306513 ■ Bianco 4000K
299402 ■ Nero 3000K
306520 ■ Nero 4000K

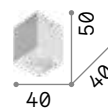

IP20

0,100 Kg / 0,0004 m³
LED 4W / 370 lm

€ 67

319797 ■ Bianco 3000K ^{new}
319803 ■ Nero 3000K ^{new}



Spike **new**

Corpo luce e base in alluminio tornito verniciato a polveri o placcato. Sorgente luminosa a led sostituibile. Colori: bianco, cromo, nickel, nero, ottone satinato oppure rame brunito.

LED Lampadine LED GX53 9W 3000 K incluse. Cod. **123936**



285238



310893



328799



328805

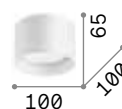

IP20

0,240 Kg / 0,0017 m³
GX53 max 1x15W

€ 80

- 277417 Bianco
- 310886 Cromo **new**
- 314303 Nickel **new**
- 278704 Nero **new**
- 285238 Ottone **new**
- 310893 Rame **new**

3000 K
910 lm

123936

€ 5,50

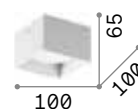

IP20

0,220 Kg / 0,0014 m³
GX53 max 1x15W

€ 85

- 317489 Bianco **new**
- 328799 Cromo **new**
- 328805 Nickel **new**
- 317496 Nero **new**
- 317502 Ottone **new**
- 328812 Rame **new**

3000 K
910 lm

123936

€ 5,50

Oak

Corpo luce in gesso o cemento.
Elemento portalampada centrale orientabile in metallo verniciato.

 Articolo adatto alla pittura e verniciatura.

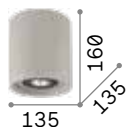

■ □ IP20

1,730 Kg / 0,0082 m³
GU10 max 1x 35W

€ 76

150420 Bianco
150437 Cemento

 3000 K
410 lm

108292 € 3,00

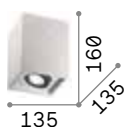

■ □ IP20

2,210 Kg / 0,0078 m³
GU10 max 1x 35W

€ 76

150468 Bianco
150475 Cemento

 3000 K
410 lm

108292 € 3,00



P. 076



150420

150475

Tower

Base di fissaggio in materiale
plastico con sistema a baionetta.
Corpo luce interamente in gesso.
Monta lampadine GU10 sostituibili.

 Articolo adatto alla pittura e verniciatura.



■ □ IP20

0,430 Kg / 0,0023 m³
GU10 max 1x 35W

€ 39

155869 Bianco

 3000 K
410 lm

108292 € 3,00



■ □ IP20

0,620 Kg / 0,0023 m³
GU10 max 1x 35W

€ 39

155791 Bianco

 3000 K
410 lm

108292 € 3,00



155869

155791



Lika

Famiglia di moduli LED rettangolari in alluminio pressofuso, verniciato nero o bianco con riflettore in policarbonato. Moduli disponibili con cinque lenti. Appositamente disegnato per evitare abbagliamenti ($UGR < 16$), trova la sua migliore collocazione all'interno di UFFICI e spazi COMMERCIALI.

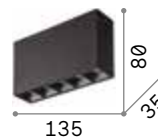

IP20

0,370 Kg / 0,0011 m³
LED 12,5W / 1200 lm

€ 90

248530 ■ Bianco
244884 ■ Nero

LED Sorgente luminosa LED 3000 K,
50.000 h di durata.



P. 786



Dynamite

Montatura in metallo rifinito con vernice a polveri o placcato e spazzolato. Diffusori orientabili.

LED Lampadine LED GU10 7W 3000 K incluse. Cod. **123943**

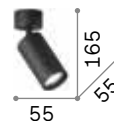

0,430 Kg / 0,0037 m³
GU10 max 1x28W

€ 98

231495 ■ Bianco
231471 ■ Nero
244662 ■ Ottone

3000 K
540 lm

123943 € 3,50



P. 090

Play

Base, snodo e corpo luce orientabile in alluminio pressofuso verniciato a polveri. Diffusore in acrilico trasparente zigrinato. Disponibile nelle finiture nero oppure bianco con cover posteriore e ghiera frontale interni neri.

LED Sorgente luminosa LED 3000 K, 30.000 h di durata.

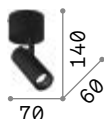

IP20

0,240 Kg / 0,0010 m³
LED 7W / 520 lm

€ 70

258287 Bianco
268101 Nero



P. 780



Toby

Montatura in alluminio pressofuso verniciato a polveri. Diffusori orientabili in rotazione e inclinazione. Colori: bianco o nero.

LED Lampadine LED GU10 7W 3000 K incluse. Cod. 123943

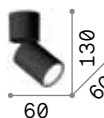

IP20

0,220 Kg / 0,0008 m³
GU10 max 1x 35W

€ 50

271538 Bianco
271545 Nero

3000 K
540 lm

123943 € 3,50





Petit **new**

Corpo luce in metallo placcato o verniciato opaco. Sistema di fissaggio senza viti a vista. Disponibile con finitura bianca, ottone e nero.

LED Lampadine LED E27 8W Globo D95 3000 K incluse nei modelli: **232966**, **232980** e **233031**. Cod. **101330**



232966



232980



233031

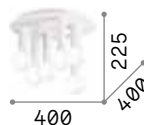

3,000 Kg / 0,0499 m³
E27 max 6 x 42W

€ 130

327983 **Bianco** **new**
327976 **Nero** **new**
301532 **Ottone** **new**

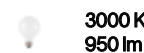

3000 K
950 lm
101330 € 7,50



1,570 Kg / 0,0294 m³
E27 max 3 x 42W

€ 80

327969 **Bianco** **new**
327952 **Nero** **new**
301525 **Ottone** **new**

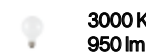

3000 K
950 lm
101330 € 7,50



0,790 Kg / 0,0071 m³
E27 max 1 x 42W

€ 40

232966 **Bianco** **new**
232980 **Nero** **new**
233031 **Ottone** **new**

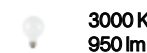

3000 K
950 lm
101330 € 7,50



Winery

Corpo luce con portalampane incorporato interamente in ceramica con finitura in smalto lucido bianco o nero.



155227



155142



P. 428

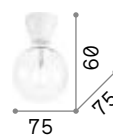

IP20

0,290 Kg / 0,0004 m³
E27 max 1x 60W

€ 24

155227 ■ Bianco
155142 ■ Nero

3000 K
1120 lm

101323 € 7,00

Mouse

Base, montatura e diffusori in metallo rifinito con vernice opaca e dettagli in cromo. Diffusori orientabili. Disponibile nelle finiture bianco o nero.



■ □ ⊕ IP20

1,900 Kg / 0,0157 m³
GU10 max 4 x 50W

€ 260

073583 ■ Bianco
156712 ■ Nero

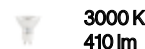

108292 € 3,00



P. 422 P. 704



073583

156712

Spot

Base, montatura e diffusori in metallo rifinito con vernice opaca e dettagli in cromo. Diffusori orientabili. Disponibile nelle finiture bianco o nero.



■ □ ⊕ IP20

1,320 Kg / 0,0139 m³
GU10 max 4 x 50W

€ 100

156774 ■ Bianco
156781 ■ Nero

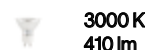

108292 € 3,00



P. 422 P. 704



156774

156781



Oby

Montatura in metallo verniciato bianco opaco, con snodi cromati. Corpo luce orientabile con diffusore in materiale plastico bianco.

LED Sorgente luminosa LED 3000 K, 20.000 h di durata.



■ □ ⊕ IP20

1,210 Kg / 0,0058 m³
LED 24W / 2800 lm

€ 260

196718 Bianco

■ □ ⊕ IP20

0,870 Kg / 0,0038 m³
LED 18W / 2100 lm

€ 185

196701 Bianco





Rudy new

Montatura in alluminio pressofuso verniciato a polveri bianco o nero. Diffusori orientabili in rotazione e inclinazione.

LED Lampadine LED GU10 7W 3000 K incluse. Cod. **123943**



229089 229065

294827 294810

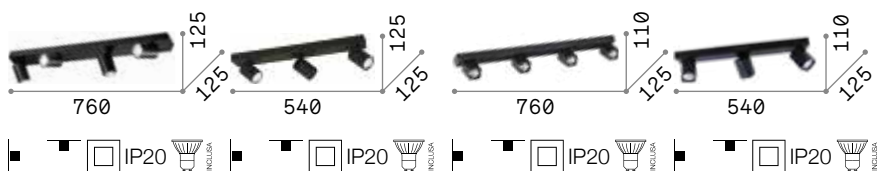

1,230 Kg / 0,0057 m³
GU10 max 4 x 35W
€ 185

1,080 Kg / 0,0041 m³
GU10 max 3 x 35W
€ 127

1,230 Kg / 0,0057 m³
GU10 max 3 x 35W
€ 195

1,080 Kg / 0,0041 m³
GU10 max 3 x 35W
€ 150

229089 **Bianco**
229072 **Nero**

229065 **Bianco**
229058 **Nero**

294827 **Bianco** new
321523 **Nero** new

294810 **Bianco** new
321516 **Nero** new

3000 K
540 lm
123943 € 3,50

3000 K
540 lm
123943 € 3,50

3000 K
540 lm
123943 € 3,50

3000 K
540 lm
123943 € 3,50





Profilo new

Base con fissaggio ad incasso e diffusore orientabile in metallo verniciato a polveri. Finiture: bianco, nero.

LED Lampadine LED GU10 7W 3000 K incluse. Cod. **123943**



314716



314723

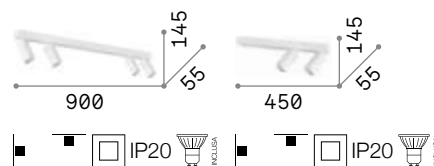

1,900 Kg / 0,0151 m³
GU10 max 4 x 28W

€ 155

328188 ■ Bianco new
328195 ■ Nero new

 3000 K
540 lm

123943 € 3,50

0,940 Kg / 0,0078 m³
GU10 max 2 x 28W

€ 75

314716 ■ Bianco new
314723 ■ Nero new

 3000 K
540 lm

123943 € 3,50



Glim

Montatura interamente in metallo verniciato a polveri di colore bianco o nero. Diffusore orientabile con lampadina sostituibile.

LED Lampadine LED GU10 10W 3000 K incluse. Cod. **189031**









200194

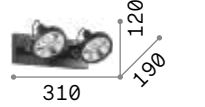
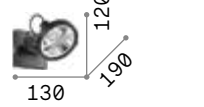

200231



P. 705

		
655	310	130
		
1,270 Kg / 0,0202 m ³ GU10 max 4 x 50W	0,890 Kg / 0,0074 m ³ GU10 max 2 x 50W	0,480 Kg / 0,0034 m ³ GU10 max 1 x 50W
€ 265	€ 145	€ 75
200217 Bianco 200255 Nero	200200 Bianco 200248 Nero	200194 Bianco 200231 Nero
 3000 K 800 lm	 3000 K 800 lm	 3000 K 800 lm
189031 € 15,00	189031 € 15,00	189031 € 15,00

Alfa

Montatura in metallo con finitura in bianco satinato o nickel satinato. Corpo luce posizionabile con rotazione dello stelo e snodo per l'inclinazione.

LED Lampadine LED GU10 7W 3000 K incluse. Cod. **123943**

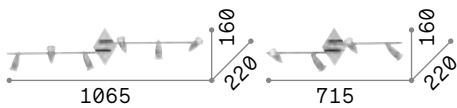

1,140 Kg / 0,0196 m³
GU10 max 6 x 50W

€ 135

122748 Bianco
006338 Nickel

1,070 Kg / 0,0158 m³
GU10 max 4 x 50W

€ 90

122731 Bianco
006321 Nickel

3000 K
540 lm

123943 € 3,50

3000 K
540 lm

123943 € 3,50



P. 427



Slem

Montatura in metallo con finitura in bianco, cromo o nickel satinato. Corpo luce posizionabile con rotazione dello stelo e snodo per l'inclinazione.

LED Lampadine LED GU10 7W 3000 K incluse. Cod. **123943**

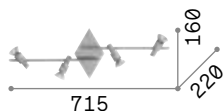

1,070 Kg / 0,0152 m³
GU10 max 4 x 50W

€ 92

142098 Bianco
142067 Cromo
018850 Nickel

3000 K
540 lm

123943 € 3,50



P. 427





Maracas

Montatura interamente in metallo rifinito in ottone satinato. Diffusori orientabili in vetro soffiato trasparente.

LED Lampadine LED G4 2W 3000 K incluse.
Cod. 222257



1,280 Kg / 0,0242 m³
G4 max 6 x 2W

€ 374

200361 **Ottone**

0,960 Kg / 0,0142 m³
G4 max 4 x 2W

€ 269

200354 **Ottone**

3000 K
200 lm

222257 € 4,00

3000 K
200 lm

222257 € 4,00



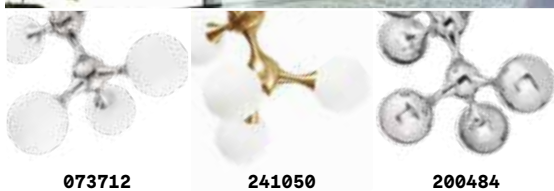

073712

241050

200484

Nodi

Montatura in metallo cromato oppure in ottone satinato. Diffusori in vetro bianco soffiato, acidato o trasparente e cromato.

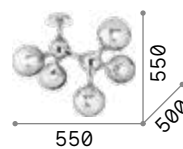

3,200 Kg / 0,1012 m³
E14 max 5 x 28W

€ 270

200484 Cromo

3000 K
480 lm

101200 € 2,50

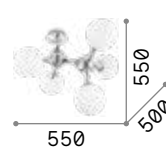

3,200 Kg / 0,1012 m³
E14 max 5 x 28W

€ 210

073712 Bianco
241050 Ottone

3000 K
480 lm

101200 € 2,50



P. 173



Nodino

Montatura in metallo con finitura in cromo o in vernice opaca bianca. Diffusori in vetro bianco soffiato e acidato.

LED Lampadine LED G9 4W 3000 K incluse.
Cod. **209043**

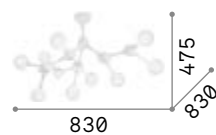

IP20

3,160 Kg / 0,3975 m³
G9 max 9 x 15W

€ 540

149622 Bianco
133393 Cromo

3000 K
510 lm
305486 € 6,00



Perlage **new**

Montatura in metallo con struttura lineare a sezione tonda o circolare a sezione quadrata. Diffusori in vetro soffiato. Finiture: nero opaco con vetri ambra o pirex fumé oppure ottone satinato con vetri bianchi acidati.

LED Lampadine LED G9 4W 3000 K incluse.
Cod. **209043**



328423



328416



328409

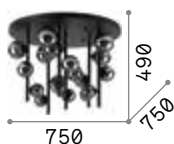

7,520 Kg / 0,1314 m³
G9 max 18 x 15W

€ 740

328393 **Bianco** **new**
328386 **Fumè** **new**
328379 **Ambra** **new**

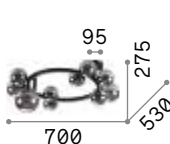

2,780 Kg / 0,0605 m³
G9 max 10 x 15W

€ 450

327815 **Bianco** **new**
309286 **Fumè** **new**
327808 **Ambra** **new**

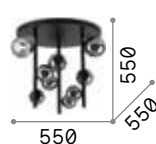

3,870 Kg / 0,0622 m³
G9 max 9 x 15W

€ 380

328423 **Bianco** **new**
328416 **Fumè** **new**
328409 **Ambra** **new**

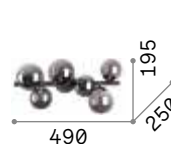

1,550 Kg / 0,0385 m³
G9 max 6 x 15W

€ 230

309279 **Bianco** **new**
309262 **Fumè** **new**
327822 **Ambra** **new**

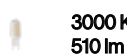

3000 K
510 lm

305486 € 6,00

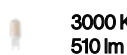

3000 K
510 lm

305486 € 6,00

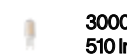

3000 K
510 lm

305486 € 6,00

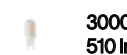

3000 K
510 lm

305486 € 6,00



P. 100



P. 435



P. 495



P. 524



Triumph

Base, bracci e copri porta lampade in metallo con finitura nero opaco o ottone invecchiato.



242378



160313

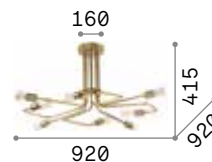

IP20

3,270 Kg / 0,0454 m³
E27 max 8 x 60W

€ 570

242378 ■ Nero
160313 ■ Ottone

2200 K
370 lm

151687 € 4,60



P. 092



P. 436



Birds

Montatura in metallo verniciato con disco decorativo in ottone satinato. Diffusori in vetro soffiato bianco acidato. Colore: nero opaco con dettaglio ottone satinato.

LED

Lampadine LED G9 4W 3000 K incluse.
Cod. **209043**

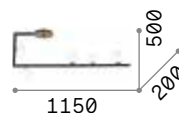

2,800 Kg / 0,1535 m³
G9 max 5 x 15W

€ 278

273631 ■ Nero

3000 K
510 lm

305486

€ 6,00



P. 099 P. 433 P. 494 P. 522



Pauline

Montatura in metallo cromato.
Elementi decorativi in vetro
trasparente modellato a mano e
cromato.



Lampadine LED G9 4W 3000 K incluse.
Cod. **209043**

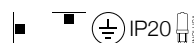
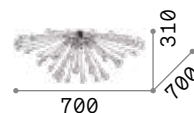

3,500 Kg / 0,0380 m³
G9 max 5 x 40W

€ 500

111117 ■ Fumè

3000 K
510 lm

305486 **€ 6,00**

Multiflex

Montatura in metallo rifinito con vernice opaca. Bracci flessibili metallici, rivestiti in gomma.

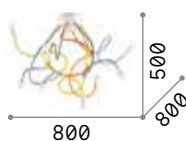

IP20

4,330 Kg / 0,0353 m³

E14 max 8 x 28W

€ 410

159010 Color

3000 K
420 lm

101217

€ 2,50

P. 175



Octopus

Base in metallo rifinito opaco. Bracci flessibili rivestiti di gomma di colore bianco o multicolor. Diffusori in vetro trasparente soffiato e sabbato.

LED Lampadine LED G9 4W 3000 K incluse.
Cod. 209043

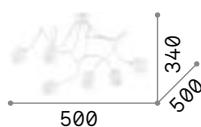

IP20

3,000 Kg / 0,0390 m³

G9 max 6 x 28W

€ 340

174921 Bianco

174976 Color

3000 K
510 lm

305486

€ 6,00



174921

174976



Gourmet

Rosone e montatura in metallo verniciato opaco. Diffusori in vetro incamiciato bianco, soffiato e acidato. Finiture: nero e ottone satinato.

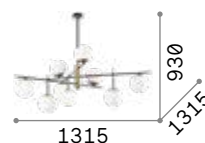

■ □ IP20

5,400 Kg / 0,1765 m³
E14 max 9 x 28W

€ 615

289489 ■ Nero

💡 3000K
420 lm

101217 € 2,50

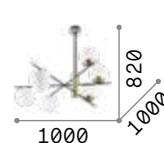

■ □ IP20

3,670 Kg / 0,1017 m³
E14 max 6 x 28W

€ 415

289496 ■ Nero

💡 3000K
420 lm

101217 € 2,50



Atlas new

Montatura in metallo verniciato opaco con bracci posizionabili. Diffusori in vetro soffiato bianco acidato. Finiture: bianco, nero, oro.

LED Lampadine LED G9 4W 3000 K incluse. Cod. **209043**

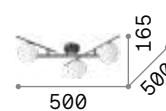
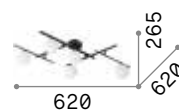

2,400 Kg / 0,0591 m³
G9 max 5 x 4W

1,500 Kg / 0,0397 m³
G9 max 3 x 4W

€ 250

€ 160

328225	■ Bianco	new	328201	■ Bianco	new
328218	■ Nero	new	311357	■ Nero	new
311364	■ Oro	new	311340	■ Oro	new

3000 K
510 lm

3000 K
510 lm

305486 € 6,00

305486 € 6,00



328201



311357



311340



Spark

Montatura in metallo verniciato
nero opaco con portalampane
placcati.

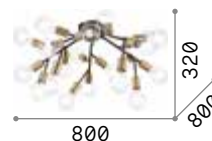

■ □ IP20

2,730 Kg / 0,0864 m³
E27 max 20 x 25W

€ 425

238333 ■ Nero

💡 3000 K
1120 lm

101323 € 7,00



P. 105



Cosmopolitan new

Montatura in metallo rifinito con vernice opaca. Diffusori in vetro soffiato bianco acidato. Colori: nero con dettagli ottone satinato.



Lampadine LED G9 4W 3000 K incluse.
Cod. **209043**

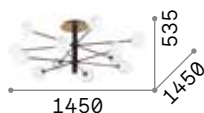

7,600 Kg / 0,1787 m³
G9 max 12 x 15W

€ 700

273709 ■ Nero

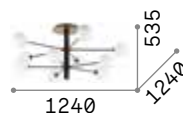

6,500 Kg / 0,1397 m³
G9 max 10 x 15W

€ 600

273693 ■ Nero

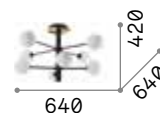

3,040 Kg / 0,0579 m³
G9 max 8 x 15W

€ 330

328485 ■ Nero new

3000 K
510 lm
305486 € 6,00

3000 K
510 lm
305486 € 6,00

3000 K
510 lm
305486 € 6,00



Angolo

Montatura in metallo verniciato a polveri o placcato. Diffusori in vetro bianco, soffiato e acidato. Finiture: nero oppure ottone satinato.

LED

Lampadine LED G9 4W 3000 K incluse.
Cod. **209043**



284286

284330



■ □ IP20

1,650 Kg / 0,0377 m³
G9 max 3 x 28W

€ 185

284286 ■ Nero
284330 ■ Ottone

■ **3000 K**
510 lm
305486 **€ 6,00**



P. 496 P. 526



Lingotto new

Montatura in metallo verniciato: base nera opaca e telaio ottone opaco oppure completamente nero opaco. Diffusori in vetro incamiciato bianco, soffiato e acidato.

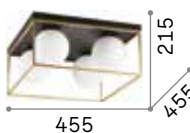

5,580 Kg / 0,0540 m³
E14 max 4 x 28W

€ 315

327860 ■ Nero new
198156 ■ Ottone



3,370 Kg / 0,0451 m³
E14 max 2 x 28W

€ 210

304137 ■ Nero new
198149 ■ Ottone



1,810 Kg / 0,0183 m³
E14 max 1 x 28W

€ 125

327853 ■ Nero new
198132 ■ Ottone

3000 K
420 lm
101217 € 2,50

3000 K
420 lm
101217 € 2,50

3000 K
420 lm
101217 € 2,50



P. 094



P. 497



Lumiere **new**

Montatura e dettagli in metallo verniciato nero opaco. Diffusore tubolare centrale bianco. Elementi decorativi in vetro soffiato bianco lucido e trasparente grigio.

LED

Sorgente luminosa LED 3000 K, 25.000 h di durata.



■ □ IP20

1,760 Kg / 0,0197 m³
LED 18W / 1450 lm

€ 150

314235 □ Bianco **new**



■ □ IP20

2,070 Kg / 0,0415 m³
LED 18W / 2350 lm

€ 170

314228 □ Bianco **new**



P. 176



P. 482



P. 520



Ping Pong new

Montatura in metallo rifinito con vernice a polveri. Diffusori con sfere in acrilico trasparente satinato. Driver integrato. Finiture: bianco, nero, ottone spazzolato.



LED Sorgente luminosa LED 3000 K, 50.000 h di durata.



■ ■ □ IP20

1,290 Kg / 0,0119 m³
LED 18W / 1500 lm

€ 230

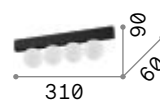

■ ■ □ IP20

0,860 Kg / 0,0077 m³
LED 11W / 1000 lm

€ 160

328256	■ Bianco	new	328232	■ Bianco	new
313290	■ Nero	new	313283	■ Nero	new
328263	■ Ottone	new	328249	■ Ottone	new

 P. 440
  P. 488
  P. 533



Binomio new

Montatura in metallo. Diffusori in vetro soffiato bianco acidato con fissaggio a vite. Finiture: bianco, nero, ottone spazzolato.

LED Lampadine LED G9 4W 3000 K incluse.
Cod. **209043**

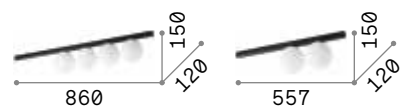

1,550 Kg / 0,0240 m³
G9 max 3 x 4W

€ 115

1,200 Kg / 0,0145 m³
G9 max 2 x 4W

€ 75

328454	■ Bianco	new	328430	■ Bianco	new
310688	■ Nero	new	310671	■ Nero	new
328461	■ Ottone	new	328447	■ Ottone	new

3000 K
510 lm

305486 € 6,00

3000 K
510 lm

305486 € 6,00



P. 441



Hermes new

Base e montatura in metallo placcato. Diffusori in vetro incamiciato bianco, soffiato e acidato. Finiture: bianco oppure ottone satinato.

LED

Lampadine LED G9 4W 3000 K incluse.
Cod. 209043



316680

288277

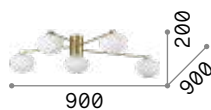

2,500 Kg / 0,0296 m³
G9 max 5 x 28W

€ 350

316680 **Bianco** new
288277 **Ottone**

305486 **3000 K**
510 lm

305486 € 6,00

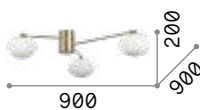

2,700 Kg / 0,0209 m³
G9 max 3 x 28W

€ 250

322674 **Bianco** new
288260 **Ottone**

305486 **3000 K**
510 lm

305486 € 6,00

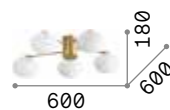

1,700 Kg / 0,0252 m³
G9 max 5 x 28W

€ 320

322698 **Bianco** new
316697 **Ottone**

305486 **3000 K**
510 lm

305486 € 6,00

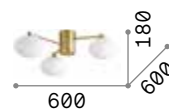

2,500 Kg / 0,0209 m³
G9 max 3 x 28W

€ 220

322667 **Bianco** new
317007 **Ottone** new

305486 **3000 K**
510 lm

305486 € 6,00



Ninfea

Base in metallo verniciato a polveri o placcato. Diffusori in vetro incamiciato bianco, soffiato e acidato. Finiture: bianco oppure ottone satinato.

LED Lampadine LED GX53 9W 3000 K incluse. Cod. **123936**



306957



293653



2,550 Kg / 0,0484 m³
GX53 max 3 x 15W

€ 250

306964 **Bianco**
293660 **Ottone**

3000 K
910 lm

123936 € 5,50

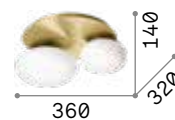

1,700 Kg / 0,0302 m³
GX53 max 2 x 15W

€ 175

306957 **Bianco**
293653 **Ottone**

3000 K
910 lm

123936 € 5,50





Penta **new**

Montatura in metallo. Diffusori in vetro soffiato bianco acidato con fissaggio a vite. Finiture: oro spazzolato.



Lampadine LED G9 4W 3000 K incluse.
Cod. **209043**



1,700 Kg / 0,0239 m³
G9 max 3 x 4W

€ 148

314822 Oro

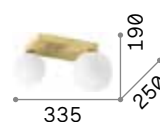

1,020 Kg / 0,0179 m³
G9 max 2 x 4W

€ 98

new 314815 Oro **new**

3000 K
510 lm
305486 € 6,00

3000 K
510 lm
305486 € 6,00



P. 443



Iride **new**

Base e montatura in metallo verniciato opaco. Diffusore in policarbonato opale ruvido. Finiture: bianco, nero.

LED Sorgente luminosa LED 3000 K, 30.000 h di durata.

312491



312507

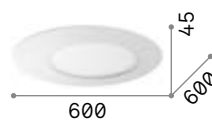

IP20

IP20

3,800 Kg / 0,0352 m³
LED 23W / 1900 lm

2,810 Kg / 0,0246 m³
LED 17W / 1450 lm

€ 193

€ 138

328362 **Bianco** **new** 312491 **Bianco** **new**
312507 **Nero** **new** 312477 **Nero** **new**



Daisy

Base in metallo rifinita con foglia oro. Diffusori in vetro soffiato bianco, acidato e con rigatura in rilievo.

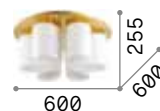

■ □ IP20

12,000 Kg / 0,1711 m³
E27 max 6 x 60W

€ 440

247779 ■ Oro

💡 3000 K
900 lm

123899 € 6,00



Compo

Montatura in metallo cromato o verniciato bianco opaco. Elementi diffusori in vetro soffiato bianco incamiciato e acidato o trasparente fumè.



125503



172828



IP20

17,200 Kg / 0,3008 m³
E27 max 10 x 60W

€ 1000

125510 ■ Bianco
172804 ■ Fumè

 3000 K
910 lm

119571 € 6,00



IP20

9,900 Kg / 0,1918 m³
E27 max 6 x 60W

€ 570

125503 ■ Bianco
172828 ■ Fumè

 3000 K
910 lm

119571 € 6,00



Roma

Montatura e dettagli in metallo cromato. Diffusore con elementi quadrati in cristallo molato sulla fascia laterale e vetro sabbato sul fondo.



Lampadine LED G9 4W 3000 K incluse.
Cod. 209043

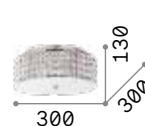
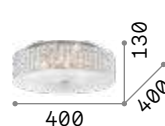
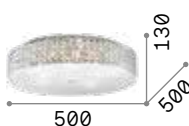
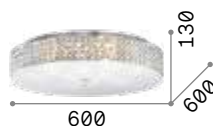

9,600 Kg / 0,1220 m³
G9 max 12 x 40W

6,800 Kg / 0,0905 m³
G9 max 9 x 40W

4,800 Kg / 0,0588 m³
G9 max 6 x 40W

2,500 Kg / 0,0390 m³
G9 max 4 x 40W

€ 640

€ 560

€ 385

€ 270

087870 Cromo

087863 Cromo

000657 Cromo

093093 Cromo



P. 205 P. 454 P. 510

3000 K
510 lm

305486 € 6,00

3000 K
510 lm

305486 € 6,00

3000 K
510 lm

305486 € 6,00

3000 K
510 lm

305486 € 6,00



Pashà

Montatura in metallo. Diffusore composto da filari di perle in cristallo molato e fondo chiuso da vetro circolare sabbato.



164991



165004



P. 207 P. 454



13,000 Kg / 0,1809 m³
E14 max 14 x 40W

€ 1145

164991 Cromo
165004 Oro

3000 K
480 lm
101200 € 2,50



8,800 Kg / 0,1040 m³
E14 max 10 x 40W

€ 980

100746 Cromo
100791 Oro

3000 K
480 lm
101200 € 2,50



6,200 Kg / 0,0529 m³
E14 max 6 x 40W

€ 780

100784 Cromo
100807 Oro

3000 K
480 lm
101200 € 2,50



King

Diffusore composto da anelli in metallo cromato o dorato con ottagoni di cristallo incastonati all'interno.

LED

Lampadine LED G9 4W 3000 K incluse.
Cod. **209043**



073255



073262



P. 200

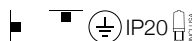

6,250 Kg / 0,0946 m³
G9 max 9 x 40W

€ 665

073255 Cromo
073262 Oro

3000 K
510 lm

305486 € 6,00

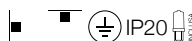
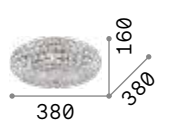

3,200 Kg / 0,0487 m³
G9 max 5 x 40W

€ 380

075419 Cromo
073187 Oro

3000 K
510 lm

305486 € 6,00

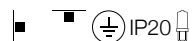

1,750 Kg / 0,0240 m³
G9 max 3 x 40W

€ 220

075389 Cromo
075402 Oro

3000 K
510 lm

305486 € 6,00



Admiral

Diffusore composto da anelli in metallo saldati tra loro e da elementi in cristallo molato incastonati all'interno.

LED Lampadine LED G9 4W 3000 K incluse.
Cod. **209043**



7,050 Kg / 0,0731 m³ G9 max 8 x 40W	4,580 Kg / 0,0486 m³ G9 max 6 x 40W	3,000 Kg / 0,0318 m³ G9 max 4 x 40W
€ 778	€ 500	€ 340
080352 Cromo	080345 Cromo	080338 Cromo
3000 K 510 lm	3000 K 510 lm	3000 K 510 lm
305486 € 6,00	305486 € 6,00	305486 € 6,00



Armony **new**

Montatura in metallo verniciato opaco. Elementi decorativi pendenti in filo metallico con perle di vetro trasparente cromato. Finiture: bianco.

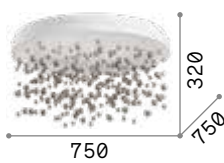
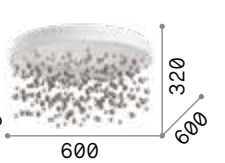
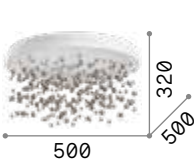

LED Sorgente luminosa LED 3000 K, 30.000 h di durata.

		
750 750 320	600 600 320	500 500 320
■ □ IP20	■ □ IP20	■ □ IP20
10,500 Kg / 0,0961 m ³ LED 77W / 6750 lm	7,830 Kg / 0,0634 m ³ LED 61W / 5600 lm	5,050 Kg / 0,0393 m ³ LED 53W / 4750 lm
€ 600	€ 450	€ 315
315812 Bianco new	315805 Bianco new	328492 Bianco new



101187

022239

Neve

Montatura in metallo. Elementi decorativi con sfere di vetro fissate a fili di nylon. Disponibile con montatura cromata e sfere trasparenti o con montatura in bianco opaco e sfere bianche e trasparenti.



Lampadine LED G9 4W 3000 K incluse.
Cod. 209043

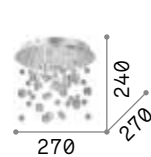
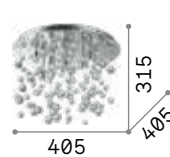
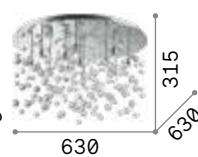
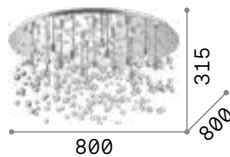

11,250 Kg / 0,1524 m³
G9 max 15 x 40W

7,420 Kg / 0,0920 m³
G9 max 12 x 40W

3,590 Kg / 0,0344 m³
G9 max 8 x 40W

1,500 Kg / 0,0149 m³
G9 max 5 x 40W

€ 760

€ 510

€ 305

€ 155

101194 Bianco
030784 Cromo

101187 Bianco
022239 Cromo

101170 Bianco
022222 Cromo

094687 Cromo

3000 K
510 lm

3000 K
510 lm

3000 K
510 lm

3000 K
510 lm

305486 € 6,00

305486 € 6,00

305486 € 6,00

305486 € 6,00

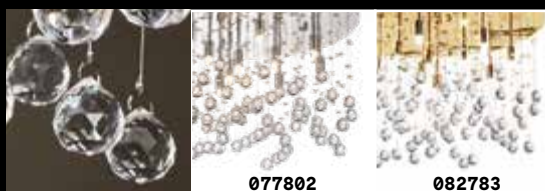

Moonlight

Montatura in metallo con finitura disponibile in cromo o dorato.
Pendagli con ottagononi e sfere in cristallo molato.

LED Lampadine LED G9 4W 3000 K incluse.
Cod. 209043

IP20	IP20	IP20	IP20
11,800 Kg / 0,1524 m ³ G9 max 15 x 40W	6,000 Kg / 0,0933 m ³ G9 max 12 x 40W	2,900 Kg / 0,0398 m ³ G9 max 8 x 40W	1,500 Kg / 0,0144 m ³ G9 max 5 x 40W
€ 875	€ 605	€ 338	€ 170
077819 Cromo 082790 Oro	077802 Cromo 082783 Oro	077796 Cromo 080932 Oro	094649 Cromo 094663 Oro
3000 K 510 lm	3000 K 510 lm	3000 K 510 lm	3000 K 510 lm
305486 € 6,00	305486 € 6,00	305486 € 6,00	305486 € 6,00

Royal

Montatura circolare e portalampe in metallo cromato. Pendagli con elementi in cristallo molato ottagonali, quadrati, rettangolari e gocce finali.

LED Lampadine LED G9 4W 3000 K incluse. Cod. **209043**

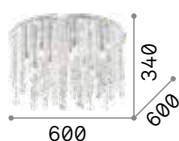

IP20

5,900 Kg / 0,0881 m³
G9 max 12 x 40W

€ 590

053004 Cromo

305486 3000 K
510 lm € 6,00

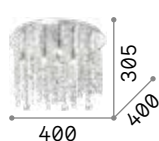

IP20

2,840 Kg / 0,0379 m³
G9 max 8 x 40W

€ 310

052991 Cromo

305486 3000 K
510 lm € 6,00



Rain

Montatura in metallo cromato. Pendagli con elementi in cristallo molato in varie forme e gocce finali.

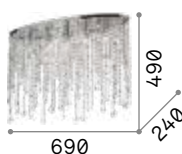

IP20

3,820 Kg / 0,0225 m³
E14 max 5 x 40W

€ 340

008455 Cromo

101224 3000 K
470 lm € 2,50

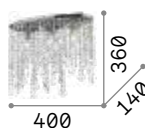

IP20

1,800 Kg / 0,0094 m³
E14 max 3 x 40W

€ 170

008370 Cromo

101224 3000 K
470 lm € 2,50



P. 202



Magnolia

Montatura in metallo con finitura oro. Elementi decorativi in cristallo molato trasparente. Nella parte superiore si alternano elementi trasparenti ed elementi fumè.

LED Lampadine LED G9 4W 3000 K incluse.
Cod. **209043**

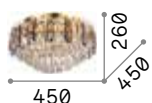

9,780 Kg / 0,0984 m³

G9 max 7 x 15W

€ 620

241296 **Oro**

3000 K
510 lm

305486 € 6,00

Dubai

Montatura in metallo con finitura cromo o ottone. Elementi decorativi con perle, ottagononi e prismi in cristallo molato trasparente.

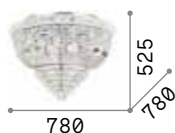

14,290 Kg / 0,3881 m³

E14 max 24 x 28W

€ 1430

243566 **Cromo**
243498 **Ottone**

3000 K
470 lm

101224 € 2,50

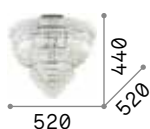

6,310 Kg / 0,1413 m³

E14 max 6 x 28W

€ 950

207186 **Cromo**
201016 **Ottone**

3000 K
470 lm

101224 € 2,50

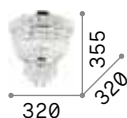

3,010 Kg / 0,0392 m³

E14 max 3 x 28W

€ 475

207162 **Cromo**
200996 **Ottone**

3000 K
470 lm

101224 € 2,50



P. 210



P. 455



207186



201016



Martinez

Montatura in metallo cromato o dorato. Elementi decorativi con catene di ottagoni e barre in cristallo molato trasparente.



166285



213569

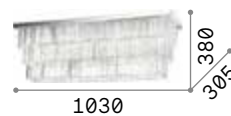

IP20

17,500 Kg / 0,0807 m³
E14 max 8 x 40W

€ 770

166285 Cromo
213569 Oro

3000 K
470 lm

101224 € 2,50



P. 203



Carlton

Montatura in metallo cromato o dorato. Elementi decorativi con catene di ottoni e barre in cristallo molato trasparente.



168937



213507

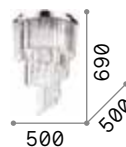

IP20

13,840 Kg / 0,1563 m³
E14 max 12 x 40W

€ 725

168937 Cromo
213507 Oro

3000 K
470 lm

101224 € 2,50

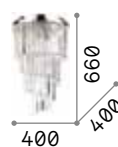

IP20

10,200 Kg / 0,1066 m³
E14 max 8 x 40W

€ 625

168920 Cromo

3000 K
470 lm

101224 € 2,50



Interni

Lampade da parete

Indice alfabetico

Alfa	427	Equinoxe	437	Mirror-20	409	Roma	454
Ali	399	Essence	402	Moris	378	Rudy	423
Alma	406	Filo	404	Mouse	422	Santa	463
Balance	382	Firenze	460	Negresco	458	Set Up	446
Barber	426	Fix	378	Newton	438	Shower	439
Bean	414	Flash	390	Ninfea	443	Sky	392
Binomio	441	Flash Gesso	391	Nordik	450	Slem	427
Birds	433	Florian	458	Oby	426	Smarties	397
Book	421	Focus	410	Opera	456	Soda	395
Bow	408	Frida	431	Ovalino	394	Spot	422
Box	379	Gea	453	Oz	374	Strauss	459
Bright	384	Gim	424	Page	415	Sunrise	445
Calypso	454	Gioconda	459	Pan	442	Swan	456
Camerino	400	Goose	412	Pashà	454	Syntesi	375
Cantina	438	Harem	462	Paul	394	Theo	405
Carlton	455	Hilton	448	Pegaso	457	Tick	444
Carta	397	Holiday	450	Peggy	377	Triplo	398
Chalet	460	Hotel	451	Penta	443	Triumph	436
Click	383	Igor	432	Perlage	435	Tudor	399
Clip	381	Io	411	Peter	461	Virtus	383
Corte	457	Kepler	434	Piano	418	Winery	428
Cover	376	Kid	452	Ping Pong	440	Woody	449
Craft	386	Komodo	419	Pipe	416	Zig Zag	389
Cube	382	Linus	387	Posta	380		
Delta	385	Lite	417	Pouche	377		
Desk	386	Look	393	Pretty	400		
Dodo	425	Luxury	450	Privè	401		
Dubai	455	Make Up	407	Probe	420		
Dynamo	413	Mapa Bianco	396	Radio	429		
Echo	388	Maracas	436	Read	420		
Eclissi	445	Minimal	430	Retrò	409		
Edison	428	Mirror-10	408	Riflesso	407		

Carta

Pag 397



370



Oz 374



Syntesi 375



Clip 381



Cube 382



Linus 387



Echo 388



Soda 395

new



MapaBianco 396



Privè 401



Essence 402



Retrò 409



Mirror-20 409



Lite 417



Piano 418



Gim 424



























new



Dodo 425





































Interni

Indice icone

						
Cover 376	Peggy 377	Pouche 377	Fix 378	Moris 378	Box 379	Posta 380
new						
Balance 382	Virtus 383	Click 383	Bright 384	Delta 385	Desk 386	Craft 386
						
Zig Zag 389	Flash 390	FlashGesso 391	Sky 392	Look 393	Paul 394	Ovalino 394
	new					
Smarties 397	Carta 397	Triplo 398	Ali 399	Tudor 399	Camerino 400	Pretty 400
new	new					new
Filo 404	Theo 405	Alma 406	Make Up 407	Riflesso 407	Bow 408	Mirror-10 408
						
Focus 410	IO 411	Goose 412	Dynamo 413	Bean 414	Page 415	Pipe 416
						new
Komodo 419	Probe 420	Read 420	Book 421	Mouse 422	Spot 422	Rudy 423
						
Oby 426	Barber 426	Alfa 427	Slem 427	Winery 428	Edison 428	Radio 429

Interni

Indice icone

						
Minimal 430	Frida 431	Igor 432	Birds 433	Kepler 434	Perlage 435	Triumph 436
						
Cantina 438	Newton 438	Shower 439	Ping Pong 440	Binomio 441	Pan 442	Penta 443
						
Eclissi 445	Sunrise 445	Set Up 446	Hilton 448	Woody 449	Luxury 450	Nordik 450
						
Kid 452	Gea 453	Calypso 454	Roma 454	Pashà 454	Carlton 455	Dubai 455
						
Corte 457	Pegaso 457	Negresco 458	Florian 458	Gioconda 459	Strauss 459	Firenze 460
						
Harem 462	Santa 463					



Maracas 436



Equinoxe 437



Ninfea 443



Tick 444



Holiday 450



Hotel 451



Opera 456



Swan 456



Chalet 460



Peter 461



Binomio

Pag 441



Oz

Base e montatura in metallo verniciato a polveri o placcato. Diffusore in gomma opale. Disponibile nelle finiture bianco, nero o ottone spazzolato. Disponibile anche in versione dimmerabile DALI/Push.

LED Sorgente luminosa LED 3000 K, 30.000 h di durata.

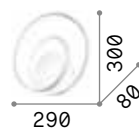

■ IP20

0,800 Kg / 0,0087 m³
LED 28W / 2500 lm

€ 190 On-Off / 255 Dali

253695	Bianco	On-Off
304489	Bianco	Dali/Push
269399	Nero	On-Off
304496	Nero	Dali/Push
269405	Ottone	On-Off
304502	Ottone	Dali/Push

P. 062 P. 257 P. 468



Syntesi

Struttura e corpo luce in alluminio verniciato a polveri. Diffusore orientabile con schermo in acrilico trasparente zigrinato. Colore: nero.

LED Sorgente luminosa LED 3000 K, 30.000 h di durata.

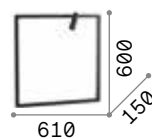

■ □ IP20

1,140 Kg / 0,0696 m³
LED 5W / 500 lm

€ 270

271897 ■ Nero

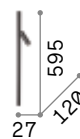

■ □ IP20

0,200 Kg / 0,0047 m³
LED 3W / 350 lm

€ 150

271880 ■ Nero



Cover

Corpo luce in alluminio verniciato a polveri di colore bianco o nero. Diffusore in materiale plastico opale. Sorgente luminosa a led integrati con emissione di luce riflessa.

LED Sorgente luminosa LED 3000 K, 30.000 h di durata.

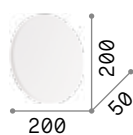

■ ■ □ IP20

0,690 Kg / 0,0028 m³
LED 11W / 1000 lm

€ 100

195711 ■ Bianco
195759 ■ Nero

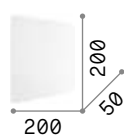

■ ■ □ IP20

0,860 Kg / 0,0028 m³
LED 11W / 1000 lm

€ 100

195735 ■ Bianco
195773 ■ Nero

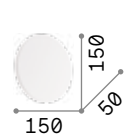

■ ■ □ IP20

0,390 Kg / 0,0018 m³
LED 9,5W / 830 lm

€ 88

195704 ■ Bianco
195742 ■ Nero

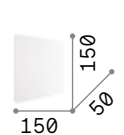

■ ■ □ IP20

0,510 Kg / 0,0018 m³
LED 9,5W / 830 lm

€ 88

195728 ■ Bianco
195766 ■ Nero

Peggy

Base e montatura in metallo verniciato a polveri con finitura bianca. Diffusore in acrilico satinato. Emissione luce indiretta.

LED Sorgente luminosa LED 3000 K, 50.000 h di durata.

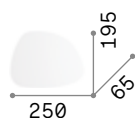

■ IP20

0,710 Kg / 0,0068 m³
LED 16,5W / 1500 Lm

€ 170

257242 Bianco

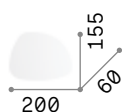

■ IP20

0,520 Kg / 0,0030 m³
LED 10,5W / 1080 Lm

€ 110

257235 Bianco



Pouche

Montatura in metallo rifinito con vernice a polveri di colore bianco. Diffusore in acrilico trasparente satinato. Emissione luce indiretta.

LED Sorgente luminosa LED 3000 K, 20.000 h di durata.



■ IP20

1,440 Kg / 0,0055 m³
LED 14W / 1300 Lm

€ 110

259352 Bianco



■ IP20

1,120 Kg / 0,0055 m³
LED 14W / 1300 Lm

€ 110

259345 Bianco



Fix

Base in metallo con finitura bianca opaca. Diffusore-dissipatore in lastra d'alluminio da 6 mm di spessore. LED integrati.

LED Sorgente luminosa LED 3000 K, 20.000 h di durata.

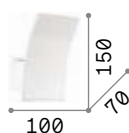

■ □ IP20

0,390 Kg / 0,0050 m³

LED 5,5W / 440 lm

€ 95

117867 ■ Bianco



Moris

Montatura in metallo cromato.
Diffusore in vetro soffiato bianco.

LED Lampadine LED G9 4W 3000 K incluse.
Cod. 209043



■ □ IP20

0,520 Kg / 0,0071 m³

G9 max 2x40W

€ 90

034546 ■ Bianco

■ 3000 K
510 lm

305486 € 6,00





Box

Montatura in metallo cromato.
Diffusore in vetro soffiato,
incamiciato e acidato. Bianco
all'interno e colorato all'esterno.



Lampadine LED G9 4W 3000 K incluse.
Cod. **209043**



0,660 Kg / 0,0100 m³
G9 max 2 x 40W

€ 80

009537 ■ Bianco
009513 ■ Nero

3000 K
510 lm

305486 € 6,00



Posta

Corpo luce in metallo disponibile in alluminio spazzolato o smaltato bianco. Diffusore composto di tre vetri trasparenti smerigliati.



051963



009940



620



1,560 Kg / 0,0156 m³
E14 max 4 x 40W

€ 95

051987 Bianco
009957 Alluminio

3000 K
480 lm

101200 € 2,50



500



1,270 Kg / 0,0136 m³
E14 max 3 x 40W

€ 87

051970 Bianco
009933 Alluminio

3000 K
480 lm

101200 € 2,50



360



0,950 Kg / 0,0098 m³
E14 max 2 x 40W

€ 75

051963 Bianco
009940 Alluminio

3000 K
480 lm

101200 € 2,50



Clip

Corpo luce interamente in lamina di metallo con varie finiture. Nella versione piccola, diffusori in vetro pirex sabbato.

LED

Lampadine LED G9 4W 3000 K incluse nei modelli: **049236**, **091136**, **049229**, **091129** e **170923**. Cod. **209043**

	014166		
	088273		
	031361		
	088266	1,210 Kg / 0,0161 m³ E27 max 2 x 60W	0,680 Kg / 0,0035 m³ G9 max 2 x 40W
	187365	€ 107	€ 95
		014166 Bianco	049236 Bianco
		088273 Argento	091136 Argento
		031361 Cromo	049229 Cromo
		088266 Oro	091129 Oro
		187365 Coffee	170923 Coffee
		3000 K 430 lm	3000 K 510 lm
		101279 € 2,60	305486 € 6,00

Cube

Corpo luce dissipatore interamente in lastra d'alluminio da 6 mm di spessore. Rifinito con vernice a polveri. LED integrati.

LED Sorgente luminosa LED 3000 K, 30.000 h di durata.

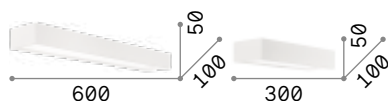

■ IP20

1,390 Kg / 0,0055 m³
LED 14,5W / 1900 lm

€ 195

161792 ■ Bianco

■ IP20

0,800 Kg / 0,0028 m³
LED 8W / 950 lm

€ 145

161785 ■ Bianco



Balance ^{new}

Montatura in alluminio verniciato a polveri. Diffusore orientabile a vetro trasparente, smerigliato all'interno. Finiture: bianco, nero.

LED Sorgente luminosa LED 3000 K, 30.000 h di durata.



■ IP20

2,200 Kg / 0,0111 m³
LED 24W / 3100 lm

€ 275

287584 ■ Bianco
321561 ■ Nero

■ IP20

1,600 Kg / 0,0073 m³
LED 17W / 2200 lm

€ 198

new 287577 ■ Bianco
new 321554 ■ Nero

■ IP20

1,200 Kg / 0,0056 m³
LED 12W / 1450 lm

€ 160

new 287560 ■ Bianco
new 321547 ■ Nero



Virtus

Montatura in metallo verniciato a polveri. Diffusore in acrilico satinato. Emissione luminosa diffusa, sopra, sotto e frontale. Colore: bianco.

LED Sorgente luminosa LED 3000/4000 K, 15.000 h di durata.

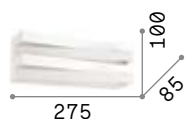

IP20

0,980 Kg / 0,0035 m³
LED 17W / 1800/1900 Lm

€ 115

267760 Bianco 3000K
255989 Bianco 4000K



Click

Corpo luce interamente in alluminio verniciato a polveri con finitura bianca. Struttura interna che riflette il fascio luminoso sia sopra che sotto.

LED Sorgente luminosa LED 3000 K, 20.000 h di durata.

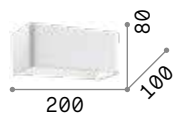

IP20

0,600 Kg / 0,0040 m³
LED 10,5W / 1050 lm

€ 84

017518 Bianco

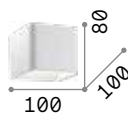

IP20

0,400 Kg / 0,0019 m³
LED 5,5W / 500 lm

€ 62

051444 Bianco





Bright

Corpo luce interamente in alluminio con finitura bianca. Fascio luminoso orientato sia verso l'alto che verso il basso.

LED

Sorgente luminosa LED 3000 K, 30.000 h di durata.

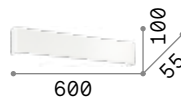

■ □ IP20

1,660 Kg / 0,0101 m³
LED 23W / 1650 lm

€ 215

131962 Bianco

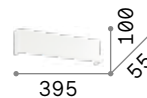

■ □ IP20

1,120 Kg / 0,0064 m³
LED 15,5W / 1100 lm

€ 160

134789 Bianco

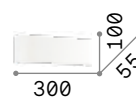

■ □ IP20

0,930 Kg / 0,0051 m³
LED 11W / 820 lm

€ 125

134796 Bianco



Delta

Corpo luce in alluminio verniciato a polveri. Diffusori in policarbonato opale lucido. Emissione luce sopra e sotto. Finiture: bianco oppure nero.

LED Sorgente luminosa LED 3000/4000 K, 50.000 h di durata.

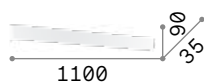

■  IP20

2,400 Kg / 0,0102 m³
LED 37W / 4550/4800 lm

€ 185

287607	Bianco	3000K
307053	Bianco	4000K
287591	Nero	3000K
307060	Nero	4000K

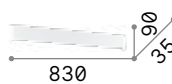

■  IP20

0,900 Kg / 0,0078 m³
LED 30W / 3600/3800 lm

€ 160

287621	Bianco	3000K
307039	Bianco	4000K
287614	Nero	3000K
307046	Nero	4000K

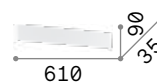

■  IP20

0,950 Kg / 0,0058 m³
LED 19,5W / 2050/2150 lm

€ 110

287645	Bianco	3000K
307015	Bianco	4000K
287638	Nero	3000K
307022	Nero	4000K



287645



287638

Desk

Corpo luce in alluminio verniciato a polveri con finitura bianca o nera. Diffusori in acrilico satinato. Emissione luce sopra e sotto.

LED Sorgente luminosa LED 3000 K, 30.000 h di durata.



■  IP20

0,640 Kg / 0,0045 m³

LED 12,5W / 1150 lm

€ 125

138251 ■ Bianco

173252 ■ Nero



P. 084



Craft

Base in metallo verniciato nero opaco. Corpo luce in legno naturale. Diffusore in policarbonato opale satinato. Emissione luce verso il basso.

LED Sorgente luminosa LED 3000 K, 20.000 h di durata.

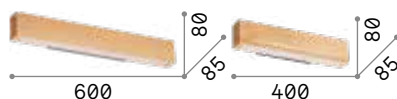

■  IP20

1,000 Kg / 0,0083 m³

LED 18W / 2200 lm

€ 210

284491 ■ Legno

■  IP20

0,800 Kg / 0,0057 m³

LED 13W / 1550 lm

€ 145

284477 ■ Legno



P. 085



P. 538





Linus

Lampada lineare in alluminio con illuminazione diretta e indiretta per applicazione a parete. La lampada è modulare e può essere proposta singolarmente oppure in linea continua. È disponibile in finitura bianca o nera. LED integrati; binning iniziale \leq 3-Step MacAdam; disponibile in temperatura di colore 3000 K e 4000 K; CRI \geq 80. Alimentatore dimmerabile 1-10V integrato di serie.

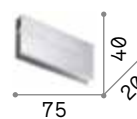

1,250 Kg / 0,0158 m³
LED 32W / 3450/3600 lm

€ 210

233840	Bianco	3000K
268095	Bianco	4000K
242019	Nero	3000K
268071	Nero	4000K

Connector
Non incluso
Optional

€ 6

233666

LED Sorgente luminosa LED 3000/4000 K, 50.000 h di durata.

+ Lampada con dimmer.



P. 630



Echo

Base e diffusore interamente in alluminio verniciato a polveri o placcato. Emissione luce indiretta. Colori: bianco, nero, ottone satinato.

LED Sorgente luminosa LED 3000 K, 50.000 h di durata.

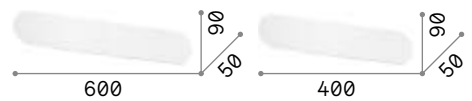

■ IP20

0,930 Kg / 0,0051 m³
LED 30W / 3850 lm

€ 160

273945 Bianco
285306 Nero
285313 Ottone

■ IP20

0,640 Kg / 0,0032 m³
LED 20W / 2250 lm

€ 140

273914 Bianco
285283 Nero
285290 Ottone



Zig Zag

Corpo luce dissipatore interamente in lastra d'alluminio da 6 mm di spessore. Rifinito con vernice a polveri di colore bianco, nero o placcato ottone, cromo oppure rame. LED integrati.

LED Sorgente luminosa LED 3000/4000 K, 50.000 h di durata.



■ IP20

1,040 Kg / 0,0047 m³
LED 30W / 4100/4300 lm

€ 135

277219	Bianco	3000K
277257	Bianco	4000K
307183	Cromo	3000K
277226	Nero	3000K
287072	Ottone	3000K
307190	Rame	3000K

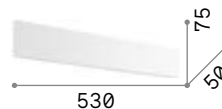

■ IP20

0,590 Kg / 0,0029 m³
LED 23W / 2900/3050 lm

€ 103

179308	Bianco	3000K
277240	Bianco	4000K
282152	Cromo	3000K
179322	Nero	3000K
282138	Ottone	3000K
282176	Rame	3000K

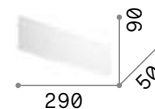

■ IP20

0,450 Kg / 0,0020 m³
LED 12,5W / 1450/1550 lm

€ 90

179292	Bianco	3000K
277233	Bianco	4000K
282145	Cromo	3000K
179315	Nero	3000K
282121	Ottone	3000K
282169	Rame	3000K



Flash

Montatura in metallo rifinito in vernice opaca di colore bianco. Emette luce sopra e sotto.



Lampadine LED G9 4W 3000 K incluse.
Cod. **209043**

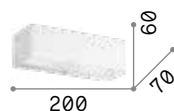

0,360 Kg / 0,0012 m³
G9 max 2 x 40W

€ 62

095288 Bianco

3000 K
510 lm
305486 € 6,00



0,200 Kg / 0,0005 m³
G9 max 1 x 40W

€ 34

095264 Bianco

3000 K
510 lm
305486 € 6,00



Flash Gesso

Base in metallo smaltato. Corpo luce interamente in gesso. Doppia emissione luminosa: sopra e sotto.



Articolo adatto alla pittura e verniciatura.



214689 214672



214696

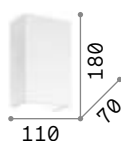

■ IP20

0,710 Kg / 0,0049 m³
G9 max 1x 40W

€ 51

214689 Bianco

3000 K
510 lm

305486 € 6,00

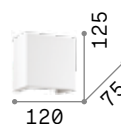

■ IP20

0,770 Kg / 0,0024 m³
G9 max 1x 40W

€ 49

214672 Bianco

3000 K
510 lm

305486 € 6,00

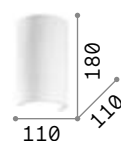

■ IP20

0,950 Kg / 0,0034 m³
G9 max 1x 40W

€ 45

214696 Bianco

3000 K
510 lm

305486 € 6,00



Sky

Base e diffusore in metallo placcato o verniciato opaco o decorato in foglia d'oro.



Lampadine LED GU10 7W 3000 K
incluse. Cod. **123943**



126883 **126890** **136899**

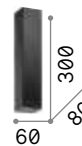

0,940 Kg / 0,0049 m³
GU10 max 2 x 28W

€ 116

126883 ■ Bianco
126890 ■ Nero
136899 ■ Oro

3000 K
540 lm

123943 **€ 3,50**



P. 077



P. 311



Look

Corpo luce in metallo con finitura rame, cromo, brunito o vernice opaca di colore bianco o nero.



Lampadine LED GU10 7W 3000 KK
includ. Cod. **123943**

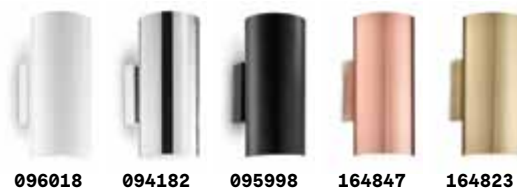

096018

094182

095998

164847

164823

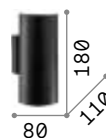

0,500 Kg / 0,0028 m³
GU10 max 2x28W

€ 80

096018 Bianco
094182 Cromo
095998 Nero
164847 Rame
164823 Brunito

3000 K
540 lm

123943

€ 3,50



P. 074



P. 310



P. 534



P. 708

Paul

Base in metallo rifinito con vernice opaca. Diffusore in vetro soffiato, incamiciato e acidato. Disponibile con finitura bianca.

LED Lampadine LED G9 4W 3000 K incluse.
Cod. **209043**



0,560 Kg / 0,0064 m³
G9 max 2 x 40W

0,540 Kg / 0,0056 m³
G9 max 2 x 40W

€ 65

€ 65

060620 Bianco

231129 Bianco

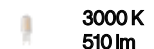
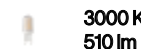

305486 € 6,00

305486 € 6,00

Ovalino

Diffusore composto da elementi circolari in lastra di vetro curvata e acidata.



1,800 Kg / 0,0563 m³
E27 max 2 x 60W

€ 125

038025 Bianco

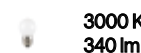

101286 € 2,60

P. 155 P. 394



Soda

Corpo luce in gesso bianco. Base in metallo smaltato bianco. Diffusore inferiore in vetro trasparente satinato. Emissione luce sia sopra che sotto.



Articolo adatto alla pittura e verniciatura.

510	300
■ IP20	■ IP20
2,630 Kg / 0,0154 m³	1,100 Kg / 0,0068 m³
E14 max 2x 40W	E14 max 1x 40W
€ 100	€ 65
105727 Bianco	105710 Bianco
3000 K 420 lm	3000 K 420 lm
101217 € 2,50	101217 € 2,50



Mapa Bianco new

Base e sistema di fissaggio in metallo bianco. Diffusore a sfera in vetro bianco soffiato e acidato.

LED Lampadine LED G9 4W 3000 K incluse nei modelli: **059808** e **310787**.
Cod. **209043**

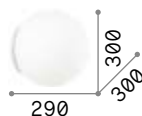

1,660 Kg / 0,0647 m³
E27 max 1x60W

€ 88

059822 Bianco

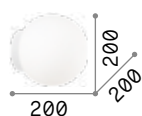

0,900 Kg / 0,0259 m³
E27 max 1x60W

€ 50

059815 Bianco

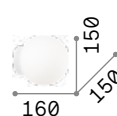

0,380 Kg / 0,0115 m³
G9 max 1x15W

€ 44

059808 Bianco

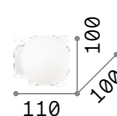

0,230 Kg / 0,0025 m³
G9 max 1x15W

€ 35

310787 Bianco new



P. 164 P. 292 P. 487

3000 K
430 lm
101279 € 2,60

3000 K
430 lm
101279 € 2,60

3000 K
510 lm
305486 € 6,00

3000 K
510 lm
305486 € 6,00

Smarties

Base in metallo. Diffusore in vetro soffiato bianco acidato con sistema di fissaggio senza viti.

LED Lampadine LED G9 4W 3000 K incluse.
Cod. **209043**

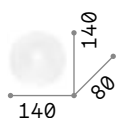

IP20

0,440 Kg / 0,0079 m³

G9 max 1x 15W

€ 46

014814 Bianco

305486 3000 K
510 lm

€ 6,00



P. 152

P. 287

P. 485



Carta ^{new}

Montatura in metallo verniciato bianco opaco. Diffusore in policarbonato con rivestimento ad effetto carta.

LED Lampadine LED G9 4W 3000 K incluse nel modello **317090**. Cod. **209043**

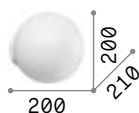

IP20

0,500 Kg / 0,0127 m³

E27 max 1x 25W

€ 85

317106 Bianco

101279 3000 K
430 lm

€ 2,60

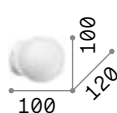

IP20

0,200 Kg / 0,0027 m³

G9 max 1x 15W

€ 65

new 317090 Bianco new

305486 3000 K
510 lm

€ 6,00



P. 166 P. 293 P. 484 P. 545



Triplo

Diffusore con triplo vetro, uno trasparente e piano alla base e due smerigliati ad acido e ricurvi sulla parte superiore. Elementi ferma vetro in metallo cromato.



■  IP20

2,170 Kg / 0,0181 m³
E27 max 2 x 60W

€ 70

026480 Bianco

 3000 K
340 lm

101286 € 2,60

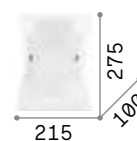

■  IP20

1,260 Kg / 0,0141 m³
E27 max 1 x 60W

€ 48

026473 Bianco

 3000 K
340 lm

101286 € 2,60

Ali

Diffusore in vetro bianco acidato composto da tre elementi: due laterali e uno frontale. Viti fermavetro cromate.

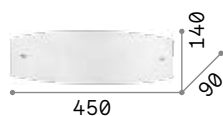

IP20

1,410 Kg / 0,0157 m³

E27 max 2 x 60W

€ 57

026558 Bianco

3000 K
340 lm

101286 € 2,60



Tudor

Base in metallo cromato. Diffusore composto da cornice in vetro trasparente molato e mezzo tubo in vetro pirex sabbato nella parte centrale.

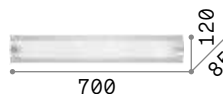

IP20

1,900 Kg / 0,0214 m³

E14 max 4 x 40W

€ 100

051864 Trasparen.

3000 K
420 lm

101217 € 2,50

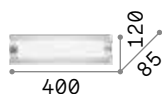

IP20

1,130 Kg / 0,0088 m³

E14 max 2 x 40W

€ 70

051857 Trasparen.

3000 K
420 lm

101217 € 2,50

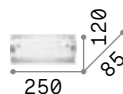

IP20

0,700 Kg / 0,0077 m³

E14 max 1 x 40W

€ 50

051840 Trasparen.

3000 K
420 lm

101217 € 2,50



Camerino

Base in alluminio. Diffusore in vetro bianco soffiato e acidato, chiuso alle estremità da dischi in materiale acrilico trasparente.

■ IP20	■ IP20	■ IP20
1,170 Kg / 0,0157 m ³ E14 max 4 x 40W	0,960 Kg / 0,0123 m ³ E14 max 3 x 40W	0,780 Kg / 0,0097 m ³ E14 max 2 x 40W
€ 98	€ 88	€ 78
027104 Bianco	027098 Bianco	027081 Bianco
3000 K 420 lm	3000 K 420 lm	3000 K 420 lm
101217 € 2,50	101217 € 2,50	101217 € 2,50



Pretty

Base ed elementi laterali in alluminio verniciato a polveri. Diffusore cilindrico in policarbonato opale lucido. Finitura: bianco.

LED Sorgente luminosa LED 3000 K, 50.000 h di durata.

IP54 Grado di protezione IP54.

■ IP54	■ IP54	■ IP54
1,250 Kg / 0,0169 m ³ LED 24W / 2750 lm	1,120 Kg / 0,0137 m ³ LED 17W / 2200 lm	0,960 Kg / 0,0105 m ³ LED 11,5W / 1250 lm
€ 145	€ 125	€ 100
287768 Bianco	287775 Bianco	287782 Bianco





Privè

Corpo luce interamente in metallo con varie finiture. L'assenza di diffusore consente di montare una vasta gamma di lampade con attacco E14.

159423



045627



159508



179681



805

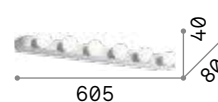

⏏ IP20

1,420 Kg / 0,0143 m³
E14 max 8x40W

€ 128

159522 ■ Bianco
045634 ■ Cromo

⏏ IP20

1,100 Kg / 0,0095 m³
E14 max 6x40W

€ 100

159423 ■ Bianco
045627 ■ Cromo
159508 ■ Nero
179681 ■ Ottone

💡 3000 K
420 lm
101217 € 2,50

💡 3000 K
420 lm
101217 € 2,50



Essence

Base e corpo luce in alluminio verniciato a polveri. Diffusore in materiale acrilico opale. Emissione luce indiretta. Colori: bianco o nero.

LED Sorgente luminosa LED 3000 K, 30.000 h di durata.



285115



285108

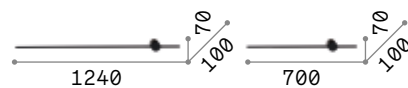

1,040 Kg / 0,0163 m³
LED 20W / 2650 lm

€ 240

265575 ■ Bianco
285108 ■ Nero



0,800 Kg / 0,0205 m³
LED 12,5W / 1650 lm

€ 182

285115 ■ Bianco
265643 ■ Nero





Filo **new**

Base e montatura in alluminio verniciato a polveri o placcato. Diffusore inclinato a 45° in policarbonato opale opaco. Finiture: bianco, nero, ottone spazzolato.

LED

Sorgente luminosa LED 3000 K, 20.000 h di durata.

IP44

Grado di protezione IP44.



310138



310145



327792

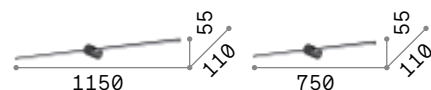

IP44

0,610 Kg / 0,0138 m³
LED 16W / 2000 lm

€ 200

IP44

0,500 Kg / 0,0093 m³
LED 12,5W / 1450 lm

€ 180

327778	■ Bianco	new	310138	■ Bianco	new
310152	■ Nero	new	310145	■ Nero	new
327785	■ Ottone	new	327792	■ Ottone	new



P. 078



P. 472



P. 530



Theo ^{new}

Base e montatura in alluminio verniciato a polveri. Diffusore in policarbonato opale lucido. Finiture: bianco, nero.

LED Sorgente luminosa LED 3000 K, 30.000 h di durata.

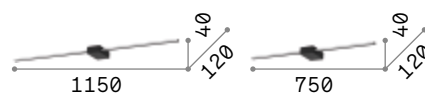
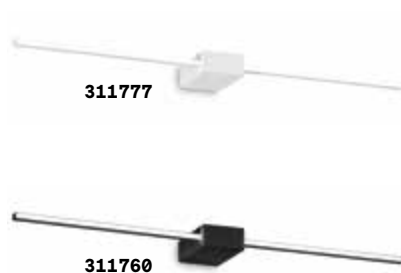

IP20

0,600 Kg / 0,0168 m³
LED 20,5W / 1250 lm

€ 130

IP20

0,520 Kg / 0,0112 m³
LED 13,5W / 870 lm

€ 115

327945 **Bianco** ^{new} 311777 **Bianco** ^{new}
311784 **Nero** ^{new} 311760 **Nero** ^{new}



Alma

Corpo luce in metallo rifinito ottone satinato, cromo o con vernice a polveri bianco. Diffusore fisso in materiale plastico colore opale.

LED Sorgente luminosa LED 3000 K, 30.000 h di durata.



■ □ IP20

0,660 Kg / 0,0264 m³
LED 18W / 2250 lm

€ 165

225029 **Bianco**
224992 **Cromo**
225005 **Ottone**

■ □ IP20

0,650 Kg / 0,0162 m³
LED 12,5W / 1450 lm

€ 125

224985 **Bianco**
224930 **Cromo**
224954 **Ottone**

Make Up

Base e corpo luce in alluminio verniciato a polveri. Diffusore in acrilico trasparente satinato. Emissione luce in basso. Finiture: bianco.

LED Sorgente luminosa LED 3000 K, 50.000 h di durata.

IP54 Grado di protezione IP54.

■ IP54	■ IP54	■ IP54
1,400 Kg / 0,0129 m³ LED 27W / 3400 lm	1,200 Kg / 0,0088 m³ LED 18W / 2300 lm	1,000 Kg / 0,0067 m³ LED 12W / 1250 lm
€ 200	€ 145	€ 120
287676 ■ Bianco	287669 ■ Bianco	287652 ■ Bianco



Riflesso ^{new}

Montatura in metallo rifinito in cromo, vernice bianca o nera opaca. Diffusore in materiale acrilico trasparente e satinato.

LED Sorgente luminosa LED 3000 K, 30.000 h di durata.

IP44 Grado di protezione IP44.

■ IP44	■ IP44
0,750 Kg / 0,0192 m³ LED 17W / 1800 lm	0,600 Kg / 0,0143 m³ LED 11W / 1100 lm
€ 190	€ 155
142289 ■ Bianco 142265 ■ Cromo 302232 ■ Nero	142296 ■ Bianco 142272 ■ Cromo 302225 ■ Nero
	new 302225 ■ Nero new



142296

142272

302225

Bow

Montatura in metallo con finitura disponibile in brunito, cromo o ottone satinato. Diffusore a LED inclinabile. Interruttore sulla base.

LED Sorgente luminosa LED 3000 K, 20.000 h di durata.

ON OFF Lampada con interruttore integrato.

■ IP20	■ IP20	■ IP20
0,860 Kg / 0,0328 m³ LED 8W / 980 lm	0,790 Kg / 0,0207 m³ LED 4,5W / 570 lm	0,640 Kg / 0,0117 m³ LED 2,5W / 360 lm
€ 195	€ 145	€ 125
007021 Cromo 121130 Ottone 121147 Brunito	007045 Cromo 121178 Ottone 121161 Brunito	005386 Cromo 121154 Ottone 121338 Brunito



Mirror-10

Montatura in metallo con finitura in brunito, cromo o nickel satinato. Diffusore posizionabile.

LED Lampadine LED G9 4W 3000 K incluse. Cod. **209043**

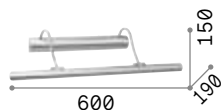

■ IP20

1,090 Kg / 0,0181 m³
G9 max 4 x 40W

€ 138

017303 Cromo
017297 Nickel
017310 Brunito

3000 K
510 lm

305486 € 6,00



Retrò

Base braccio e diffusore interamente in metallo con finitura brunito. Diffusore orientabile.

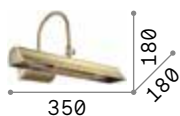

■ IP20

0,790 Kg / 0,0152 m³

E14 max 2x28W

€ 120

144917 ■ Brunito

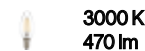

101224 € 2,50



Mirror-20

Montatura in metallo con finitura disponibile in brunito, in cromo o in ottone. Diffusore regolabile.



Lampadine LED G9 4W 3000 K incluse.
Cod. 209043

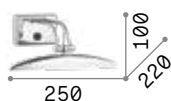

■ IP20

0,550 Kg / 0,0077 m³

G9 max 2x40W

€ 94

017334 ■ Cromo

031507 ■ Ottone

017327 ■ Brunito

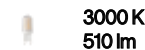

305486 € 6,00



017334



031507



017327



Focus

Corpo luce in metallo con braccio flessibile orientabile rivestito in gomma. Rifinito in bianco o in nero opaco oppure in grigio con dettagli in cromo.

LED Sorgente luminosa LED 3000 K, 20.000 h di durata.

ON OFF Lampada con interruttore integrato.



097183

097206

097190

203171

203188

203195

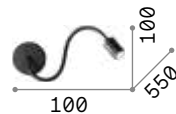

IP20

0,400 Kg / 0,0025 m³
LED 4W / 210 lm

€ 71

097183 ■ Bianco
097206 ■ Cromo
097190 ■ Nero

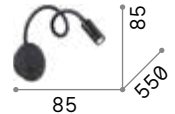

IP20

0,410 Kg / 0,0020 m³
LED 3,5W / 280 lm

€ 75

203171 ■ Bianco
203188 ■ Cromo
203195 ■ Nero



IO

Corpo luce da incasso con montatura in metallo verniciato a polveri. Braccio flessibile rivestito in gomma. Diffusore con schermo acrilico trasparente zigrinato. Interruttore incorporato. Colori: bianco o nero.

LED Sorgente luminosa LED 3000 K, 30.000 h di durata.

ON OFF Lampada con interruttore integrato.



285320



272030

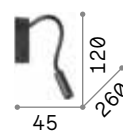

IP20

0,240 Kg / 0,0027 m³
LED 3W / 300 lm

€ 130

285320 ■ Bianco
272030 ■ Nero



Goose

Montatura e diffusore in fusione d'alluminio verniciato a polveri con colori opachi. Braccio flessibile rivestito in gomma siliconica.

LED Sorgente luminosa LED 3000 K, 30.000 h di durata.

ON OFF Lampada con interruttore integrato.



142708



142692

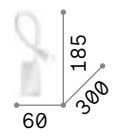

IP20

0,430 Kg / 0,0040 m³
LED 3W / 200 lm

€ 145

142708 ■ Bianco
142692 ■ Nero



Dynamo

Montatura e braccio flessibile in metallo con finitura disponibile in cromo, nickel e brunito. Diffusore orientabile a piacere. Dotato di interruttore sulla base.

LED Sorgente luminosa LED 4000 K, 20.000 h di durata.

ON/OFF Lampada con interruttore integrato.



031460



031477



121352

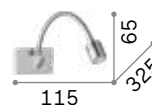

IP20

0,500 Kg / 0,0031 m³
LED 3W / 200 lm

€ 88

031460 Cromo
031477 Nickel
121352 Brunito



Bean

Base e diffusore orientabile in metallo placcato o verniciato a polveri. Colori bianco, nero oppure ottone o nickel con interruttore e snodo neri.

LED Sorgente luminosa LED 3000 K, 30.000 h di durata.

ON OFF Lampada con interruttore integrato.

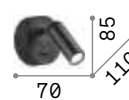

0,180 Kg / 0,0008 m³
LED 3W / 280 lm

0,180 Kg / 0,0005 m³
LED 3W / 280 lm

€ 48

€ 48

260648 Bianco
260679 Nickel
260655 Nero
260662 Ottone

260600 Bianco
260631 Nickel
260617 Nero
260624 Ottone



Page

Corpo luce in alluminio verniciato a polveri bianco o nero. Diffusore orientabile con lente e elemento snodato in metallo cromato.

LED Sorgente luminosa LED 3000 K, 30.000 h di durata.

ON OFF Lampada con interruttore integrato.

142586



142579

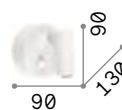

IP20

0,320 Kg / 0,0025 m³
LED 3W / 145 lm

€ 100

142586 ■ Bianco
142579 ■ Nero

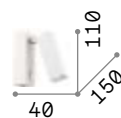

IP20

0,420 Kg / 0,0023 m³
LED 3W / 145 lm

€ 105

142258 ■ Bianco
142241 ■ Nero



Pipe

Corpo luce in alluminio verniciato a polveri. Diffusore orientabile con schermo acrilico zigrinato, fissato con ghiera. Interruttore incorporato. Colori: bianco o nero.

LED Sorgente luminosa LED 3000 K, 20.000 h di durata.

ON OFF Lampada con interruttore integrato.



280998



281001

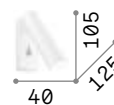

IP20

0,400 Kg / 0,0009 m³
LED 7W / 580 lm

€ 100

280998 ■ Bianco
281001 ■ Nero



ONLY BOX 502

Lite

Base e corpo luce in alluminio con finitura bianco, nero, nickel o ottone. Diffusore orientabile. Interruttore incorporato. Installazione ad incasso su scatola di derivazione tipo 502, non inclusa.

LED Sorgente luminosa LED 3000 K, 20.000 h di durata.

ON OFF Lampada con interruttore integrato.



250106



250137



250113



250120

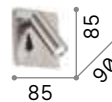

IP20

0,340 Kg / 0,0008 m³
LED 3W / 200 lm

€ 61

250106 Bianco
250137 Nickel
250113 Nero
250120 Ottone



Piano

Montatura interamente in alluminio verniciato a polveri. Diffusore in policarbonato opale con emissione sul retro. Proiettore frontale orientabile. Colore: bianco o nero.

LED Sorgente luminosa LED 3000 K, 20.000 h di durata.

ON OFF Lampada con interruttore integrato.

USB Lampada con presa USB integrata.

287317



287300

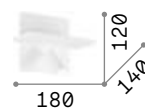

■ □ IP20

0,800 Kg / 0,0068 m³
LED 11,5W / 1200 lm

€ 165

287317 ■ Bianco
287300 ■ Nero



Komodo

Montatura in metallo verniciato a polveri. Diffusore orientabile. Interruttore e presa USB incorporati. Finiture: bianco oppure nero.

LED Sorgente luminosa LED 3000 K, 20.000 h di durata.

ON/OFF Lampada con interruttore integrato.

USB Lampada con presa USB integrata.

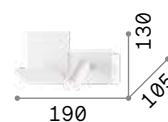
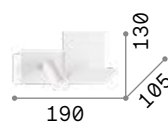

■ □ IP20

0,700 Kg / 0,0060 m³
LED 4,5W / 250 lm

€ 90

291789 ■ Bianco
291796 ■ Nero

■ □ IP20

0,700 Kg / 0,0060 m³
LED 4,5W / 250 lm

€ 90

306810 ■ Bianco
306827 ■ Nero

Probe

Corpo luce in alluminio verniciato a polveri bianco o nero. Doppio diffusore: superiore in acrilico e inferiore con braccetto flessibile.

LED Sorgente luminosa LED 3000 K, 20.000 h di durata.

ON OFF Lampada con interruttore integrato.

USB Lampada con presa USB integrata.

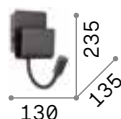

■ IP20

0,870 Kg / 0,0021 m³

LED 9W / 700 lm

€ 150

243160 ■ Bianco

237930 ■ Nero



243160

237930

Read

Montatura metallica verniciata a polveri con finitura bianca o nera. Diffusore orientabile con LED integrato. Presa USB.

LED Sorgente luminosa LED 3000 K, 15.000 h di durata.

ON OFF Lampada con interruttore integrato.

USB Lampada con presa USB integrata.

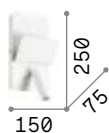

■ IP20

1,060 Kg / 0,0049 m³

LED 3W / 200 lm

€ 150

176536 ■ Bianco

176550 ■ Nero



176536

176550



Book

Montatura metallica verniciata a polveri. Diffusore in vetro satinato. Braccio flessibile gommato con LED. Doppio interruttore. Presa USB.

LED Sorgente luminosa LED 3000 K, 15.000 h di durata.

ON/OFF Lampada con interruttore integrato.

USB Lampada con presa USB integrata.



IP20

1,570 Kg / 0,0125 m³
G9 max 1x 28W +
LED 3W / 200 lm

€ 180

174792 ■ Bianco
174808 ■ Nero

3000 K
510 lm

305486 € 6,00



IP20

1,570 Kg / 0,0125 m³
G9 max 1x 28W +
LED 3W / 200 lm

€ 180

174822 ■ Bianco
174846 ■ Nero

3000 K
510 lm

305486 € 6,00

Mouse

Base, montatura e diffusori in metallo rifinito con vernice opaca e dettagli in cromo. Diffusori orientabili. Disponibile nelle finiture bianco o nero.

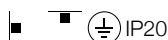
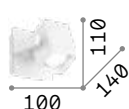

0,910 Kg / 0,0067 m³
GU10 max 2x 50W

0,450 Kg / 0,0034 m³
GU10 max 1x 50W

€ 127

€ 72

073545 Bianco
156705 Nero

073521 Bianco
073569 Nero

3000 K
410 lm
108292 € 3,00

3000 K
410 lm
108292 € 3,00

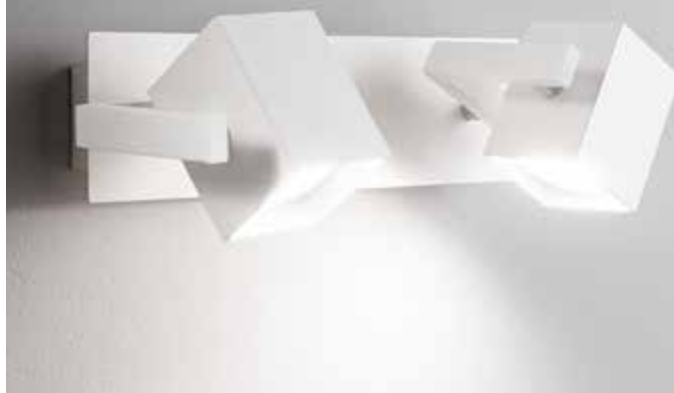

Spot

Base, montatura e diffusori in metallo rifinito con vernice opaca e dettagli in cromo. Diffusori orientabili. Disponibile nelle finiture bianco o nero.



0,610 Kg / 0,0060 m³
GU10 max 2x 50W

0,410 Kg / 0,0037 m³
GU10 max 1x 50W

€ 52

€ 32

156736 Bianco
156743 Nero

156729 Bianco
115481 Nero

3000 K
410 lm
108292 € 3,00

3000 K
410 lm
108292 € 3,00





Rudy ^{new}

Montatura in alluminio pressofuso verniciato a polveri bianco o nero. Diffusori orientabili in rotazione e inclinazione.

LED Lampadine LED GU10 7W 3000 K incluse. Cod. **123943**

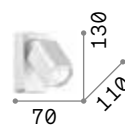
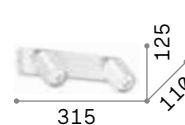
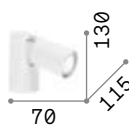
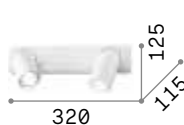

0,570 Kg / 0,0046 m³
GU10 max 2 x 35W

0,270 Kg / 0,0017 m³
GU10 max 1 x 35W

0,570 Kg / 0,0046 m³
GU10 max 2 x 35W

0,270 Kg / 0,0017 m³
GU10 max 1 x 35W

€ 100

€ 50

€ 105

€ 55

229041 ■ Bianco
229034 ■ Nero

229027 ■ Bianco
229010 ■ Nero

294803 ■ Bianco ^{new}
321509 ■ Nero ^{new}

294766 ■ Bianco ^{new}
321530 ■ Nero ^{new}

3000 K
540 lm

3000 K
540 lm

3000 K
540 lm

3000 K
540 lm

123943 € 3,50

123943 € 3,50

123943 € 3,50

123943 € 3,50



P. 326



Gim

Montatura in alluminio verniciato a polveri. Diffusore ruotabile con schermo acrilico satinato. Interruttore incorporato. LED integrati.

LED

Sorgente luminosa LED 3000 K, 15.000 h di durata.

**ON
OFF**

Lampada con interruttore integrato.



167152



167121

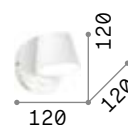

■  IP20

0,450 Kg / 0,0034 m³
LED 6W / 530 lm

€ 80

167152 ■ Bianco
167121 ■ Nero



Dodo **new**

Base e corpo luce in metallo verniciato a polveri o placcato. Diffusore orientabile con sorgente a led sostituibile. Finiture: bianco, nero, ottone spazzolato.

LED

Lampadine LED GX53 9W 3000 K incluse. Cod. **123936**

314105



314099



314129

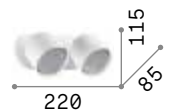

IP20

0,930 Kg / 0,0035 m³
GX53 max 2x 15W

€ 68

314136 **Bianco** **new**
327938 **Nero** **new**
327921 **Ottone** **new**

3000 K
910 lm

123936 € 5,50



IP20

0,450 Kg / 0,0015 m³
GX53 max 1x 15W

€ 36

314105 **Bianco** **new**
314099 **Nero** **new**
314129 **Ottone** **new**

3000 K
910 lm

123936 € 5,50

Oby

Montatura in metallo verniciato bianco opaco, con snodi cromati. Corpo luce orientabile con diffusore in materiale plastico bianco.

LED Sorgente luminosa LED 3000 K, 20.000 h di durata.

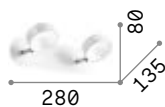

■ ■ IP20

0,620 Kg / 0,0030 m³
LED 12W / 1400 lm

€ 120

196695 ■ Bianco



■ ■ IP20

0,310 Kg / 0,0020 m³
LED 6W / 700 lm

€ 61

196688 ■ Bianco



P. 325

Barber

Base, snodo e copri portalampade interamente in metallo. Corpo luce inclinabile. Disponibile nella versione brunito.

LED Lampadine LED GU10 7W 3000 K incluse. Cod. **123943**

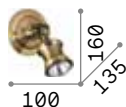

■ ■ IP20

0,230 Kg / 0,0025 m³
GU10 max 1x28W

€ 75

159997 ■ Brunito

3000 K
540 lm

123943 € 3,50



Alfa

Montatura in metallo con finitura in brunito, bianco satinato o nickel satinato. Corpo luce posizionabile con rotazione dello stelo e snodo per l'inclinazione.

LED Lampadine LED GU10 7W 3000 K incluse. Cod. **123943**

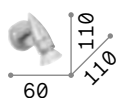
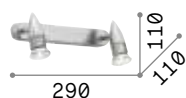

0,390 Kg / 0,0031 m³
GU10 max 2x 50W

0,170 Kg / 0,0010 m³
GU10 max 1x 50W

€ 45

€ 23

122717 **Bianco**
009483 **Nickel**

099057 **Bianco**
009377 **Nickel**
119786 **Brunito**

3000 K
540 lm
123943 € 3,50

3000 K
540 lm
123943 € 3,50



P. 330



099057



009377



119786

Slem

Montatura in metallo con finitura in bianco, cromo o nickel satinato. Corpo luce posizionabile con rotazione dello stelo e snodo per l'inclinazione.

LED Lampadine LED GU10 7W 3000 K incluse. Cod. **123943**

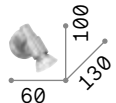
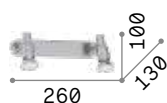

0,400 Kg / 0,0025 m³
GU10 max 2x 50W

0,200 Kg / 0,0010 m³
GU10 max 1x 50W

€ 45

€ 23

142081 **Bianco**
142050 **Cromo**
018836 **Nickel**

099064 **Bianco**
122984 **Cromo**
018829 **Nickel**

3000 K
540 lm
123943 € 3,50

3000 K
540 lm
123943 € 3,50



P. 330



099064



122984



018829

Winery

Corpo luce con portalampane incorporato interamente in ceramica smaltata bianca o nera. Modello AP con assetto inclinato verso il basso.

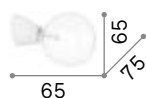

0,250 Kg / 0,0004 m³
E27 max 1x60W

€ 27

180298 ■ Bianco
180304 ■ Nero

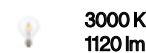

101323 € 7,00 [P. 323](#)



180298

180304

Edison

Montatura in metallo rifinito con vernice opaca bianca o nera. Cavo elettrico in tessuto. Diffusore orientabile.

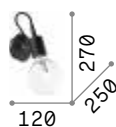

0,410 Kg / 0,0134 m³
E27 max 1x60W

€ 62

138374 ■ Bianco
148908 ■ Nero

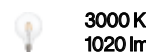

101347 € 8,00 [P. 115](#)



138374

148908



Radio

Rosone e montatura in metallo. Diffusore posizionabile. Cavo elettrico in tessuto. Disponibile con finitura in cromo o con vernice opaca bianca o nera.

LED

Lampadine LED E27 8W Globo D125 trasparente 3000 K incluse.
Cod. **101347**

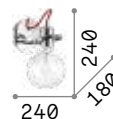

IP20

0,450 Kg / 0,0119 m³
E27 max 1x60W

€ 72

119465 Bianco
119427 Cromo
119502 Nero

 3000 K
1020 lm

101347 € 8,00



Minimal

Montatura in metallo rifinito in smalto colorato. Cavo elettrico con rivestimento in tessuto.

LED

Lampadine LED E27 8W Globo D125 trasparente 3000 K incluse.
Cod. **101347**

045191



045214

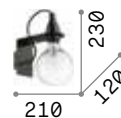

IP20 

0,720 Kg / 0,0164 m³
E27 max 1x60W

€ 77

045191 ■ Bianco
045214 ■ Nero

 3000 K
1020 lm

101347 € 8,00



P. 116



Frida

Montatura e copri porta lampade in metallo con finiture brunito e rame. Cavo in tessuto nero.



IP20

0,430 Kg / 0,0092 m³
E27 max 1x 60W

€ 47

163338 ■ Rame
163321 ■ Brunito

2200 K
500 lm

151717 € 8,00





Igor

Montatura in metallo rifinito con vernice opaca nera. Diffusore con lastre di vetro trasparente.

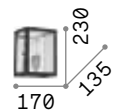

■  IP20

1,590 Kg / 0,0136 m³
E27 max 1x60W

€ 95

092836 ■ Nero

 2200 K
440 lm

151694 € 6,00



P. 095



Birds

Montatura in metallo verniciato con disco decorativo in ottone satinato. Diffusori in vetro soffiato bianco acidato. Colore: nero opaco con dettaglio ottone satinato.

LED

Lampadine LED G9 4W 3000 K incluse.
Cod. **209043**

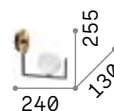

IP20 INCLUSA

0,670 Kg / 0,0192 m³
G9 max 1x 15W

€ 73

273655 ■ Nero

3000 K
510 lm

305486

€ 6,00



P.099



P.337



P.494



P.522



Kepler

Montatura in metallo verniciato
nero opaco. Diffusori in vetro
soffiato trasparente ambrato.



■ □ IP20

0,900 Kg / 0,0428 m³
E27 max 3 x 60W

€ 150

187006 ■ Nero

3000 K
430 lm

101279 € 2,60



P. 105



Perlage ^{new}

Montatura in metallo. Finiture: nero opaco con vetri pirex fumé o ottone satinato con vetri bianchi acidati.

LED Lampadine LED G9 4W 3000 K incluse.
Cod. **209043**

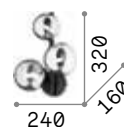

0,800 Kg / 0,0173 m³
G9 max 3 x 15W

€ 150

283784 ■ Bianco
271439 ■ Fumè
322742 ■ Ambra ^{new}

3000 K
510 lm

305486 € 6,00

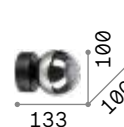

0,400 Kg / 0,0062 m³
G9 max 1 x 15W

€ 65

292410 ■ Bianco
292403 ■ Fumè
317809 ■ Ambra ^{new}

3000 K
510 lm

305486 € 6,00



P. 100 P. 334 P. 495 P. 524

Triumph

Montatura interamente in metallo con finitura nero o ottone invecchiato. Modelli AP con cavo in tessuto con interruttore e spina.

ON
OFF Lampada con interruttore integrato.

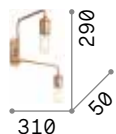

■ □ IP20

0,710 Kg / 0,0067 m³
E27 max 2 x 60W

€ 160

242385 ■ Nero
160245 ■ Ottone

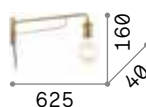

■ □ IP20

0,490 Kg / 0,0083 m³
E27 max 1 x 60W

€ 105

242392 ■ Nero
160214 ■ Ottone

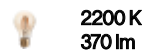

151687 € 4,60

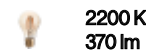

151687 € 4,60



P. 092



P. 336



Maracas

Montatura interamente in metallo rifinito in ottone satinato. Diffusori orientabili in vetro soffiato trasparente.

LED Lampadine LED G4 2W 3000 K incluse.
Cod. 222257

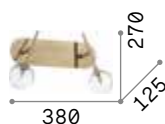

■ □ IP20

0,550 Kg / 0,0049 m³
G4 max 2 x 2W

€ 138

200347 ■ Ottone

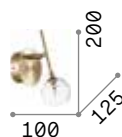

■ □ IP20

0,280 Kg / 0,0034 m³
G4 max 1 x 2W

€ 72

200330 ■ Ottone

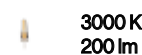

222257 € 4,00

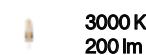

222257 € 4,00



P. 331





Equinoxe

Montatura a bracci in metallo con finitura cromo o ottone antico. Diffusori in vetro soffiato trasparente.

LED Lampadine LED G4 2W 3000 K incluse.
Cod. 222257



200149



200132

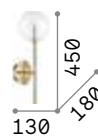

IP20

0,990 Kg / 0,0243 m³
G4 max 1x2W

€ 131

200132 Cromo
200149 Ottone

3000 K
200 lm

222257 € 4,00



P. 102



P. 525

Cantina

Montatura, diffusore e copriportalampada in metallo disponibile con finitura brunito o rame. Cavo in tessuto.

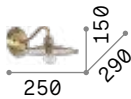

■  IP20

0,520 Kg / 0,0184 m³

E14 max 1x40W

€ 85

112695 ■ Rame

112626 ■ Brunito



3000 K
480 lm



101200 € 2,50 [P. 133](#)



112695

112626

Newton

Montatura e diffusore in metallo. Disponibile con finitura in nickel satinato, brunito o con vernice nera opaca. Braccio regolabile. Diffusore orientabile smaltato bianco all'interno.

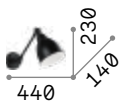

■  IP20

0,600 Kg / 0,0093 m³

E27 max 1x42W

€ 62

016399 ■ Nickel

027852 ■ Nero

027876 ■ Brunito



3000 K
900 lm



123899 € 6,00 [P. 542](#)



016399

027852

027876



Shower

Montatura in metallo verniciato opaco nero. Elemento snodato in cromo. Diffusore orientabile. Cavo in tessuto con interruttore e spina.



Lampada con interruttore integrato.



IP20

0,760 Kg / 0,0391 m³
E27 max 1x60W

€ 130

179643 ■ Nero

3000 K
900 lm

123899 € 6,00



Ping Pong new

Montatura in metallo rifinito con vernice a polveri. Diffusori con sfere in acrilico trasparente satinato. Driver integrato. Finiture: bianco, nero, ottone spazzolato.



LED Sorgente luminosa LED 3000 K, 50.000 h di durata.

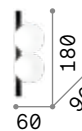

IP20

0,540 Kg / 0,0021m³
LED 6W / 500 lm

€ 90

328270 ■ Bianco new
313252 ■ Nero new
328287 ■ Ottone new

  
P. 348 P. 488 P. 533



Binomio new

Montatura in metallo. Diffusori in vetro soffiato bianco acidato con fissaggio a vite. Finiture: bianco, nero, ottone spazzolato.



Lampadine LED G9 4W 3000 K incluse.
Cod. **209043**

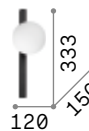

0,500 Kg / 0,0081 m³
G9 max 1x 4W

€ 50

328478 ■ Bianco new
310664 ■ Nero new
311319 ■ Ottone new

3000 K
510 lm
305486 € 6,00



P. 349



Pan

Diffusore con tubi decorativi di diverse misure in metallo placcato. Emissione luce sopra e sotto.

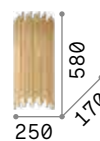

■  IP20

6,340 Kg / 0,0461 m³
E14 max 2x 40W

€ 400

208794  Oro

 3000 K
470 lm

101224 € 2,50



P. 192

Penta new

Montatura in metallo. Diffusori in vetro soffiato bianco acidato con fissaggio a vite. Finiture: oro spazzolato.

LED Lampadine LED G9 4W 3000 K incluse.
Cod. **209043**

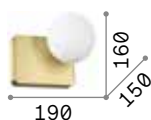

IP20

0,600 Kg / 0,0060 m³

G9 max 1x 4W

€ 58

314334 **Oro** new

3000 K
510 lm

305486 € 6,00 P. 352



Ninfea

Base in metallo verniciato a polveri o placcato. Diffusori in vetro incamiciato bianco, soffiato e acidato. Finiture: bianco oppure ottone satinato.

LED Lampadine LED GX53 9W 3000 K incluse. Cod. **123936**

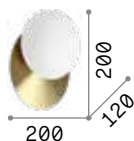

IP20

0,800 Kg / 0,0084 m³

GX53 max 1x 15W

€ 95

306940 **Bianco**

293646 **Ottone**

3000 K
910 lm

123936 € 5,50 P. 351





Tick

Corpo luce in metallo verniciato a polveri bianco o rifinito in foglia oro o argento. Diffusore inclinabile di 90°.

LED Sorgente luminosa LED 3000 K, 30.000 h di durata.



238951



238975



238944

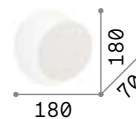

■ □ IP20

0,440 Kg / 0,0029 m³
LED 7,5W / 700 lm

€ 65

238975 ■ Bianco
238951 ■ Argento
238944 ■ Oro

Sunrise

Corpo luce interamente in metallo rifinito con vernice opaca nera, interno in foglia oro.

LED Lampadine LED G9 4W 3000 K incluse.
Cod. 209043

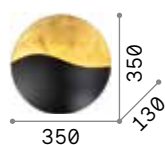

1,290 Kg / 0,0362 m³
G9 max 4 x 40W

€ 225

133300 ■ Nero

305486 3000 K
510 lm € 6,00

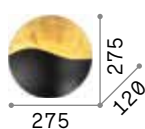

0,850 Kg / 0,0224 m³
G9 max 3 x 40W

€ 195

133270 ■ Nero

305486 3000 K
510 lm € 6,00

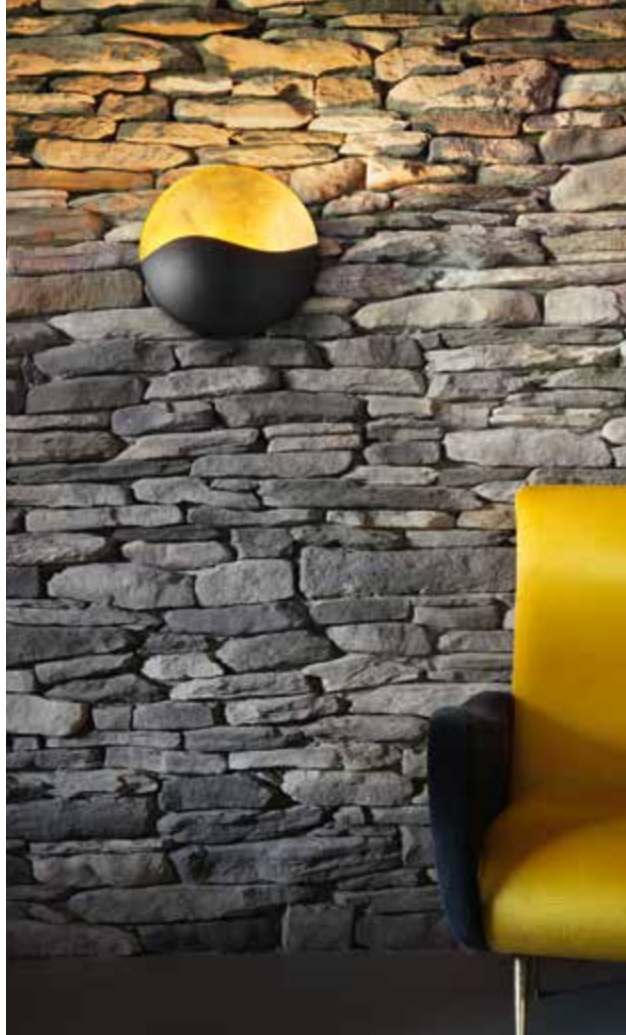

Eclissi

Montatura in metallo rifinito con vernice a polveri e foglia oro.
Il posizionamento variabile del diffusore superiore, consente una rifrazione luminosa più bianca o più dorata.

LED Sorgente luminosa LED 3000 K,
17.500 h di durata.

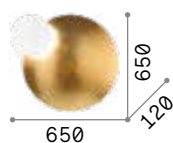

5,600 Kg / 0,0615 m³
LED 30W / 2250 lm

€ 380

259062 ■ Oro

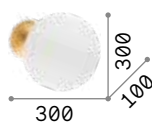

1,400 Kg / 0,0131 m³
LED 11W / 950 lm

€ 115

259048 ■ Oro

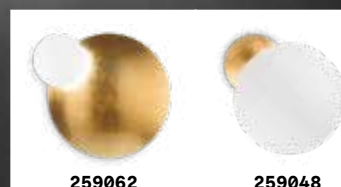

259062

259048



P. 196 P. 302 P. 504 P. 558

Set up

Montature in metallo verniciato a polveri o placcato. Applique a due luci con braccio flessibile rivestito in gomma, interruttori indipendenti e presa USB. Paralumi in pvc ignifugo rivestito di tessuto. Colori montature: bianco, nero oppure nichel satinato o ottone spazzolato con dettagli neri. Colori paralumi: beige, tortora, bianco o nero.



LED

Sorgente luminosa LED 3000 K nel modello **259819, 259826, 259833** e **259857**, 20.000 h di durata.

**ON
OFF**

Lampada con interruttore integrato nei modelli: **259819, 259826, 259833** e **259857**.

USB

Lampada con presa USB integrata nei modelli: **259819, 259826, 259833** e **259857**.

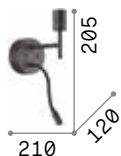

IP20

0,900 Kg / 0,0063 m³
E27 max 1x60W +
LED 3W / 200 lm

€ 115

259819 Bianco
259833 Nickel
259826 Nero
259857 Ottone

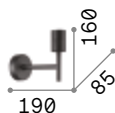

IP20

0,370 Kg / 0,0032 m³
E27 max 1x60W

€ 55

259765 Bianco
259796 Nickel
259772 Nero
259802 Ottone

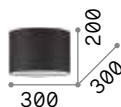

0,023 Kg / 0,0238 m³

€ 55

260433 Bianco
304618 Tortora
270005 Nero
260440 Beige

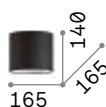

0,012 Kg / 0,0180 m³

€ 28

260327 Bianco
304601 Tortora
269986 Nero
260334 Beige

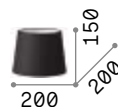

0,013 Kg / 0,0180 m³

€ 29

260068 Bianco
304113 Tortora
260075 Nero
260082 Beige

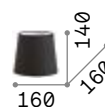

0,011 Kg / 0,0180 m³

€ 25

260341 Bianco
293004 Tortora
270036 Nero
260358 Beige

3000 K
900 lm
123899 € 6,00

3000 K
900 lm
123899 € 6,00



Hilton

Montatura in cromo. Paralume in lamina di PVC rivestita in tessuto bianco, chiuso da vetro trasparente acidato.



Lampadine LED G9 4W 3000 K incluse.
Cod. **209043**

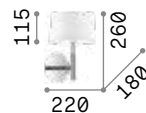

IP20 max

0,700 Kg / 0,0105 m³
G9 max 1x40W

€ 78

075471 Bianco

3000 K
510 lm

305486 € 6,00



P. 195



P. 501



P. 563



Woody

Montatura in metallo cromato.
Diffusore in PVC o in tessuto.



Lampadine LED G9 4W 3000 K incluse.
Cod. **209043**



143156



087665

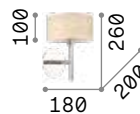

0,460 Kg / 0,0100 m³
G9 max 1x 40W

€ 70

143156 **Bianco**
087665 **Legno**

3000 K
510 lm

305486 **€ 6,00**



P. 194



P. 304

Luxury

Montatura in metallo rifinita in ottone. Base nera opaca. Paralume in pvc con bordi in tessuto.

IP20

1,220 Kg / 0,0371 m³
E27 max 1x60W

€ 247

201092 ■ Ottone

3000 K
910 lm

119571 € 6,00

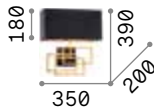

P. 500



P. 561



Nordik

Montatura in metallo verniciato nero opaco. Interruttore unico con controllo indipendente delle due sorgenti luminose.

LED Sorgente luminosa LED 3000 K, 20.000 h di durata.

IP20

0,630 Kg / 0,0156 m³
E14 max 1x40W +
LED 1,5W/100 lm

€ 110

158242 ■ Nero

3000 K
480 lm

101200 € 2,50

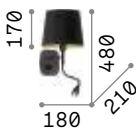

P. 192



P. 500



P. 560



Holiday

Montatura in metallo verniciato opaco. Interruttore unico con controllo indipendente delle due sorgenti luminose.

LED Sorgente luminosa LED 3000 K, 20.000 h di durata.

IP20

0,640 Kg / 0,0111 m³
E14 max 1x40W +
LED 1,5W/55 lm

€ 115

124162 ■ Bianco

124179 ■ Nero

3000 K
420 lm

101217 € 2,50

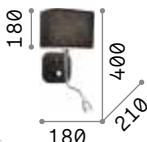

124162



124179





Hotel

Paralume rivestito in tessuto.
Diffusori in vetro satinato. Modello
AP2 con LED esterno orientabile e
interruttore indipendente.

LED

Sorgente luminosa LED 3000 K nel
modello **215693**, **035949**, **103204**,
215709 e **035956**, 20.000 h di durata.

**ON
OFF**

Lampada con interruttore integrato
nei modelli: **215693**, **035949**, **103204**,
215709 e **035956**.

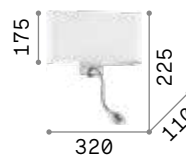

IP20

1,410 Kg / 0,0166 m³
E27 max 1x60W +
LED 1,5W / 55 lm

€ 115

215693 Total White
035949 Bianco
215709 Total Black
035956 Nero
103204 Canvas

3000 K
900 lm
123899 € 6,00

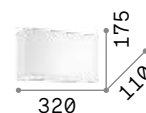

IP20

1,230 Kg / 0,0166 m³
E27 max 1x60W

€ 85

152851 Bianco

3000 K
900 lm
123899 € 6,00

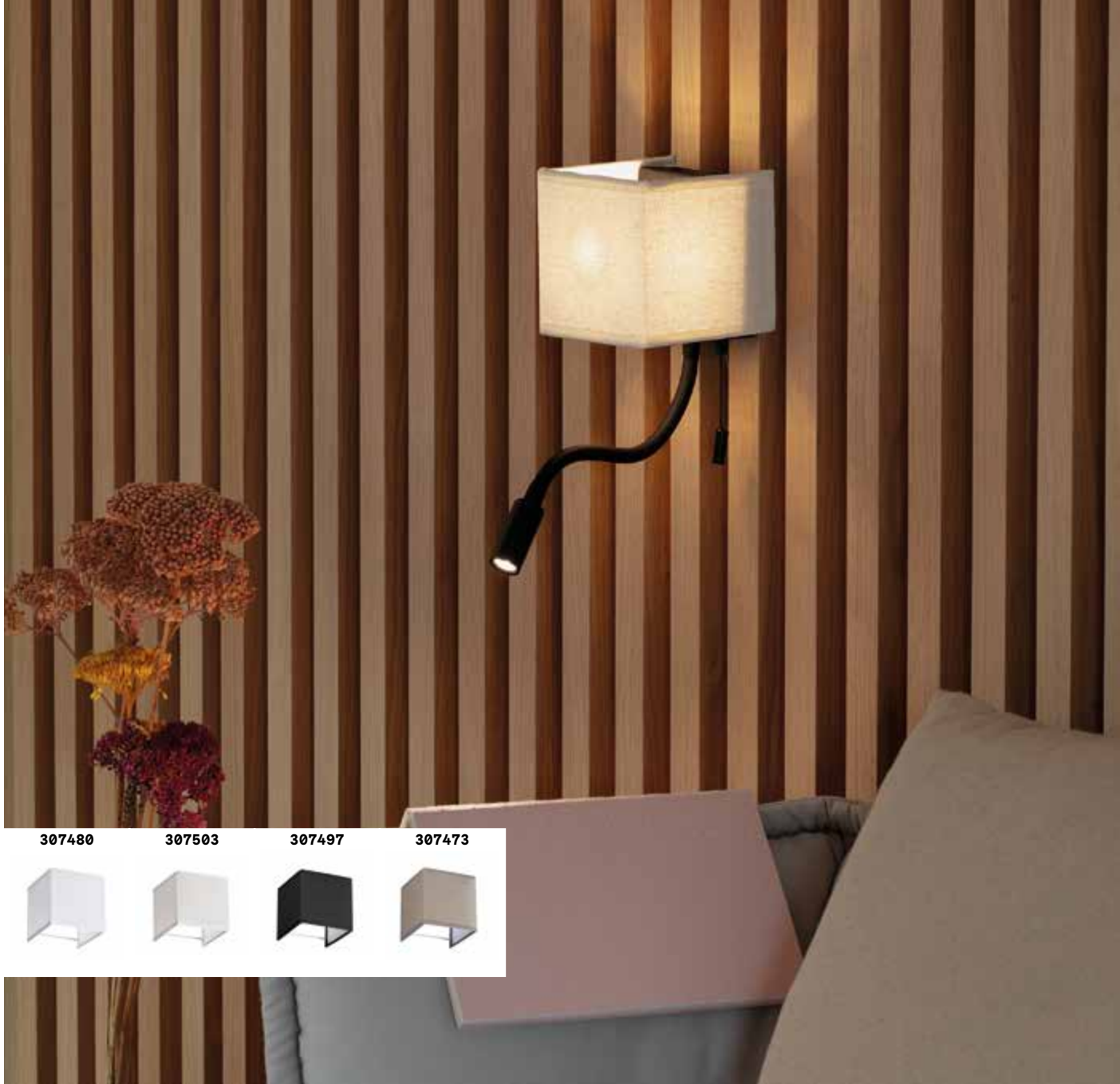

307480 307503 307497 307473



Kid new

Base in metallo verniciato a polveri.
Diffusore in pvc con tessuto.
Pres a USB. Versione a due luci
con flessibile rivestito in gomma
e interruttore integrato. Finiture
base: bianco, nero. Colori paralume:
beige, bianco, nero, tortora.



LED

Sorgente luminosa LED 3000 K nel
modello **321578** e **307466**, 50.000 h
di durata.

**ON
OFF**

Lampada con interruttore integrato nei
modelli: **321578** e **307466**.

USB

Lampada con presa USB integrata.

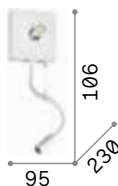

0,350 Kg / 0,0017 m³
G9 max 1x28W +
LED 3W / 160 lm

€ 75

321578 ■ Bianco
307466 ■ Nero

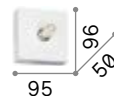

0,220 Kg / 0,0008 m³
G9 max 1x28W

€ 42

new **307459** ■ Bianco
new **307442** ■ Nero

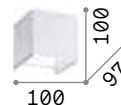

0,070 Kg / 0,0017 m³

€ 11

new **307480** ■ Bianco new
new **307503** ■ Tortora new
307497 ■ Nero new
307473 ■ Beige new

3000 K
510 lm

305486 € 6,00

3000 K
510 lm

305486 € 6,00



Gea

Corpo luce in alluminio verniciato a polveri bianco o nero. Diffusore con led integrato orientabile. Paralume in pvc rivestito di tessuto. Presa USB. Interruttori indipendenti.

LED Sorgente luminosa LED 3000 K, 20.000 h di durata.

ON/OFF Lampada con interruttore integrato.

USB Lampada con presa USB integrata.



239576



239613



239590



239606



IP20

0,500 Kg / 0,0022 m³
E27 max 1x60W +
LED 3W / 200 lm

€ 125

239521 ■ Bianco
239545 ■ Nero

3000 K
900 lm
123899 € 6,00

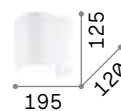

0,140 Kg / 0,0180 m³

€ 17

239576 ■ Bianco
239613 ■ Grigio
239590 ■ Nero
239606 ■ Canvas

Calypso

Montatura in metallo con finitura cromo. Elementi decorativi quadrati in cristallo molato.

LED Lampadine LED G9 4W 3000 K incluse.
Cod. **209043**

IP20

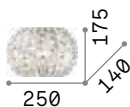

1,420 Kg / 0,0125 m³
G9 max 2x40W

€ 160

044163 Cromo

3000 K / 510 Lm
305486 € 6,00



P. 200



Roma

Montatura e dettagli in metallo cromato. Diffusore con elementi quadrati in cristallo molato sulla fascia laterale e vetro sabbiato sul fondo.

LED Lampadine LED G9 4W 3000 K incluse.
Cod. **209043**

IP20

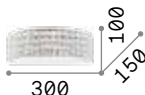

1,200 Kg / 0,0147 m³
G9 max 2x40W

€ 160

093086 Cromo

3000 K / 510 Lm
305486 € 6,00



P. 205



P. 356



P. 510



Pashà

Montatura in metallo. Diffusore composto da filari di perle in cristallo molato.

LED Lampadine LED G9 4W 3000 K incluse.
Cod. **209043**

IP20



1,110 Kg / 0,0057 m³
G9 max 3x40W

€ 210

082264 Cromo
082288 Oro

3000 K / 510 Lm
305486 € 6,00



P. 207



P. 357



082264



082288



Carlton

Montatura in metallo cromato o dorato. Elementi decorativi con catene di ottagoni e barre in cristallo molato trasparente.

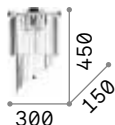

IP20

2,570 Kg / 0,0154 m³

E14 max 3x 40W

€ 170

168913 Cromo

213491 Oro



3000 K
470 lm

101224

€ 2,50



P. 204



P. 367



168913



213491

Dubai

Montatura in metallo con finitura cromo o ottone. Elementi decorativi con perle, ottagoni e prismi in cristallo molato trasparente.

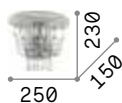

IP20

1,190 Kg / 0,0084 m³

E14 max 2x 28W

€ 210

207155 Cromo

201023 Ottone



3000 K
470 lm

101224

€ 2,50



P. 210



P. 365



207155



201023

Opera

Montatura in cromo. Paralume in lamina di PVC con riflessi metallizzati e rivestita da fili. Pendagli in cristallo molato.

LED Sorgente luminosa LED 3000 K, 15.000 h di durata.

ON OFF Lampada con interruttore integrato.

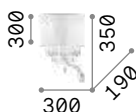

IP20

1,550 Kg / 0,0220 m³

E14 max 1x40W +
LED 1,5W / 55 Lm

€ 180

068268 Bianco

3000 K
420 Lm



101217

€ 2,50

[P. 198](#)

[P. 511](#)

[P. 565](#)

Swan

Montatura in cromo. Corpo luce in vetro soffiato e lavorato a mano. Elementi decorativi in cristallo molato. Paralume in tessuto d'organza plissettato.

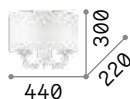

IP20

2,470 Kg / 0,0517 m³

E14 max 2x40W

€ 210

035864 Bianco

3000 K
420 Lm



101217

€ 2,50

[P. 199](#)



Pegaso

Montatura in metallo cromato oppure ottone satinato. Corpo centrale, bobeches e pendagli in cristallo molato. Paralumi in organza.

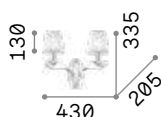

IP20

1,600 Kg / 0,0302 m³

E14 max 2 x 28W

€ 165

059211 Bianco

197708 Ottone

3000 K
370 lm

101231 € 2,50



P. 214



P. 515



P. 566



Corte

Montatura completamente in metallo modellato con lavorazione artigianale. Finitura dipinta a mano con effetto antichizzato. Disponibile nella versione bianca o ruggine.

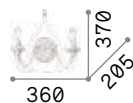

IP20

1,060 Kg / 0,0329 m³

E14 max 2 x 40W

€ 85

028460 Bianco

057200 Ruggine

3000 K
470 lm

101224 € 2,50



P. 217



Negresco

Montatura in metallo con finitura in cromo o dorata. Bracci soffiato trasparente con interno dorato nella versione oro. Centrale composto da blocchi di cristallo molato. Elementi decorativi in vetro trasparente e cristallo molato.

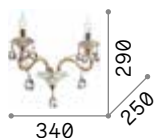

■  IP20

2,380 Kg / 0,0189 m³

E14 max 2x28W

€ 160

141046  Trasparen.

087757  Oro

 3000 K
430 lm

101248

€ 2,50

 P. 220



141046



087757

Florian

Montatura in metallo con elementi decorativi in vetro. Pendagli con ottagoni e gocce finali in cristallo molato. Disponibile nelle versioni con vetro trasparente e metallo dorato o cromato.

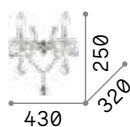

■  IP20

1,430 Kg / 0,0189 m³

E14 max 2x40W

€ 155

035642  Cromo

035659  Oro

 3000 K
470 lm

101224

€ 2,50

 P. 224



035642



035659

Gioconda

Corpo luce in fusione di metallo con finitura oro o argento antico. Pendagli ottagonali e tondi in cristallo molato.

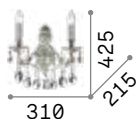

IP20

1,310 Kg / 0,0111 m³

E14 max 2 x 40W

€ 215

044910 Argento

060491 Oro



3000 K
470 lm



101224

€ 2,50

P. 228



044910



060491

Strauss

Montatura e dettagli in metallo con finitura oro rosa. Bracci in vetro soffiato trasparente. Elementi decorativi in cristallo ambrato.

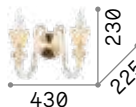

IP20

2,080 Kg / 0,0431 m³

E14 max 2 x 40W

€ 145

140599 Oro



3000 K
430 lm



101248

€ 2,50

P. 229

Firenze

Corpo luce in resina. Bracci e foglie in metallo modellato artigianalmente. Decorato a mano con foglia d'oro e antichizzato.

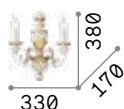

■  IP20

2,050 Kg / 0,0405 m³

E14 max 2x40W

€ 158

012902  Bianco

020846  Oro

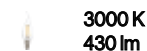

101248

€ 2,50



P. 236

P. 509

P. 567



012902



020846

Chalet

Montatura con struttura portante in metallo. Elementi decorativi in resina lavorata artigianalmente e dipinta a mano come fedele riproduzione di corna e legno intagliato.

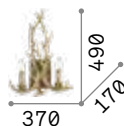

■  IP20

1,770 Kg / 0,0759 m³

E14 max 2x40W

€ 205

115511  Beige

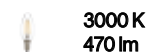

101224

€ 2,50



P. 240

P. 508





Peter

Montatura in resina lavorata artigianalmente come fedele riproduzione del legno intagliato. Paralume in lamina di PVC rivestito in tessuto canvas.

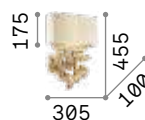

IP20

4,160 Kg / 0,0371 m³
E14 max 2 x 40W

€ 230

075211 Canvas

3000 K
480 lm

101200 € 2,50



Harem

Montatura in metallo brunito con decori in rilievo e cristalli incastonati. Diffusore in vetro soffiato leggermente ambrato. Pendaglio a nappa.

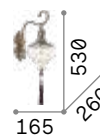

■ □ IP20

0,900 Kg / 0,0273 m³
E27 max 1x42W

€ 200

115962 ■ Brunito

● 3000 K
910 lm

119571 € 6,00



P. 239



Santa

Lampadario in vetro trasparente soffiato e lavorato a mano. Dettagli in metallo cromato. Versione oro disponibile con graniglia sul vetro.



087368



087375

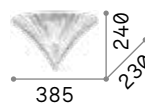

IP20

2,900 Kg / 0,0380 m³
E14 max 1x 40W

€ 230

087368 Trasparen.
087375 Oro

3000 K
470 lm

101224 € 2,50

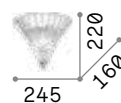

IP20

1,200 Kg / 0,0184 m³
E14 max 1x 40W

€ 100

013060 Trasparen.
013046 Oro

3000 K
470 lm

101224 € 2,50



Interni

Lampade da tavolo

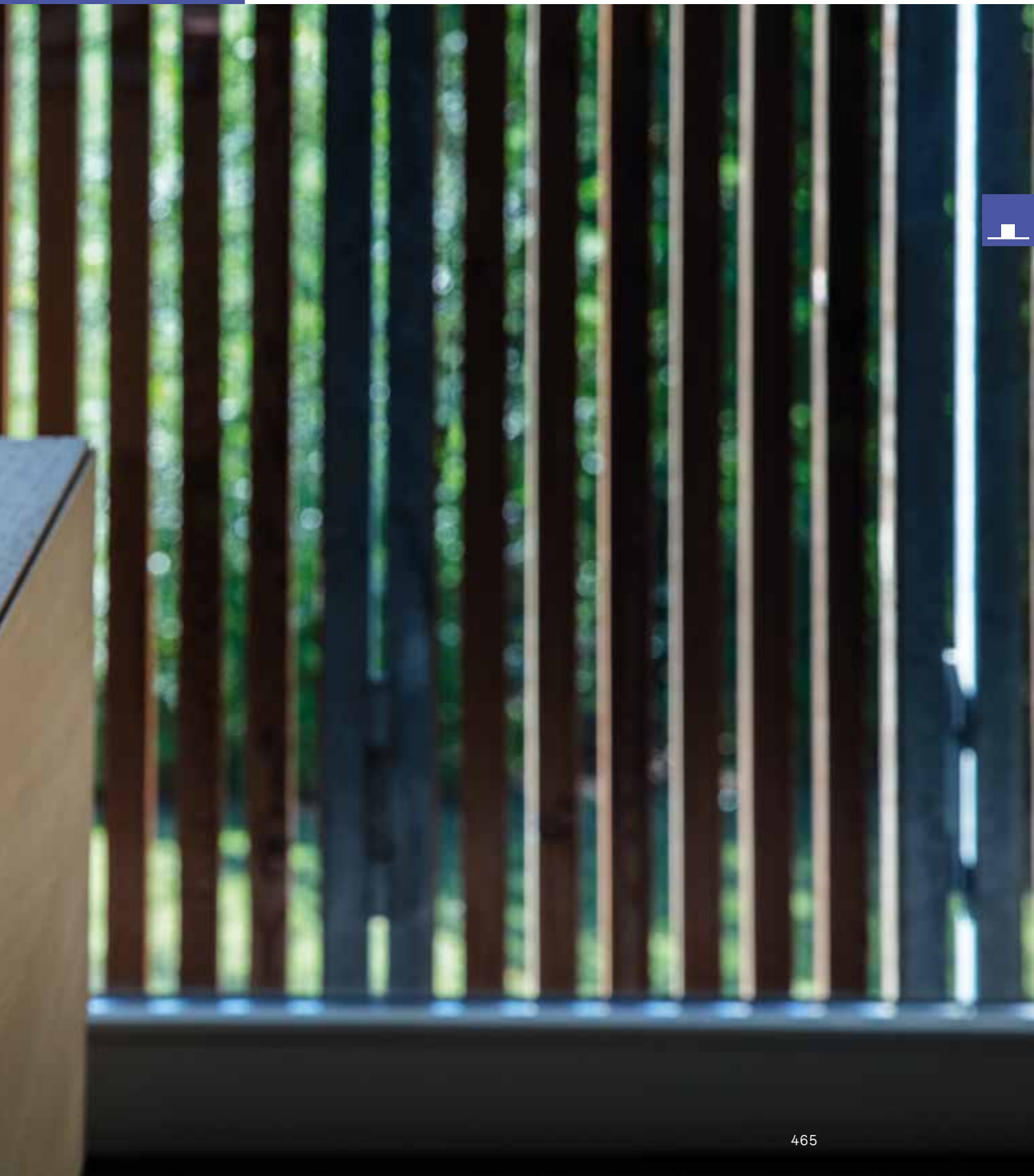

Lumiere

















































Pag 482

Indice alfabetico

Alfiere	502	Nordik	500
Angolo	496	Opera	511
Axel	498	Oz	468
Birds	494	Pegaso	515
Birillo	491	Perlage	495
Candy	486	Ping Pong	488
Carta	484	Pivot	471
Chalet	508	Prato	492
Cream	490	Queen	514
Diamond	483	Roma	510
Diesis	475	Sally	479
Driftwood	506	Set Up	504
Duchessa	513	Smarties	485
Easy	474	Snell	507
Edo	493	Truman	480
Filo	472	Wally	479
Firenze	509	Yoko	473
Futura	476		
Gru	470		
Hilton	501		
Johnny	480		
Kali	503		
Kate	512		
Kelly	478		
Lawyer	481		
Le Roy	514		
Lingotto	497		
London	499		
Lumiere	482		
Luxury	500		
Mapa Bianco	487		

Interni

Indice icone

			new 		new 	
Oz 468	Gru 470	Pivot 471	Filo 472	Yoko 473	Easy 474	Diesis 475
				new 		
Futura 476	Kelly 478	Sally 479	Wally 479	Johnny 480	Truman 480	Lawyer 481
new 	new 	new 	new 		new 	new 
Lumiere 482	Diamond 483	Carta 484	Smarties 485	Candy 486	MapaBianco 487	Ping Pong 488
new 					new 	
Cream 490	Birillo 491	Prato 492	Edo 493	Birds 494	Perlage 495	Angolo 496
						
Lingotto 497	Axel 498	London 499	Luxury 500	Nordik 500	Hilton 501	Alfiere 502
						
Kali 503	Set Up 504	Driftwood 506	Snell 507	Chalet 508	Firenze 509	Roma 510
						
Opera 511	Kate 512	Duchessa 513	Queen 514	Le Roy 514	Pegaso 515	



Oz

Base e montatura in metallo verniciato a polveri o placcato. Cavi in pvc. Diffusore in gomma opale. Disponibile nelle finiture bianco, nero o ottone spazzolato.

LED Sorgente luminosa LED 3000 K, 30.000 h di durata.

ON
OFF Lampada con interruttore integrato.

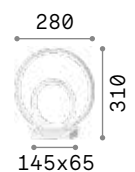

IP20

0,890 Kg / 0,0096 m³
LED 23W / 2300 lm

€ 190

269474 ■ Bianco
269481 ■ Nero
269498 ■ Ottone



Gru

Montatura interamente in metallo. Asta con finitura in cromo. Base e diffusore con finitura in vernice opaca bianca o nera. Diffusore ruotabile e regolabile in altezza.

LED Sorgente luminosa LED 3000 K, 15.000 h di durata.

ON OFF Lampada con interruttore integrato.



147642



147659

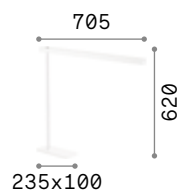

235x100

IP20

2,220 Kg / 0,0084 m³
LED 6,3W / 400 lm

€ 185

147642 ■ Bianco
147659 ■ Nero



Pivot

Montatura in alluminio verniciato opaco. Base rivestita in plastica con dimmer. Diffusore orientabile con schermo in PC opale satinato. Cavo in PVC con driver e spina.

LED Sorgente luminosa LED. CCT regolabile: 3000, 4000, 6000 K. 25.000 h di durata.

ON/OFF Lampada con interruttore integrato.

+ Lampada con dimmer.

Hand icon Lampada con dimmer tattile.



0,700 Kg / 0,0135 m³
LED 7,5W / 700 lm

€ 75

289168 ■ Bianco
289151 ■ Nero



Filo **new**

Base in metallo, corpo luce in alluminio verniciati a polvere o placcati. Diffusore in policarbonato opale opaco. Cavo in pvc con interruttore e driver integrato nella spina. Finiture: bianco, nero, ottone spazzolato.

LED Sorgente luminosa LED 3000 K, 20.000 h di durata.

ON OFF Lampada con interruttore integrato.



IP20

0,500 Kg / 0,0204 m³
LED 10,5W / 1000 lm

€ 150

310107 **Bianco** **new**

310114 **Nero** **new**

310121 **Ottone** **new**



P. 078 P. 404 P. 530



Yoko

Base e montatura in metallo verniciato opaco. Diffusore in policarbonato opale. Cavo in pvc con presa-alimentatore. Colori: bianco o nero.

LED Sorgente luminosa LED 3000 K, 30.000 h di durata.

ON OFF Lampada con interruttore integrato.



258881



258911

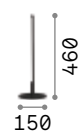

IP20

0,860 Kg / 0,247 m³
LED 5W / 410 lm

€ 85

258881 ■ Bianco
258911 ■ Nero



P. 083



P. 531



Easy new

Montatura in metallo verniciato opaco o placcato. Diffusore orientabile con ottica in acrilico satinato. Cavo in pvc con interruttore e driver integrato sulla spina. Finiture: bianco, nero, ottone spazzolato.

LED Sorgente luminosa LED 3000 K, 50.000 h di durata.

ON OFF Lampada con interruttore integrato.



P. 539



295510



295534



295541



IP20

1,200 Kg / 0,0193 m³
LED 3,5W / 230 lm

€ 90

295510 ■ Bianco new

295534 ■ Nero new

295541 ■ Ottone new



Diesis

Montatura in metallo verniciato a polveri o placcato. Diffusore orientabile in rotazione e inclinazione. Cavo in pvc con interruttore. Colori: nero, nickel satinato oppure ottone satinato.

LED Sorgente luminosa LED 3000 K, 30.000 h di durata.

 Lampada con dimmer.

 Lampada con dimmer tattile.

 
P. 122 P. 539



291093



283333





291109



 IP20  

1,700 Kg / 0,0637 m³
LED 6,5W / 500 lm

€ 185

291093  Nickel
283333  Nero
291109  Ottone



Futura

Braccio in alluminio e plastica, snodato con cavo a vista in pvc. Diffusore orientabile a led e interruttore incorporato. Spina con alimentatore.



LED Sorgente luminosa LED 4000 K, 25.000 h di durata.

ON/OFF Lampada con interruttore integrato.

+ Lampada con dimmer.

Hand icon Lampada con dimmer tattile.

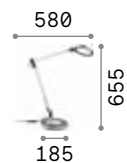

■ □ IP20 **Hand icon** **+**

1,830 Kg / 0,0069 m³
LED 12,5W / 1100 lm

€ 130

272078 ■ Bianco
204895 ■ Alluminio
204888 ■ Nero





Kelly

Lampada tecnica in metallo con
finitura bianco o nero opaco.
Braccio snodato e bilanciato a molle.
Diffusore orientabile.



Lampada con interruttore integrato.

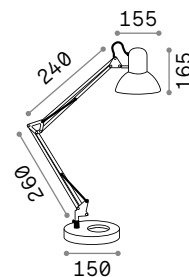

IP20

1,510 Kg / 0,0065 m³
E27 max 1 x 42W

€ 45

108117 ■ Bianco
108094 ■ Nero

3000 K
340 lm

101286 € 2,60



Sally

Lampada tecnica in metallo con finitura bianco, nero opaco oppure nero con snodi in rame. Braccio snodato e bilanciato a molle. Diffusore orientabile.

 Lampada con interruttore integrato.

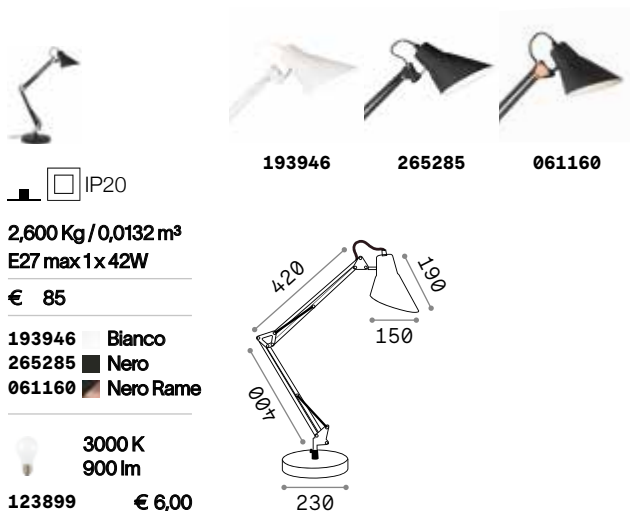

Wally

Lampada tecnica in metallo con finitura bianco, nero opaco oppure nero con snodi in rame. Braccio snodato e bilanciato a molle. Diffusore orientabile.

 Lampada con interruttore integrato.

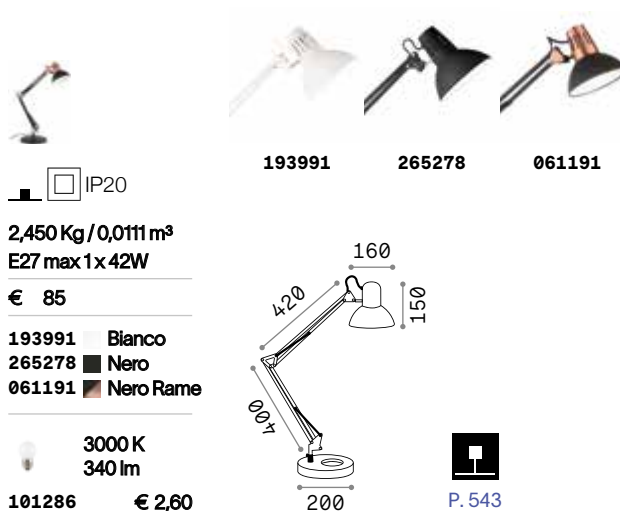



313351

313344

313368



145198

145204

145211



Johnny ^{new}

Montatura e diffusore in metallo verniciato opaco o placcato. Braccio articolato con manopole di serraggio. Diffusore orientabile con interno bianco. Cavo in pvc nero con interruttore. Finiture: nero, nickel satinato, brunito.



Lampada con interruttore integrato.



IP20

2,400 Kg / 0,0109 m³
E14 max 1x25W

€ 110

313351 ■ Nickel ^{new}
313344 ■ Nero ^{new}
313368 ■ Brunito ^{new}

3000 K
480 lm

101200 € 2,50

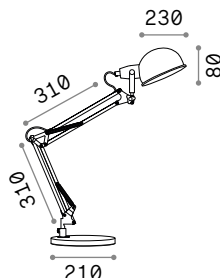

Truman

Montatura e diffusore in metallo rifinito con vernice opaca bianca, grigia o nera. Braccio snodato con raccordi in metallo brunito. Diffusore smaltato bianco all'interno. Cavo rivestito in tessuto vintage bianco e nero.



Lampada con interruttore integrato.



IP20

2,380 Kg / 0,0283 m³
E27 max 1x60W

€ 85

145198 ■ Bianco
145204 ■ Grigio
145211 ■ Nero

3000 K
430 lm

101279 € 2,60

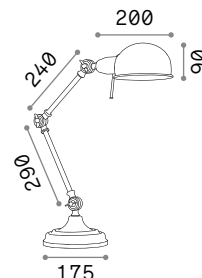



Lawyer

Montatura in metallo con finitura disponibile in ottone, in cromo o in brunito. Diffusore in vetro soffiato e incamiciato.



Lampada con interruttore integrato.



IP20

1,850 Kg / 0,0373 m³
E27 max 1x60W

€ 105

045047 Cromo
013657 Ottone
045030 Brunito



3000 K
910 lm
119571 € 6,00



Lumiere **new**

Montatura e rosone in metallo verniciato opaco con chiusura magnetica. Cavo in pvc trasparente. Diffusore tubolare centrale bianco. Elementi decorativi in vetro soffiato bianco lucido e trasparente grigio.

LED

Sorgente luminosa LED 3000 K, 25.000 h di durata.

**ON
OFF**

Lampada con interruttore integrato.



P. 176



P. 346



P. 520



IP20

2,800 Kg / 0,0290 m³
LED 18W / 2050 lm

€ 170

314204 **Bianco** **new**



Diamond ^{new}

Lampada da tavolo a batteria ricaricabile. Diffusore in acrilico trasparente con lavorazione ad effetto cristallo molato. Interruttore tattile integrato.



LED Sorgente luminosa LED 3000 K, 30.000 h di durata.

ON OFF Lampada con interruttore integrato.

Hand icon Lampada con dimmer tattile.



P. 096



IP20

0,820 Kg / 0,0061 m³
LED 2,2W / 300 lm

€ 85

305349 **Trasparen.new**



Carta new

Montatura in metallo verniciato bianco opaco. Diffusore in policarbonato con rivestimento ad effetto carta.



Lampadine LED G9 4W 3000 K incluse nel modello **317151**. Cod. **209043**



Lampada con interruttore integrato.

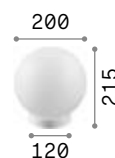

IP20

0,950 Kg / 0,0127 m³
E27 max 1x 25W

€ 80

317168 Bianco new



IP20 INCLUSO

0,400 Kg / 0,0025 m³
G9 max 1x 15W

€ 60

317151 Bianco new



P. 166



P. 293



P. 397



P. 545



101279

3000 K
430 lm

€ 2,60



305486

3000 K
510 Lm

€ 6,00



Smarties ^{new}

Base in metallo. Diffusore in vetro soffiato acidato. Cavo elettrico con spina e interruttore.

LED Lampadine LED G9 4W 3000 K incluse nel modello **032078**. Cod. **209043**

ON/OFF Lampada con interruttore integrato.



IP20

2,600 Kg / 0,0810 m³
E27 max 1x 42W

€ 190

327914 Bianco ^{new} 327907 Bianco ^{new} 032078 Bianco



IP20

1,400 Kg / 0,0392 m³
E27 max 1x 42W

€ 130

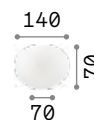

IP20 INCLUSA

0,470 Kg / 0,0079 m³
G9 max 1x 15W

€ 50



P. 152



P. 287



P. 397

3000 K
430 lm

101279 € 2,60

3000 K
430 lm

101279 € 2,60

3000 K
510 Lm

305486 € 6,00



Candy

Montatura in metallo con finitura nickel satinato. Diffusore in vetro bianco soffiato e acidato.



Lampadine LED G9 4W 3000 K incluse.
Cod. **209043**



Lampada con interruttore integrato.



P. 156



P. 290

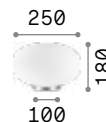

1,200 Kg / 0,0287 m³
G9 max 1x 40W

€ 102

086804 Bianco

3000 K
510 Lm

305486

€ 6,00



Mapa Bianco new

Base e sistema di fissaggio in metallo bianco. Diffusore a sfera in vetro bianco soffiato e acidato.

LED Lampadine LED G9 4W 3000 K incluse nel modello **310817**. Cod. **209043**

ON/OFF Lampada con interruttore integrato.

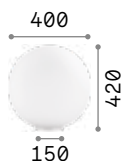

3,520 Kg / 0,1354 m³
E27 max 1x 60W

€ 165

000206 Bianco



P. 164



P. 292



P. 396

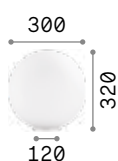

1,880 Kg / 0,0515 m³
E27 max 1x 60W

€ 85

009131 Bianco



3000 K
910 lm

119571 € 6,00

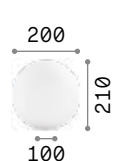

1,050 Kg / 0,0214 m³
E27 max 1x 60W

€ 50

009155 Bianco



3000 K
910 lm

119571 € 6,00

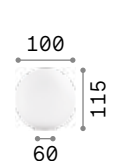

0,280 Kg / 0,0026 m³
G9 max 1x 15W

€ 45

310817 Bianco new



3000 K
510 Lm

305486 € 6,00



Ping Pong new

Montatura in metallo rifinito con vernice a polveri. Diffusori con sfere in acrilico trasparente satinato. Driver integrato. Cavo in pvc con interruttore. Finiture: bianco, nero, ottone spazzolato.

LED Sorgente luminosa LED 3000 K, 50.000 h di durata.

**ON
OFF** Lampada con interruttore integrato.



IP20

1,150 Kg / 0,0232 m³
LED 6W / 500 lm

€ 120

328294 Bianco new
313320 Nero new
328300 Ottone new



Cream new

Corpo luce in ceramica smaltata con fascia bassa in sabbia. Diffusore in vetro soffiato bianco acidato. Cavo in pvc bianco con interruttore e spina.

LED Lampadine LED G9 4W 3000 K incluse.
Cod. **209043**

ON OFF Lampada con interruttore integrato.



0,450 Kg / 0,0128 m³
G9 max 1x15W

€ 35

305264 Bianco new

3000 K
510 lm

305486 € 6,00



0,550 Kg / 0,0128 m³
G9 max 1x15W

€ 35

305271 Bianco new

3000 K
510 lm

305486 € 6,00



Birillo

Lampada da tavolo o da terra con base in metallo cromato e diffusore in vetro soffiato bianco e acidato o fumè.



Lampada con interruttore integrato.



000251



116570

220
390
200



2,310 Kg / 0,0442 m³
E27 max 1x60W

€ 155

000251 ■ Bianco
116587 ■ Fumè

3000 K
910 lm
119571 € 6,00

175
300
150



1,240 Kg / 0,0248 m³
E27 max 1x60W

€ 98

000268 ■ Bianco
116570 ■ Fumè

3000 K
910 lm
119571 € 6,00



Prato

Diffusore in vetro soffiato bianco incamiciato e acidato. Cavo elettrico con spina e interruttore.

ON
OFF Lampada con interruttore integrato.

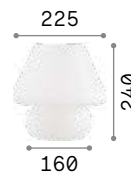

IP20

1,380 Kg / 0,0219 m³
E27 max 1x 60W

€ 80

074702 Bianco

3000 K
340 lm

101286 € 2,60



IP20

0,650 Kg / 0,0099 m³
E14 max 1x 40W

€ 51

074726 Bianco

3000 K
420 lm

101217 € 2,50



Edo

Montatura interna in metallo cromato. Diffusore in vetro bianco soffiato, incamiciato e acidato.



Lampada con interruttore integrato.



IP20

1,150 Kg / 0,0172 m³
E27 max 1x60W

€ 66

044590 Bianco

3000 K
900 lm

123899 € 6,00



IP20

0,730 Kg / 0,0082 m³
E27 max 1x60W

€ 50

044606 Bianco

3000 K
340 lm

101286 € 2,60



Birds

Montatura in metallo verniciato con disco decorativo in ottone satinato. Diffusori in vetro soffiato bianco acidato. Cavo in pvc con interruttore e spina. Colore: nero opaco con dettaglio ottone satinato.



Lampadine LED G9 4W 3000 K incluse.
Cod. **209043**



Lampada con interruttore integrato.



P. 099



P. 337



P. 433



P. 522

130x160



0,900 Kg / 0,0163 m³
G9 max 1x 15W

€ 86

273679 ■ Nero



3000 K
510 lm

305486

€ 6,00



Perlage **new**

Montatura in metallo. Finiture: nero opaco con vetri pirex fumé o ottone satinato con vetri bianchi acidati.

LED

Lampadine LED G9 4W 3000 K incluse.
Cod. **209043**

**ON
OFF**

Lampada con interruttore integrato.

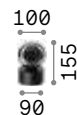
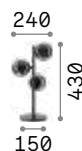

2,000 Kg / 0,0227 m³
G9 max 3 x 15W

€ 175

292472 **Bianco**
292465 **Fumè**
322759 **Ambra** **new**



0,600 Kg / 0,0062 m³
G9 max 1 x 15W

€ 75

292458 **Bianco**
292441 **Fumè**
317823 **Ambra** **new**

3000 K
510 lm
305486 € 6,00

3000 K
510 lm
305486 € 6,00

P. 100 P. 334 P. 435 P. 524



Angolo

Montatura in metallo verniciato a polveri o placcato. Diffusori in vetro bianco, soffiato e acidato. Cavo in PVC nero con interruttore e spina. Finiture: nero oppure ottone satinato.



Lampadine LED G9 4W 3000 K incluse.
Cod. **209043**



Lampada con interruttore integrato.



284316



284361



120

120



0,600 Kg / 0,0063 m³
G9 max 1x28W

€ 75

284316 ■ Nero
284361 ■ Ottone

3000 K
510 lm

305486 € 6,00



P. 344



P. 526



Lingotto new

Montatura in metallo verniciato: base nera opaca e telaio ottone opaco oppure completamente nero opaco. Diffusori in vetro incamiciato bianco, soffiato e acidato.

LED

Lampadine LED G9 4W 3000 K incluse nei modelli: **304151** e **259222**.
Cod. **209043**

**ON
OFF**

Lampada con interruttore integrato.



259222



304151



185

220



120

150

IP20

1,320 Kg / 0,0199 m³
E14 max 1x 28W

€ 125

327877 ■ Nero
251127 ■ Ottone

IP20

0,750 Kg / 0,0084 m³
G9 max 1x 28W

€ 90

new 304151 ■ Nero **new**
259222 ■ Ottone

3000 K
420 lm

101217

€ 2,50

3000 K
510 lm

305486

€ 6,00



P. 094



P. 345



Axel

Base e raccordi in metallo verniciato a polveri. Stelo in legno naturale. Paralume regolabile in altezza, in pvc rivestito di tessuto. Cavo in pvc con interruttore. Colori: bianco o nero.



Lampada con interruttore integrato.

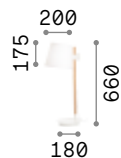

IP20

1,920 Kg / 0,0185 m³
E27 max 1 x 60W

€ 140

282091 ■ Bianco
272238 ■ Nero

3000 K
910 lm

119571 € 6,00



P. 553



London

Montatura in metallo rifinito in cromo o con vernice opaca bianca o nera. Paralume in lamina di PVC rivestito di tessuto, per la versione cromo in lamina di PVC cromata e semi trasparente.



Lampada con interruttore integrato.



110530



032368



110554

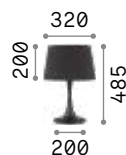

IP20

1,910 Kg / 0,0645 m³
E27 max 1x60W

€ 110

110448 ■ Bianco
032375 ■ Cromo
110455 ■ Nero

3000 K
910 lm

119571 € 6,00

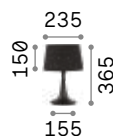

IP20

1,270 Kg / 0,0253 m³
E27 max 1x60W

€ 80

110530 ■ Bianco
032368 ■ Cromo
110554 ■ Nero

3000 K
910 lm

119571 € 6,00



P. 557



Nordik

Montatura in metallo verniciato nero opaco. Paralume in lamina di PVC dorato rivestito in tessuto nero.



Lampada con interruttore integrato.

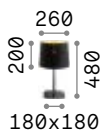

1,220 Kg / 0,0504 m³
E27 max 1x 60W

€ 115

161686 ■ Nero

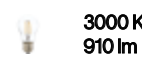

119571

€ 6,00



P. 192



P. 450



P. 560



Luxury

Montatura in metallo rifinita in ottone. Base nera opaca. Paralume in pvc con bordi in tessuto.



Lampada con interruttore integrato.

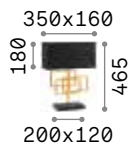

2,890 Kg / 0,0333 m³
E27 max 1x 60W

€ 300

201115 ■ Ottone

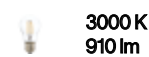

119571

€ 6,00



P. 450



P. 561



Hilton

Montatura in cromo. Paralume in lamina di PVC rivestita in tessuto. Diffusore in vetro trasparente sabbiato.

LED Lampadine LED G9 4W 3000 K incluse nel modello **075525**. Cod. **209043**

ON/OFF Lampada con interruttore integrato.

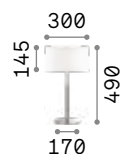

IP20

2,180 Kg / 0,0431 m³
E14 max 2x40W

€ 165

075532 Bianco

3000 K
420 Lm

101217



IP20

0,830 Kg / 0,0109 m³
G9 max 1x40W

€ 110

075525 Bianco

3000 K
510 lm

305486

€ 6,00



P. 195 P. 448 P. 563



Alfiere

Base in metallo cromato. Paralume in lamina di PVC ignifuga colore cromo e semitrasparente.



Lampada con interruttore integrato.

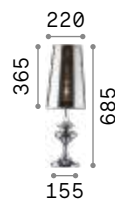

IP20

1,230 Kg / 0,0276 m³
E27 max 1x 60W

€ 126

032436 Cromo

3000 K
910 lm

119571 € 6,00



IP20

0,920 Kg / 0,0139 m³
E27 max 1x 60W

€ 106

032467 Cromo

3000 K
910 lm

119571 € 6,00



Kali

Corpo luce in ceramica con decori in rilievo. Paralume in pvc rivestito con tessuto. Cavo in pvc con interruttore integrato.



Lampada con interruttore integrato.



0,660 Kg / 0,0092 m³
E14 max 1x40W

€ 28

245331 Bianco

3000 K
420 lm
101217 € 2,50

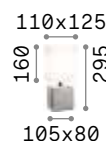

0,620 Kg / 0,0037 m³
E14 max 1x40W

€ 28

245348 Bianco

3000 K
420 lm
101217 € 2,50



0,660 Kg / 0,0055 m³
E14 max 1x40W

€ 28

245393 Bianco

3000 K
420 lm
101217 € 2,50



Set up

Montature in metallo verniciato a polveri o placcato. Paralumi in pvc ignifugo rivestito di tessuto. Colori montature: bianco, nero oppure nickel satinato o ottone spazzolato. Colori paralumi: beige, tortora, bianco o nero.



Lampada con interruttore integrato.



259918

259949

259925

259956

260068

304113

260075

260082



1,130 Kg / 0,0055 m³
E27 max 1x60W

€ 78

259918 Bianco
259949 Nickel
259925 Nero
259956 Ottone

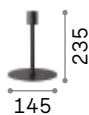

0,680 Kg / 0,0061 m³
E27 max 1x60W

€ 61

259864 Bianco
259895 Nickel
259871 Nero
259901 Ottone



0,023 Kg / 0,0238 m³

€ 55

260433 Bianco
304618 Tortora
270005 Nero
260440 Beige



0,012 Kg / 0,0180 m³

€ 28

260327 Bianco
304601 Tortora
269986 Nero
260334 Beige



0,013 Kg / 0,0180 m³

€ 29

260068 Bianco
304113 Tortora
260075 Nero
260082 Beige



0,011 Kg / 0,0180 m³

€ 25

260341 Bianco
293004 Tortora
270036 Nero
260358 Beige



3000 K
900 lm

123899 € 6,00



3000 K
900 lm

123899 € 6,00



Driftwood

Montatura in metallo. Elementi decorativi con rami di legno naturale. Diffusore in lamina di pvc rivestito con tessuto canvas.



Lampada con interruttore integrato.



P. 241



P. 554

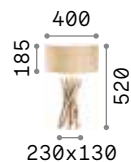

IP20

2,450 Kg / 0,0709 m³
E27 max 1x60W

€ 220

129570 ■ Legno



2200 K
370 Lm

151687

€ 4,60



Snell

Base in legno naturale. Corpo luce formato da rami veri. Paralume in lamina di pvc rivestita di tessuto.



Lampada con interruttore integrato.

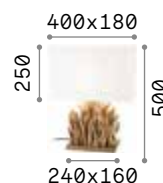

IP20

1,400 Kg / 0,0733 m³
E27 max 1x60W

€ 250

201399 Bianco

3000 K
900 lm

123899 € 6,00

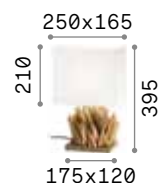

IP20

1,290 Kg / 0,0389 m³
E27 max 1x60W

€ 225

201382 Bianco

3000 K
900 lm

123899 € 6,00



Chalet

Montatura con struttura portante in metallo. Elementi decorativi in resina lavorata artigianalmente e dipinta a mano come fedele riproduzione di corna e legno intagliato.



Lampada con interruttore integrato.



P. 240



P. 460

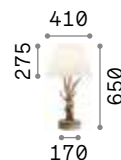

IP20

3,500 Kg / 0,1650 m³
E27 max 1x60W

€ 280

128207 Beige

3000 K
910 lm

119571 € 6,00



Firenze

Corpo luce in resina. Bracci e foglie in metallo modellato artigianalmente. Decorato a mano con foglia d'oro e antichizzato.



Lampada con interruttore integrato.



012889



020853

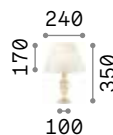

IP20

1,220 Kg / 0,0216 m³
E14 max 1x 40W

€ 135

012889 ■ Bianco
020853 ■ Oro

3000 K
480 lm

101200 € 2,50



P. 236



P. 460



P. 567



Roma

Montatura e dettagli in metallo cromato. Diffusore con elementi quadrati in cristallo molato sulla fascia laterale e vetro sabbato sul fondo.



Lampadine LED G9 4W 3000 K incluse.
Cod. **209043**



Lampada con interruttore integrato.



P. 205



P. 356



P. 454



1,930 Kg / 0,0182 m³
G9 max 1x 40W

€ 145

114620 Cromo

3000 K
510 lm

305486

€ 6,00



Opera

Montatura in cromo. Paralume in lamina di PVC con riflessi metallizzati e rivestita da fili. Pendagli in cristallo molato.



Lampada con interruttore integrato.

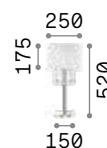

IP20

1,750 Kg / 0,0392 m³
E27 max 1x60W

€ 145

068305 Bianco

3000 K
900 lm

123899

€ 6,00



P. 198



P. 456



P. 511



Kate

Corpo luce con elementi di cristallo trasparente molato. Paralumi in tessuto doppio, plissettato.



Lampada con interruttore integrato.



122878



122885



IP20

2,990 Kg / 0,0605 m³
E27 max 1x 60W

€ 275

122878 Bianco

3000 K
900 lm

123899 € 6,00



IP20

2,810 Kg / 0,0605 m³
E27 max 1x 60W

€ 275

122885 Bianco

3000 K
900 lm

123899 € 6,00



Duchessa

Base e dettagli in metallo cromato.
Elementi decorativi in vetro soffiato
e lavorato a mano. Paralume in
tessuto di organza plissettato.



Lampada con interruttore integrato.



IP20

3,000 Kg / 0,0652 m³
E27 max 1x60W

€ 155

044491 Trasparen.

3000 K
900 lm

123899 € 6,00

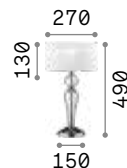

IP20

1,900 Kg / 0,0610 m³
E27 max 1x60W

€ 135

051406 Trasparen.

3000 K
900 lm

123899 € 6,00

Queen

Montatura in metallo dorato con elementi decorativi e base in cristallo molato. Paralume in lamina di PVC, rivestita in tessuto con decorazione trapuntata e brillantini dorati.

ON
OFF Lampada con interruttore integrato.

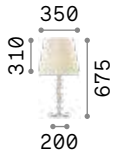

■ □ IP20

2,300 Kg / 0,0886 m³
E27 max 1x60W

€ 210

077758 ■ Oro

■ 3000 K
910 lm

119571 € 6,00

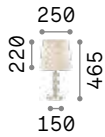

■ □ IP20

1,360 Kg / 0,0460 m³
E27 max 1x60W

€ 140

077741 ■ Oro

■ 3000 K
910 lm

119571 € 6,00

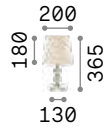

■ □ IP20

0,900 Kg / 0,0137 m³
E27 max 1x60W

€ 120

077734 ■ Oro

■ 3000 K
910 lm

119571 € 6,00

■ □
P. 566



Le Roy

Montatura e base in metallo cromato con elementi decorativi in cristallo molato. Paralume in lamina di PVC, rivestita in tessuto con decorazione trapuntata e brillantini argentati.

ON
OFF Lampada con interruttore integrato.

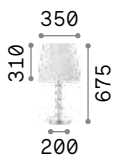

■ □ IP20

2,300 Kg / 0,0919 m³
E27 max 1x60W

€ 195

073408 ■ Cromo

■ 3000 K
910 lm

119571 € 6,00

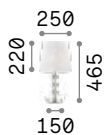

■ □ IP20

1,360 Kg / 0,0456 m³
E27 max 1x60W

€ 127

073422 ■ Cromo

■ 3000 K
910 lm

119571 € 6,00

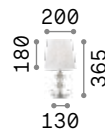

■ □ IP20

0,900 Kg / 0,0234 m³
E27 max 1x60W

€ 110

073439 ■ Cromo

■ 3000 K
910 lm

119571 € 6,00





Pegaso

Montatura in metallo cromato oppure ottone satinato. Corpo centrale, bobeches e pendagli in cristallo molato. Paralumi in organza.



Lampada con interruttore integrato.



059266



197753

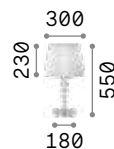

IP20

2,000 Kg / 0,0705 m³
E27 max 1x60W

€ 215

059259 ■ Bianco

3000 K
900 lm

123899 € 6,00

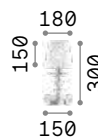

IP20

1,450 Kg / 0,0117 m³
E14 max 1x28W

€ 110

059266 ■ Bianco
197753 ■ Ottone

3000 K
420 lm

101217 € 2,50



P. 214



P. 457



P. 566



Interni

Lampade da terra

Indice alfabetico

Angolo	526	Klimt	555
Audio	527	Lift	541
Axel	553	London	557
Birds	522	Look	534
Carta	545	Lumiere	520
Colonna	562	Luxury	561
Comet	546	Mix Up	536
Comfort	540	Newton	542
Craft	538	Nordik	560
Cylinder	560	Opera	565
Daddy	550	Pagoda	551
Diesis	539	Pegaso	566
Dorsale	548	Perlage	524
Driftwood	554	Ping Pong	533
Easy	539	Polly	544
Elvis	542	Queen	566
Eminent	552	Regol	556
Equinoxe	525	Set Up	558
Eva	532	Wally	543
Filo	404	Yoko	531
Firenze	567	York	555
Forcola	564		
Frame	528		
Futura	541		
Hilton	563		



new



Lumiere 520

new



Birds 522



Perlage 524



Equinoxe 525



Angolo 526



Audio 527

new



Frame 528

new



Easy 539



Diesis 539



Comfort 540

new



Lift 541



Futura 541

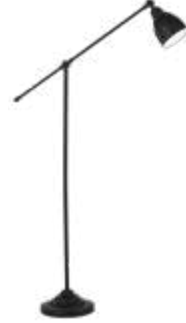

Newton 542



Elvis 542



Daddy 550



Pagoda 551



Eminent 552



Axel 553



Driftwood 554



York 555

Interni

Indice icone



Filo 530



Yoko 531



Eva 532

new



Ping Pong 533

new



Look 534

new



Mix Up 536



Craft 538



Wally 543



Polly 544

new



Carta 545

new



Comet 546



Dorsale 548



Klimt 555



Regol 556



London 557



Set Up 558



Cylinder 560



Nordik 560



Luxury 561



Colonna 562



Hilton 563



Forcola 564



Opera 565



Queen 566



Pegaso 566



Firenze 567



Lumiere new

Montatura e dettagli in metallo verniciato nero opaco. Diffusore tubolare centrale bianco. Elementi decorativi in vetro soffiato bianco lucido e trasparente grigio. Cavo in pvc.

LED Sorgente luminosa LED 3000 K, 25.000 h di durata.

ON
OFF Lampada con interruttore integrato.



 IP20

10,500 Kg / 0,1515 m³
LED 53W / 7350 lm

€ 500

314198  Bianco new



P. 176



P. 346



P. 482



Birds

Montatura in metallo verniciato con disco decorativo in ottone satinato. Diffusori in vetro soffiato bianco acidato. Cavo in pvc con interruttore e spina. Colore: nero opaco con dettaglio ottone satinato.

LED Lampadine LED G9 4W 3000 K incluse.
Cod. **209043**

ON
OFF Lampada con interruttore integrato.

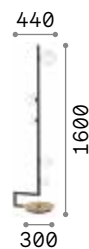

IP20 INCLUSA

5,640 Kg / 0,1536 m³
G9 max 5 x 15W

€ 340

273662 ■ Nero

3000 K
510 lm
305486 € 6,00



P. 099



P. 337



P. 433



P. 494



Perlage new

Montatura in metallo. Diffusori in vetro soffiato. Finiture: nero opaco con vetri ambra o pirex fumè oppure ottone satinato con vetri bianchi acidati.

LED Lampadine LED G9 4W 3000 K incluse.
Cod. **209043**

ON OFF Lampada con interruttore integrato.

317816

277967

306988

320
1640
250

IP20

4,800 Kg / 0,0612 m³
G9 max 4 x 15W

€ 285

277967 ■ Bianco
306988 ■ Fumè
317816 ■ Ambra new

305486 **€ 6,00**

P. 100 P. 334 P. 435 P. 495



Equinoxe

Montatura a bracci in metallo con finitura cromo o ottone antico. Diffusori in vetro soffiato trasparente.

LED

Lampadine LED G4 2W 3000 K incluse.
Cod. 222257

**ON
OFF**

Lampada con interruttore integrato.



P. 102





P. 437



IP20   INCLUSA

6,500 Kg / 0,0882 m³
G4 max 4 x 2W

€ 500

290959  Cromo
290966  Ottone

 3000 K
200 lm

222257 € 4,00



Angolo

Montatura in metallo verniciato a polveri o placcato. Diffusori in vetro bianco, soffiato e acidato. Cavo in PVC nero con interruttore e spina. Finiture: nero oppure ottone satinato.

LED Lampadine LED G9 4W 3000 K incluse. Cod. **209043**

ON OFF Lampada con interruttore integrato.



P. 344



P. 496

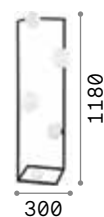

IP20  

2,700 Kg / 0,1772 m³
G9 max 5 x 28W

€ 280

284309 ■ Nero
284354 ■ Ottone

3000 K
510 lm
305486 € 6,00















Audio

Montatura e diffusori orientabili in metallo verniciato a polveri. Cavo di alimentazione in PVC con spina e interruttore incorporato. Finiture: nero.

LED Lampadine LED GU10 10W 3000 K incluse. Cod. **189031**

ON/OFF Lampada con interruttore integrato.

		
340x210	210x210	380x190
 IP20  INCLUSA	 IP20  INCLUSA	 IP20  INCLUSA
7,400 Kg / 0,1063 m ³ GU10 max 2 x 50W	6,270 Kg / 0,0772 m ³ GU10 max 3 x 50W	2,000 Kg / 0,0213 m ³ GU10 max 2 x 50W
€ 350	€ 350	€ 200
293691 ■ Nero	293684 ■ Nero	279312 ■ Nero
 3000 K 800 lm	 3000 K 800 lm	 3000 K 800 lm
189031 € 15,00	189031 € 15,00	189031 € 15,00

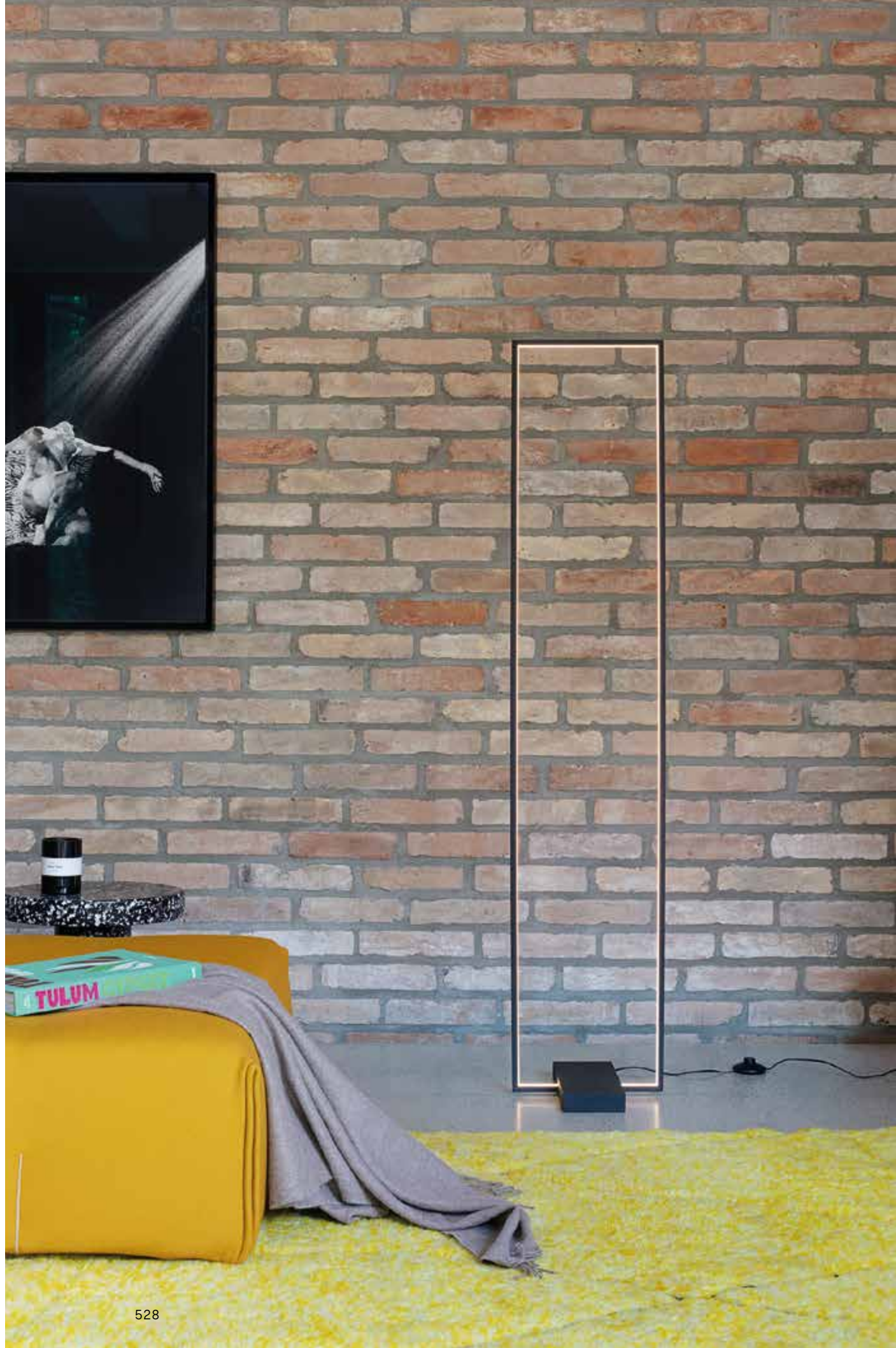

Frame new

Base e montatura in metallo verniciato bianco opaco o nero opaco. Diffusori in materiale plastico colore opale. Emissione luce diretta.

LED Sorgente luminosa LED 3000 K, 30.000 h di durata.

**ON
OFF** Lampada con interruttore integrato.

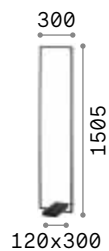
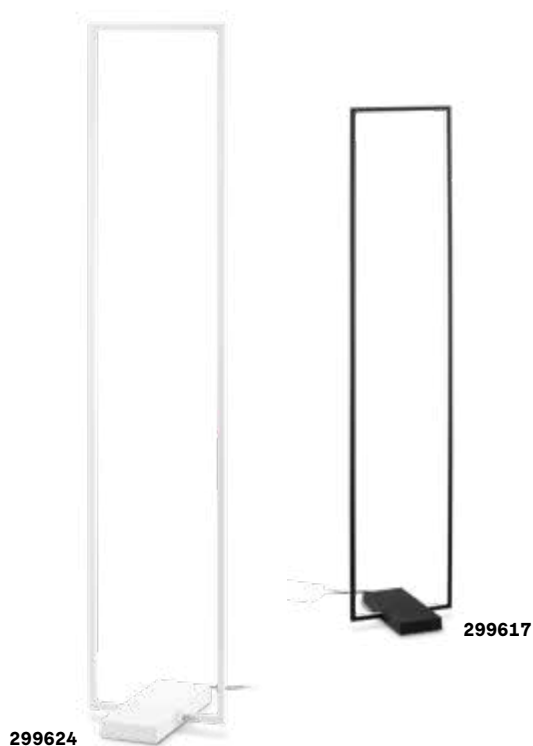

IP20

10,300 Kg / 0,0525 m³
LED 30W / 3000 lm

€ 450

299624 ■ Bianco new
299617 ■ Nero new



P. 072



P. 254



Filo

Rosone, corpo luce e base a terra in metallo verniciato a polveri o placcato. Diffusore in PC opale satinato. Cavo di sostegno in PVC nero. Alimentato dalla base a terra da cavo nero in PVC con spina. Finiture: bianco, nero oppure ottone.



LED Sorgente luminosa LED 3000 K, 20.000 h di durata.

ON OFF Lampada con interruttore integrato.

  
 P. 078 P. 404 P. 472

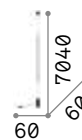

 IP20

1,200 Kg / 0,0124 m³
 LED 15W / 1900 lm

€ 250

301051  Bianco
 301068  Nero
 301075  Ottone



Yoko

Base e montatura in metallo verniciato opaco. Diffusore in policarbonato opale. Cavo in pvc con presa-alimentatore. Colori: bianco o nero.

LED Sorgente luminosa LED 3000 K, 30.000 h di durata.

ON OFF Lampada con interruttore integrato.



P. 083



P. 473

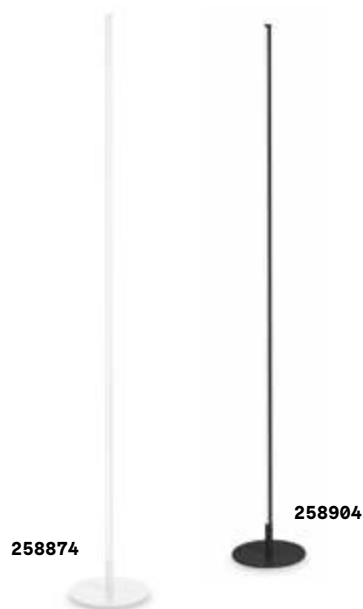

IP20

1,650 Kg / 0,0534 m³
LED 16W / 1350 lm

€ 135

258874 ■ Bianco
258904 ■ Nero



Eva

Base in marmo. Montatura in metallo verniciato a polveri. Cavo in PVC con interruttore e spina. Finiture: nero.



Lampada con interruttore integrato.



IP20

8,500 Kg / 0,0680 m³
E27 max 1x60W

€ 250

295213 ■ Nero

3000 K
1020 lm

101347 € 8,00



Ping Pong ^{new}

Montatura in metallo rifinito con vernice a polveri. Diffusori con sfere in acrilico trasparente satinato. Driver integrato. Cavo in pvc con interruttore. Finiture: bianco, nero, ottone spazzolato.

LED Sorgente luminosa LED 3000 K, 50.000 h di durata.

ON/OFF Lampada con interruttore integrato.

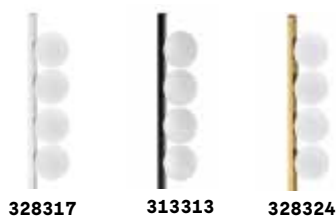

IP20

2,500 Kg / 0,0916 m³
LED 11W / 1000 lm

€ 240

328317 **Bianco** ^{new}
313313 **Nero** ^{new}
328324 **Ottone** ^{new}

P. 348 P. 440 P. 488

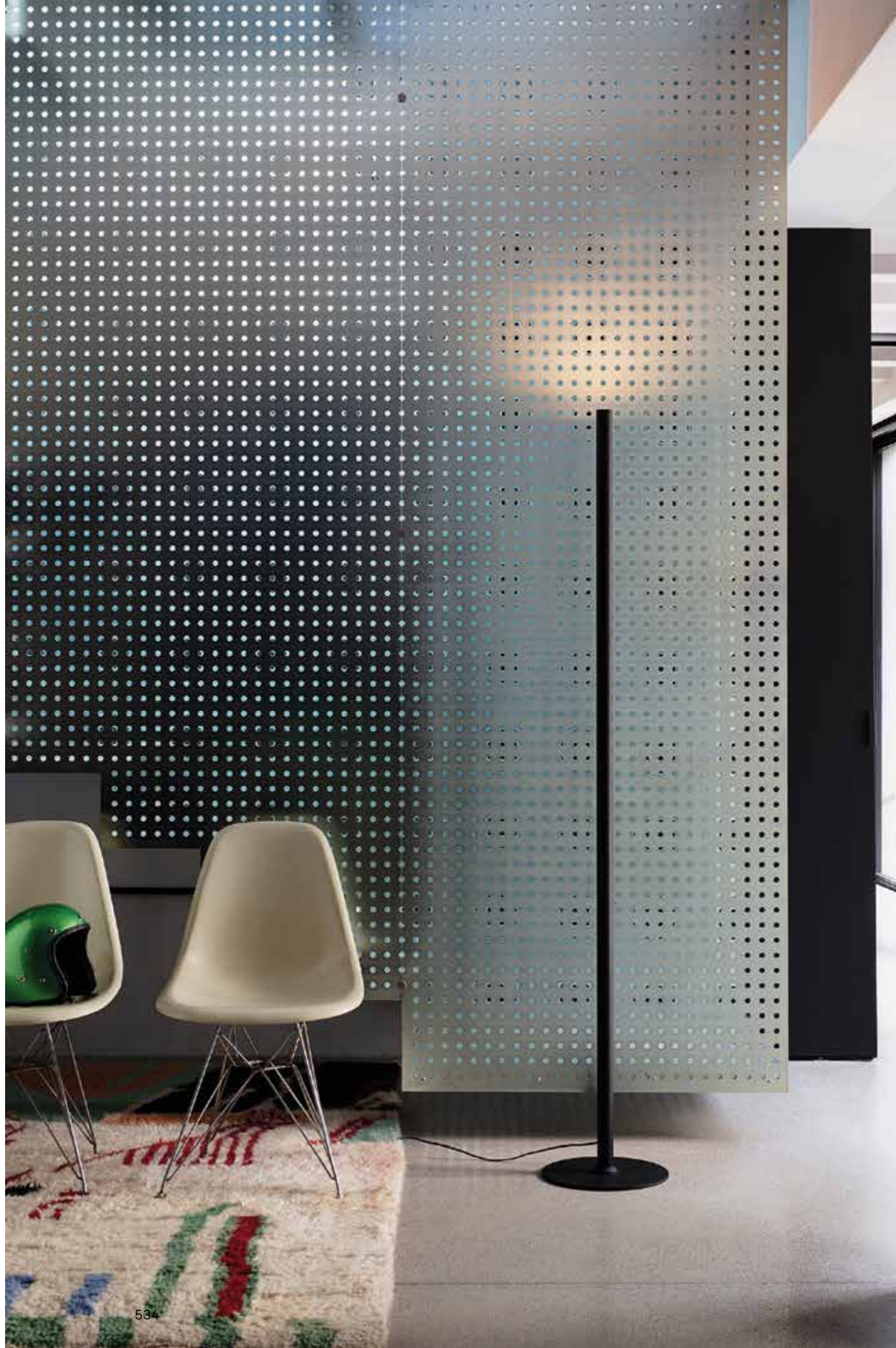

Look new

Base in metallo e corpo luce in alluminio verniciati a polveri.
Diffusore in vetro trasparente. Cavo in pvc. Driver con dimmer da terra.
Finiture: bianco, nero.

LED Sorgente luminosa LED 3000 K,
30.000 h di durata.

 Lampada con dimmer.

 Lampada con interruttore integrato.

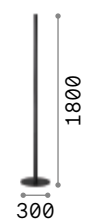

  IP20 

5,080 Kg / 0,0809 m³
LED 24W / 2850 lm

€ 240

304922  Bianco new
304915  Nero new



Mix Up new

Montatura e paralumi intercambiabili in metallo verniciato a polveri. Finiture: bianco oppure nero.



Lampada con interruttore integrato.



288451

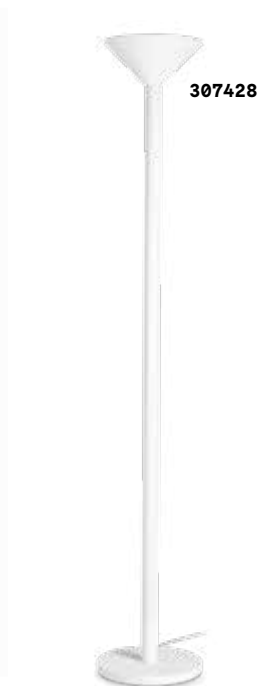

307428

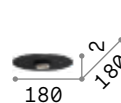
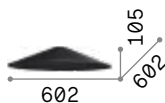

8,500 Kg / 0,0326 m³
E27 max 1x 42W

€ 200

328164 ■ Bianco
328171 ■ Nero

2,000 Kg / 0,0676 m³

€ 85

new 288437 ■ Bianco
new 288420 ■ Nero

1,100 Kg / 0,0446 m³

€ 55

307404 ■ Bianco
288475 ■ Nero

0,800 Kg / 0,0147 m³

€ 40

307411 ■ Bianco
288444 ■ Nero

0,500 Kg / 0,0174 m³

€ 35

307428 ■ Bianco
288451 ■ Nero

0,340 Kg / 0,0008 m³

€ 20

307435 ■ Bianco
288482 ■ Nero

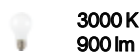

3000 K
900 lm

123899 € 6,00





Craft

Base in metallo verniciato nero opaco. Corpo luce in legno naturale. Diffusore in policarbonato opale satinato. Cavo in PVC nero con dimmer e spina.



LED Sorgente luminosa LED 3000 K, 20.000 h di durata.

+ Lampada con dimmer.

ON/OFF Lampada con interruttore integrato.

P. 085 **P. 386**

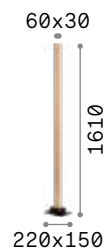

IP20

3,500 Kg / 0,0586 m³
LED 26W / 2250 lm

€ 395

284484 ■ **Legno**



Diesis

Montatura in metallo verniciato a polveri o placcato. Diffusore orientabile in rotazione e inclinazione. Cavo in pvc con interruttore. Colori: nero, nickel satinato oppure ottone satinato.

LED Sorgente luminosa LED 3000 K, 20.000 h di durata.



IP20

3,500 Kg / 0,0222 m³
LED 4,5W / 300 lm

€ 205

285337 ■ Nickel
279800 ■ Nero
285344 ■ Ottone



P. 122



P. 475

Easy ^{new}

Montatura in metallo verniciato opaco o placcato. Diffusore orientabile con ottica in acrilico satinato. Cavo in pvc con interruttore e driver integrato sulla spina. Finiture: bianco, nero, ottone spazzolato.

LED Sorgente luminosa LED 3000 K, 50.000 h di durata.



IP20

3,000 Kg / 0,0175 m³
LED 3,5W / 230 lm

€ 130

295473 ■ Bianco ^{new}
295497 ■ Nero ^{new}
295503 ■ Ottone ^{new}



P. 474



Comfort

Montatura in alluminio verniciato a polveri. Diffusore in policarbonato opale anti abbagliamento. Emissione luce sopra e sotto. Interruttore con dimmer, sensore di luminosità, presa USB. Cavo in PVC, con spina. Finiture: bianco oppure nero.

LED Sorgente luminosa LED 3000/4000 K, 50.000 h di durata.

+ Lampada con dimmer.

USB Lampada con presa USB integrata.

UGR Articolo con UGR <19.



IP20

12,700 Kg / 0,0326 m³
LED 76W / 10300/11500 lm

€ 800

296685	Bianco	3000K
306452	Bianco	4000K
296678	Nero	3000K
306469	Nero	4000K



Lift new

Montatura in metallo verniciato opaco. Diffusore regolabile in altezza e orientabile con policarbonato opale. Cavo in pvc con driver e interruttore da terra. Finiture: bianco, nero.



LED Sorgente luminosa LED 3000 K, 50.000 h di durata.

ON/OFF Lampada con interruttore integrato.

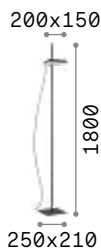

IP20

5,150 Kg / 0,0195 m³
LED 17W / 1950 lm

€ 196

321585 **Bianco** new
305592 **Nero** new

Futura

Braccio in alluminio e plastica, snodato con cavo a vista in pvc. Diffusore orientabile a led e interruttore incorporato. Spina con alimentatore.



LED Sorgente luminosa LED 4000 K, 25.000 h di durata.

Hand icon Lampada con dimmer tattile.

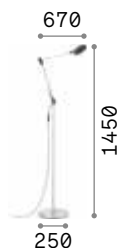

IP20

4,440 Kg / 0,0095 m³
LED 12,5W / 1100 lm

€ 190

272085 **Bianco**
204956 **Alluminio**
204949 **Nero**



P. 476



015286

003528



042794

001197



Newton

Montatura e diffusore in metallo. Disponibile con finitura in nickel satinato o con vernice nera opaca. Braccio regolabile. Diffusore orientabile smaltato bianco all'interno.



Lampada con interruttore integrato.

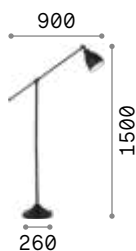

5,270 Kg / 0,0323 m³
E27 max 1x 42W

€ 120

015286 ■ Nickel
003528 ■ Nero



3000 K
900 lm



123899 € 6,00 P. 438

Elvis

Montatura in metallo cromato. Diffusore orientabile in metallo colorato e dettagli in cromo all'esterno, smaltato bianco all'interno.



Lampada con interruttore integrato.

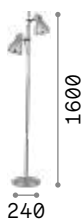

3,600 Kg / 0,0277 m³
E27 max 2x 60W

€ 150

042794 ■ Argento
001197 ■ Nero



3000 K
910 lm

119571 € 6,00



Wally

Montatura in metallo verniciato a polveri con finitura nera, dettagli in metallo nickelato. Struttura a braccio articolato regolabile. Interruttore incorporato sulla testa del paralume. Cavo in pvc.



Lampada con interruttore integrato.

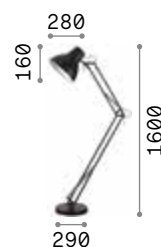

IP20

8,500 Kg / 0,0771 m³
E27 max 1x 42W

€ 250

265292 ■ Nero

3000 K
950 lm

101330 € 7,50



P. 479



Polly

Diffusori e base in metallo cromato, alluminio o smaltato nero. Dettagli e raccordi in metallo cromato. Diffusori orientabili.



Lampada con interruttore integrato.



IP20

3,500 Kg / 0,0207 m³
E27 max 2 x 60W

€ 120

061122 Cromo
061115 Argento
061139 Nero

3000 K
910 lm

119571 € 6,00



Carta ^{new}

Montatura in metallo verniciato bianco opaco. Diffusore in policarbonato con rivestimento ad effetto carta.



Lampada con interruttore integrato.

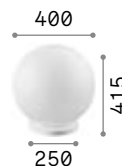

IP20

3,150 Kg / 0,0813 m³
E27 max 1x25W

€ 225

317144 Bianco ^{new}

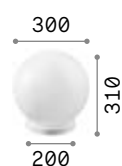

IP20

1,900 Kg / 0,0370 m³
E27 max 1x25W

€ 110

317137 Bianco ^{new}



P. 166 P. 293 P. 397 P. 484

3000 K
910 lm
119571 € 6,00

3000 K
910 lm
119571 € 6,00





Comet new

Base e corpo luce in metallo verniciato a polveri. Diffusore in silicone opale. Interruttore touch integrato su corpo luce. Cavo in pvc con driver e spina. Finiture: bianco, nero.

LED Sorgente luminosa LED 3000 K, 20.000 h di durata.

 Lampada con dimmer.

 Lampada con dimmer tattile.

 Lampada con interruttore integrato.

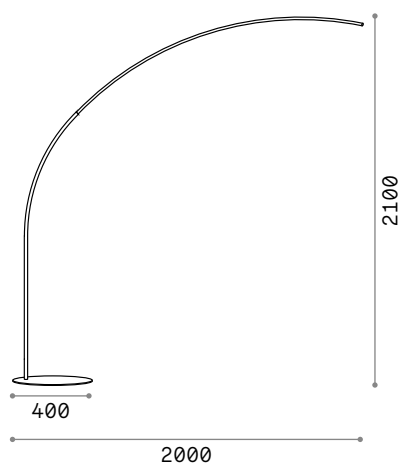
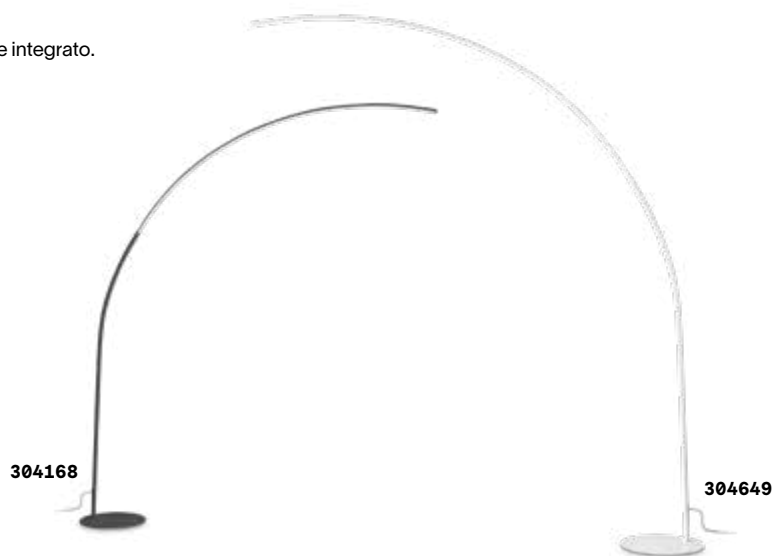

3,800 Kg / 0,0574 m³
LED 30W / 2850 lm

€ 295

304649  Bianco new
304168  Nero new



Dorsale

Montatura in metallo rifinito in cromo o con vernice opaca bianca o nera. Braccio a sezione quadrata composto da tre elementi. Paralume in lamina di PVC, disponibile in colore cromo o rivestita in tessuto bianco o nero.



Lampada con interruttore integrato.

046471



041742

046723

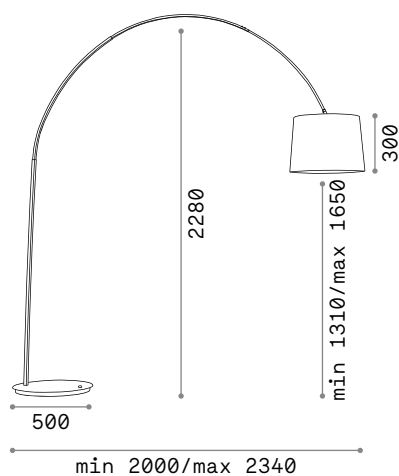
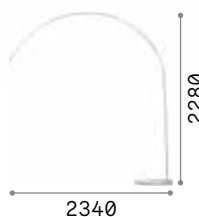

12,000 Kg / 0,0856 m³
E27 max 1x60W

0,430 Kg / 0,0709 m³

€ 600

€ 75

286686 Bianco
286662 Cromo
286679 Nero

046723 Bianco
041742 Cromo
046471 Nero



3000 K
1020 lm

101347

€ 8,00





Daddy

Montatura in metallo. Disponibile in nero e bianco opaco con paralume rivestito in tessuto.



Lampada con interruttore integrato.



110356

110363

IP20

7,250 Kg / 0,1287 m³
E27 max 1 x 60W

€ 340

110356 ■ Bianco
110363 ■ Nero

3000 K
1020 lm

101347 € 8,00



Pagoda

Montatura e base in metallo rifinito con smalto satinato. Paralume a inclinazione regolabile rivestito di tessuto.



Lampada con interruttore integrato.

051741 051765 062273

260
470
1840
975

IP20

10,870 Kg / 0,1732 m³
E27 max 1x60W

€ 390

051741 ■ Bianco
062273 ■ Argento
051765 ■ Nero

3000 K
1020 lm
101347 € 8,00



Eminent

Montatura in metallo verniciato a polveri di colore bianco o nero. Asta in legno naturale. Paralume in pvc rivestito con tessuto. Cavo rivestito in tessuto con interruttore.

ON / **OFF** Lampada con interruttore integrato.

207582

207599

420

280

2300

1660

IP20

10,610 Kg / 0,1120 m³
E27 max 1 x 60W

€ 525

207582 ■ Bianco
207599 ■ Nero

3000 K
900 lm

101354 € 8,00



Axel

Base e raccordi in metallo verniciato a polveri. Stelo in legno naturale. Paralume regolabile in altezza, in pvc rivestito di tessuto. Cavo in pvc con interruttore. Colori: bianco o nero.



Lampada con interruttore integrato.



272245

282084

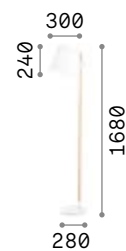

IP20

5,200 Kg / 0,0818 m³
E27 max 1x 60W

€ 230

272245 ■ Bianco
282084 ■ Nero

3000 K
1020 lm

101347 € 8,00



P. 498



Driftwood

Montatura in metallo. Elementi decorativi con rami di legno naturale. Diffusore in lamina di pvc rivestito con tessuto canvas.



Lampada con interruttore integrato.



IP20

5,830 Kg / 0,3487 m³
E27 max 1x 60W

€ 645

148939 Legno

2200 K
370 lm

151687 € 4,60

IP20

24,000 Kg / 0,1753 m³
E27 max 2x 60W

€ 720

180946 Legno

2200 K
370 lm

151687 € 4,60



P. 241



P. 506



York

Base in legno naturale con dettagli in metallo. Paralume in lamina di pvc rivestito in tessuto. Cavo esterno in tessuto. Disponibile anche con montatura e paralume bianchi o neri.



Lampada con interruttore integrato.

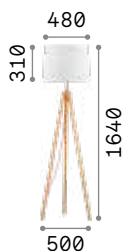

2,810 Kg / 0,0247 m³
E27 max 1x60W

€ 230

121406 ■ Bianco
121437 ■ Nero
089805 ■ Legno

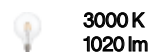

3000 K
1020 lm

101347 € 8,00

Klimt

Treppiede in legno naturale. Paralume in lamina di pvc rivestita in tessuto e con supporto in metallo cromato.



Lampada con interruttore integrato.

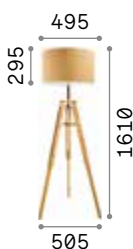

3,870 Kg / 0,1284 m³
E27 max 1x60W

€ 400

137827 ■ Legno



3000 K
1020 lm

101347 € 8,00



Regol

Montatura snodata in metallo.
 Diffusore regolabile ad altezze diverse. Disponibile con finitura nickel satinato e paralume rivestito in tessuto bianco.



Lampada con interruttore integrato.



IP20

5,420 Kg / 0,0702 m³
 E27 max 1x60W

€ 280

014609 Bianco

3000 K
 1020 lm

101347 € 8,00



London

Montatura in metallo rifinito in cromo o con vernice opaca bianca o nera. Paralume in lamina di PVC rivestito di tessuto, per la versione cromo in lamina di PVC cromata e semi trasparente.



Lampada con interruttore integrato.



110233



032382



110240

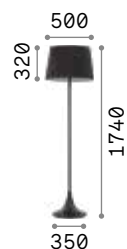

IP20

7,120 Kg / 0,1879 m³
E27 max 1x60W

€ 300

110233 ■ Bianco
032382 ■ Cromo
110240 ■ Nero



3000 K
1020 lm

101347

€ 8,00



P. 499



Set up

Montature in metallo verniciato a polveri o placcato. Paralumi in pvc ignifugo rivestito di tessuto. Colori montature: bianco, nero oppure nickel satinato o ottone spazzolato. Colori paralumi: beige, tortora, bianco o nero.



Lampada con interruttore integrato.



259963 259994 259970 260006 260136 304120 260235 260242



2,640 Kg / 0,0251 m³
E27 max 1x60W

€ 145

- 259963 Bianco
- 259994 Nickel
- 259970 Nero
- 260006 Ottone

0,047 Kg / 0,0221 m³

€ 85

- 260457 Bianco
- 304625 Tortora
- 270012 Nero
- 260464 Beige

0,046 Kg / 0,0709 m³

€ 65

- 260136 Bianco
- 304120 Tortora
- 260235 Nero
- 260242 Beige

3000 K
900 lm
123899 € 6,00



Cylinder

Base in metallo verniciato bianco opaco. Diffusore in vetro soffiato bianco incamiciato e acidato.



Lampada con interruttore integrato.

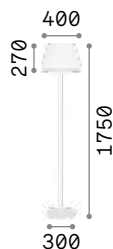

10,010 Kg / 0,1145 m³
E27 max 2x 60W

€ 260

111452 ■ Bianco

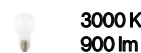

123899

€ 6,00



P. 193



Nordik

Montatura in metallo verniciato nero opaco. Paralume in lamina di PVC dorato rivestito in tessuto nero.



Lampada con interruttore integrato.

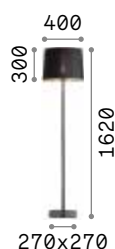

3,620 Kg / 0,0897 m³
E27 max 1x 60W

€ 240

161716 ■ Nero

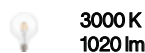

101347

€ 8,00



P. 192



P. 450



P. 500



Luxury

Montatura in metallo rifinita in ottone. Base nera opaca. Paralume in pvc con bordi in tessuto.



Lampada con interruttore integrato.

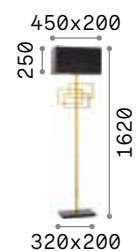

7,440 Kg / 0,1354 m³
E27 max 1x60W

€ 580

201122  Ottone

 3000 K
1020 lm

101347 € 8,00



P. 450 P. 500





Colonna

Montatura in metallo verniciato bianco o nero opaco. Diffusore in acrilico. Cavo in tessuto. Lampadine a LED sostituibili.



Lampadine LED GX53 9W 3000 K incluse. Cod. **123936**



Lampada con interruttore integrato.



177199



177205



7,740 Kg / 0,0710 m³
GX53 max 4 x 15W

€ 350

177199 ■ Bianco
177205 ■ Nero

3000 K
910 lm

123936 **€ 5,50**



Hilton

Montatura in cromo. Paralume in lamina di PVC rivestita in tessuto. Diffusore in vetro trasparente sabbiato.



Lampada con interruttore integrato.

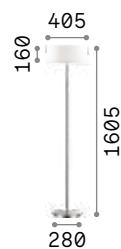

IP20

6,600 Kg / 0,0739 m³
E14 max 2 x 40W

€ 270

075488 Bianco

3000 K
420 lm

101217 € 2,50



P. 195



P. 448



P. 501



Forcola

Montatura e dettagli in metallo cromato. Corpo luce in vetro trasparente soffiato e lavorato a mano. Diffusore in lamina di PVC rivestita di tessuto.



Lampada con interruttore integrato.

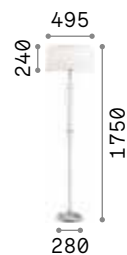

IP20

8,480 Kg / 0,2518 m³
E27 max 1x60W

€ 525

142616 Bianco

3000 K
900 lm

101354 € 8,00



Opera

Montatura in cromo. Paralume in lamina di PVC con riflessi metallizzati e rivestita da fili. Pendagli in cristallo molato.



Lampada con interruttore integrato.

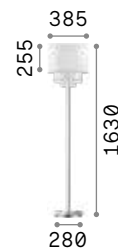

IP20

5,720 Kg / 0,0770 m³
E27 max 1x60W

€ 315

068275 Bianco

3000 K
900 lm

101354

€ 8,00



P. 198



P. 456



P. 511



Queen

Montatura in metallo dorato con elementi decorativi e base in cristallo molato. Paralume in lamina di PVC, rivestita in tessuto con decorazione trapuntata e brillantini dorati.



Lampada con interruttore integrato.



4,900 Kg / 0,0979 m³
E27 max 1x60W

€ 370

077765 Oro



3000 K
1020 lm



101347

€ 8,00

P. 514

Pegaso

Montatura in metallo cromato. Corpo centrale, bobeches e pendagli in cristallo molato. Paralumi in organza.



Lampada con interruttore integrato.



5,450 Kg / 0,0985 m³
E27 max 1x60W

€ 340

059228 Bianco



3000 K
900 Lm



101354

€ 8,00

P. 214



P. 457



P. 515



Firenze

Corpo luce in resina. Bracci e foglie in metallo modellato artigianalmente. Decorato a mano con foglia d'oro e antichizzato.



Lampada con interruttore integrato.



002880



020877

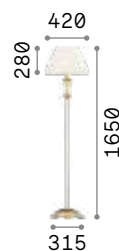

IP20

5,600 Kg / 0,1089 m³
E27 max 1x60W

€ 340

002880 ■ Bianco
020877 ■ Oro

3000 K
1020 lm

101347 € 8,00



P. 236



P. 460



P. 509

























Interni

Sistemi

Indice alfabetico

Arca	570
Chef	648
Ego	584
Fluo	632
Linus	630
Office	646
Steel	642
Stick	616

Indice icone

				
Arca Track 572	Arca Accent 574	Arca Wide 576	Arca Pendant 578	
new 	new 	new 	new 	new 
Ego Single 586	Ego Double 590	Ego Big 592	Ego Flat 594	Ego Accent 596
new 		new 		
Ego Wide 598	Ego Flexible 600	Ego Pendant 602		
new 	new 	new 	new 	
Stick Single 618	Stick Double 620	Stick Accent 622	Stick Wide 624	
				
Linus 630	Fluo Accent 634	Fluo Wide 636	Fluo Biemission 638	Steel 642
	new 			
Office 646	Chef 648			



Arca

Sistema lineare in alluminio estruso compatibile con un'ampia scelta di apparecchi illuminanti a fissaggio meccanico. Il sistema è anodizzato e verniciato. Disponibile in colore nero e nelle modalità d'installazione a plafone, a sospensione oppure a incasso a filo in soffitti di cartongesso. Moduli componibili a seconda della disposizione desiderata. La sezione della scocca per le versioni a soffitto e a sospensione è larga 42 mm e alta 85 mm, mentre quella per la versione a incasso è larga 86 mm e alta 90 mm. Entrambi i modelli sono disponibili in due lunghezze: 1000 mm e 3000 mm. Possibilità di assemblaggio con diversi moduli sorgente: il modulo WIDE diffondente, il modulo ACCENT con controllo dell'UGR inferiore a 13, i moduli TRACK, TRACK FLAT oppure PENDANT per un'illuminazione SPOT con differenti angoli di emissione. Il modulo CORNER per composizioni angolari. LED integrati, possibilità di temperatura di colore di 3000 K o di 4000 K, binning iniziale ≤ 3 -Step MacAdam, protezione IP20, classe isolamento III, durata utile LED 50.000 h L70B50. L'alimentazione in 48Vdc conferisce grande versatilità e sicurezza, con composizioni reversibili e modificabili all'occorrenza. Sistema adatto per ambienti dove viene richiesta un'illuminazione professionale dal design minimale, come ad esempio UFFICI e spazi COMMERCIALI.

PRO Prodotto ad alto contenuto tecnologico, elevata qualità dei materiali, destinato ad uso professionale.

UGR Articolo con UGR <13, <16 (Accent, Pendant).

Sorgente	LED COB / SMD
Driver incluso	No
Driver disponibili	On/Off
MacAdam	SDCM 3
CCT	3000 K / 4000 K
CRI	$\geq 80 / \geq 90$
UGR	<13, <16 (Accent, Pendant)
Durata LED	50.000h
Classe isolamento	III
IP	20
Materiale	Alluminio
Garanzia	5 anni





Arca Track

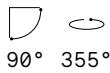
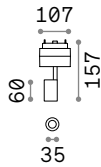

0,200 Kg/0,0015 m³

LED SMD CREE

Potenza	Angolo	Lumen	CCT	Finitura	Codice	€
5W	34°	450 lm	3000 K	Nero	222974	109
		490 lm	4000 K	Nero	223056	109



LENS

Necessario	Angolo	Codice	€
No	20°	223087	8

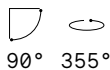
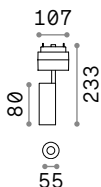

0,460 Kg/0,0030 m³

LED COB CITIZEN

Potenza	Angolo	Lumen	CCT	Finitura	Codice	€
14W	36°	1550 lm	3000 K	Nero	222967	140
		1650 lm	4000 K	Nero	223049	140



LENS

Necessario	Angolo	Codice	€
No	18°	223094	8

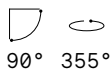
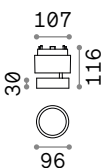

0,330 Kg/0,0031 m³

LED COB CITIZEN CRI ≥ 90

Potenza	Angolo	Lumen	CCT	Finitura	Codice	€
9W	36°	1100 lm	3000 K	Nero	290621	140



Light beam: ACCENT

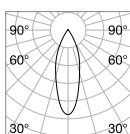

m	lx	Øm
1	553	0,58
2	138	1,16
3	61	1,75
4	35	2,33
5	22	2,91



CRI ≥ 80 5W 34° 450lm 3000K

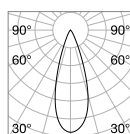

m	lx	Øm
1	2336	0,60
2	584	1,21
3	259	1,81
4	146	2,42
5	93	3,02



CRI ≥ 80 14W 36° 1550lm 3000K

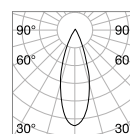

m	lx	Øm
1	2242	0,60
2	560	1,20
3	249	1,80
4	140	2,40
5	90	3,00



CRI ≥ 90 9W 36° 1100lm 3000K



Arca Accent

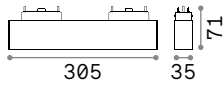

LED SMD OSRAM UGR <13

Potenza	Angolo	Lumen	CCT	Finitura		Codice	€
15W	35°	2000 lm	3000 K	Nero	■	222929	170
		2100 lm	4000 K	Nero	■	223001	170

0,440 Kg/0,0026 m³

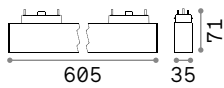

LED SMD OSRAM UGR <13

Potenza	Angolo	Lumen	CCT	Finitura		Codice	€
29W	35°	3650 lm	3000 K	Nero	■	222936	300
		3950 lm	4000 K	Nero	■	223018	300

0,700 Kg/0,0087 m³



Light beam: ACCENT

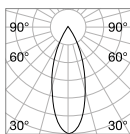

m	lx	Øm
1	2707	0,56
2	676	1,13
3	300	2,26
4	169	2,83
5	108	3,39



CRI≥90 15W 35° 2000lm 3000K

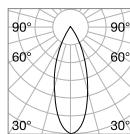

m	lx	Øm
1	4826	0,60
2	1207	1,21
3	536	1,81
4	301	2,42
5	193	3,02



CRI≥90 29W 35° 3650lm 3000K

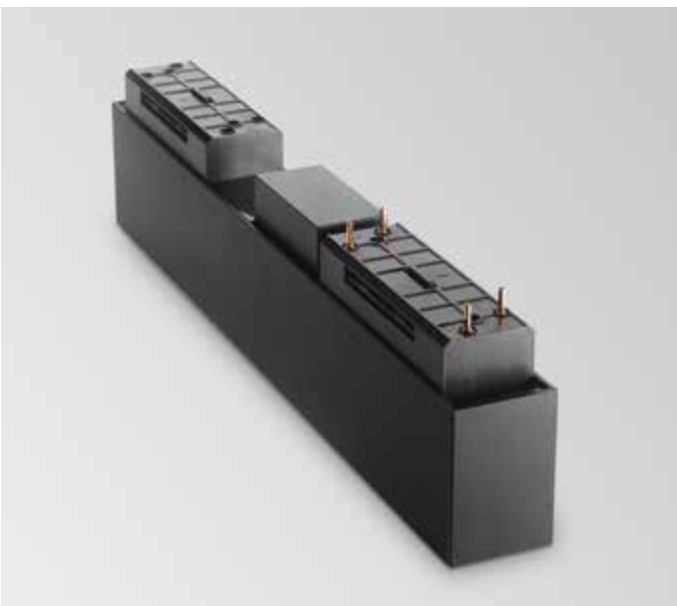

Arca Accent 300 mm



Arca Accent 600 mm



Arca Wide

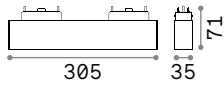

LED SMD SAMSUNG

Potenza	Angolo	Lumen	CCT	Finitura	Codice	€
13W	98°	1900 lm	3000 K	Nero	222943	105
		2000 lm	4000 K	Nero	223025	105

0,410 Kg/0,0025 m³

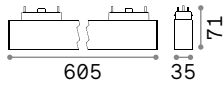
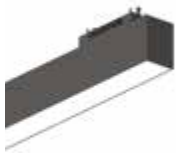

LED SMD SAMSUNG

Potenza	Angolo	Lumen	CCT	Finitura	Codice	€
25W	98°	3800 lm	3000 K	Nero	222950	152
		4050 lm	4000 K	Nero	223032	152

0,700 Kg/0,0087 m³



Light beam: WIDE

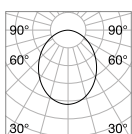

m	lx	Øm
1	203	2,16
2	50	4,33
3	22	6,50
4	12	8,66
5	8	10,83



CRI≥80 13W 98° 1900lm 3000K

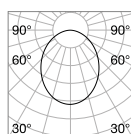

m	lx	Øm
1	440	2,14
2	110	4,28
3	48	6,42
4	27	8,56
5	17	10,70



CRI≥80 25W 98° 3800lm 3000K



Arca Wide 300 mm



Arca Wide 600 mm



Arca Pendant

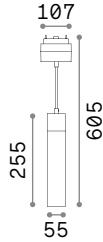

0,740 Kg/0,0056 m³

LED COB CITIZEN UGR <13

Potenza	Angolo	Lumen	CCT	Finitura		Codice	€
15 W	34°	1550 lm	3000 K	Nero	■	222981	180
		1650 lm	4000 K	Nero	■	223063	180

Lunghezza cavi 350 mm



LENS

Necessario	Angolo	Codice	€
No	18°	223285	8

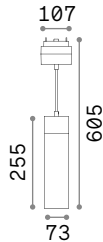

1,080 Kg/0,0056 m³

LED COB CITIZEN UGR <16

Potenza	Angolo	Lumen	CCT	Finitura		Codice	€
21 W	30°	2100 lm	3000 K	Nero	■	222998	200
		2150 lm	4000 K	Nero	■	223070	200

Lunghezza cavi 350 mm



LENS

Necessario	Angolo	Codice	€
No	15°	223292	8



Light beam: ACCENT

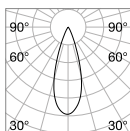

m	lx	cm
1	2410	0,59
2	602	1,19
3	268	1,78
4	151	2,38
5	96	2,98

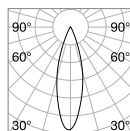

m	lx	cm
1	4788	0,51
2	1197	1,03
3	532	1,55
4	299	2,06
5	191	2,58



CRI≥80 15W 34° 1550lm 3000K

CRI≥80 21W 30° 2100lm 3000K



Arca - Suspension

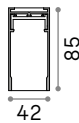
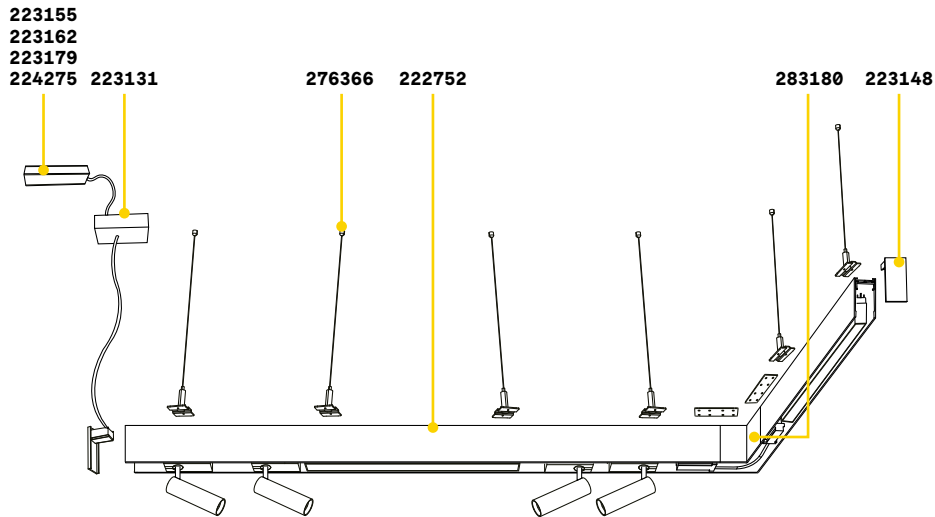

TRACK Lunghezza massima per punto di alimentazione: 25 metri

Lunghezza	Peso	Volume	Finitura	Codice	€
1000 mm	1,34 Kg	0,0273 m ³	Nero	222745	120
3000 mm	4,02 Kg	0,0496 m ³	Nero	222752	325

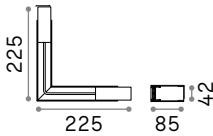

BLINDED CORNER RIGHT - LEFT Optional

Peso	Volume	Finitura	Codice	€
0,79 Kg	0,0090 m ³	Nero	283180	130



	Necessario	Lunghezza cavi	Misura (L x H x P)	Codice	€
LINEAR CONNECTOR	SI - 1 Kit x giunzione		100 x 18 x 38 mm	254944	25
ELECTRIFIED END CAP	SI - 1 kit x punto di alimentaz. max 210W	2150 mm	100 x 2270 x 53 mm	223131	45
END CAP	SI		20 x 85 x 42 mm	223148	18
SINGLE CABLE KIT	SI - 1 Kit x 1000 mm	2000 mm	ø 15 x 2000 mm	276366	14

Arca - Surface

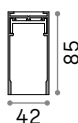
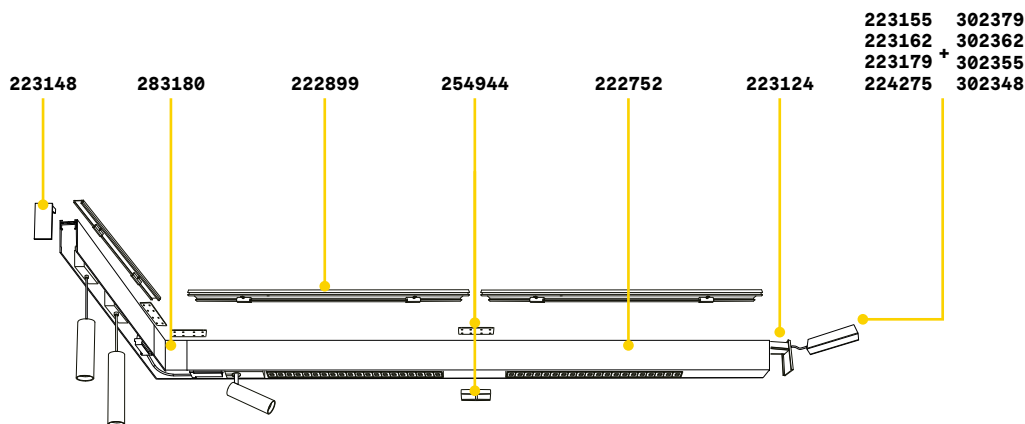

TRACK Lunghezza massima per punto di alimentazione: 25 metri

Lunghezza	Peso	Volume	Finitura	Codice	€
1000 mm	1,34 Kg	0,0273 m ³	Nero	222745	120
3000 mm	4,02 Kg	0,0496 m ³	Nero	222752	325



BLINDED CORNER RIGHT - LEFT Optional

Peso	Volume	Finitura	Codice	€
0,79 Kg	0,0090 m ³	Nero	283180	130



LINEAR CONNECTOR

Necessario	Lunghezza cavi	Misura (L x H x P)	Codice	€
SI - 1 Kit x giunzione		100 x 18 x 38 mm	254944	25

ELECTRIFIED END CAP

SI - 1 kit x punto di alimentaz. max 210W	380 mm	86 x 80 x 42 mm	223124	24
---	--------	-----------------	--------	----

ENDCAP

SI		20 x 85 x 42 mm	223148	18
----	--	-----------------	--------	----

KIT SURFACE

SI - 1 Kit x 1000 mm		1000 x 12 x 42 mm	222899	30
----------------------	--	-------------------	--------	----

Arca - Recessed

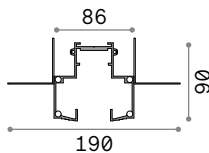
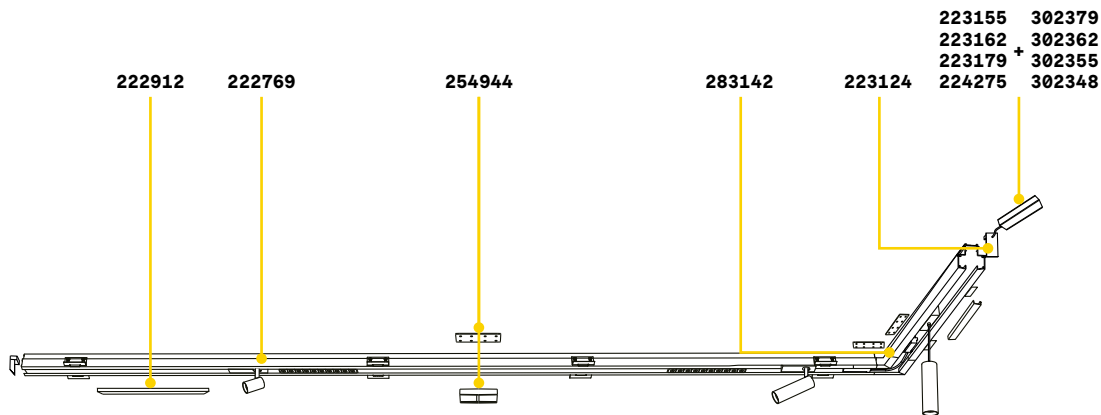

TRACK Kit per montaggio profilo e tappi di chiusura inclusi
Lunghezza massima per punto di alimentazione: 25 metri

Lunghezza	Peso	Volume	Finitura	Codice	€
1000 mm	2,90 Kg	0,0269 m ³	Nero	222769	187
3000 mm	8,70 Kg	0,0496 m ³	Nero	222882	490

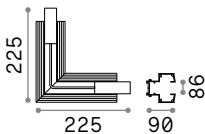

BLINDED CORNER RIGHT - LEFT Optional

Peso	Volume	Finitura	Codice	€
1,12 Kg	0,0090 m ³	Nero	283142	170



LINEAR CONNECTOR

Necessario	Lunghezza cavi	Misura (L x H x P)	Codice	€
SI - 1 Kit x giunzione		100 x 18 x 38 mm	254944	25
SI - 1 kit x punto di alimentaz. max 210W	380 mm	86 x 80 x 42 mm	223124	24

ELECTRIFIED END CAP



Arca - Drivers and cover

DRIVER MEANWELL ON/OFF Necessario



Potenza	Output	Classe	Misura (L x H x P)	Driver box	Codice	€
75 W	48 Vdc	⊕	17x37x62 mm	255x55x75 mm	223155	140
100 W	48 Vdc	⊕	220x37x68 mm	330x60x80 mm	223162	185
150 W	48 Vdc	⊕	228x37x68 mm	330x60x80 mm	223179	205
240 W	48 Vdc	⊕	244x39x68 mm	330x60x80 mm	224275	230

DRIVER BOX Optional



Materiale	Misura (L x H x P)	Colore	Codice	€
Metal	255x55x75 mm	Bianco	302379	25
		Nero	302362	25
	330x60x80 mm	Bianco	302355	30
		Nero	302348	30

BLINDED COVER Optional



Materiale	Lunghezza	Colore	Codice	€
PC	990 mm	Nero	222912	8

Ego new

Sistema lineare composto da un profilo in alluminio estruso ed elementi di illuminazione a fissaggio magnetico con blocco meccanico di sicurezza. Il sistema è disponibile in colore nero opaco RAL 9005, bianco opaco RAL 9016 oppure ottone satinato anodizzato, nella modalità d'installazione a plafone o sospensione (LOW e HIGH), incasso senza bordo a scomparsa nel cartongesso (RECESSED), incasso rapido nel cartongesso (RECESSED EASY) o incasso con bordo per controsoffitti in cartongesso o a pannelli (RECESSED TRIM). Sezione ridotta del profilo larga 26 mm e alta 27 mm o 52 mm, disponibile in due lunghezze 1000 mm e 2000 mm. Possibilità di composizione con diversi moduli luminosi a seconda della disposizione desiderata, modificabile all'occorrenza: i moduli TRACK SINGLE, DOUBLE e FLAT SINGLE per un'illuminazione spot, il modulo ACCENT con controllo dell'abbagliamento (UGR < 19), il modulo PENDANT TUBE per un'illuminazione localizzata e i moduli WIDE o PENDANT BALL per un'illuminazione diffusa e uniforme. Tecnologia a LED integrati con temperatura di colore di 3000 K o 4000 K; elevata resa cromatica CRI ≥ 90 , protezione IP20, classe isolamento III, alimentazione in 48 Vdc, durata utile LED 50.000 h L70B50; sistema disponibile anche in versione dimmerabile 1-10V o DALI-2. Ideale per l'illuminazione di piccoli e grandi ambienti dove viene richiesta ampia flessibilità ed elevata qualità di illuminazione, ad esempio spazi MUSEALI, COMMERCIALI, RESIDENZIALI e RETAIL.

PRO

Prodotto ad alto contenuto tecnologico, elevata qualità dei materiali, destinato ad uso professionale.

UGR

Articolo con UGR < 19 (Accent, Pendant).

Sorgente	LED COB / SMD
Driver incluso	No
Driver disponibili	On/Off
Controllo	1-10V / DALI
MacAdam	SDCM 3
CCT	3000 K / 4000 K
CRI	≥ 90
UGR	< 19 (Accent, Pendant)
Durata LED	50.000h
Classe isolamento	III
IP	20
Materiale	Alluminio
Garanzia	5 anni



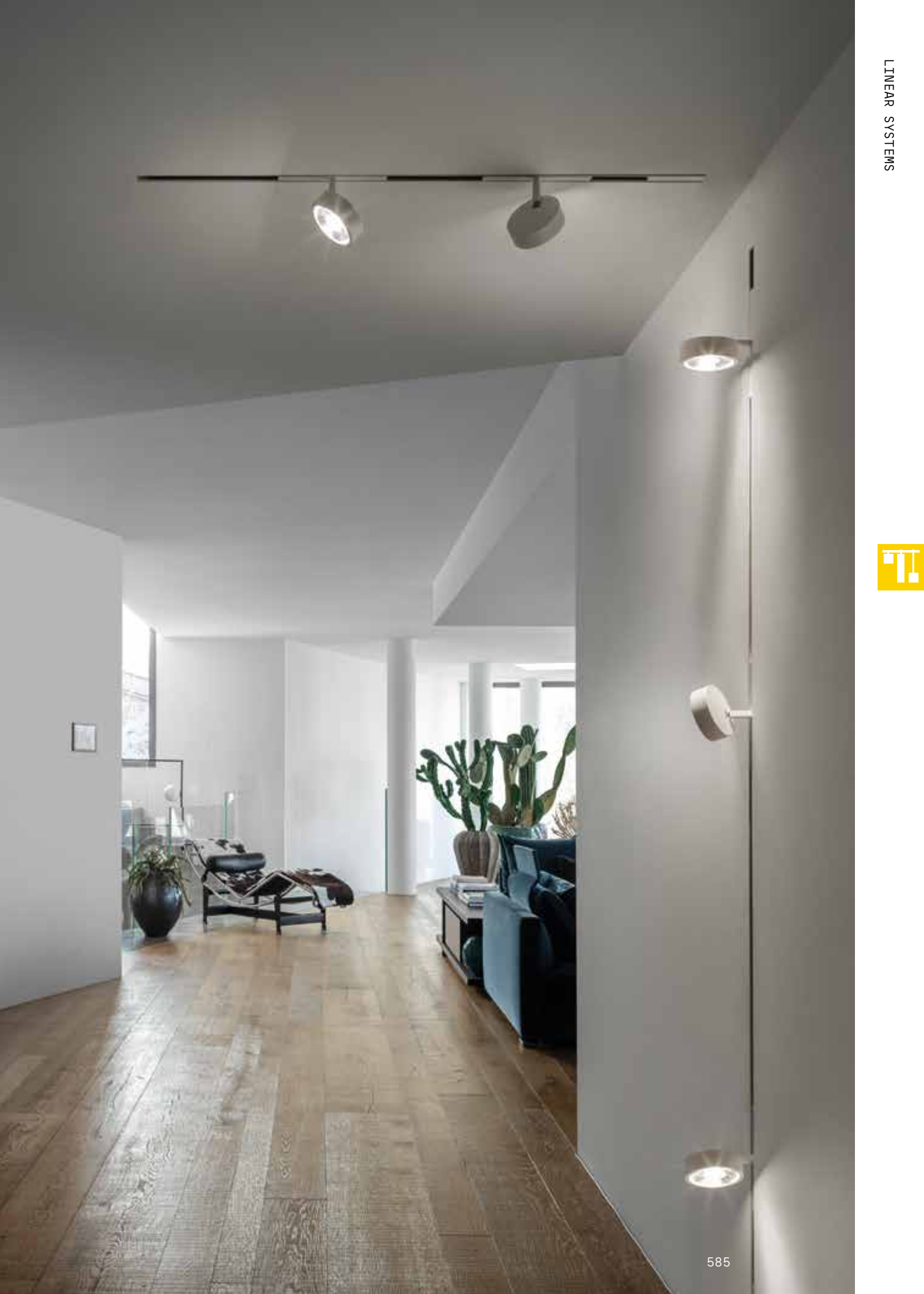

Ego Track Single



LED SMD OSRAM

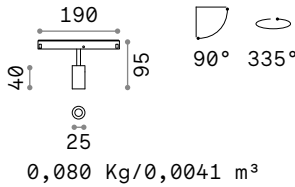

Potenza	Angolo	Controllo	Lumen	CCT	Finitura	Codice	€
3 W	30°	On-Off	200 lm	3000 K	Bianco	282978	85
					Nero	257617	85
					Ottone	282039	85
1-10V	30°	200 lm	3000 K	3000 K	Bianco	303673	120
					Nero	303666	120
					Nero	286396	140
DALI	30°	200 lm	3000 K	3000 K	Bianco	286402	140
					Nero	286396	140
					Nero	321912	140

LED COB CITIZEN

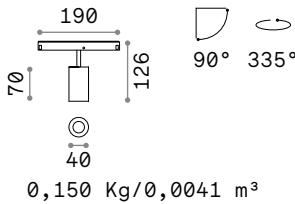

Potenza	Angolo	Controllo	Lumen	CCT	Finitura	Codice	€
8 W	30°	On-Off	850 lm	3000 K	Bianco	282985	107
					Nero	257631	107
					Ottone	282046	107
1-10V	30°	850 lm	3000 K	3000 K	Bianco	303697	130
					Nero	303680	130
					Nero	286419	160
DALI	30°	850 lm	3000 K	3000 K	Bianco	286426	160
					Nero	286419	160
					Nero	321936	160

LED COB CITIZEN

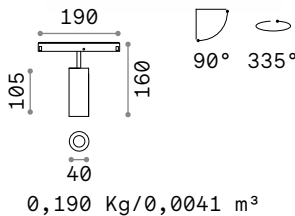

Potenza	Angolo	CCT	Lumen	Controllo	Finitura	Codice	€
12 W	30°	On-Off	1200 lm	3000 K	Bianco	282992	115
					Nero	257655	115
					Ottone	282053	115
1-10V	30°	1200 lm	3000 K	3000 K	Bianco	303710	135
					Nero	303703	135
					Nero	286433	165
DALI	30°	1200 lm	3000 K	3000 K	Bianco	286440	165
					Nero	286433	165
					Nero	321943	165

Modello	Necessario	Codice	€
Ego 3W	No	260853	5
Ego 8W	No	260860	5
Ego 12W	No	260860	5

FILTER HONEYCOMB



Light beam: ACCENT

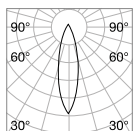

m	lx	øm
1	537	0,46
2	134	0,92
3	60	1,40
4	34	1,80
5	21	2,30



CRI≥90 3W 30° 190lm 3000K

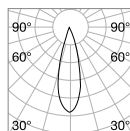

m	lx	øm
1	2393	0,49
2	598	0,98
3	266	1,50
4	150	2,00
5	96	2,50



CRI≥90 8W 30° 730lm 3000K

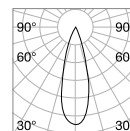

m	lx	øm
1	2877	0,51
2	719	1,00
3	320	1,50
4	180	2,10
5	115	2,60



CRI≥90 12W 30° 1000lm 3000K



Ego Track Single

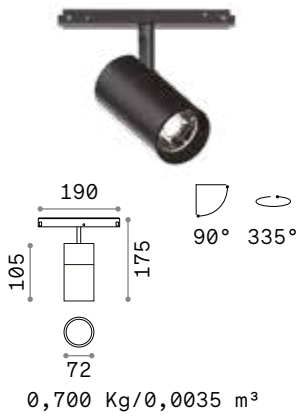

LED COB CITIZEN

Potenza	Angolo	Controllo	Lumen	CCT	Finitura	Codice	€		
19W	35°	On-Off	2200 lm	3000 K	Bianco	307558	175		
			2350 lm	4000 K	Nero	305608	175		
		1-10V	2200 lm	3000 K	Bianco	307527	195		
			2200 lm	3000 K	Nero	307510	195		
		DALI	2200 lm	3000 K	Bianco	307541	230		
			2350 lm	4000 K	Nero	307534	230		
					2350 lm	4000 K	Nero	321974	230 <i>new</i>

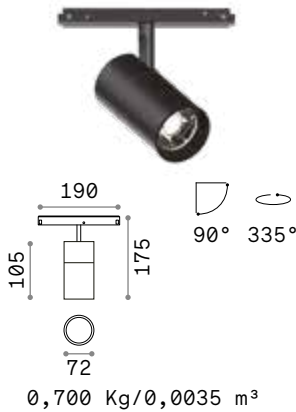

LED COB CITIZEN

Potenza	Angolo	Controllo	Lumen	CCT	Finitura	Codice	€		
26W	35°	On-Off	3050 lm	3000 K	Bianco	307602	180		
			3150 lm	4000 K	Nero	305615	180		
		1-10V	3050 lm	3000 K	Bianco	317991	180 <i>new</i>		
			3050 lm	3000 K	Nero	307572	200		
		DALI	3050 lm	3000 K	Bianco	307565	200		
			3050 lm	3000 K	Nero	307596	235		
					3150 lm	4000 K	Nero	307589	235
					3150 lm	4000 K	Nero	322001	235 <i>new</i>



Light beam: ACCENT

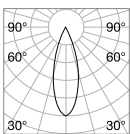

m	lx	Øm
1	4476	0,57
2	1119	1,10
3	497	1,70
4	280	2,30
5	179	2,90

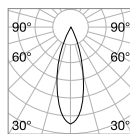

m	lx	Øm
1	6816	0,56
2	1704	1,10
3	757	1,70
4	426	2,20
5	273	2,80



CRI≥90 19W 35° 2200lm 3000K

CRI≥90 26W 35° 2950lm 3000K

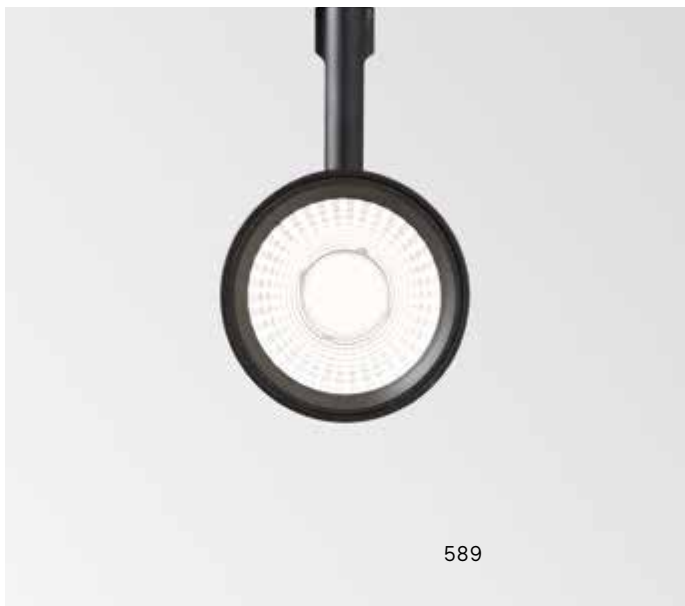

Ego Track Double

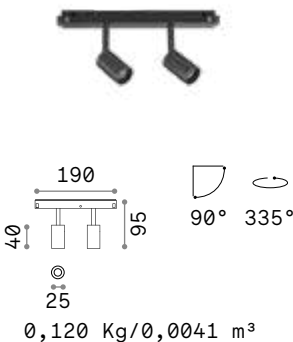

LED SMD OSRAM

Potenza	Angolo	Controllo	Lumen	CCT	Finitura	Codice	€	
5 W	30°	On-Off	400 lm	3000 K	Bianco	282947	120	
					Nero	257624	120	
					Ottone	282008	120	
			1-10V	430 lm	4000 K	Nero	321714	120 new
				400 lm	3000 K	Bianco	303611	145
				400 lm	3000 K	Nero	303604	145
		DALI	400 lm	3000 K	Bianco	286341	170	
			400 lm	3000 K	Nero	286334	170	
			430 lm	4000 K	Nero	321677	170 new	

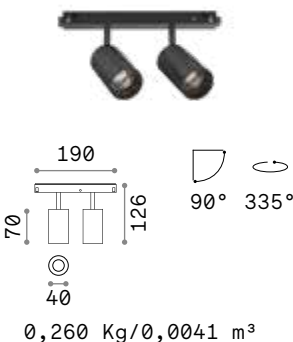

LED COB CITIZEN

Potenza	Angolo	Controllo	Lumen	CCT	Finitura	Codice	€	
16 W	30°	On-Off	1500 lm	3000 K	Bianco	282954	160	
					Nero	257648	160	
					Ottone	282015	160	
			1-10V	1550 lm	4000 K	Nero	321806	160 new
				1500 lm	3000 K	Bianco	303635	190
				1500 lm	3000 K	Nero	303628	190
		DALI	1500 lm	3000 K	Bianco	286365	210	
			1500 lm	3000 K	Nero	286358	210	
			1550 lm	4000 K	Nero	321721	210 new	

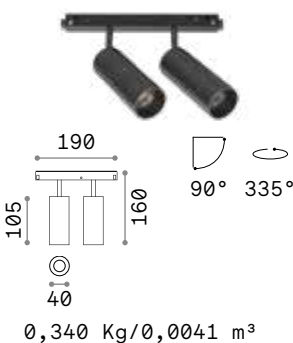

LED COB CITIZEN

Potenza	Angolo	Controllo	Lumen	CCT	Finitura	Codice	€	
24 W	30°	On-Off	2400 lm	3000 K	Bianco	282961	170	
					Nero	257662	170	
					Ottone	282022	170	
			1-10V	2500 lm	4000 K	Nero	321844	170 new
				2400 lm	3000 K	Bianco	303659	195
				2400 lm	3000 K	Nero	303642	195
		DALI	2400 lm	3000 K	Bianco	286389	220	
			2400 lm	3000 K	Nero	286372	220	
			2500 lm	4000 K	Nero	321899	220 new	



Light beam: ACCENT



FILTER HONEYCOMB

Modello	Necessario	Codice	€
Ego 5 W	No	260853	5
Ego 16 W	No	260860	5
Ego 24 W	No	260860	5

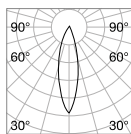

m	lx	øm
1	508	0,46
2	127	0,92
3	56	1,40
4	32	2,80
5	20	2,30

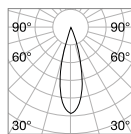

m	lx	øm
1	2451	0,49
2	613	1,98
3	272	1,50
4	153	2,00
5	98	2,50

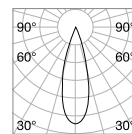

m	lx	øm
1	3051	0,51
2	763	1,00
3	339	1,50
4	191	2,10
5	122	2,60



CRI≥90 5W 30° 3801lm 3000K

CRI≥90 16W 30° 14501lm 3000K

CRI≥90 24W 30° 20001lm 3000K



Ego Track Big

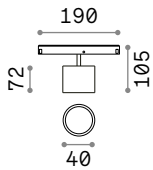

0,350 Kg/0,0035 m³

LED COB CITIZEN

Potenza	Angolo	Controllo	Lumen	CCT	Finitura	Codice	€
10 W	38°	On-Off	1000 lm	3000 K	Bianco	327556	140 <i>new</i>
					Nero	300764	140 <i>new</i>

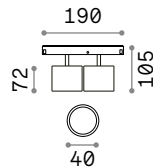

0,750 Kg/0,0026 m³

LED COB CITIZEN

Potenza	Angolo	Controllo	Lumen	CCT	Finitura	Codice	€
20 W	38°	On-Off	2000 lm	3000 K	Bianco	327549	240 <i>new</i>
					Nero	316307	240 <i>new</i>



Light beam: ACCENT

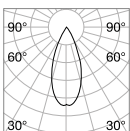

m	lx	Øm
1	1296	0,76
2	324	1,50
3	144	2,30
4	81	3,00
5	52	3,80

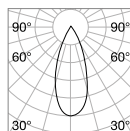

m	lx	Øm
1	2964	0,71
2	741	1,40
3	329	2,10
4	185	2,80
5	119	3,60



CRI≥90 10W 38° 1000lm 3000K

CRI≥90 20W 38° 2000lm 3000K



Ego Track Flat

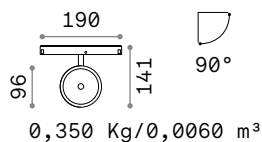

LED COB CITIZEN

Potenza	Angolo	Controllo	Lumen	CCT	Finitura	Codice	€
9W	36°	On-Off	1100 lm	3000 K	Bianco	300504	125
					Nero	290614	125
					Ottone	300511	125
		1-10V	1100 lm	3000 K	Bianco	303741	140
					Nero	303727	140
					Ottone	303734	140
		DALI	1100 lm	3000 K	Bianco	300535	175
					Nero	300528	175
					Ottone	300542	175



Light beam: ACCENT

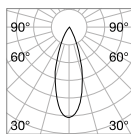

m	lx	Øm
1	2242	0,60
2	560	1,20
3	249	1,80
4	140	2,40
5	90	3,00



CRI≥90 9W 36° 1100lm 3000K



Ego Accent

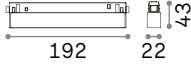

0,140 Kg/0,0013 m³

LED SMD OSRAM UGR <19

Potenza	Angolo	Controllo	Lumen	CCT	Finitura	Codice	€	
7W	35°	On-Off	700 lm	3000 K	Bianco	282633	115	
					Nero	257792	115	
		1-10V	730 lm	4000 K	Nero	323596	115	new
			700 lm	3000 K	Bianco	303505	155	
					Nero	303499	155	
			DALI	700 lm	3000 K	Bianco	286068	170
730 lm	4000 K	Nero		286051	170			
		Nero	321790	170	new			

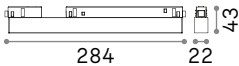

0,210 Kg/0,0019 m³

LED SMD OSRAM UGR <19

Potenza	Angolo	Controllo	Lumen	CCT	Finitura	Codice	€	
13W	35°	On-Off	1300 lm	3000 K	Bianco	282640	165	
					Nero	257686	165	
		1-10V	1350 lm	4000 K	Nero	317953	165	new
			1300 lm	3000 K	Bianco	303529	190	
					Nero	303512	190	
			DALI	1300 lm	3000 K	Bianco	286082	230
1350 lm	4000 K	Nero		286075	230			
		Nero	321820	230	new			



Light beam: ACCENT

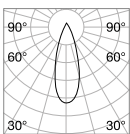

m	lx	Øm
1	3121	0,61
2	780	1,20
3	347	1,80
4	195	2,40
5	125	3,00



CRI≥90 13W 35° 1300lm 3000K



Ego Accent 192 mm



Ego Accent 284 mm



Ego Wide

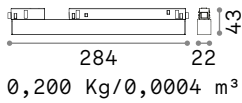

0,200 Kg/0,0004 m³

LED SMD SAMSUNG

Potenza	Angolo	Controllo	Lumen	CCT	Finitura	Codice	€
7W	110°	On-Off	850 lm	3000 K	Bianco	283029	85
					Nero	257709	85
1-10V	110°	On-Off	880 lm	4000 K	Nero	317960	85 <i>new</i>
			850 lm	3000 K	Bianco	303796	130
					Nero	303789	130
					Bianco	286501	145
					Nero	286495	145
					Nero	322025	145 <i>new</i>

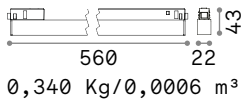

0,340 Kg/0,0006 m³

LED SMD SAMSUNG

Potenza	Angolo	Controllo	Lumen	CCT	Finitura	Codice	€
13W	110°	On-Off	1700 lm	3000 K	Bianco	283036	118
					Nero	257716	118
1-10V	110°	On-Off	1750 lm	4000 K	Nero	322056	118 <i>new</i>
			1700 lm	3000 K	Bianco	303819	165
					Nero	303802	165
					Bianco	286525	170
					Nero	286518	170
					Nero	322032	170 <i>new</i>

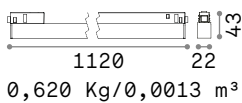

0,620 Kg/0,0013 m³

LED SMD SAMSUNG

Potenza	Angolo	Controllo	Lumen	CCT	Finitura	Codice	€
26W	110°	On-Off	3400 lm	3000 K	Bianco	283043	170
					Nero	257730	170
1-10V	110°	On-Off	3500 lm	4000 K	Nero	322070	170 <i>new</i>
			3400 lm	3000 K	Bianco	303833	200
					Nero	303826	200
					Bianco	286549	215
					Nero	286532	215
					Nero	322063	215 <i>new</i>



Light beam: WIDE

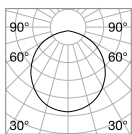

m	lx	Øm
1	619	2,50
2	155	4,90
3	69	7,40
4	39	9,80
5	25	12,00



CRI≥90 26W 110° 3300lm 3000K



Ego Wide 284 mm



Ego Wide 560 mm



Ego Wide 1120 mm



Ego Flexible

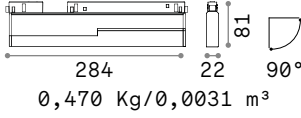

LED SMD OSRAM UGR <19

Potenza	Angolo	Lumen	CCT	Controllo	Finitura	Codice	€
13 W	35°	1300 lm	3000 K	On-Off	Bianco	282718	200
					Nero	257846	200
				1-10V	Bianco	303543	225
					Nero	303536	225
				DALI	Bianco	286105	250
					Nero	286099	250



LED SMD SAMSUNG

Potenza	Angolo	Lumen	CCT	Controllo	Finitura	Codice	€
7 W	110°	850 lm	3000 K	On-Off	Bianco	282725	135
					Nero	257839	135
				1-10V	Bianco	303567	165
					Nero	303550	165
				DALI	Bianco	286129	185
					Nero	286112	185



Light beam: ACCENT



Light beam: WIDE

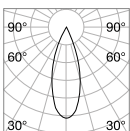

m	lx	cm
1	3112	0,61
2	778	1,20
3	346	1,80
4	194	2,40
5	124	3,00

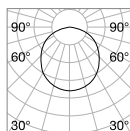

m	lx	cm
1	231	2,90
2	58	5,80
3	26	8,60
4	14	12,00
5	9	14,00



CRI≥90 13W 35° 1300lm 3000K

CRI≥90 7W 110° 850lm 3000K

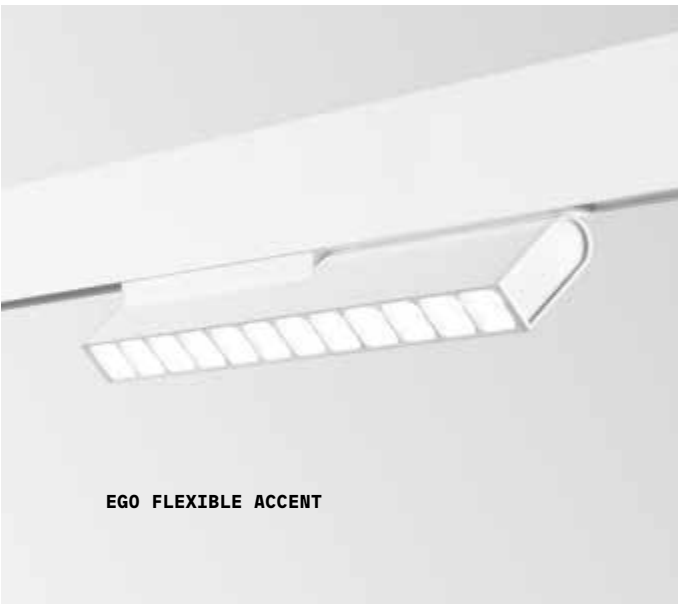

EGO FLEXIBLE ACCENT

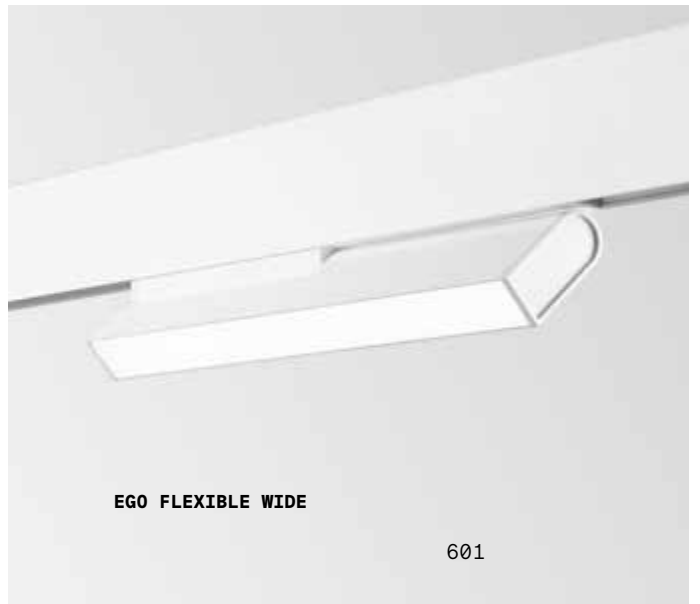

EGO FLEXIBLE WIDE

Ego Pendant

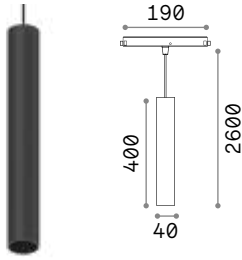

0,540 Kg/0,0038 m³

LED COB CITIZEN UGR <19

Potenza	Angolo	Controllo	Lumen	CCT	Finitura	Codice	€		
12W	30°	On-Off	1100 lm	3000 K	Bianco	282879	165		
					Nero	257747	165		
					Ottone	283852	165		
		1-10V	1150 lm	4000 K	Nero	321653	165	new	
			1100 lm	3000 K	Bianco	303598	200		
					Nero	303574	200		
	DALI			1100 lm	3000 K	Bianco	286327	215	
						Nero	286310	215	
						Ottone	300498	215	
				1150 lm	4000 K	Nero	321837	215	new

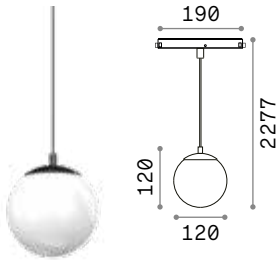

0,650 Kg/0,0125 m³

LED COB CITIZEN

Potenza	Angolo	Controllo	Lumen	CCT	Finitura	Codice	€	
10W	-	On-Off	1100 lm	3000 K	Bianco	327532	170	new
					Nero	327525	170	new



Light beam: ACCENT



Light beam: WIDE

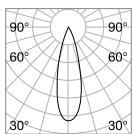

m	lx	Øm
1	2877	0,51
2	719	1,00
3	320	1,50
4	180	2,10
5	115	2,60

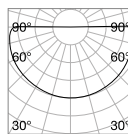

CRI≥90 12W 30° 1000lm 3000K

CRI≥90 10W 1100lm 3000K



Ego - Low



TRACK LOW Kit di montaggio non necessario, fissaggio diretto a soffitto
Lunghezza massima per punto di alimentazione: 25 metri

Lunghezza	Peso	Volume	Finitura	Codice	€
1000 mm	0,68 Kg	0,0013 m ³	Bianco	282909	57
			Nero	257877	57
2000 mm	1,36 Kg	0,0026 m ³	Bianco	282916	115
			Nero	266121	115

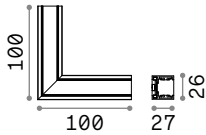

CONNECTOR HORIZONTAL LOW Optional

Peso	Volume	Controllo	Finitura	Codice	€	
0,07 Kg	0,0015 m ³	On-Off	Bianco	282848	95	
			Nero	257990	95	
			1-10V / DALI	Bianco	286266	100
			Nero	286259	100	

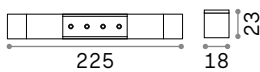

LINEAR CONNECTOR Necessario - 1 Kit x giunzione lineare

Peso	Volume	Controllo	Finitura	Codice	€	
0,16 Kg	0,0005 m ³	On-Off	Bianco	285993	50	
			Nero	283104	50	
			1-10V / DALI	Bianco	288338	55
			Nero	289281	55	

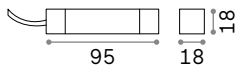

MAIN CONNECTOR Necessario - 1 Kit x punto di alimentaz. max 210W

Peso	Volume	Controllo	Finitura	Codice	€	
0,12 Kg	0,0005 m ³	On-Off	Bianco	282862	36	
			Nero	265896	36	
			1-10V / DALI	Bianco	286303	50
			Nero	286297	50	

Lunghezza cavo 2000 mm



END CAP NO HOLE



END CAP WITH HOLE



SUSPENSION KIT



KIT SINGLE CABLE

Necessario	Misura (L x H x P)	Finitura	Codice	€
SI	26 x 11 x 27 mm	Bianco	282688	6
		Nero	267241	6
SI	26 x 11 x 27 mm	Bianco	282671	6
		Nero	267258	6
SI - 1 kit x punto di alimentaz. max 210W	2000 mm	Bianco	282749	55
		Nero	276328	55
SI - 1 kit x 900 mm	2000 mm	Bianco	282756	17
		Nero	259376	17

Ego - Assembly plans

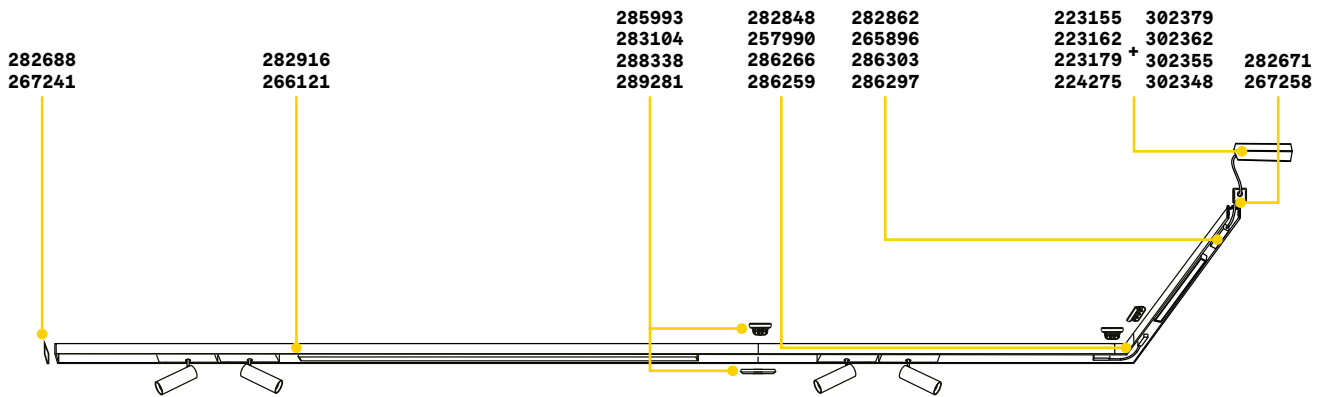
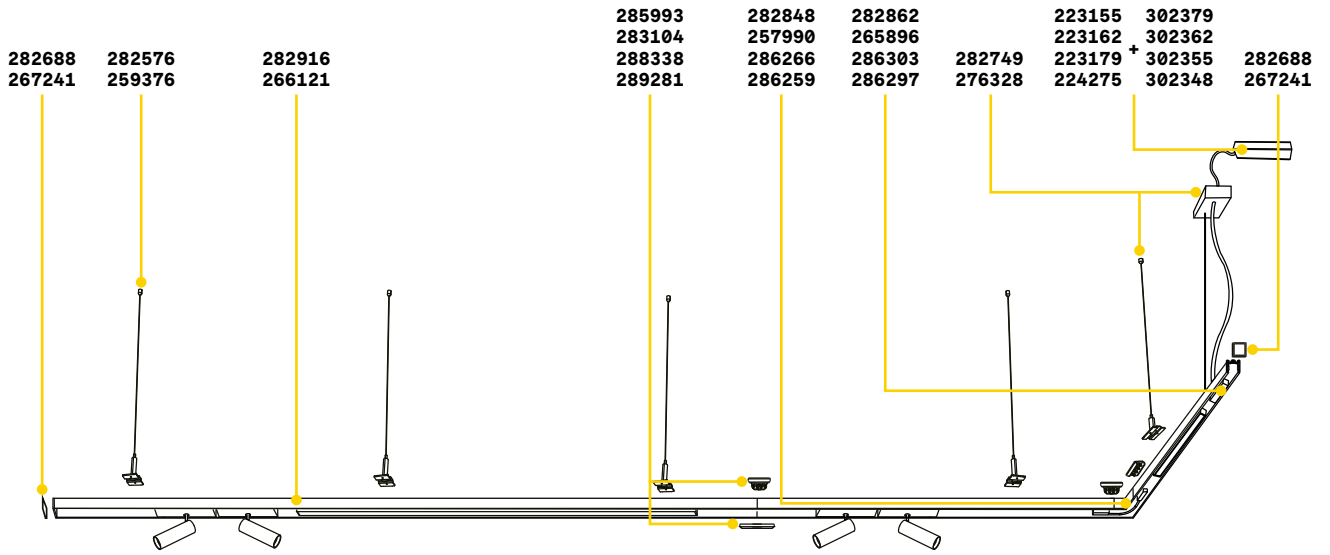

PROFILE LOW



Ego - High

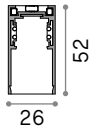

TRACK HIGH Kit di montaggio non necessario, fissaggio diretto a soffitto
Lunghezza massima per punto di alimentazione: 25 metri

Lunghezza	Peso	Volume	Finitura	Codice	€
1000 mm	0,80 Kg	0,0023 m ³	Bianco	282886	62
			Nero	258027	62
2000 mm	1,60 Kg	0,0046 m ³	Bianco	282893	125
			Nero	266145	125

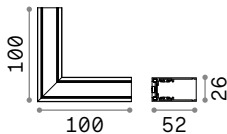

CONNECTOR HORIZONTAL HIGH Optional

Peso	Volume	Controllo	Finitura	Codice	€
0,10 Kg	0,0015 m ³	On-Off	Bianco	282824	90
			Nero	258140	90
		1-10V / DALI	Bianco	286228	100
			Nero	286211	100

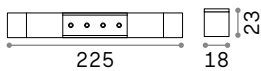

LINEAR CONNECTOR Necessario - 1 Kit x giunzione lineare

Peso	Volume	Controllo	Finitura	Codice	€
0,16 Kg	0,0005 m ³	On-Off	Bianco	285993	50
			Nero	283104	50
		1-10V / DALI	Bianco	288338	55
			Nero	289281	55

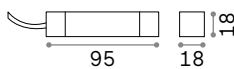

MAIN CONNECTOR Necessario - 1 Kit x punto di alimentaz. max 210W

Lunghezza cavo 2000 mm

Peso	Volume	Controllo	Finitura	Codice	€
0,12 Kg	0,0005 m ³	On-Off	Bianco	282862	36
			Nero	265896	36
		1-10V / DALI	Bianco	286303	50
			Nero	286297	50



END CAP NO HOLE

END CAP WITH HOLE

SUSPENSION KIT

KIT SINGLE CABLE

BLINDED COVER

Necessario	Misura (L x H x P)	Finitura	Codice	€
SI	26 x 11 x 52 mm	Bianco	282664	6
		Nero	267227	6
SI	26 x 11 x 52 mm	Bianco	282657	6
		Nero	267234	6
SI - 1 kit x punto di alimentaz. max 210W	2000 mm	Bianco	282749	55
		Nero	276328	55
SI - 1 kit x 900 mm	2000 mm	Bianco	282756	17
		Nero	259376	17
No	1000 x 5 x 24 mm	Bianco	282770	17
		Nero	258256	17

Ego - Assembly plans

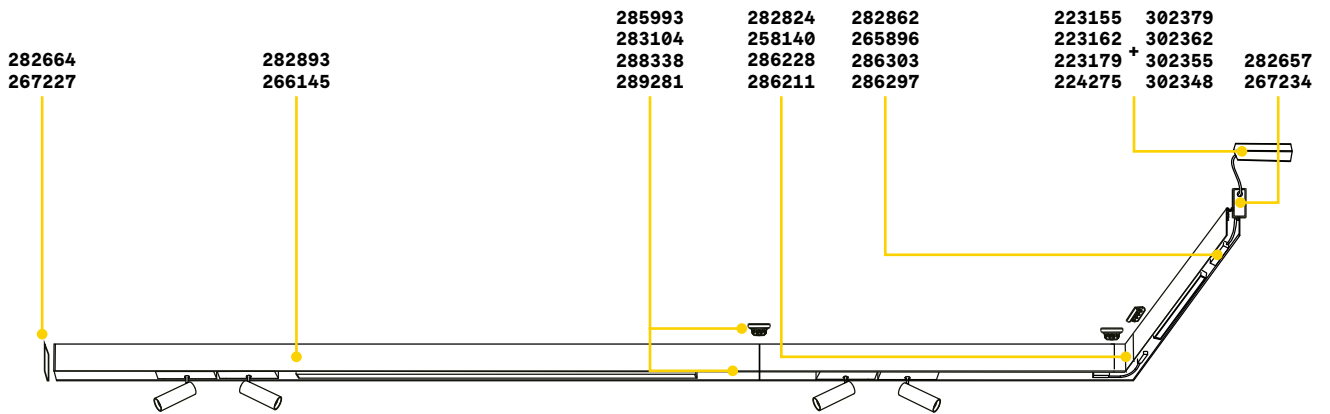
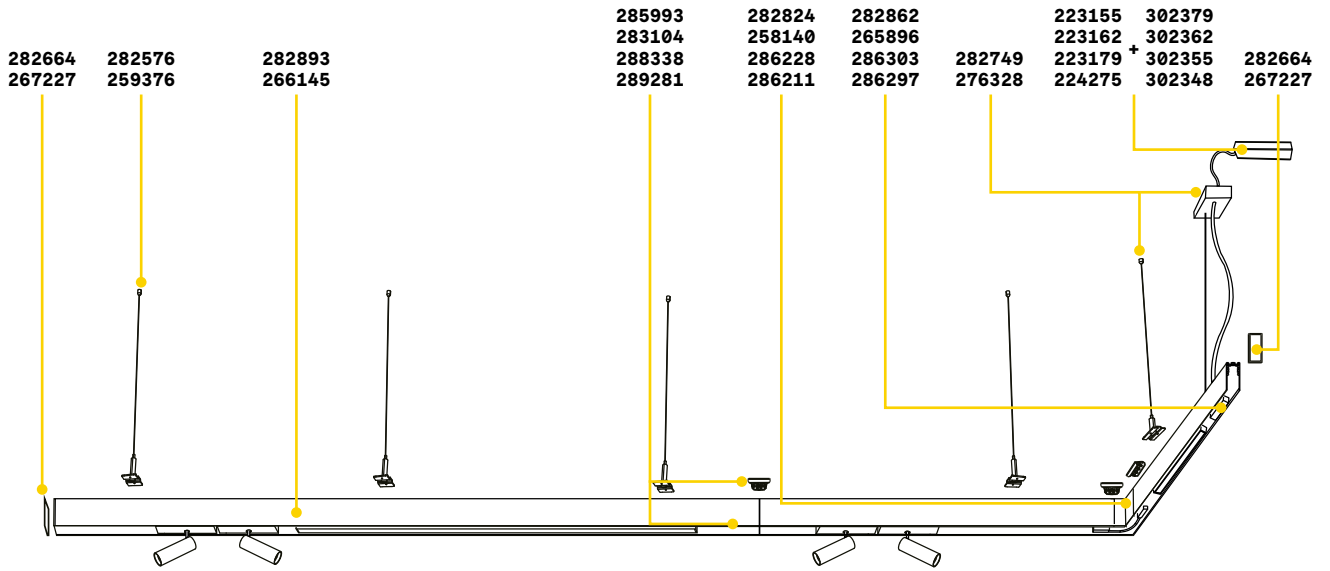

PROFILE HIGH



Ego - Recessed

TRACK Kit per montaggio profilo incluso

Lunghezza massima per punto di alimentazione: 25 metri

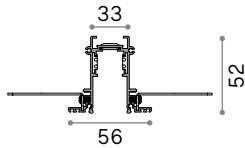

Lunghezza	Peso	Volume	Finitura	Codice	€
1000 mm	1,13 Kg	0,0039 m ³	Bianco	282923	71
			Nero	258171	71
2000 mm	2,26 Kg	0,0078 m ³	Bianco	282930	150
			Nero	266183	150

CONNECTOR HORIZONTAL Optional

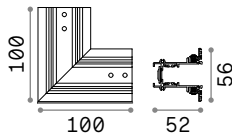

Peso	Volume	Controllo	Finitura	Codice	€
0,13 Kg	0,0015 m ³	On-Off	Bianco	282787	90
			Nero	258232	90
		1-10V / DALI	Bianco	286204	125
			Nero	286167	125

LINEARCONNECTOR Necessario - 1 Kit x giunzione lineare

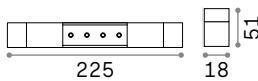

Peso	Volume	Controllo	Finitura	Codice	€
0,16 Kg	0,0005 m ³	On-Off	Bianco	286006	50
			Nero	283111	50
		1-10V / DALI	Bianco	289298	55
			Nero	289304	55

MAIN CONNECTOR Necessario - 1 Kit x punto di alimentaz. max 210W

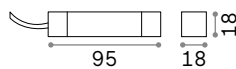

Lunghezza cavo 2000 mm

Peso	Volume	Controllo	Finitura	Codice	€
0,12 Kg	0,0005 m ³	On-Off	Bianco	282862	36
			Nero	265896	36
		1-10V / DALI	Bianco	286303	50
			Nero	286297	50



END CAP NO HOLE

END CAP WITH HOLE

BLINDED COVER

INSTALLATION TOOL

Necessario	Misura (L x H x P)	Finitura	Codice	€
SI	36 x 4 x 52 mm	Bianco	282701	5
		Nero	267203	5
SI	36 x 4 x 52 mm	Bianco	282695	6
		Nero	267210	6
No	1000 x 5 x 24 mm	Bianco	282770	17
		Nero	258256	17
No		Nero	292922	31

Ego - Assembly plans

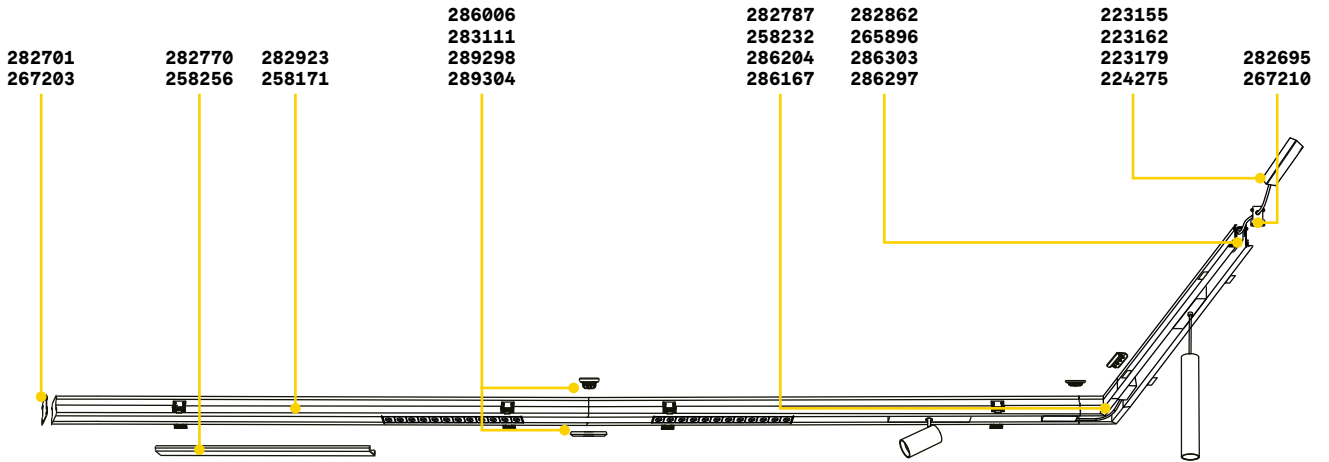

BLINDED COVER



RECESSED INSTALLATION TOOL



Ego - Recessed Easy

TRACK Kit di montaggio non necessario, fissaggio diretto a soffitto
Lunghezza massima per punto di alimentazione: 25 metri

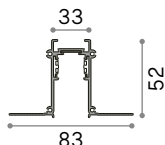

Lunghezza	Peso	Volume	Finitura	Codice	€
1000 mm	1,16 Kg	0,0058 m ³	Bianco	320489	85 <i>new</i>
			Nero	320472	85 <i>new</i>
2000 mm	2,40 Kg	0,0122 m ³	Bianco	320502	170 <i>new</i>
			Nero	320496	170 <i>new</i>

CONNECTOR HORIZONTAL Optional

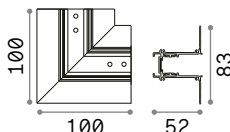

Peso	Volume	Controllo	Finitura	Codice	€
0,30 Kg	0,0010 m ³	On-Off	Bianco	320748	115 <i>new</i>
			Nero	320731	115 <i>new</i>
		1-10V / DALI	Bianco	320724	135 <i>new</i>
			Nero	320717	135 <i>new</i>

LINEARCONNECTOR Necessario - 1 Kit x giunzione lineare

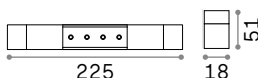

Peso	Volume	Controllo	Finitura	Codice	€
0,16 Kg	0,0005 m ³	On-Off	Bianco	286006	50
			Nero	283111	50
		1-10V / DALI	Bianco	289298	55
			Nero	289304	55

MAIN CONNECTOR Necessario - 1 Kit x punto di alimentaz. max 210W

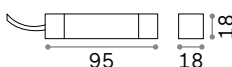

Lunghezza cavo 2000 mm

Peso	Volume	Controllo	Finitura	Codice	€
0,12 Kg	0,0005 m ³	On-Off	Bianco	282862	36
			Nero	265896	36
		1-10V / DALI	Bianco	286303	50
			Nero	286297	50



END CAP NO HOLE

END CAP WITH HOLE

BLINDED COVER

Necessario	Misura (L x H x P)	Finitura	Codice	€
SI	83 x 52 x 30 mm	Bianco	320564	8 <i>new</i>
		Nero	320557	8 <i>new</i>
SI	83 x 52 x 30 mm	Bianco	320588	10 <i>new</i>
		Nero	320571	10 <i>new</i>
No	1000 x 5 x 24 mm	Bianco	282770	17
		Nero	258256	17

Ego - Assembly plans

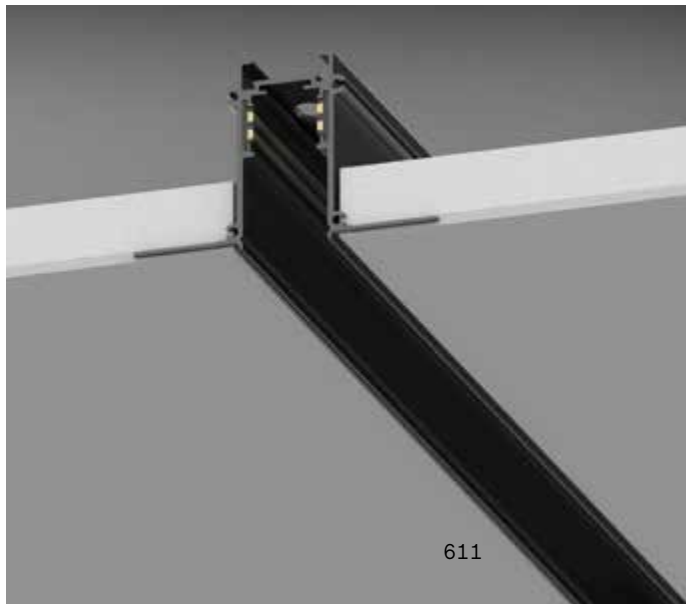
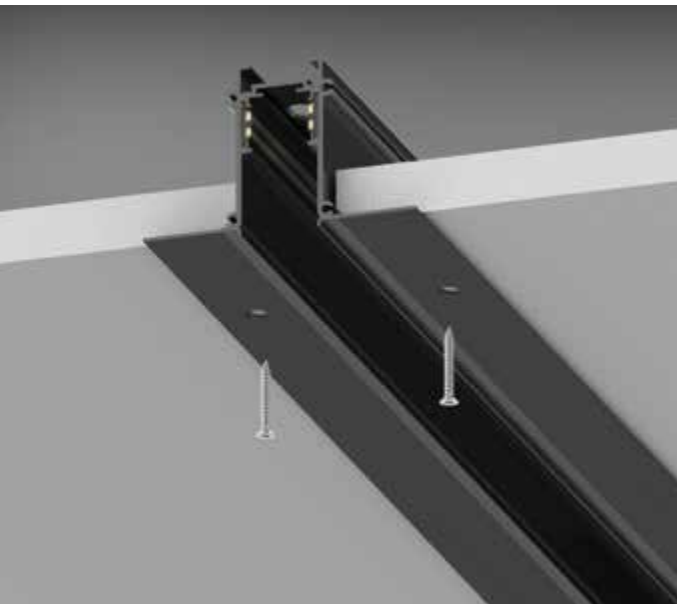
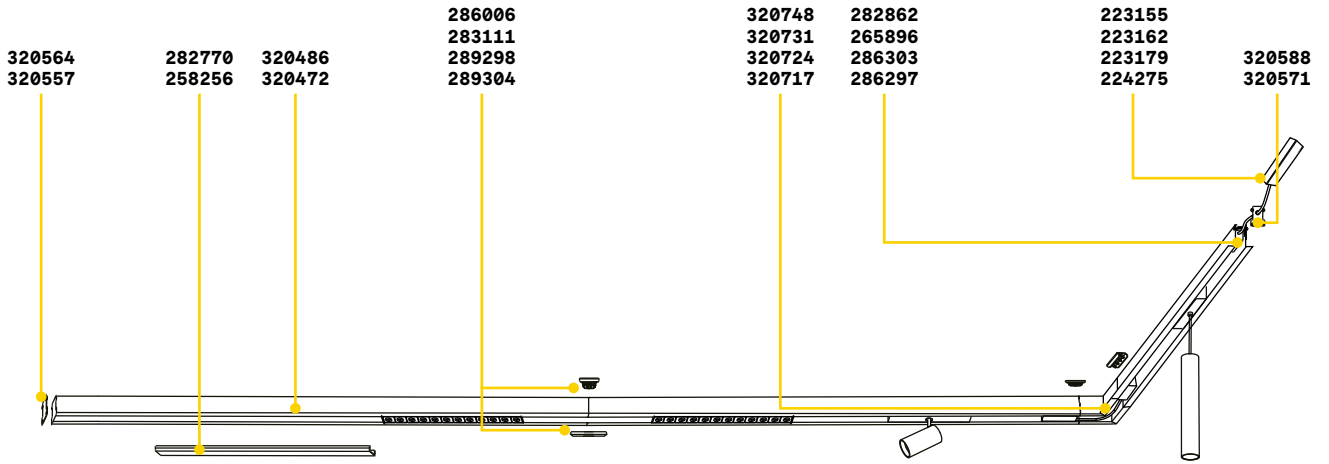

Ego - Recessed Trim

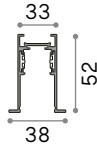

TRACK Kit per montaggio profilo incluso

Lunghezza massima per punto di alimentazione: 25 metri

Lunghezza	Peso	Volume	Finitura	Codice	€
1000 mm	1,13 Kg	0,0058 m ³	Bianco	320441	85 <small>new</small>
			Nero	320434	85 <small>new</small>
2000 mm	2,25 Kg	0,0122 m ³	Bianco	320465	170 <small>new</small>
			Nero	320458	170 <small>new</small>

CONNECTOR HORIZONTAL Optional

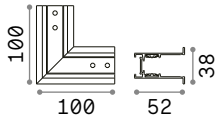

Peso	Volume	Controllo	Finitura	Codice	€
0,30 Kg	0,0010 m ³	On-Off	Bianco	320625	125 <small>new</small>
			Nero	320618	125 <small>new</small>
		1-10V / DALI	Bianco	320601	145 <small>new</small>
			Nero	320595	145 <small>new</small>

LINEARCONNECTOR Necessario - 1 Kit x giunzione lineare

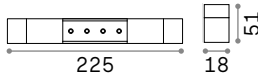

Peso	Volume	Controllo	Finitura	Codice	€
0,16 Kg	0,0005 m ³	On-Off	Bianco	286006	50
			Nero	283111	50
		1-10V / DALI	Bianco	289298	55
			Nero	289304	55

MAIN CONNECTOR Necessario - 1 Kit x punto di alimentaz. max 210W

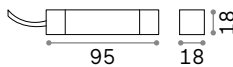

Lunghezza cavo 2000 mm

Peso	Volume	Controllo	Finitura	Codice	€
0,12 Kg	0,0005 m ³	On-Off	Bianco	282862	36
			Nero	265896	36
		1-10V / DALI	Bianco	286303	50
			Nero	286297	50

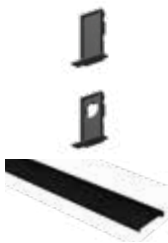

END CAP NO HOLE

END CAP WITH HOLE

BLINDED COVER

Necessario	Misura (L x H x P)	Finitura	Codice	€
SI	38 x 52 x 17 mm	Bianco	320526	6 <small>new</small>
		Nero	320519	6 <small>new</small>
SI	38 x 52 x 17 mm	Bianco	320540	9 <small>new</small>
		Nero	320533	9 <small>new</small>
No	1000 x 5 x 24 mm	Bianco	282770	17
		Nero	258256	17

Ego - Assembly plans

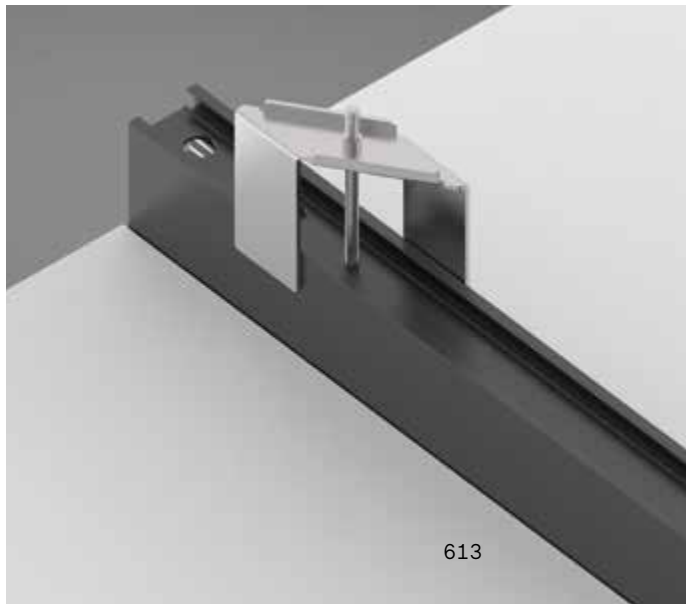
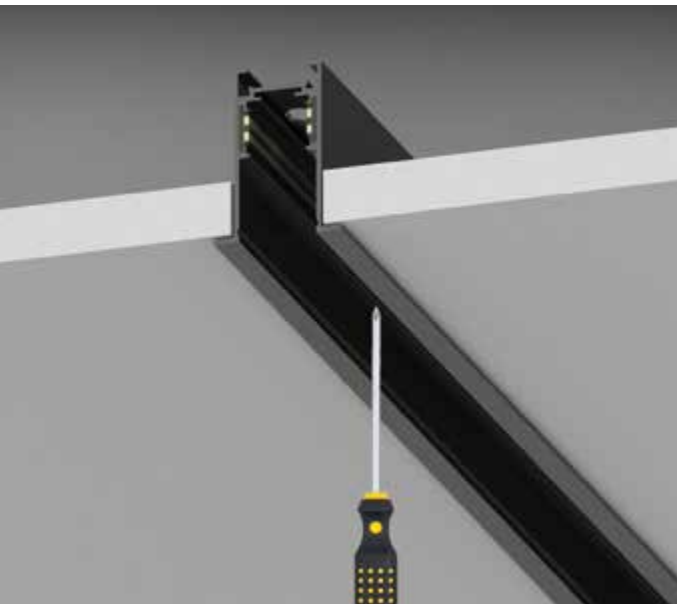
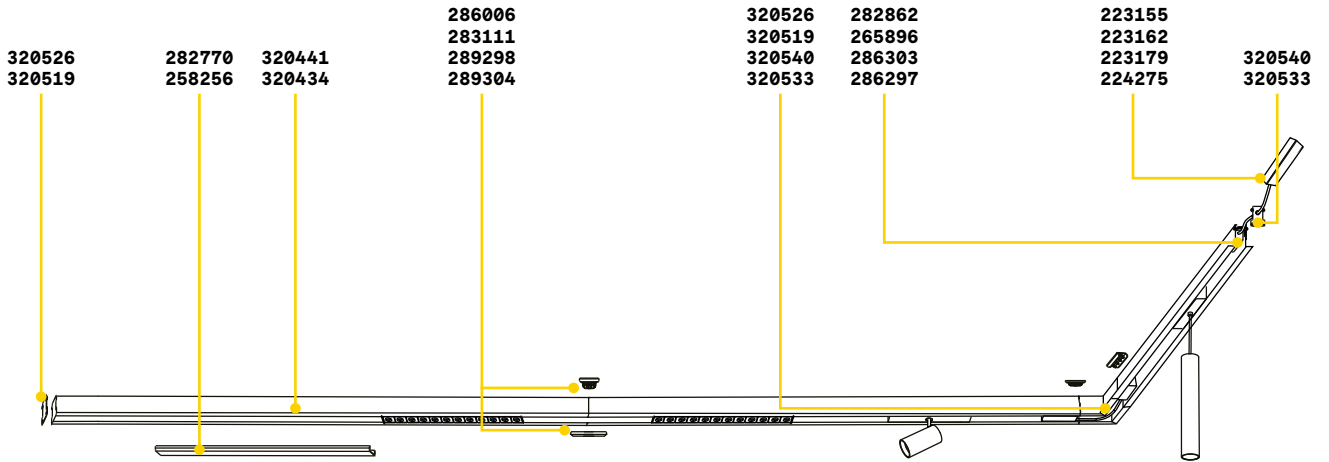

Ego - Drivers



DRIVER MEANWELL ON/OFF Necessario

Potenza	Output	Classe	Misura (L x H x P)	Driver box	Codice	€
75 W	48 Vdc	⊕	171x37x62 mm	255x55x75 mm	223155	140
100 W	48 Vdc	⊕	220x37x68 mm	330x60x80 mm	223162	185
150 W	48 Vdc	⊕	228x37x68 mm	330x60x80 mm	223179	205
240 W	48 Vdc	⊕	244x39x68 mm	330x60x80 mm	224275	230



DRIVER BOX Optional

Materiale	Misura (L x H x P)	Colore	Codice	€
Metal	255x55x75 mm	Bianco	302379	25
		Nero	302362	25
	330x60x80 mm	Bianco	302355	30
		Nero	302348	30



MAGNETIC DRIVER Necessario - Lunghezza cavo 2000 mm Sostituisce Driver + Main Connector*

Potenza	Output	Classe	Misura (L x H x P)	Codice	€
100 W	48 Vdc	□	297x20x16 mm	296302	90
150 W	48 Vdc	□	268x43x16 mm	325750	95 <small>new</small>
200 W	48 Vdc	□	268x43x16 mm	325767	110 <small>new</small>

* Codici **325750** e **325767** consigliati per l'impiego nelle versioni HIGH e RECESSED.



Stick ^{new}

Sistema lineare dimmerabile composto da un profilo in alluminio estruso ed elementi di illuminazione a fissaggio magnetico. Il sistema è disponibile in colore nero opaco nella modalità d'installazione a plafone (SURFACE) o incasso a scomparsa nel cartongesso (RECESSED). Sezione ridotta del profilo larga 19 mm e alta soltanto 13.5 mm, disponibile in due lunghezze 1000 mm e 2000 mm. Possibilità di composizione con diversi moduli luminosi a seconda della disposizione desiderata, modificabile all'occorrenza: i moduli TRACK SINGLE e DOUBLE per un'illuminazione spot, i moduli ACCENT per una luce focalizzata e i moduli WIDE per un'illuminazione diffusa e uniforme. Tecnologia a LED integrati con temperatura di colore di 3000 K; elevata resa cromatica CRI ≥ 90 , protezione IP20, classe isolamento III, alimentazione in 48 Vdc, durata utile LED 30.000 h L70B50; sistema disponibile anche in versione dimmerabile 1-10V. Ideale per l'illuminazione di dettagli o piccoli ambienti dove viene richiesta ampia flessibilità ed elevata qualità di illuminazione, ad esempio spazi MUSEALI, RESIDENZIALI e RETAIL.

Sorgente	LED COB / SMD
Driver incluso	No
Driver disponibili	On/Off / 1-10V
Controllo	Phase-cut
CCT	3000 K
CRI	≥ 90
Durata LED	30.000h
Classe isolamento	III
IP	20
Materiale	Alluminio
Garanzia	5 anni





Stick Track Single

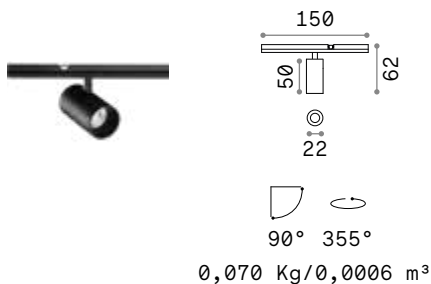
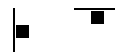

LED COB BRIDGLEUX

Potenza	Angolo	Lumen	CCT	Finitura	Codice	€
3W	24°	270 lm	3000 K	Nero	329505	40 <small>new</small>

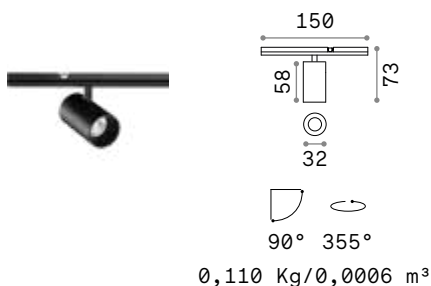

LED COB BRIDGLEUX

Potenza	Angolo	Lumen	CCT	Finitura	Codice	€
5W	30°	470 lm	3000 K	Nero	329529	45 <small>new</small>



Light beam: ACCENT

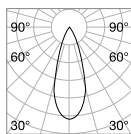

m	lx	Øm
1	514	0,62
2	128	1,20
3	57	1,90
4	32	2,50
5	21	3,10



CRI≥90 3W 24° 270lm 3000K

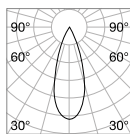

m	lx	Øm
1	822	0,62
2	205	1,20
3	91	1,90
4	51	2,50
5	33	3,10



CRI≥90 5W 30° 470lm 3000K



Stick Track Double

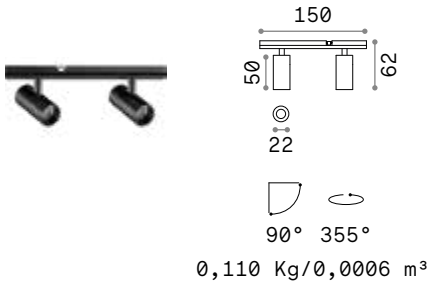

LED COB BRIDGLEUX

Potenza	Angolo	Lumen	CCT	Finitura	Codice	€
6W	24°	550 lm	3000 K	Nero	329512	65 <small>new</small>

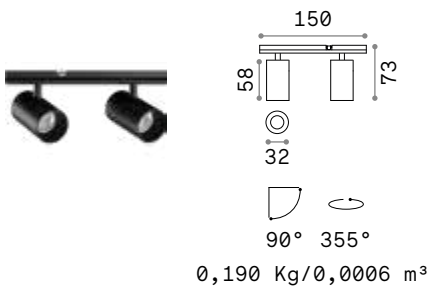

LED COB BRIDGLEUX

Potenza	Angolo	Lumen	CCT	Finitura	Codice	€
10W	30°	950 lm	3000 K	Nero	329536	70 <small>new</small>



Light beam: ACCENT

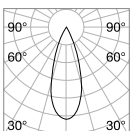

m	lx	Øm
1	1028	0,62
2	257	1,20
3	114	1,90
4	64	2,50
5	41	3,10



CRI≥90 6W 24° 550lm 3000K

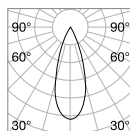

m	lx	Øm
1	1645	0,62
2	411	1,20
3	183	1,90
4	103	2,50
5	66	3,10



CRI≥90 10W 30° 950lm 3000K



Stick Accent



LED SMD BRIDGLEUX

Potenza	Angolo	Lumen	CCT	Finitura	Codice	€
6W	40°	600 lm	3000 K	Nero	329468	30 <small>new</small>

0,070 Kg/0,0001 m³



LED SMD BRIDGLEUX

Potenza	Angolo	Lumen	CCT	Finitura	Codice	€
12W	40°	1200 lm	3000 K	Nero	329475	60 <small>new</small>

0,150 Kg/0,0002 m³



Light beam: ACCENT

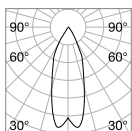

m	lx	Øm
1	958	0,64
2	240	1,30
3	106	1,90
4	60	2,60
5	38	3,20



CRI≥90 6W 40° 600lm 3000K

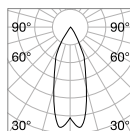

m	lx	Øm
1	1917	0,64
2	479	1,30
3	213	1,90
4	120	2,60
5	77	3,20



CRI≥90 12W 40° 1200lm 3000K



Stick Accent 300 mm



Stick Accent 600 mm



Stick Wide



LED SMD BRIDGLEUX

Potenza	Angolo	Lumen	CCT	Finitura	Codice	€
6W	110°	600 lm	3000 K	Nero	329444	25 <small>new</small>

0,070 Kg/0,0001 m³



LED SMD BRIDGLEUX

Potenza	Angolo	Lumen	CCT	Finitura	Codice	€
12W	110°	1200 lm	3000 K	Nero	329451	50 <small>new</small>

0,130 Kg/0,0002 m³



Light beam: WIDE

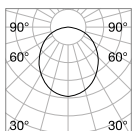

m	lx	Øm
1	138	2,50
2	35	4,90
3	15	7,40
4	8,7	9,80
5	5,5	12,00



CRI≥90 6W 110° 600lm 3000K

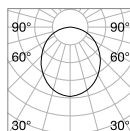

m	lx	Øm
1	277	2,50
2	69	4,90
3	31	7,40
4	17	9,80
5	11	12,00



CRI≥90 12W 110° 1200lm 3000K



Stick Wide 300 mm



Stick Wide 600 mm



Stick Surface

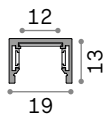

TRACK Kit per montaggio profilo e tappi di chiusura inclusi

Lunghezza	Peso	Volume	Finitura	Codice	€
1000 mm	0,350 Kg	0,0594 m ³	Nero	329574	30 <i>new</i>
2000 mm	0,700 Kg	0,1154 m ³	Nero	329581	60 <i>new</i>

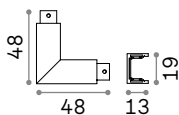

CONNECTOR HORIZONTAL Optional

Peso	Volume	Finitura	Codice	€
0,10 Kg	0,0015 m ³	Nero	330358	47 <i>new</i>



BLINDED COVER

Necessario	Misura (L x H x P)	Finitura	Codice	€
No	1000 x 3 x 16 mm	Nero	329635	5 <i>new</i>
	2000 x 3 x 16 mm	Nero	329642	8 <i>new</i>

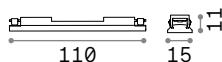

LINEAR CONNECTOR Necessario - 1 Kit x giunzione lineare

Peso	Volume	Finitura	Codice	€
0,03 Kg	0,0001 m ³	Nero	329710	18 <i>new</i>

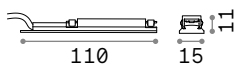

MAIN CONNECTOR Necessario - 1 Kit x punto di alimentazione

Peso	Volume	Finitura	Codice	€
0,08 Kg	0,0003 m ³	Nero	329703	24 <i>new</i>

DRIVER 1-10V Necessario



Potenza	Output	Classe	Misura (L x H x P)	Codice	€
150 W	48 Vdc	□	350x18x30 mm	329673	115 <i>new</i>

POWER SUPPLY LINEAR Necessario
Sostituisce Driver + Main Connector



Potenza	Output	Classe	Misura (L x H x P)	Codice	€
120 W	48 Vdc	□	304x32x16 mm	329666	100 <i>new</i>

Stick - Assembly plans

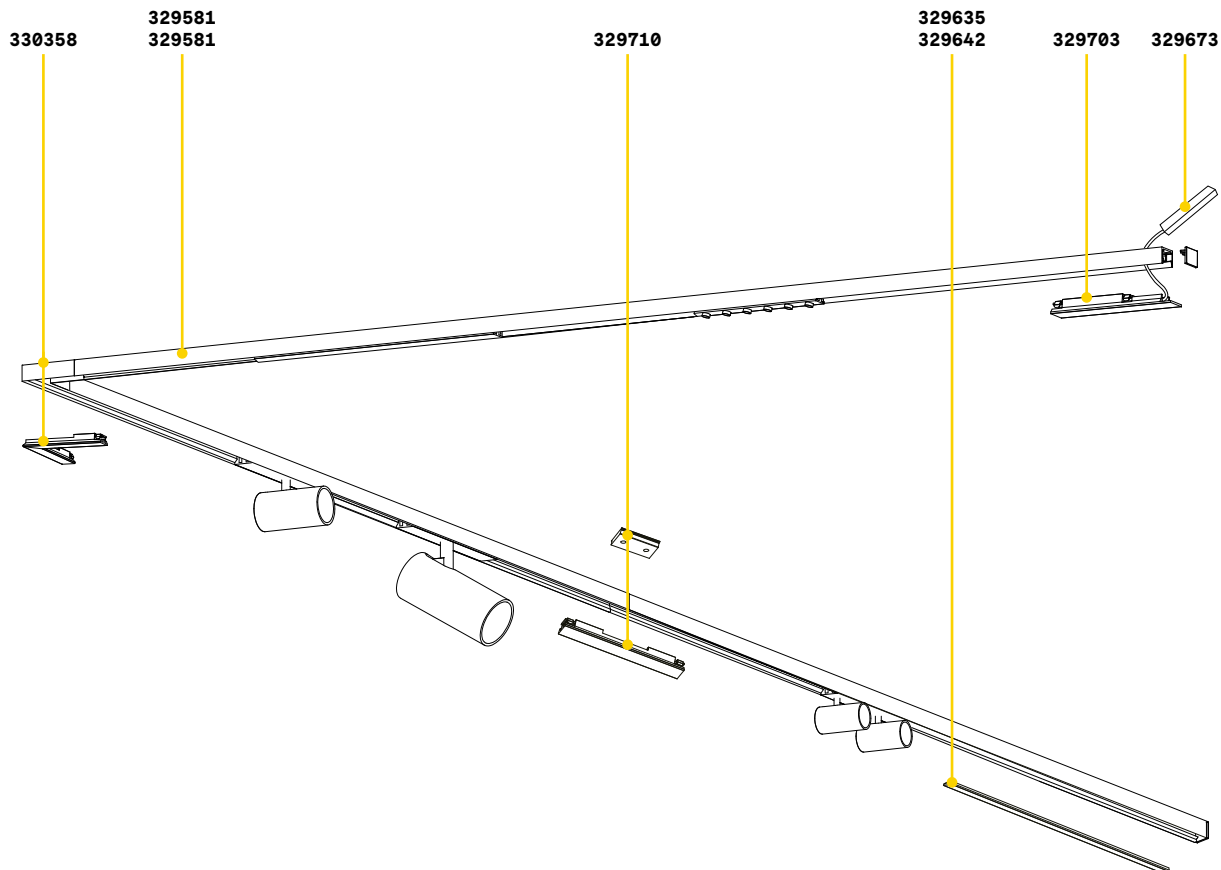

BLINDED COVER



Stick Recessed

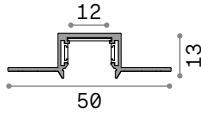

TRACK Kit per montaggio profilo e tappi di chiusura inclusi

Lunghezza	Peso	Volume	Finitura	Codice	€
1000 mm	0,400 Kg	0,0816 m ³	Nero	329598	35 <small>new</small>
2000 mm	0,800 Kg	0,1586 m ³	Nero	329604	65 <small>new</small>

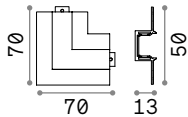

CONNECTOR HORIZONTAL Optional

Peso	Volume	Finitura	Codice	€
0,10 Kg	0,0015 m ³	Nero	330365	47 <small>new</small>



BLINDED COVER

Necessario	Misura (LxHxP)	Finitura	Codice	€
No	1000x3x16 mm	Nero	329635	5 <small>new</small>
	2000x3x16 mm	Nero	329642	8 <small>new</small>

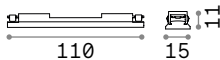

LINEAR CONNECTOR Necessario - 1 Kit x giunzione lineare

Peso	Volume	Finitura	Codice	€
0,03 Kg	0,0001 m ³	Nero	329710	18 <small>new</small>

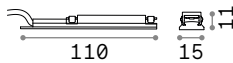

MAIN CONNECTOR Necessario - 1 Kit x punto di alimentazione

Peso	Volume	Finitura	Codice	€
0,08 Kg	0,0003 m ³	Nero	329703	24 <small>new</small>

DRIVER 1-10V Necessario



Potenza	Output	Classe	Misura (LxHxP)	Codice	€
150 W	48 Vdc	<input type="checkbox"/>	350x18x30 mm	329673	115 <small>new</small>

POWER SUPPLY LINEAR Necessario
Sostituisce Driver + Main Connector



Potenza	Output	Classe	Misura (LxHxP)	Codice	€
120 W	48 Vdc	<input type="checkbox"/>	304x32x16 mm	329666	100 <small>new</small>

Stick - Assembly plans

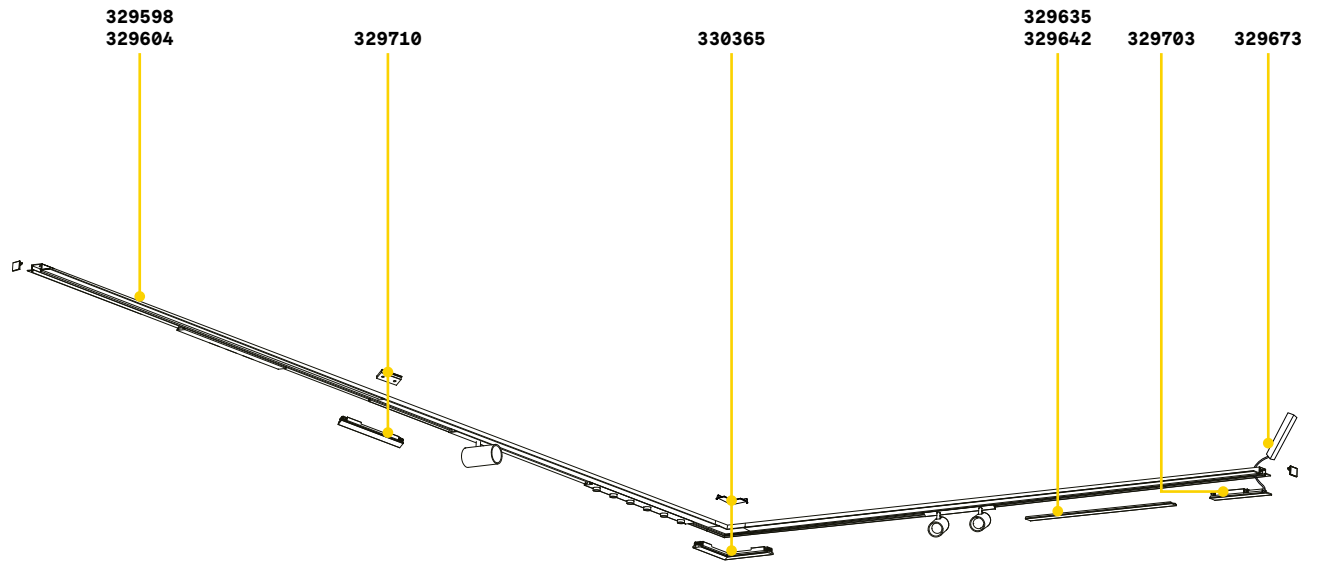

BLINDED COVER



Linus



Lampada lineare in alluminio con illuminazione diretta e indiretta. La lampada è modulare e può essere proposta singolarmente oppure in linea continua. LED integrati; binning iniziale ≤ 3-Step MacAdam; CRI ≥ 80; protezione IP20, classe isolamento I. Alimentatore dimmerabile 1-10V integrato di serie.

Sorgente	LED SMD	Durata LED	50.000 h
Potenza	32W	Classe	I
Driver incluso	1-10V	isolamento	
Driver disponibili	No	IP	20
MacAdam	SDCM 3	Materiale	Alluminio
CCT	3000 K/ 4000 K	Garanzia	5 anni
CRI	≥80		

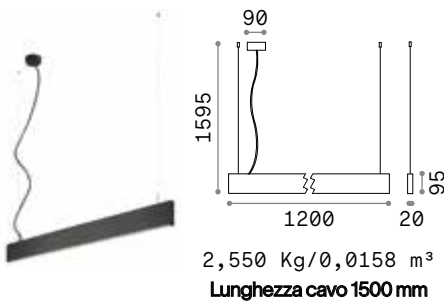

LED SMD Up-light inclusa - Driver 1-10V incluso

Potenza	Angolo	Lumen	CCT	Finitura	Codice	€
32 W	104°	3450 lm	3000 K	Bianco	241968	220
				Nero	241975	220
		3600 lm	4000 K	Bianco	268231	220
				Nero	268217	220

UP-LIGHT INFO

Potenza	Angolo	Lumen	CCT
32 W	104°	3450 lm	3000 K
		3600 lm	4000 K

CORNER Optional - Up-light non inclusa

Potenza	Angolo	Lumen	CCT	Finitura	Codice	€
4 W	104°	430 lm	3000 K	Bianco	241999	46
				Nero	242002	46
		450 lm	4000 K	Bianco	268149	46
				Nero	268118	46

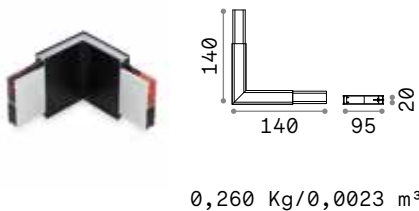

STRUCTURE CONNECTOR

Necessario	Codice	€
SI - 1Kit x giunzione	241982	6



Light beam: **BI-EMISSION**
WIDE

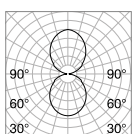

m	lx	Øm
1	572	2,56
2	143	5,12
3	64	7,68
4	36	10,24
5	23	12,80



CRI≥83 32+32W 104°+104° 3600+3600lm 4000K



P. 387



241968

241975

Fluo

Sistema lineare di lampade con scocca in alluminio estruso di sezione larga 50 mm e alta 80 mm. Moduli disponibili in due lunghezze: 1200 mm e 1800 mm, componibili tra loro a seconda della disposizione desiderata. Il sistema è disponibile con tre diverse configurazioni: il modello WIDE diffondente, il modello BI-EMISSION con componente luminosa per l'illuminazione indiretta e il modello ACCENT con controllo dell'abbagliamento (UGR < 13); LED integrati, possibilità di temperatura di colore di 3000 K o di 4000 K; binning iniziale ≤ 3 -Step MacAdam; protezione IP 20, classe isolamento I; durata utile LED 50.000 h L70B50. Il sistema è disponibile nei colori bianco, nero e nelle possibili modalità d'installazione singola o in linea continua, per applicazione a plafone, a sospensione oppure a incasso a filo in soffitti di cartongesso. Driver incluso, integrato nel corpo illuminante, disponibile in versione dimmerabile 1-10V, DALI e Push. Sistema adatto per ambienti dove è richiesta un'illuminazione professionale dal design minimale, ad esempio UFFICI e spazi COMMERCIALI.

PRO

Prodotto ad alto contenuto tecnologico, elevata qualità dei materiali, destinato ad uso professionale.

UGR

Articolo con UGR <13 (Accent).

Sorgente	LED SMD
Driver incluso	On/Off
Driver disponibili	1-10V / DALI
MacAdam	SDCM 3
Ottica	Accent/Wide/Bi-Emission
CCT	3000 K / 4000 K
CRI	≥ 80
UGR	<13 (Accent)
Durata LED	50.000 h
Classe isolamento	I
IP	20
Materiale	Alluminio
Garanzia	5 anni



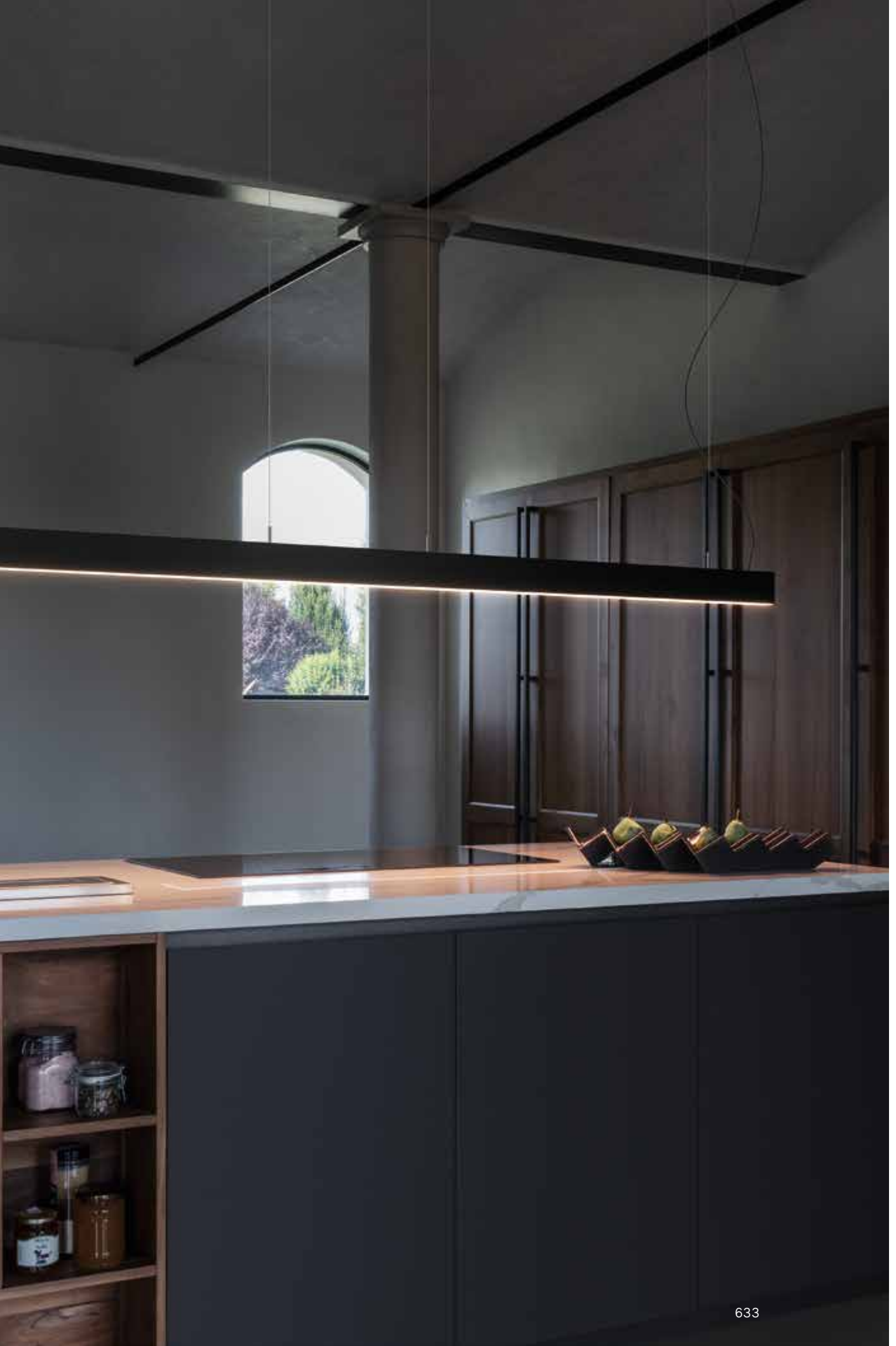

Fluo Accent

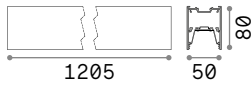
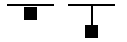

2,760 Kg/0,0183 m³
Lunghezza cavo 2150 mm

LED SMD OSRAM Driver TRIDONIC ON/OFF incluso - UGR <13

Potenza	Angolo	Lumen	CCT	Finitura	Codice	€
30 W	30°	2750 lm	3000 K	Bianco	192611	360
				Nero	192581	360
30 W	30°	2900 lm	4000 K	Bianco	192543	360
				Nero	192529	360

DIMMABLE DRIVER* Optional

	Potenza	Output	Misura (L x H x P)	Codice	€
1-10V	39 W	700 mA	280x21x30 mm	216416	145
DALI/Push	38 W	700 mA	280x21x30 mm	216270	160

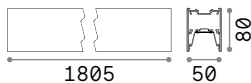

3,860 Kg/0,0269 m³
Lunghezza cavo 2150 mm

LED SMD OSRAM Driver TRIDONIC ON/OFF incluso - UGR <13

Potenza	Angolo	Lumen	CCT	Finitura	Codice	€
30 W	30°	2750 lm	3000 K	Bianco	192499	430
				Nero	192475	430
30 W	30°	2900 lm	4000 K	Bianco	192444	430
				Nero	192420	430

DIMMABLE DRIVER* Optional

	Potenza	Output	Misura (L x H x P)	Codice	€
1-10V	39 W	700 mA	280x21x30 mm	216416	145
DALI/Push	38 W	700 mA	280x21x30 mm	216270	160

MOUNTING KIT Necessario - Pagina 641



Light beam: ACCENT

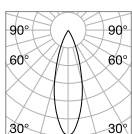

m	lx	Øm
1	8264	0,48
2	2066	0,96
3	918	1,45
4	516	1,93
5	330	2,42



CRI≥83 30W 30° 2900lm 4000K

* Gli alimentatori dimmerabili devono essere ordinati contestualmente al prodotto e verranno già inclusi all'interno degli apparecchi in sostituzione degli alimentatori on-off. La connessione in linea è disponibile soltanto per le versioni on-off dei prodotti.



Fiuo Accent 1200

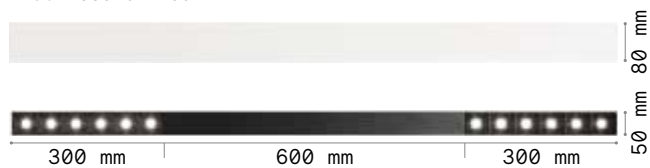

Fiuo Accent 1800

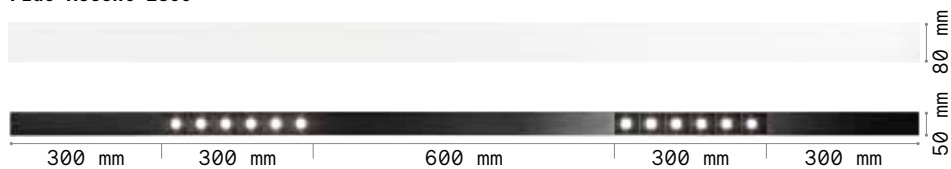

Lo spessore del singolo cappuccio finale è di 2,5 mm.

Fluo Wide

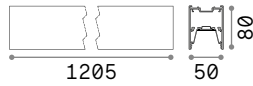

2,890 Kg/0,0183 m³
Lunghezza cavo 2150 mm

LED SMD SAMSUNG Driver TRIDONIC ON/OFF incluso

Potenza	Angolo	Lumen	CCT	Finitura	Codice	€
27 W	105°	3750 lm	3000 K	Bianco	192437	330
				Nero	191997	330
		4050 lm	4000 K	Bianco	192482	330
				Nero	192505	330

DIMMABLE DRIVER* Optional

	Potenza	Output	Misura (L x H x P)	Codice	€
1-10V	28 W	500 mA	280 x 21 x 30 mm	216423	145
DALI/Push	27 W	500 mA	280 x 21 x 30 mm	216287	160



4,420 Kg/0,0257 m³
Lunghezza cavo 2150 mm

LED SMD SAMSUNG Driver TRIDONIC ON/OFF incluso

Potenza	Angolo	Lumen	CCT	Finitura	Codice	€
36 W	105°	5050 lm	3000 K	Bianco	192550	425
				Nero	192567	425
		5300 lm	4000 K	Bianco	192604	425
				Nero	192628	425

DIMMABLE DRIVER* Optional

	Potenza	Output	Misura (L x H x P)	Codice	€
1-10V	39 W	700 mA	280 x 21 x 30 mm	216416	145
DALI/Push	38 W	700 mA	280 x 21 x 30 mm	216270	160

MOUNTING KIT Necessario - Pagina 641



Light beam: **WIDE**

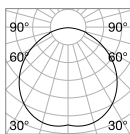

m	lx	Øm
1	1042	2,50
2	260	5,00
3	115	7,50
4	65	10,00
5	41	12,50



CRI≥83 27W 105° 4050lm 4000K

* Gli alimentatori dimmerabili devono essere ordinati contestualmente al prodotto e verranno già inclusi all'interno degli apparecchi in sostituzione degli alimentatori on-off. La connessione in linea è disponibile soltanto per le versioni on-off dei prodotti.



Fluo Wide 1200

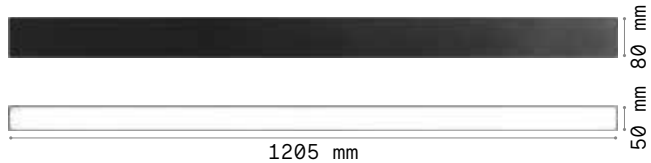

Fluo Wide 1800



Lo spessore del singolo cappuccio finale è di 2,5 mm.

Fluo Bi-Emission*

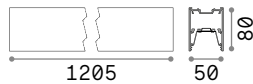

2,890 Kg/0,0183 m³
Lunghezza cavo 2150 mm

LED SMD SAMSUNG

Up-light inclusa - Driver TRIDONIC ON/OFF incluso

Potenza	Angolo	Lumen	CCT	Finitura	Codice	€
27 W	105°	3250 lm	3000 K	Bianco	192666	425
				Nero	192710	425
4050 lm	4000 K	4050 lm	4000 K	Bianco	192741	425
				Nero	192758	425

UP-LIGHT INFO

Potenza	Angolo	Lumen	CCT
13 W	105°	1750 lm	3000 K
		2050 lm	4000 K

KIT DIMMABLE DRIVER*

	Codice	€
1-10V	270692	230
DALI/Push	270876	260



4,420 Kg/0,0269 m³
Lunghezza cavo 2150 mm

LED SMD SAMSUNG

Up-light inclusa - Driver TRIDONIC ON/OFF incluso

Potenza	Angolo	Lumen	CCT	Finitura	Codice	€
36 W	105°	5050 lm	3000 K	Bianco	192703	580
				Nero	192697	580
5350 lm	4000 K	5350 lm	4000 K	Bianco	192673	580
				Nero	192642	580

UP-LIGHT INFO

Potenza	Angolo	Lumen	CCT
18 W	105°	2550 lm	3000 K
		2800 lm	4000 K

KIT DIMMABLE DRIVER*

	Codice	€
1-10V	270883	230
DALI/Push	270937	260



Light beam: **BI-EMISSION**
WIDE

MOUNTING KIT Necessario - Pagina 641

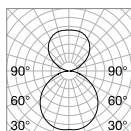

m	lx	Øm
1	512	2,10
2	128	4,21
3	56	6,32
4	32	8,43
5	20	10,54



* Accensione separata dell'emissione diretta e indiretta (disponibile solo per versioni on-off). Regolazione in sincronia dell'emissione diretta e indiretta (versioni con dimmerazione 1-10V e Push). Gli alimentatori dimmerabili devono essere ordinati contestualmente al prodotto e verranno già inclusi all'interno degli apparecchi in sostituzione degli alimentatori on-off. La connessione in linea è disponibile soltanto per le versioni on-off dei prodotti.

CRI≥83 27+13W 105°+105° 4050+2050lm 3000K

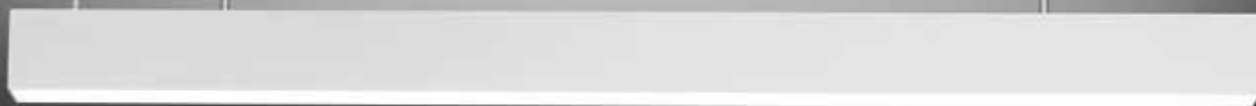

Fluo Bi-Emission 1200



Fluo Bi-Emission 1800

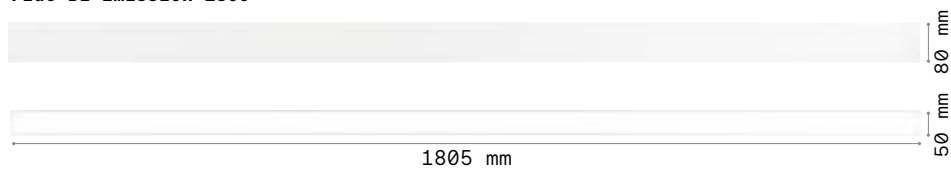

Lo spessore del singolo cappuccio finale è di 2,5 mm.

Fluo - Assembly plans

FLUO SUSPENSION

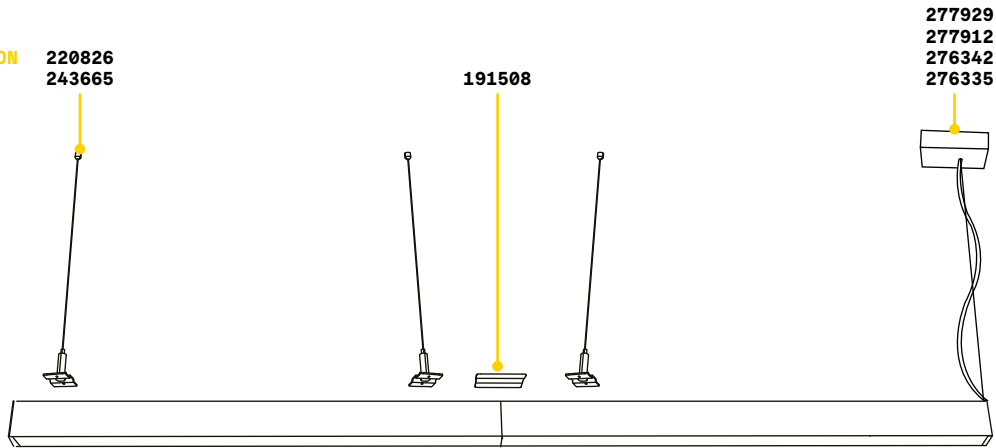



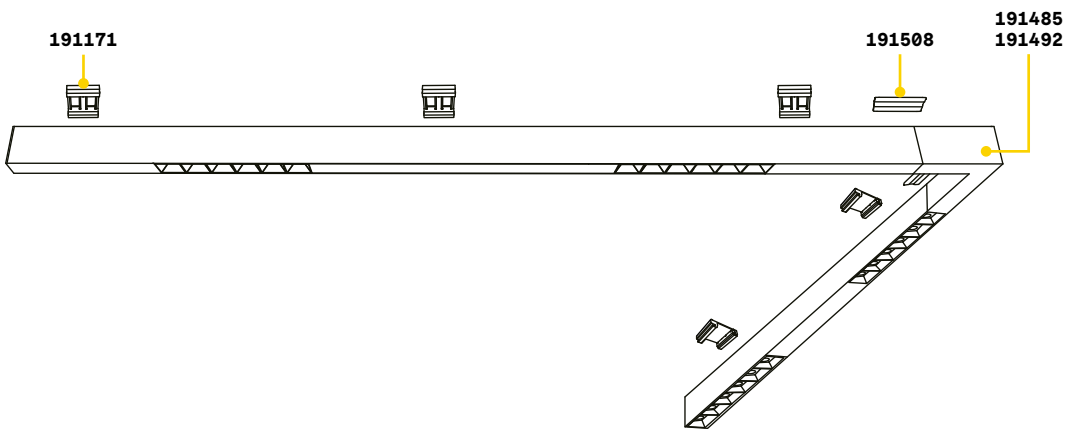

FLUO SURFACE

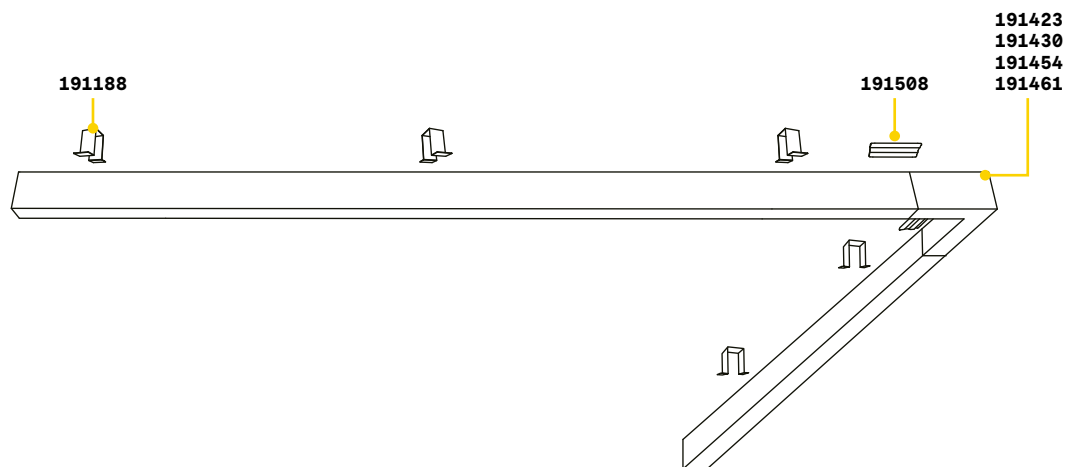

FLUO RECESSED



Fluo - Mounting kit

	Necessario	N° Cavi	Lunghezza cavi	Finitura	Codice	€
 KIT SUSPENSION	SI - 1 kit x punto di alimentazione	1	2000 mm	Bianco	277929	32
				Nero	277912	32
		1	5000 mm	Bianco	276342	43
				Nero	276335	43
 KIT SINGLE CABLE	SI - 1 Kit x 600 mm	1	2000 mm		220826	13
		1	5000 mm		243665	20
 KIT RECESSED	SI - 1 Kit x 600 mm				191188	25
 KIT SURFACE	SI - 1 Kit x 600 mm				191171	25

Fluo - Optional

CORNER Optional - Driver ON/OFF incluso - Compatibile con versione Wide

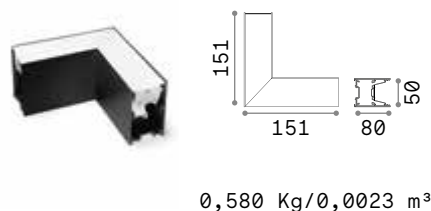

Potenza	Angolo	Lumen	CCT	Finitura	Codice	€
8 W	105°	950 lm	3000 K	Bianco	191423	120
				Nero	191430	120
		1000 lm	4000 K	Bianco	191454	120
				Nero	191461	120

BLINDED CORNER Optional - Compatibile con versione Accent

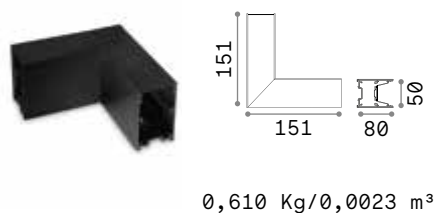

Finitura	Codice	€
Bianco	191485	65
Nero	191492	65

STRUCTURE CONNECTOR Lunghezza max per punto di alimentazione: 30 metri



Necessario	Codice	€
SI - 1 Kit x giunzione	191508	12

Steel

Lampada lineare in alluminio con illuminazione diretta e indiretta con controllo dell'abbagliamento. La componente di luce indiretta può essere accesa o spenta mediante interruttore a bordo dell'apparecchio. La lampada è disponibile nel modello WIDE con ottica downlight diffondente in PMMA microprismatizzato (UGR < 19) e nel modello ACCENT con riflettore nero (UGR < 16). Sorgenti LED integrati; disponibile in CCT 3000 K e 4000 K; CRI ≥ 90; lifetime 50.000 h L70B50; IP20. Adatta per uffici, spazi commerciali e retail.

PRO Prodotto ad alto contenuto tecnologico, elevata qualità dei materiali, destinato ad uso professionale.

UGR Articolo con UGR <16 (Accent), <19 (Wide).

Sorgente	LED SMD
Driver incluso	On/Off
Driver disponibili	No
MacAdam	SDCM 3
Ottica	Accent/Wide
CCT	3000 K / 4000 K
CRI	≥90
UGR	<16 (Accent) / <19 (Wide)
Durata LED	50.000 h
Classe isolamento	I
IP	20
Materiale	Alluminio
Garanzia	5 anni





Steel

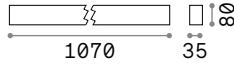
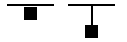

1,990 Kg/0,0178 m³
Lunghezza cavo 1800 mm

LED SMD SAMSUNG

Up-light inclusa - Driver OSRAM ON/OFF incluso - UGR <19

Potenza	Angolo	Lumen	CCT	Finitura	Codice	€
36 W	70°	3350 lm	3000 K	Bianco	267128	290
				Nero	270197	290
		3550 lm	4000 K	Bianco	270203	290
				Nero	267135	290

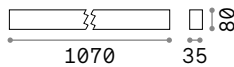

1,980 Kg/0,0178 m³
Lunghezza cavo 1800 mm

LED SMD SAMSUNG

Up-light inclusa - Driver OSRAM ON/OFF incluso - UGR <16

Potenza	Angolo	Lumen	CCT	Finitura	Codice	€
36 W	60°	3000 lm	3000 K	Bianco	270180	345
				Nero	267142	345
		3200 lm	4000 K	Bianco	267159	345
				Nero	270173	345

UP-LIGHT INFO

Angolo	Lumen	CCT
110°	1100 lm	3000 K
	1150 lm	4000 K



KIT SUSPENSION

Necessario	N° Cavi	Lunghezza cavi	Finitura	Codice	€
SI - 1 kit x punto di alimentazione	1	2000 mm	Bianco	276311	35
			Nero	276304	35



KIT SINGLE CABLE

SI - 1 Kit x 500 mm	1	2000 mm		271750	13
---------------------	---	---------	--	--------	----



KIT SURFACE

SI - 1 Kit x 1000 mm				270210	31
----------------------	--	--	--	--------	----



KIT CONTINUOS

SI - 1 Kit x giunzione				271712	7
------------------------	--	--	--	--------	---



Light beam: **BI-EMISSION WIDE**

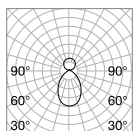

m	lx	Øm
1	1173	1,50
2	293	3,10
3	130	4,60
4	73	6,20
5	47	7,70



CRI≥90 36W 70° 3550lm 4000K



Light beam: **BI-EMISSION ACCENT**

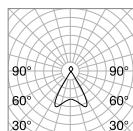

m	lx	Øm
1	2216	1,20
2	554	2,40
3	246	3,60
4	139	4,80
5	89	6,10



CRI≥90 36W 60° 3200lm 4000K



Steel Accent



1070

Steel Wide



1070

Office



Lampada lineare in alluminio con illuminazione diretta per applicazione a sospensione. Disponibile in finitura bianca o nera con riflettori di colore nero. Sorgenti LED integrate con controllo dell'abbagliamento (UGR < 16); disponibile in temperatura di colore 3000 K e 4000 K; CRI ≥ 80; 30.000 h di durata L70B50; protezione IP20, classe isolamento I.

Sorgente	LED SMD	Durata LED	50.000 h
Potenza	30W	Classe	I
Driver incluso	On/Off	isolamento	
Driver disponibili	No	IP	20
CCT	3000 K / 4000 K	Materiale	Alluminio
CRI	≥80	Garanzia	5 anni
UGR	<16		

UGR Articolo con UGR <16.

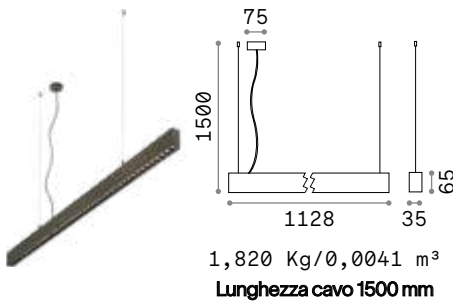

LED SMD Driver ON/OFF incluso

Potenza	Angolo	Lumen	CCT	Finitura	Codice	€
30 W	37°	2800 lm	3000 K	Bianco	271194	188
				Nero	271187	188
30 W	37°	3100 lm	4000 K	Bianco	271217	188
				Nero	271200	188



Light beam: ACCENT

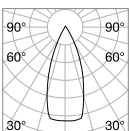

m	lx	Øm
1	6008	0,72
2	1502	1,40
3	668	2,20
4	376	2,90
5	240	3,60



CRI≥80 30W 37° 3100lm 4000K



271194

271187

Profilo componibile in alluminio estruso verniciato, diffusore in policarbonato opalino, tecnologia LED SMD. Moduli disponibili in due lunghezze lineari 260 mm e 500 mm e in versione ad angolo verticale, componibili tra loro mediante innesti rapidi a seconda della disposizione desiderata fino a una lunghezza continua massima di 3 metri. Disponibile in versione on-off, oppure con sistema di controllo dimmerabile mediante pulsante o sensore di prossimità. Disponibile in temperatura di colore 3000 K; CRI ≥ 80; classe isolamento III, alimentazione in 24 Vdc; durata utile LED 30.000 h L70B50. Adatto per installazione in sottopensili, cucine e armadi.

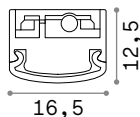

LED SMD

Lunghezza	Potenza	Lumen	CCT	Finitura	Codice	€
257 mm	3,5 W	300 lm	3000 K	Bianco	297163	15 <small>new</small>
500 mm	7 W	600 lm	3000 K	Bianco	297170	25 <small>new</small>

0,060 Kg/0,0001 m³

0,130 Kg/0,0002 m³

Lunghezza cavo 1000 mm

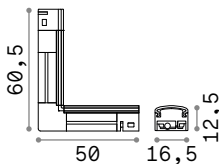

VERTICAL CORNER Optional

Potenza	Lumen	CCT	Finitura	Codice	€
1 W	80 lm	3000 K	Bianco	297187	15 <small>new</small>

0,004 Kg/0,0001 m³



INSTALLATION CLIPS



INSTALLATION CLIPS 45°



Chef

INPUT POWER SOURCE



INPUT CABLE

INPUT BUTTON SWITCH

INPUT SENSOR SWITCH

Necessario	Controllo	Lung. cavo	Codice	€
1 Kit x punto di alimentazione	On-Off	1000 mm	297194	5 <small>new</small>
1 Kit x punto di alimentazione	Dimmer touch	1000 mm	297217	15 <small>new</small>
1 Kit x punto di alimentazione	Dimmer sensor	1000 mm	297200	20 <small>new</small>



INTERCONNECTION CABLE

Necessario	Lung. cavo	Codice	€
SI - 1 Kit x giunzione	1000 mm	297224	7 <small>new</small>

DRIVER ON/OFF Necessario - Lunghezza cavo 1500 mm



Potenza	Output	Classe	Misura (L x H x P)	Codice	€
12 W	24 Vdc	□	80x23x38 mm	297255	20 <small>new</small>
25 W	24 Vdc	□	135x29x45 mm	297262	30 <small>new</small>
40 W	24 Vdc	□	150x29x45 mm	297279	40 <small>new</small>



INSTALLATION CLIPS

INSTALLATION CLIPS 45°

Necessario	Codice	€
SI - 1 Kit x profilo	297231	2 <small>new</small>
SI - 1 Kit x profilo	297248	2 <small>new</small>





Interni

LED Strip e supporti

Indice alfabetico

Slot	664
Strip	654
Tesi	656
Vision	658

Indice icone



Strip [654](#)



Tesi [656](#)



Vision Trimless [660](#)



Vision Trim [662](#)



Slot Recessed [666](#)



Slot Surface [668](#)



Slot Angular [670](#)

Strip LED and Drivers

Volt 24 Vdc
 MacAdam SDCM 3
 CRI ≥ 90
 Angolo 120°
 Durata LED 35.000 h

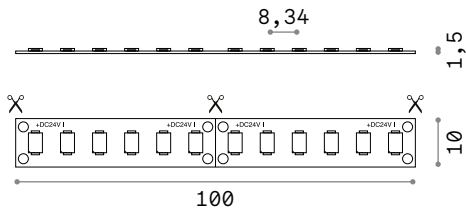

SMD 2835 120 LED/m

Potenza	IP	Lumen	CCT	Lunghezza	Codice	€
15 W/m	IP20	1400 lm/m	2700 K	5000 mm	272498	50
		1450 lm/m	3000 K	5000 mm	272481	50
		1600 lm/m	4000 K	5000 mm	272474	50
	IP65	1400 lm/m	3000 K	5000 mm	272504	65
		1480 lm/m	4000 K	5000 mm	287959	65

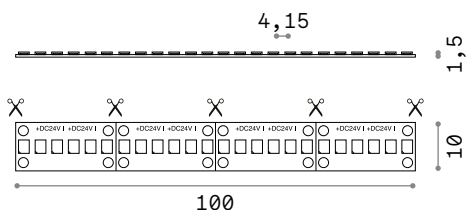

SMD 2835 240 LED/m

Potenza	IP	Lumen	CCT	Lunghezza	Codice	€
20,5 W/m	IP20	2000 lm/m	2700 K	5000 mm	272535	80
		2050 lm/m	3000 K	5000 mm	272528	80
		2100 lm/m	4000 K	5000 mm	272511	80
	IP65	2000 lm/m	3000 K	5000 mm	272542	90
			2020 lm/m	4000 K	5000 mm	287966

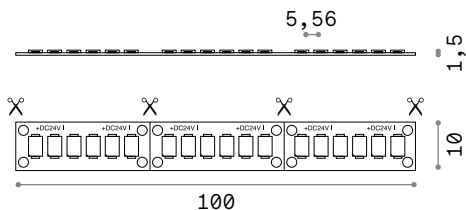

SMD 2835 180 LED/m

Potenza	IP	Lumen	CCT	Lunghezza	Codice	€
40 W/m	IP20	3370 lm/m	3000 K	3000 mm	253886	120
		3730 lm/m	4000 K	3000 mm	253893	120

Necessario	Codice	€
No	292939	2
No	292953	2



MAIN CONNECTOR



LINEAR CONNECTOR



DRIVER Solo per installazione in interni



	Potenza	Output	Classe	Misura (LxHxP)	Codice	€
On-Off	30 W	24 Vdc	□	140 x 28 x 45 mm	124070	17,50
	60 W	24 Vdc	□	186 x 33 x 50 mm	124087	30
	150 W	24 Vdc	⊕	268 x 31 x 45 mm	124117	50
1-10V/Push	36 W	24 Vdc	□	293 x 30 x 43 mm	244556	60
	100 W	24 Vdc	⊕	210 x 34 x 67 mm	244570	100
	150 W	24 Vdc	⊕	352 x 30 x 43 mm	244594	140
DALI/Push	36 W	24 Vdc	□	175 x 30 x 44 mm	244549	75
	80 W	24 Vdc	⊕	295 x 35 x 45 mm	244563	115
	150 W	24 Vdc	⊕	273 x 37 x 57 mm	244587	150

Tesi

Nastro flessibile in acciaio per applicazione da parete a parete, utilizzato come supporto per applicazione di strip led, diventa una sorgente luminosa per illuminazione indiretta. Ha una lunghezza massima di 5 o 10 metri e con la sua sezione minimale scompare all'interno dell'ambiente per garantire un risultato di estrema pulizia formale. Disponibile nelle finiture acciaio, bianco oppure nero. Ideale per ambienti dal carattere storico e architettonico già fortemente personalizzati.

STRIP LED SUPPORT

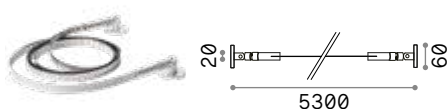

Lunghezza	Peso	Volume	Finitura	Codice	€
5000 mm	0,35 Kg	0,0234 m ³	Acciaio	258300	130
			Bianco	302256	130
			Nero	302263	130

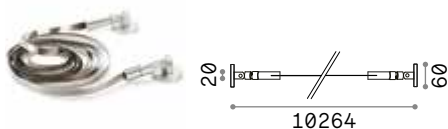

Lunghezza	Peso	Volume	Finitura	Codice	€
10000 mm	0,45 Kg	0,0029 m ³	Acciaio	302270	165
			Bianco	302287	165
			Nero	302294	165

RECOMMENDED STRIP LED AND DRIVER

STRIP LED SMD 2835 120 LED/m CRI≥90

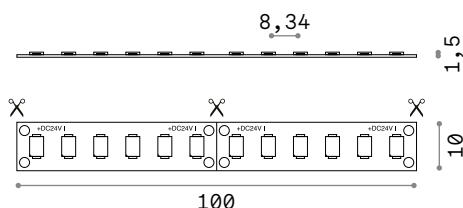

Potenza	IP	Lumen	CCT	Lunghezza	Codice	€
15 W/m	IP20	1400 lm/m	2700 K	5000 mm	272498	50
		1450 lm/m	3000 K	5000 mm	272481	50
		1600 lm/m	4000 K	5000 mm	272474	50
	IP65	1400 lm/m	3000 K	5000 mm	272504	65
		1480 lm/m	4000 K	5000 mm	287959	65

DRIVER ON/OFF



Light beam: INDIRECT



Potenza	Output	Classe	Misura (L x H x P)	Driver box	Codice	€
30 W	24 Vdc	□	140 x 28 x 45 mm	255 x 55 x 75 mm	124070	17,50
60 W	24 Vdc	□	186 x 33 x 50 mm	255 x 55 x 75 mm	124087	30
150 W	24 Vdc	⊕	268 x 31 x 45 mm	330 x 60 x 80 mm	124117	50



Vision

Profilo in alluminio estruso con superficie anodizzata e verniciata a polveri, disponibile nelle finiture bianco e nero, diffusore in PMMA satinato. Sono disponibili barre in diverse lunghezze nella versione TRIM per installazione a incasso in pannelli o soffitti in cartongesso e nella versione TRIMLESS per installazione a parete e soffitto, disponibile kit per installazione a sospensione. I profili lineari sono disponibili nelle lunghezze di 2000 e 3000 mm, sono componibili a seconda del disegno desiderato e sono sezionabili a misura. Strip LED e driver devono essere abbinati per completare l'installazione: sorgenti luminose di potenza disponibili con temperatura di colore di 3000 K e 4000 K, CRI ≥ 90 e indice protezione IP20. Sistema dotato di ampia flessibilità, adatto per l'illuminazione generale degli ambienti COMMERCIALI e nelle aree vendita nel settore RETAIL.

Versione	Trim / Trimless
Lunghezza	2000 / 3000 mm
Materiale	Alluminio





Vision Trimless

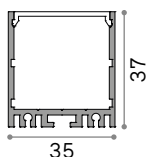

PROFILE Kit per montaggio incluso

Lunghezza	Peso	Volume	Finitura	Codice	€
2000 mm	1,40 Kg	0,0032 m ³	Bianco	270524	65
	1,40 Kg	0,0032 m ³	Nero	270517	65
3000 mm	2,10 Kg	0,0048 m ³	Bianco	270548	95
	2,10 Kg	0,0048 m ³	Nero	270531	95



SUSPENSION KIT

Necessario	N° Cavi	Lunghezza cavi	Codice	€
No - 1 Kit x 2000 mm	2	3000 mm	270449	16
No - 1 Kit x 2000 mm	2	5000 mm	270456	20



STRUCTURE CONNECTOR

SI - 1 Kit x giunzione			270463	5
------------------------	--	--	--------	---

STRIP LED AND DRIVER Strip LED consigliata max 40 W/m

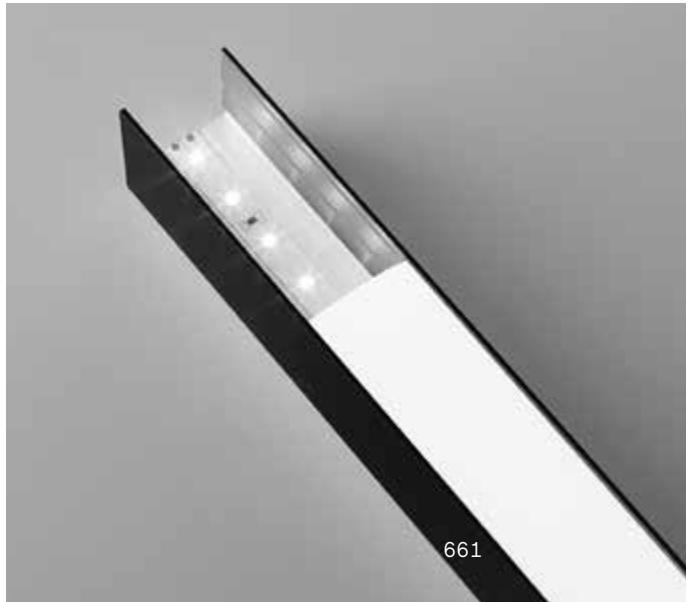

Vision Trim

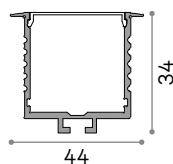
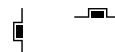

PROFILE Kit per montaggio incluso

Lunghezza	Peso	Volume	Finitura	Codice	€
2000 mm	1,26 Kg	0,0050 m ³	Bianco	270487	70
	1,26 Kg	0,0050 m ³	Nero	270470	70
3000 mm	1,89 Kg	0,0075 m ³	Bianco	270500	105
	1,89 Kg	0,0075 m ³	Nero	270494	105



STRUCTURE CONNECTOR

Necessario	Codice	€
SI - 1 Kit x giunzione	271125	5

STRIP LED AND DRIVER Strip LED consigliata max 40 W/m

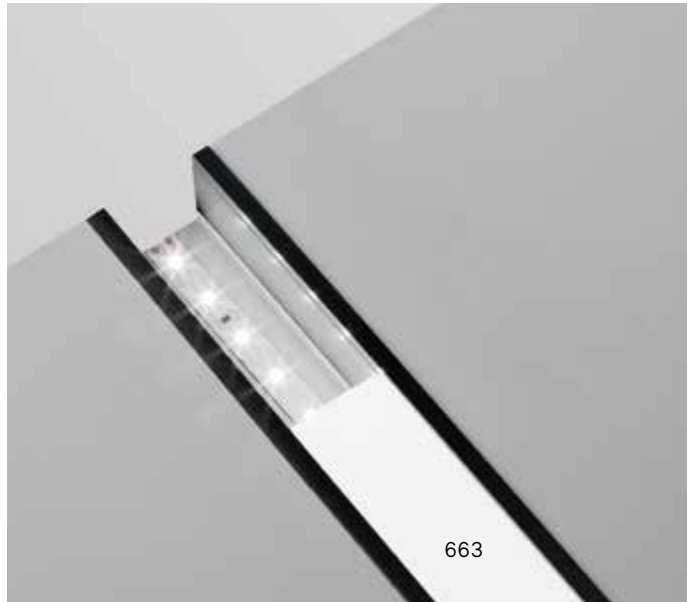

Slot

Profilo in alluminio estruso con superficie anodizzata o verniciata a polveri, disponibile nelle finiture bianco, nero e alluminio, diffusore in PMMA satinato. Sono disponibili barre in diverse sezioni e lunghezze nella versione RECESSED per installazione a incasso in soffitti in cartongesso e nella versione SURFACE per installazione a parete o soffitto. I modelli ANGULAR in versione tonda e quadrata sono concepiti con un angolo interno di inclinazione della sorgente luminosa per l'illuminazione ottimale all'interno di velette e gole luminose. I profili lineari sono disponibili nelle lunghezze di 1000, 2000 e 3000 mm, sono componibili a seconda del disegno desiderato e sono sezionabili a misura. Strip LED e driver devono essere abbinati per completare l'installazione: sorgenti luminose disponibile con temperatura di colore di 2700 K, 3000 K, 4000 K, CRI ≥ 80 , ≥ 85 e ≥ 90 , indice protezione IP20 e IP65.

Versione	Recessed / Surface / Angular
Larghezza	12 / 14 / 15 / 16 / 20 / 31 mm
Materiale	Alluminio



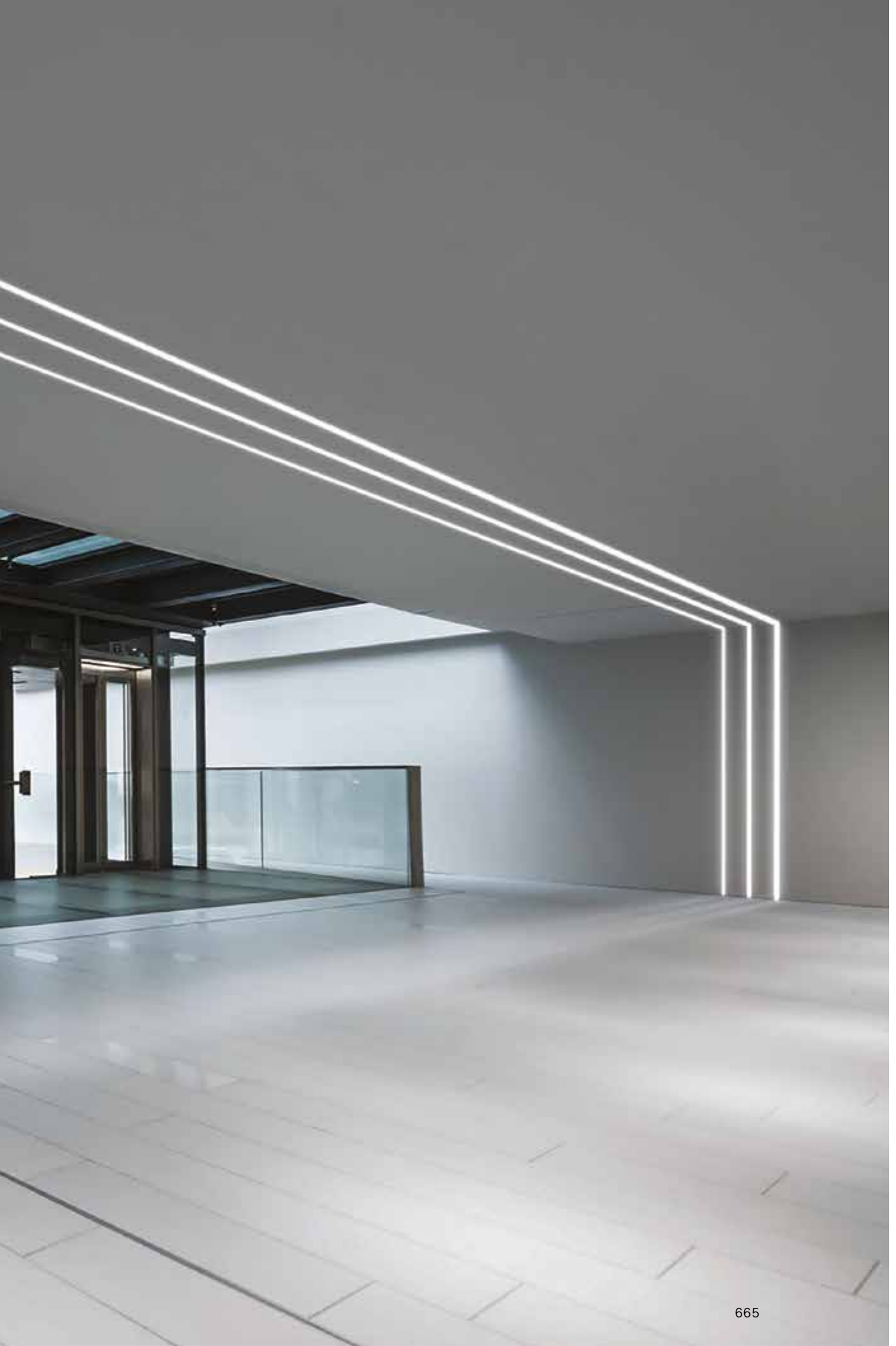

Slot Recessed

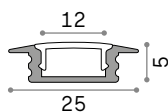
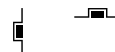

PROFILE 12 mm Kit per montaggio incluso - Non compatibile con strip LED IP65

Lunghezza	Peso	Volume	Finitura	Codice	€
1000 mm	0,15 Kg	0,0010 m ³	Bianco	124155	16
2000 mm	0,35 Kg	0,0020 m ³	Bianco	203102	27
3000 mm	0,54 Kg	0,0029 m ³	Bianco	204611	40

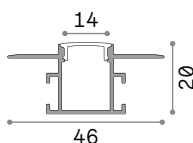

PROFILE 14 mm

Lunghezza	Peso	Volume	Finitura	Codice	€
2000 mm	0,65 Kg	0,0020 m ³	Bianco	223704	62
3000 mm	0,90 Kg	0,0029 m ³	Bianco	223711	98

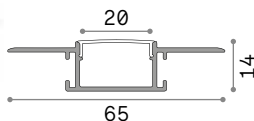

PROFILE 20 mm

Lunghezza	Peso	Volume	Finitura	Codice	€
2000 mm	0,60 Kg	0,0020 m ³	Bianco	223728	73
3000 mm	0,90 Kg	0,0029 m ³	Bianco	223735	107

KIT PROFILE 14 / 20 mm



KIT LINEAR

KIT RIGHT-LEFT

KIT VERTICAL-HORIZONTAL

Necessario	Codice	€
SI - 1 Kit x giunzione	223766	6
SI - 1 Kit x giunzione	223759	6
SI - 1 Kit x giunzione	223742	6

STRIP LED AND DRIVER Strip LED consigliata max 15 W/m

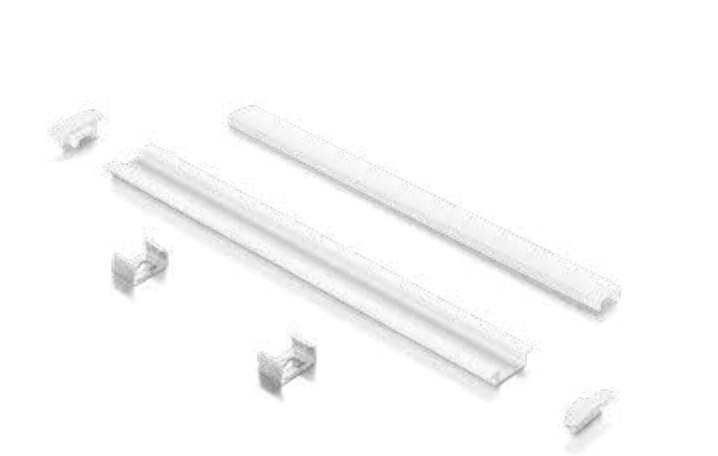
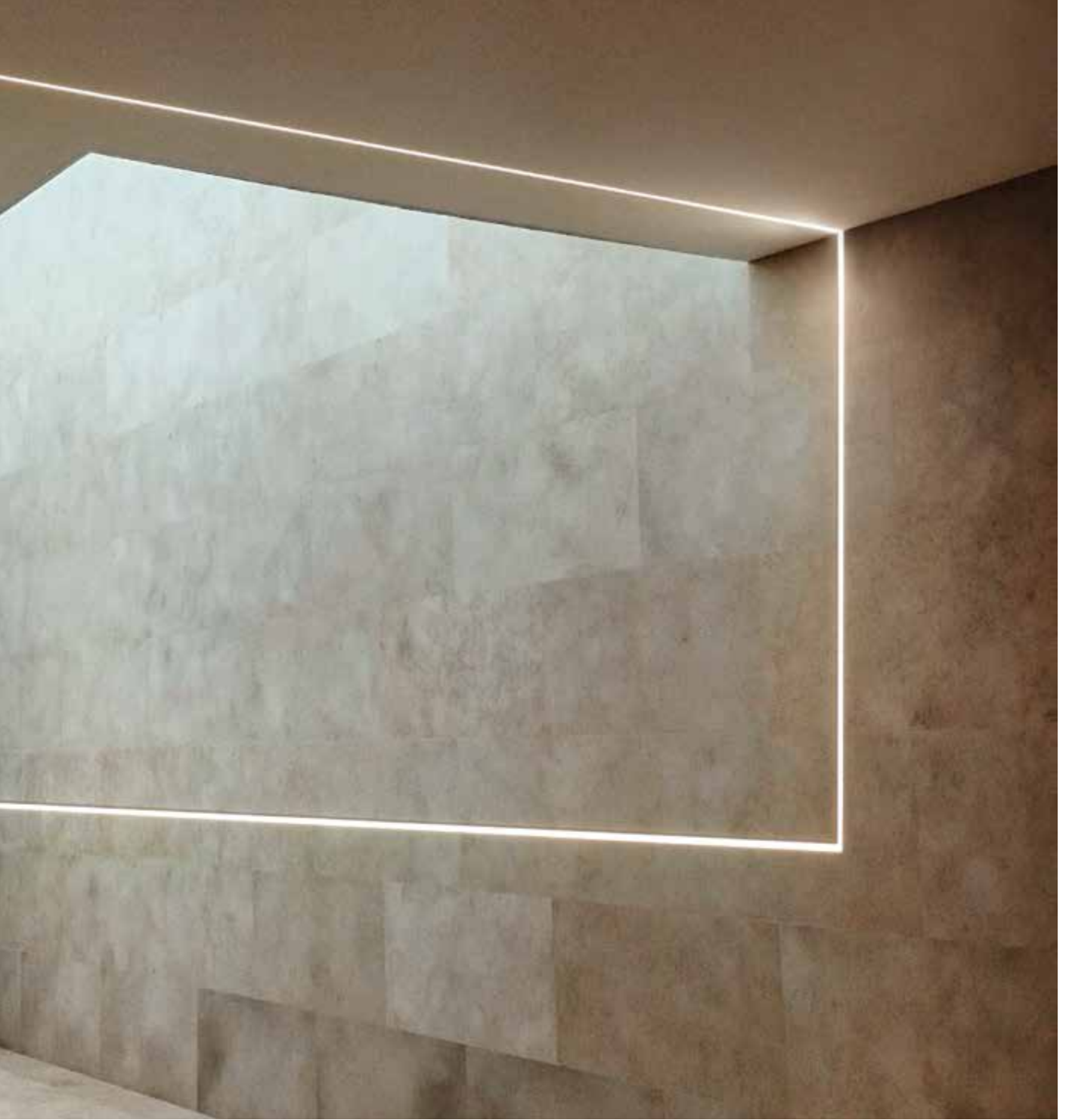

Kit per montaggio PROFILE 12 mm.



223728
223735

Slot Surface

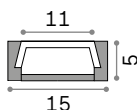
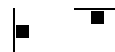

PROFILE 11mm Kit per montaggio incluso

Lunghezza	Peso	Volume	Finitura	Codice	€
1000 mm	0,15 Kg	0,0010 m ³	Bianco	124131	13
	0,15 Kg	0,0010 m ³	Alluminio	124124	13
2000 mm	0,20 Kg	0,0020 m ³	Bianco	203089	22
	0,20 Kg	0,0020 m ³	Alluminio	203072	22
3000 mm	0,34 Kg	0,0029 m ³	Bianco	204598	32
	0,34 Kg	0,0029 m ³	Alluminio	204581	32

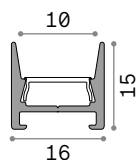

PROFILE 10 mm Kit per montaggio incluso - Non compatibile con strip LED IP65

Lunghezza	Peso	Volume	Finitura	Codice	€
2000 mm	0,20 Kg	0,0015 m ³	Bianco	307145	25
			Nero	296463	25

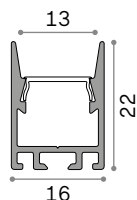

PROFILE 13 mm Kit per montaggio incluso - Non compatibile con strip LED IP65

Lunghezza	Peso	Volume	Finitura	Codice	€
2000 mm	0,40 Kg	0,0021 m ³	Bianco	307152	29
			Nero	296456	29



COVER 16 mm

Necessario	Finitura	Codice	€
No	Nero	307251	6

STRIP LED AND DRIVER Strip LED consigliata max 15 W/m



Kit per montaggio PROFILE 15 mm.



Cover 16 mm.

Slot Angular

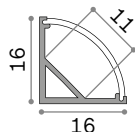
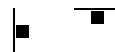

ROUND 16x16

Lunghezza	Peso	Volume	Finitura	Codice	€
1000 mm	0,15 Kg	0,0010 m ³	Bianco	126548	12
	0,15 Kg	0,0010 m ³	Alluminio	126531	12
2000 mm	0,30 Kg	0,0020 m ³	Bianco	203126	28
	0,30 Kg	0,0020 m ³	Alluminio	203119	28
3000 mm	0,44 Kg	0,0029 m ³	Bianco	204635	40
	0,44 Kg	0,0029 m ³	Alluminio	204628	40

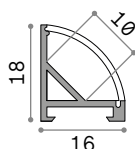

ROUND 18x16

Lunghezza	Peso	Volume	Finitura	Codice	€
2000 mm	0,30 Kg	0,0020 m ³	Bianco	267401	24
	0,30 Kg	0,0020 m ³	Alluminio	267395	24
3000 mm	0,45 Kg	0,0029 m ³	Bianco	267425	38
	0,45 Kg	0,0029 m ³	Alluminio	267418	38

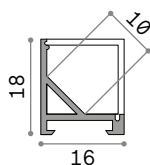

SQUARE 18x16

Lunghezza	Peso	Volume	Finitura	Codice	€
2000 mm	0,30 Kg	0,0020 m ³	Bianco	267449	26
	0,30 Kg	0,0020 m ³	Alluminio	267432	26
3000 mm	0,45 Kg	0,0029 m ³	Bianco	267463	38
	0,45 Kg	0,0029 m ³	Alluminio	267456	38

STRIP LED AND DRIVER Strip LED consigliata max 15 W/m

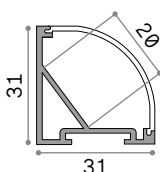

ROUND 31x31

Lunghezza	Peso	Volume	Finitura	Codice	€
2000 mm	0,70 Kg	0,0020 m ³	Bianco	267722	32
	0,70 Kg	0,0020 m ³	Alluminio	267715	32
3000 mm	1,05 Kg	0,0029 m ³	Bianco	267746	44
	1,05 Kg	0,0029 m ³	Alluminio	267739	44

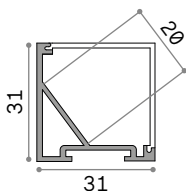

SQUARE 31x31

Lunghezza	Peso	Volume	Finitura	Codice	€
2000 mm	0,70 Kg	0,0020 m ³	Bianco	267487	35
	0,70 Kg	0,0020 m ³	Alluminio	267470	35
3000 mm	1,05 Kg	0,0029 m ³	Bianco	267500	50
	1,05 Kg	0,0029 m ³	Alluminio	267494	50

STRIP LED AND DRIVER Strip LED consigliata max 20 W/m



Kit per montaggio PROFILE 16x16 mm.



















Interni

Proiettori e binari

Indice alfabetico

Byte	706
Byte LED	707
Display	710
Eos	698
Fox	690
Glim	705
Link	718
Look	708
Mouse	704
Pov	702
Quick	674
Smile	685
Spot	704

Indice icone

		 <small>new</small>
Quick 674	Smile 682	Fox 690
		 <small>new</small>
Eos 698	Pov 702	Mouse 704
		
Spot 704	Glim 705	Byte 706
	 <small>new</small>	
Byte LED 707	Look 708	
		
Display Accent 712	Display Wide 714	Display UGR 716
 <small>new</small>		
Link 718		

Quick

Proiettore cilindrico in alluminio estruso adatto per installazione su binario trifase. Verniciatura a polveri bianco o nero, testata girevole 355° e orientabile 90°. Il driver di alimentazione incluso, trova alloggiamento nel corpo cilindrico del proiettore stesso. Sorgente luminosa con tecnologia COB LED integrato per la massima efficienza, disponibile con temperatura di colore di 3000 K o 4000 K; LED efficienza energetica elevata resa cromatica fino a CRI ≥90; binning iniziale ≤3-Step MacAdam; ottica a fascio simmetrico con tre diversi angoli di emissione e controllo dell'abbagliamento (UGR <19). Montaggio e smontaggio senza utensili. Protezione IP20; classe isolamento I; durata utile LED 50.000 h L80B50. Ideale per l'illuminazione di grandi ambienti dove viene richiesta ampia flessibilità e resa cromatica, ad esempio spazi MUSEALI, COMMERCIALI e RETAIL.

PRO

Prodotto ad alto contenuto tecnologico, elevata qualità dei materiali, destinato ad uso professionale.

Sorgente	LED COB
Potenza	15W / 21W / 28W
Driver incluso	On/Off
Driver disponibili	No
Binario	Trifase (standard Eutrac)
MacAdam	SDCM 3
CCT	3000 K / 4000 K
CRI	≥80 / ≥90
Durata LED	50.000h
Classe isolamento	I
IP	20
Materiale	Alluminio
Garanzia	5 anni



[Link - Pagina 718](#)





Quick 15W

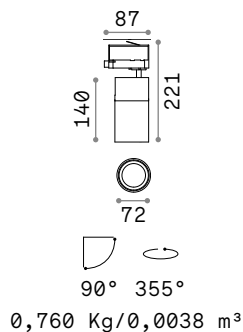

LED COB CITIZEN

CRI ≥ 80

Potenza	Angolo	Lumen	CCT	Finitura	Codice	€
15 W	30°	1800 lm	3000 K	Bianco	222509	145
				Nero	222523	145
		1950 lm	4000 K	Bianco	222530	145
				Nero	222547	145

CRI ≥ 90

Potenza	Angolo	Lumen	CCT	Finitura	Codice	€
15 W	30°	1550 lm	3000 K	Bianco	222554	145
				Nero	222561	145
		1700 lm	4000 K	Bianco	222578	145
				Nero	222585	145



FILTER HONEYCOMB



LENS*



SINGLE CONNECTION

Necessario	Angolo	Finitura	Codice	€
No		Nero	222608	9
No	15°	Trasparen.	222592	9
No	45°	Trasparen.	253558	9
No		Bianco	170145	27
No		Nero	170152	27



Light beam: ACCENT

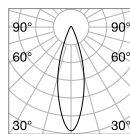

m	lx	Øm
1	3451	0,51
2	862	1,02
3	383	1,53
4	215	2,04
5	138	2,55



CRI ≥ 80 15W 30° 1800lm 3000K

* La lente deve essere ordinata contestualmente al prodotto e verrà montata nel prodotto al posto della lente standard inclusa.



Quick 21W

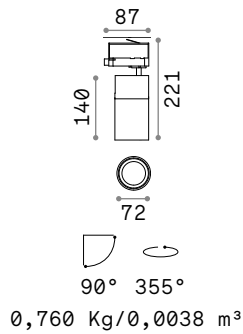

LED COB CITIZEN

CRI ≥ 80

Potenza	Angolo	Lumen	CCT	Finitura	Codice	€
21W	30°	2450 lm	3000 K	Bianco	247946	155
				Nero	247939	155
	2700 lm	4000 K	Bianco	247960	155	
			Nero	247953	155	

CRI ≥ 90

Potenza	Angolo	Lumen	CCT	Finitura	Codice	€
21W	30°	2150 lm	3000 K	Bianco	247977	155
				Nero	225364	155
	2350 lm	4000 K	Bianco	247991	155	
			Nero	247984	155	



FILTER HONEYCOMB



LENS*



SINGLE CONNECTION

Necessario	Angolo	Finitura	Codice	€
No		Nero	222608	9
No	15°	Trasparen.	222592	9
No	45°	Trasparen.	253558	9
No		Bianco	170145	27
		Nero	170152	27



Light beam: ACCENT

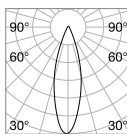

m	lx	Øm
1	6576	0,57
2	1644	1,14
3	731	1,71
4	411	2,28
5	263	2,85



CRI ≥ 80 21W 30° 2450lm 3000K

* La lente deve essere ordinata contestualmente al prodotto e verrà montata nel prodotto al posto della lente standard inclusa.



Quick 28W

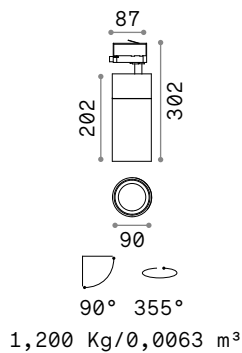

LED COB CITIZEN

CRI ≥ 80

Potenza	Angolo	Lumen	CCT	Finitura	Codice	€
28 W	30°	3550 lm	3000 K	Bianco	222615	185
				Nero	222622	185
		3800 lm	4000 K	Bianco	222639	185
				Nero	222646	185

CRI ≥ 90

Potenza	Angolo	Lumen	CCT	Finitura	Codice	€
28 W	30°	3100 lm	3000 K	Bianco	222653	185
				Nero	222660	185
		3300 lm	4000 K	Bianco	222677	185
				Nero	222684	185



FILTER HONEYCOMB



LENS*



SINGLE CONNECTION

Necessario	Angolo	Finitura	Codice	€
No		Nero	222714	10
No	18°	Trasparen.	222691	10
No	45°	Trasparen.	222707	10
No		Bianco	170145	27
		Nero	170152	27



Light beam: ACCENT

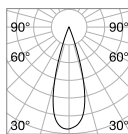

m	lx	Øm
1	8760	0,55
2	2190	1,11
3	973	1,67
4	547	2,22
5	350	2,78



CRI ≥ 80 28W 30° 3550lm 3000K

* La lente deve essere ordinata contestualmente al prodotto e verrà montata nel prodotto al posto della lente standard inclusa.



Smile

Proiettore cilindrico in alluminio (estrusione + lavorazione CNC + forgiatura) adatto per installazione su binario trifase.

Verniciatura a polveri in bianco o nero, testata girevole 350° e orient. 90°; il driver di alimentazione è incluso e trova alloggio nel corpo cilindrico del proiettore stesso.

Sorgente luminosa con tecnologia COB LED integrato, disponibile con una temperatura di colore di 3000 K o 4000 K e con indice di resa cromatica fino a 90; binning iniziale ≤4-Step MacAdam; ottica a fascio simmetrico con tre diversi angoli di emissione e controllo dell'abbagliamento (UGR <19). Montaggio e smontaggio senza utensili. Protezione IP20; classe isolamento II; durata utile LED 50.000h L70B50. Ideale per l'illuminazione di grandi ambienti dove viene richiesta ampia flessibilità e resa cromatica, ad esempio spazi MUSEALI, COMMERCIALI e RETAIL.



Articolo con UGR <19.

Sorgente	LED COB
Potenza	15W / 20W / 30W
Driver incluso	On/Off
Driver disponibili	No
Binario	Trifase (standard Eutrac)
CCT	3000 K / 4000 K
CRI	≥82 / ≥92
Durata LED	50.000h
Classe isolamento	II
IP	20
Materiale	Alluminio
Garanzia	5 anni



[Link - Pagina 718](#)





Smile 15W

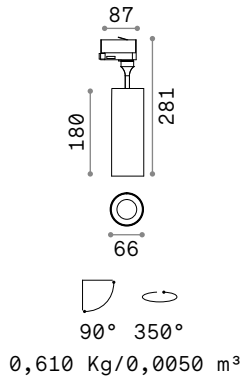

LED COB PHILIPS Driver TRIDONIC ON/OFF incluso

CRI ≥ 82

Potenza	Angolo	Lumen	CCT	Finitura	Codice	€
15W	24°	2050 lm	3000 K	Bianco	189574	120
				Nero	189581	120
		2250 lm	4000 K	Bianco	189611	120
				Nero	189628	120
	36°	2050 lm	3000 K	Bianco	189758	120
				Nero	189765	120
		2250 lm	4000 K	Bianco	189796	120
				Nero	189802	120
	50°	2050 lm	3000 K	Bianco	189932	120
				Nero	189949	120
		2250 lm	4000 K	Bianco	189956	120
				Nero	189963	120

CRI ≥ 92

Potenza	Angolo	Lumen	CCT	Finitura	Codice	€
15W	24°	1700 lm	3000 K	Bianco	189598	120
				Nero	189604	120
	36°	1700 lm	3000 K	Bianco	189772	120
				Nero	189789	120
	50°	1700 lm	3000 K	Bianco	189970	120
				Nero	189987	120



FILTER HONEYCOMB

SINGLE CONNECTION

Necessario	Driver	Finitura	Codice	€
No		Nero	189536	6
No	On/Off	Bianco	170145	27
		Nero	170152	27



Light beam: SPOT

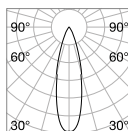

m	lx	øm
1	4362	0,47
2	1090	0,94
3	484	1,41
4	272	1,88
5	174	2,35



CRI ≥ 82 15W 24° 2050lm 3000K



Light beam: ACCENT

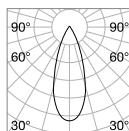

m	lx	øm
1	2923	0,64
2	730	1,29
3	324	1,94
4	182	2,58
5	116	3,23



CRI ≥ 82 15W 36° 2050lm 3000K



Light beam: WIDE

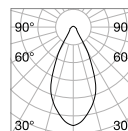

m	lx	øm
1	1611	0,89
2	402	1,79
3	179	2,69
4	100	3,59
5	64	4,49



CRI ≥ 82 15W 50° 2050lm 3000K



Smile 20W

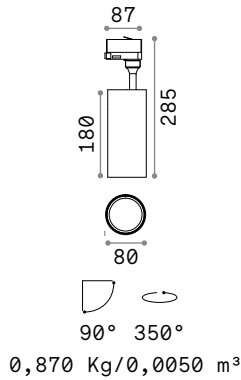

LED COB PHILIPS Driver TRIDONIC ON/OFF incluso

CRI ≥ 82

Potenza	Angolo	Lumen	CCT	Finitura	Codice	€
20 W	24°	3000 lm	3000 K	Bianco	189635	135
				Nero	189642	135
		3150 lm	4000 K	Bianco	189673	135
				Nero	189680	135
	36°	3000 lm	3000 K	Bianco	189819	135
				Nero	189826	135
		3150 lm	4000 K	Bianco	189857	135
				Nero	189864	135
	50°	3000 lm	3000 K	Bianco	189994	135
				Nero	190006	135
		3150 lm	4000 K	Bianco	190013	135
				Nero	190020	135

CRI ≥ 92

Potenza	Angolo	Lumen	CCT	Finitura	Codice	€
20 W	24°	2550 lm	3000 K	Bianco	189659	135
				Nero	189666	135
	36°	2550 lm	3000 K	Bianco	189833	135
				Nero	189840	135
	50°	2550 lm	3000 K	Bianco	190037	135
				Nero	190044	135



FILTER HONEYCOMB

SINGLE CONNECTION

Necessario	Driver	Finitura	Codice	€
No		Nero	190181	6
No	On/Off	Bianco	170145	27
		Nero	170152	27



Light beam: SPOT

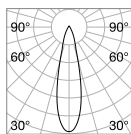

m	lx	cm
1	8787	0,42
2	2196	0,85
3	976	1,28
4	549	1,71
5	351	2,14



CRI ≥ 82 20W 24° 3000lm 3000K



Light beam: ACCENT

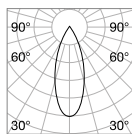

m	lx	cm
1	4526	0,64
2	1131	1,28
3	502	1,92
4	282	2,56
5	181	3,20



CRI ≥ 82 20W 36° 3000lm 3000K



Light beam: WIDE

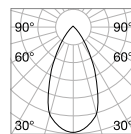

m	lx	cm
1	2657	0,93
2	664	1,87
3	295	2,81
4	166	3,75
5	106	4,69



CRI ≥ 82 20W 50° 3000lm 3000K



Smile 30W

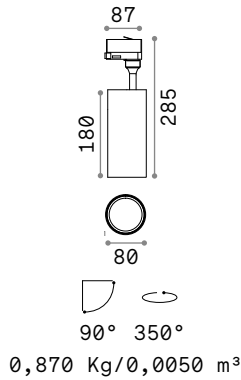

LED COB PHILIPS Driver TRIDONIC ON/OFF incluso

CRI ≥ 82

Potenza	Angolo	Lumen	CCT	Finitura	Codice	€
30W	24°	4000lm	3000K	Bianco	189697	150
				Nero	189703	150
		4200lm	4000K	Bianco	189734	150
				Nero	189741	150
	36°	4000lm	3000K	Bianco	189871	150
				Nero	189888	150
		4200lm	4000K	Bianco	189895	150
				Nero	189901	150
	50°	4000lm	3000K	Bianco	190051	150
				Nero	190068	150
		4200lm	4000K	Bianco	190075	150
				Nero	190082	150

CRI ≥ 92

Potenza	Angolo	Lumen	CCT	Finitura	Codice	€
30W	24°	3500lm	3000K	Bianco	189710	150
				Nero	189727	150
	36°	3500lm	3000K	Bianco	189918	150
				Nero	189925	150
	50°	3500lm	3000K	Bianco	190099	150
				Nero	190105	150



FILTER HONEYCOMB

SINGLE CONNECTION

Necessario	Driver	Finitura	Codice	€
No		Nero	190181	6
No	On/Off	Bianco	170145	27
		Nero	170152	27



Light beam: SPOT

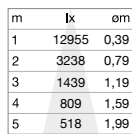
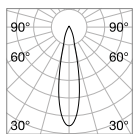

CRI ≥ 82 30W 24° 4000lm 3000K



Light beam: ACCENT

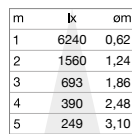
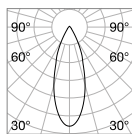

CRI ≥ 82 30W 36° 4000lm 3000K



Light beam: WIDE

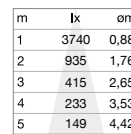
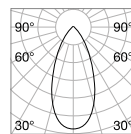

CRI ≥ 82 30W 50° 4000lm 3000K



Fox new

Proiettore cilindrico in alluminio estruso, adatto per installazione su binario trifase. Verniciatura a polveri in bianco, nero oppure ottone satinato, testata girevole 350° e orientabile fino a 90°; il driver di alimentazione è incluso e trova alloggiamento nel corpo cilindrico del proiettore stesso. Disponibile anche in versione dimmerabile 1-10 V o DALI. Sorgente luminosa con tecnologia COB LED integrato, disponibile in tre diverse potenze con una temperatura di colore di 3000 K o 4000 K e con indice di resa cromatica fino a 90; binning iniziale ≤3-Step MacAdam; ottica simmetrica a fascio di apertura medio. Montaggio e smontaggio senza utensili. Protezione IP20; durata utile LED 30.000 h L70B50. Ideale per l'illuminazione di piccoli e medi ambienti dove vengono richiesti ampia flessibilità di disposizione, ad esempio in spazi COMMERCIALI e RETAIL, e un rapporto ottimale tra prestazioni e prezzo.

Sorgente	LED COB
Potenza	8W / 15W / 25W
Driver incluso	On/Off / 1-10V / DALI
Driver disponibili	No
Binario	Trifase (standard Eutrac)
MacAdam	SDCM 3
CCT	3000 K / 4000 K
CRI	≥80 / ≥90
Durata LED	30.000 h
Classe isolamento	On-Off I, 1-10V / DALI II
IP	20
Materiale	Alluminio
Garanzia	5 anni



[Link - Pagina 718](#)





Hot Drinks

Espresso	1.30	2.00
Espresso macchiato	1.00	2.30
Americano	1.00	
Cappuccino	2.10	
Caffè latte	2.20	
Flat White	2.00	
Chai Latte	2.00	
Hot Chocolate	2.20	
Hot milk w. Honey	2.00	

Cold Drinks

Mineral Water	0.33l	2.00
Afri Cola	0.2 l	2.00
Seesüßigkeits-Limonade	0.33l	2.40
... cherry, pear, orange		
Homemade Tamarind-Limonade	0.33l	3.00
Juice	0.2 l	2.00
... apple, melon		
Juice w. sparkling Water	0.33l	2.80

Lemonade	0.33l	2.10
Club Mate	0.33l	2.20

Homemade Gingerbeer (no alcohol)	0.35l	3.00
----------------------------------	-------	------

extra egg
soy-milk
whipped cream

orange juice

Red-Mango-Zinger, Honey-Vanilla-Creamsicle, Sticky-Tama, Tension-Tamer, Antioxidis Green, Black-Cherry-Berry, Apple-Cinnamon, Chai Bengal Spice

Fresh Tea 2.50
Ginger, Pfaff or Lemn.

Fox 8W

LED COB BRIDGELUX Driver incluso

CRI ≥ 80

Potenza	Angolo	Driver	Lumen	CCT	Finitura	Codice	€
8W	41°	On-Off	1050 lm	3000 K	Bianco	250410	49
					Nero	250403	49
					Ottone	283920	49
			1100 lm	4000 K	Bianco	271453	49
					Nero	271446	49

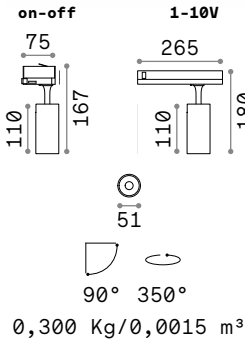

CRI ≥ 90

Potenza	Angolo	Driver	Lumen	CCT	Finitura	Codice	€
8W	41°	On-Off	850 lm	3000 K	Bianco	285368	49
					Nero	285351	49
					Bianco	322339	49 new
		1-10V	850 lm	3000 K	Nero	322322	49 new
					Bianco	302546	85
					Nero	302539	85



LENS*

SINGLE CONNECTION

Necessario	Angolo	Driver	Finitura	Codice	€
No	23°		Trasparen.	302744	5
No		On/Off	Bianco	170145	27
			Nero	170152	27



Light beam: ACCENT

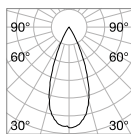

m	lx	Øm
1	2067	0,77
2	517	1,54
3	230	2,30
4	129	3,07
5	83	3,84



CRI ≥ 80 8W 41° 10001m 3000K

* La lente deve essere ordinata contestualmente al prodotto e verrà montata nel prodotto al posto della lente standard inclusa.



Fox 15W

LED COB BRIDGELUX Driver incluso

CRI ≥ 80

Potenza	Angolo	Driver	Lumen	CCT	Finitura	Codice	€
15W	41°	On-Off	1700 lm	3000 K	Bianco	250434	55
					Nero	250427	55
					Ottone	283937	55
			1750 lm	4000 K	Bianco	267784	55
					Nero	267777	55

CRI ≥ 90

Potenza	Angolo	Driver	Lumen	CCT	Finitura	Codice	€	
15W	41°	On-Off	1550 lm	3000 K	Bianco	285382	55	
					Nero	285375	55	
					1600 lm	4000 K	Bianco	322360
			Nero	322346	55 <i>new</i>			
			1-10V	1550 lm	3000 K	Bianco	302560	90
						Nero	302553	90
		DALI	1550 lm	3000 K	Bianco	302584	110	
					Nero	302577	110	

Necessario	Angolo	Driver	Finitura	Codice	€
No	15°		Trasparen.	302751	5
No		On/Off	Bianco	170145	27
			Nero	170152	27

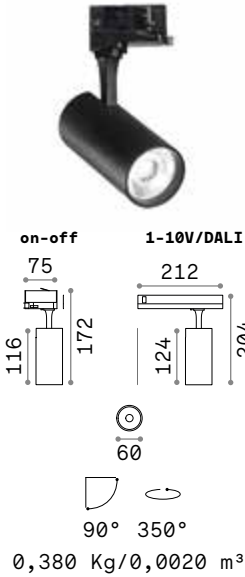

LENS*



SINGLE CONNECTION



Light beam: ACCENT

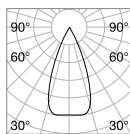

m	lx	Øm
1	3204	0,80
2	801	1,60
3	356	2,40
4	200	3,20
5	128	4,00



CRI ≥ 80 15W 41° 1700lm 3000K

* La lente deve essere ordinata contestualmente al prodotto e verrà montata nel prodotto al posto della lente standard inclusa.



Fox 25W

LED COB BRIDGELUX Driver incluso

CRI ≥ 80

Potenza	Angolo	Driver	Lumen	CCT	Finitura	Codice	€
25 W	35°	On-Off	2950 lm	3000 K	Bianco	250458	60
					Nero	250441	60
		1-10V/DALI	3050 lm	4000 K	Bianco	283944	60
					Nero	267791	60
					Bianco	267807	60
					Nero	267791	60

CRI ≥ 90

Potenza	Angolo	Driver	Lumen	CCT	Finitura	Codice	€	
25 W	35°	On-Off	2550 lm	3000 K	Bianco	285405	60	
					Nero	285399	60	
			1-10V	2700 lm	4000 K	Bianco	322391	60 new
						Nero	322377	60 new
				2550 lm	3000 K	Bianco	302607	100
						Nero	302591	100
		DALI	2550 lm	3000 K	Bianco	302621	115	
					Nero	302614	115	

Necessario	Angolo	Driver	Finitura	Codice	€
No	15°		Trasparen.	302768	5
No		On/Off	Bianco	170145	27
			Nero	170152	27

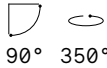
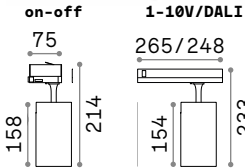

0,540 Kg/0,0027 m³



LENS*



SINGLE CONNECTION



Light beam: ACCENT

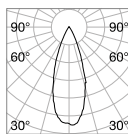

m	lx	Øm
1	8140	0,61
2	2035	1,22
3	904	1,82
4	509	2,43
5	326	3,04



CRI ≥ 80 25W 35° 2950lm 3000K

* La lente deve essere ordinata contestualmente al prodotto e verrà montata nel prodotto al posto della lente standard inclusa.



Eos new

Proiettore cilindrico in alluminio estruso con ottica simmetrica e fascio di apertura variabile da stretto ad ampio (20°-55°), adatto per installazione su binario trifase. Verniciatura a polveri in bianco o nero, testata girevole 355° e orientabile fino a 90°; il driver di alimentazione è incluso e trova alloggiamento nel corpo cilindrico del proiettore stesso. Disponibile anche in versione dimmerabile 1-10 V o DALI. Sorgente luminosa con tecnologia COB LED integrato, disponibile in due diverse potenze con una temperatura di colore di 3000 K e 4000 K e con indice di resa cromatica ≥ 90 ; binning iniziale ≤ 3 Step MacAdam. Montaggio, smontaggio e regolazione dell'apertura del fascio senza utensili. Protezione IP20; durata utile LED 30.000 h L70B50. Ideale per l'illuminazione di grandi ambienti dove viene richiesta ampia flessibilità e alta resa cromatica, ad esempio aree ESPOSITIVE, spazi MUSEALI e RETAIL.

Sorgente	LED COB
Potenza	15W / 25W
Driver incluso	On/Off / 1-10V/ DALI
Driver disponibili	No
Binario	Trifase (standard Eutrac)
MacAdam	SDCM 3
CCT	3000 K / 4000 K
CRI	≥ 90
Durata LED	30.000 h
Classe isolamento	On-Off I, 1-10V / DALI II
IP	20
Materiale	Alluminio
Garanzia	5 anni



[Link - Pagina 718](#)

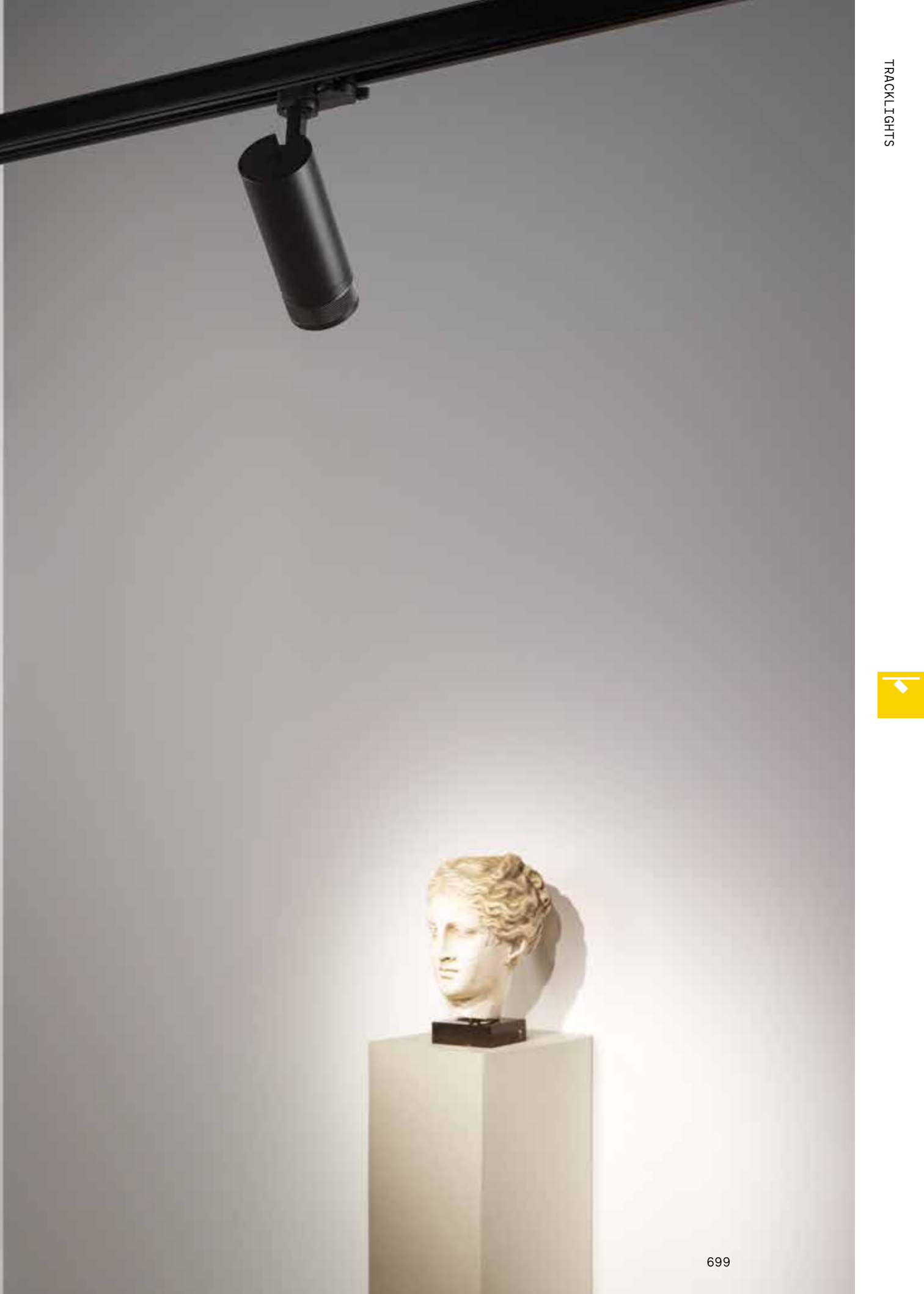

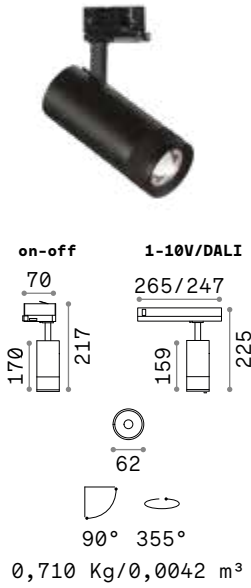

LED COB BRIDGELUX Driver incluso

Potenza	Angolo	Driver	Lumen	CCT	Finitura	Codice	€
15 W	20-55°	On-Off	1550 lm	3000 K	Bianco	286594	73
					Nero	276182	73
			1600 lm	4000 K	Bianco	322094	73 <i>new</i>
					Nero	322087	73 <i>new</i>
		1-10V	1550 lm	3000 K	Bianco	302959	116
					Nero	302942	116
		DALI	1550 lm	3000 K	Bianco	302997	135
					Nero	302980	135

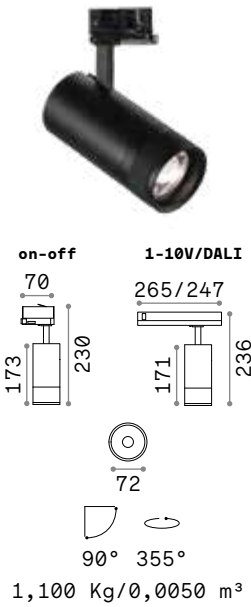

LED COB BRIDGELUX Driver incluso

Potenza	Angolo	Driver	Lumen	CCT	Finitura	Codice	€
25 W	20-55°	On-Off	2250 lm	3000 K	Bianco	286600	92
					Nero	276243	92
			2700 lm	4000 K	Bianco	322124	92 <i>new</i>
					Nero	322100	92 <i>new</i>
		1-10V	2250 lm	3000 K	Bianco	302973	135
					Nero	302966	135
		DALI	2250 lm	3000 K	Bianco	303017	155
					Nero	303000	155



SINGLE CONNECTION

Necessario	Angolo	Driver	Finitura	Codice	€
No		On/Off	Bianco	170145	27
			Nero	170152	27

Light beam: from SPOT to WIDE

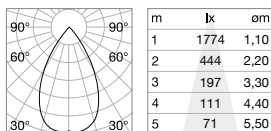

CRI≥90 15W 20-55° 1550lm 3000K

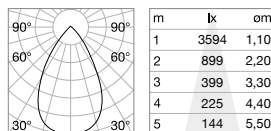

CRI≥90 25W 20-55° 3000lm 3000K





Pov



Sorgente	LED COB	CRI	≥95
Potenza	22W	Durata LED	30.000 h
Driver incluso	On/Off	Classe isolamento	II
Driver disponibili	No	IP	20
Binario	Trifase (standard Eutrac)	Materiale	Alluminio
MacAdam	SDCM 3	Garanzia	5 anni
CCT	3000 K		

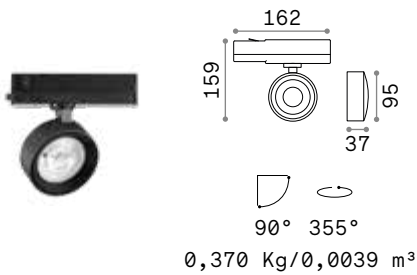

LED COB CREE Driver PHILIPS ON/OFF incluso

Potenza	Angolo	Lumen	CCT	Finitura	Codice	€
22 W	36°	2000 lm	3000 K	Bianco	296340	135
				Nero	296333	135

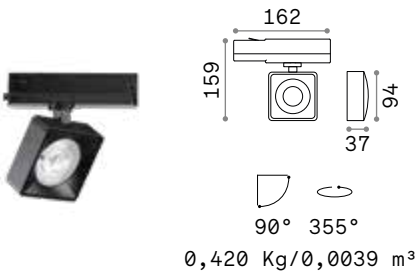

LED COB CREE Driver PHILIPS ON/OFF incluso

Potenza	Angolo	Lumen	CCT	Finitura	Codice	€
22 W	36°	2000 lm	3000 K	Bianco	296364	135
				Nero	296357	135



[Link - Pagina 718](#)



Light beam: ACCENT

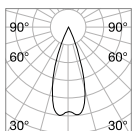

m	lx	Øm
1	3646	0,65
2	911	1,30
3	405	1,90
4	228	2,60
5	146	3,20



CRI≥95 22W 36° 1750lm 3000K

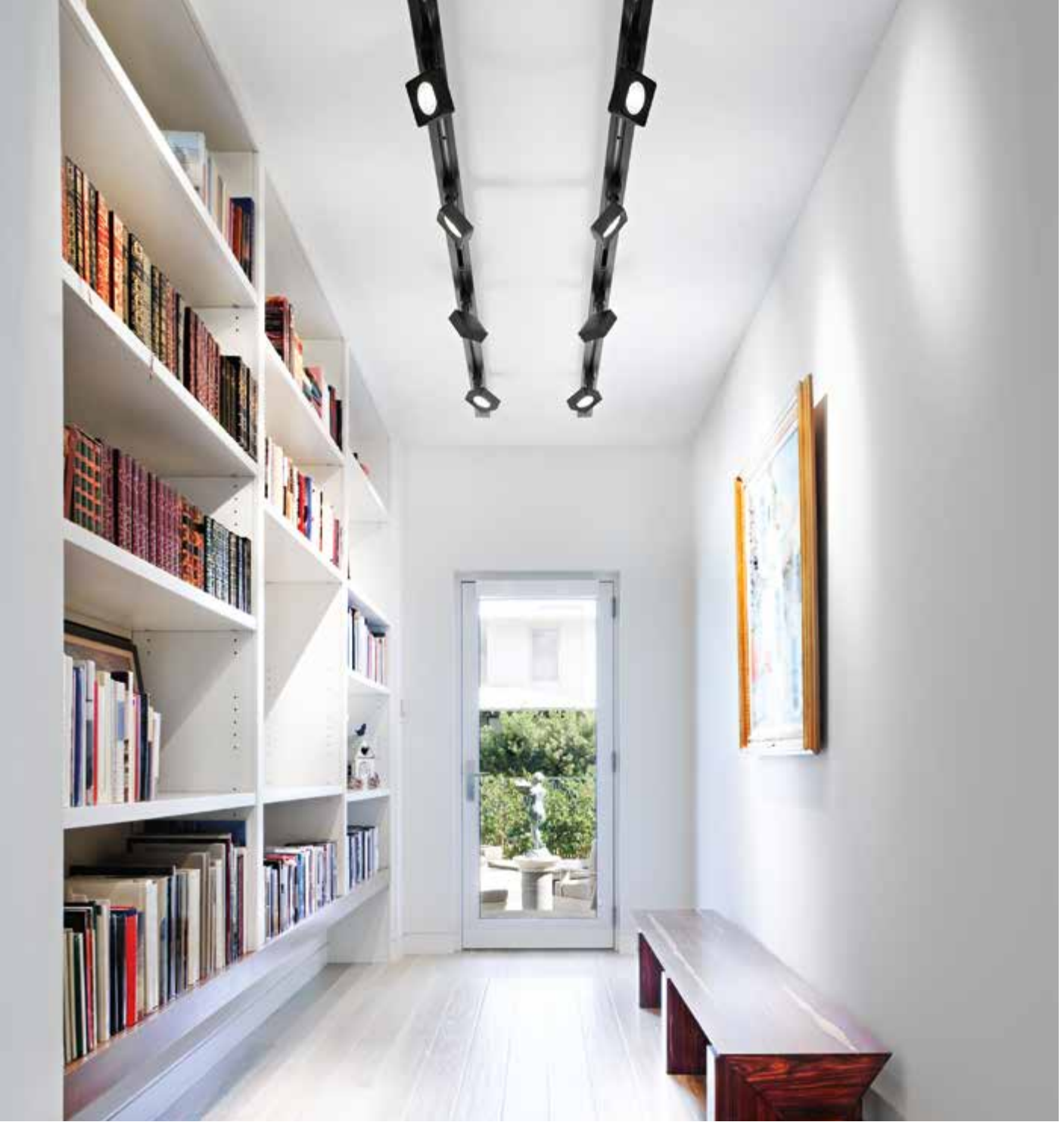



Spot - Mouse Track

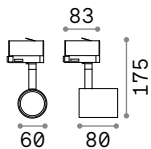

0,250 Kg/0,0016 m³

GU10 Non inclusa - Lampadina consigliata 108292

Potenza	Finitura	Codice	€
max 50W	Bianco	229706	47
	Nero	229720	47
	Ottone	269634	47



P. 324 P. 422

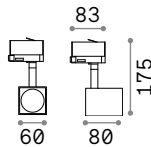

0,300 Kg/0,0027 m³

GU10 Non inclusa - Lampadina consigliata 108292

Potenza	Finitura	Codice	€
max 50W	Bianco	229768	44
	Nero	229782	44



P. 324 P. 422



SINGLE CONNECTION

Necessario	Driver	Finitura	Codice	€
No	On/Off	Bianco	170145	27
		Nero	170152	27



Link - Pagina 718



Glim Track

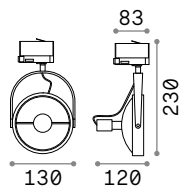

0,320 Kg/0,0180 m³

GU10 Lampadine LED GU10 10W 3000 K incluse. Cod. **189031**

IP20

Potenza	Finitura	Codice	€
max 50W	Bianco	229676	75
	Nero	229683	75



P. 329



SINGLE CONNECTION

Necessario	Driver	Finitura	Codice	€
No	On/Off	Bianco	170145	27
		Nero	170152	27



Link - Pagina 718



Byte

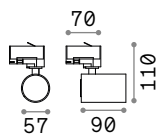

0,200 Kg/0,0013 m³

GU10 Lampadine LED GU10 7W 3000 K incluse. Cod. 123943



Potenza	Finitura	Codice	€
max 28W	Bianco	274508	36
	Nero	274515	36



SINGLE CONNECTION

Necessario	Driver	Finitura	Codice	€
No	On/Off	Bianco	170145	27
		Nero	170152	27



Link - Pagina 718



Byte Led new

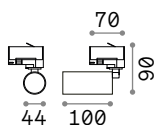

0,310 Kg/0,0007 m³

LED COB CITIZEN Driver ON/OFF incluso

⊕ IP20 CRI ≥90 50.000 h

Potenza	Angolo	Lumen	CCT	Finitura	Codice	€
8 W	34°	660 lm	3000 K	Bianco	316239	80 new
				Nero	316215	80 new



FILTER HONEYCOMB

Necessario	Driver	Finitura	Codice	€
No		Nero	323671	4 new



SINGLE CONNECTION

Necessario	Driver	Finitura	Codice	€
No	On/Off	Bianco	170145	27
		Nero	170152	27

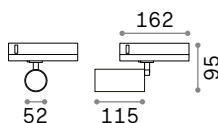

0,560 Kg/0,0024 m³

LED COB CITIZEN Driver ON/OFF incluso

⊕ IP20 CRI ≥90 50.000 h

Potenza	Angolo	Lumen	CCT	Finitura	Codice	€
22 W	30°	1850 lm	3000 K	Bianco	316192	125 new
				Nero	316208	125 new



Link - Pagina 718



GU10 Lampadine LED GU10 7W 3000 K incluse. Cod. **123943**

Potenza	Finitura	Codice	€
max 28W	Bianco	 231662	83
	Nero	 231631	83

0,930 Kg/0,0037 m³



SINGLE CONNECTION

Necessario	Driver	Finitura	Codice	€
No	On/Off	Bianco	 170145	27
		Nero	 170152	27



[Link - Pagina 718](#)



Display

Proiettore lineare in alluminio adatto per installazione su binario trifase (standard Eutrac), disponibile in tre differenti lunghezze e con verniciatura a polveri in finitura bianca o nera. Il driver di alimentazione integrato è alloggiato all'interno del binario per minimizzare l'ingombro del prodotto visibile. Disponibile nel modello WIDE con ottica piatta e diffondente in PMMA satinato, nel modello UGR con diffusore in PMMA microprismatizzato per il controllo dell'abbagliamento e nel modello ACCENT con riflettori neri (UGR < 16). Sorgenti LED integrate; disponibile in CCT 3000 K e 4000 K; CRI ≥ 80; durata utile LED 50.000 h L70B50; montaggio e smontaggio senza utensili. Adatto per l'illuminazione di UFFICI, spazi COMMERCIALI e aree ESPOSITIVE, ideale in combinazione con altri proiettori da binario a luce focalizzata.

PRO Prodotto ad alto contenuto tecnologico, elevata qualità dei materiali, destinato ad uso professionale.

UGR Articolo con UGR <16 (Accent), <22 (UGR).

Sorgente	LED SMD
Potenza	14W / 40W
Driver incluso	On/Off
Driver disponibili	No
Binario	Trifase (standard Eutrac)
MacAdam	SDCM 3
CCT	3000 K / 4000 K
CRI	≥80
UGR	<16 (Accent) / <22 (UGR)
Durata LED	50.000 h
Classe isolamento	II
IP	20
Materiale	Alluminio
Garanzia	5 anni



[Link - Pagina 718](#)





Display Accent

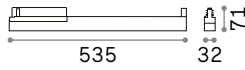

0,400 Kg/0,0064 m³

LED SMD SAMSUNG Driver ON/OFF incluso - UGR <16

Potenza	Angolo	Lumen	CCT	Finitura	Codice	€
14 W	60°	1800 lm	3000 K	Bianco	283593	210
				Nero	283609	210
		1900 lm	4000 K	Bianco	283616	210
				Nero	283623	210

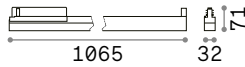

1,120 Kg/0,0112 m³

LED SMD SAMSUNG Driver ON/OFF incluso - UGR <16

Potenza	Angolo	Lumen	CCT	Finitura	Codice	€
28 W	60°	3500 lm	3000 K	Bianco	283524	330
				Nero	276267	330
		3700 lm	4000 K	Bianco	283531	330
				Nero	283548	330

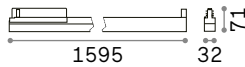

1,570 Kg/0,0173 m³

LED SMD SAMSUNG Driver ON/OFF incluso - UGR <16

Potenza	Angolo	Lumen	CCT	Finitura	Codice	€
40 W	60°	5300 lm	3000 K	Bianco	283555	455
				Nero	283562	455
		5600 lm	4000 K	Bianco	283579	455
				Nero	283586	455



Light beam: ACCENT

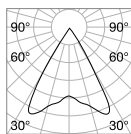

m	lx	Øm
1	1330	1,20
2	332	2,40
3	148	3,50
4	83	4,70
5	53	5,90

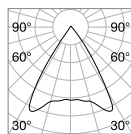

m	lx	Øm
1	2453	1,30
2	613	2,50
3	273	3,80
4	153	5,00
5	96	6,30

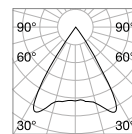

m	lx	Øm
1	3598	1,30
2	900	2,50
3	400	3,80
4	225	5,00
5	144	6,30



CRI≥80 14W 60° 1800lm 3000K

CRI≥80 28W 60° 3500lm 3000K

CRI≥80 40W 60° 5300lm 3000K



Display Accent 535 mm



Display Accent 1065 mm



Display Accent 1595 mm



Display Wide

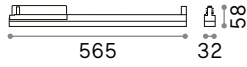

0,420 Kg/0,0067 m³

LED SMD SAMSUNG Driver ON/OFF incluso

Potenza	Angolo	Lumen	CCT	Finitura	Codice	€
21W	125°	2700 lm	3000 K	Bianco	283753	175
				Nero	283760	175
		2850 lm	4000 K	Bianco	276274	175
				Nero	283777	175

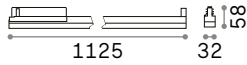

0,770 Kg/0,0124 m³

LED SMD SAMSUNG Driver ON/OFF incluso

Potenza	Angolo	Lumen	CCT	Finitura	Codice	€
40W	125°	5700 lm	3000 K	Bianco	283722	265
				Nero	283050	265
		5850 lm	4000 K	Bianco	283739	265
				Nero	283746	265



Light beam: WIDE

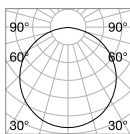

m	lx	Øm
1	473	5,20
2	118	6,50
3	53	9,70
4	30	13,00
5	19	16,00

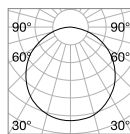

m	lx	Øm
1	897	3,10
2	224	6,10
3	100	9,20
4	56	12,00
5	36	15,00



CRI≥80 21W 125° 2700lm 3000K

CRI≥80 40W 125° 5700lm 3000K



Display Wide 565 mm



Display Wide 1125 mm



Display UGR

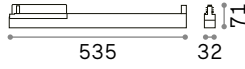

0,400 Kg/0,0064 m³

LED SMD SAMSUNG Driver ON/OFF incluso - UGR <22

Potenza	Angolo	Lumen	CCT	Finitura	Codice	€
14 W	70°	2000 lm	3000 K	Bianco	283685	185
				Nero	283692	185
		2100 lm	4000 K	Bianco	283708	185
				Nero	283715	185

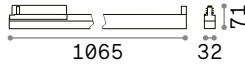

1,120 Kg/0,0112 m³

LED SMD SAMSUNG Driver ON/OFF incluso - UGR <22

Potenza	Angolo	Lumen	CCT	Finitura	Codice	€
27 W	70°	4000 lm	3000 K	Bianco	283647	290
				Nero	283630	290
		4300 lm	4000 K	Bianco	276281	290
				Nero	283258	290

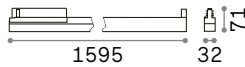

1,570 Kg/0,0173 m³

LED SMD SAMSUNG Driver ON/OFF incluso - UGR <22

Potenza	Angolo	Lumen	CCT	Finitura	Codice	€
40 W	70°	6050 lm	3000 K	Bianco	283654	410
				Nero	283067	410
		6450 lm	4000 K	Bianco	283661	410
				Nero	283678	410



Light beam: WIDE

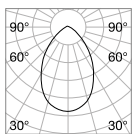

m	lx	Øm
1	854	1,40
2	213	2,80
3	95	4,20
4	53	5,70
5	34	7,10



CRI≥80 14W 70° 2000lm 3000K

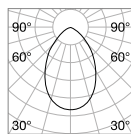

m	lx	Øm
1	1636	1,40
2	409	2,80
3	182	4,20
4	102	5,70
5	65	7,10



CRI≥80 27W 70° 4000lm 3000K

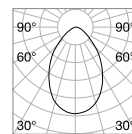

m	lx	Øm
1	2419	1,40
2	605	2,80
3	269	4,20
4	151	5,70
5	97	7,10



CRI≥80 40W 70° 6050lm 3000K

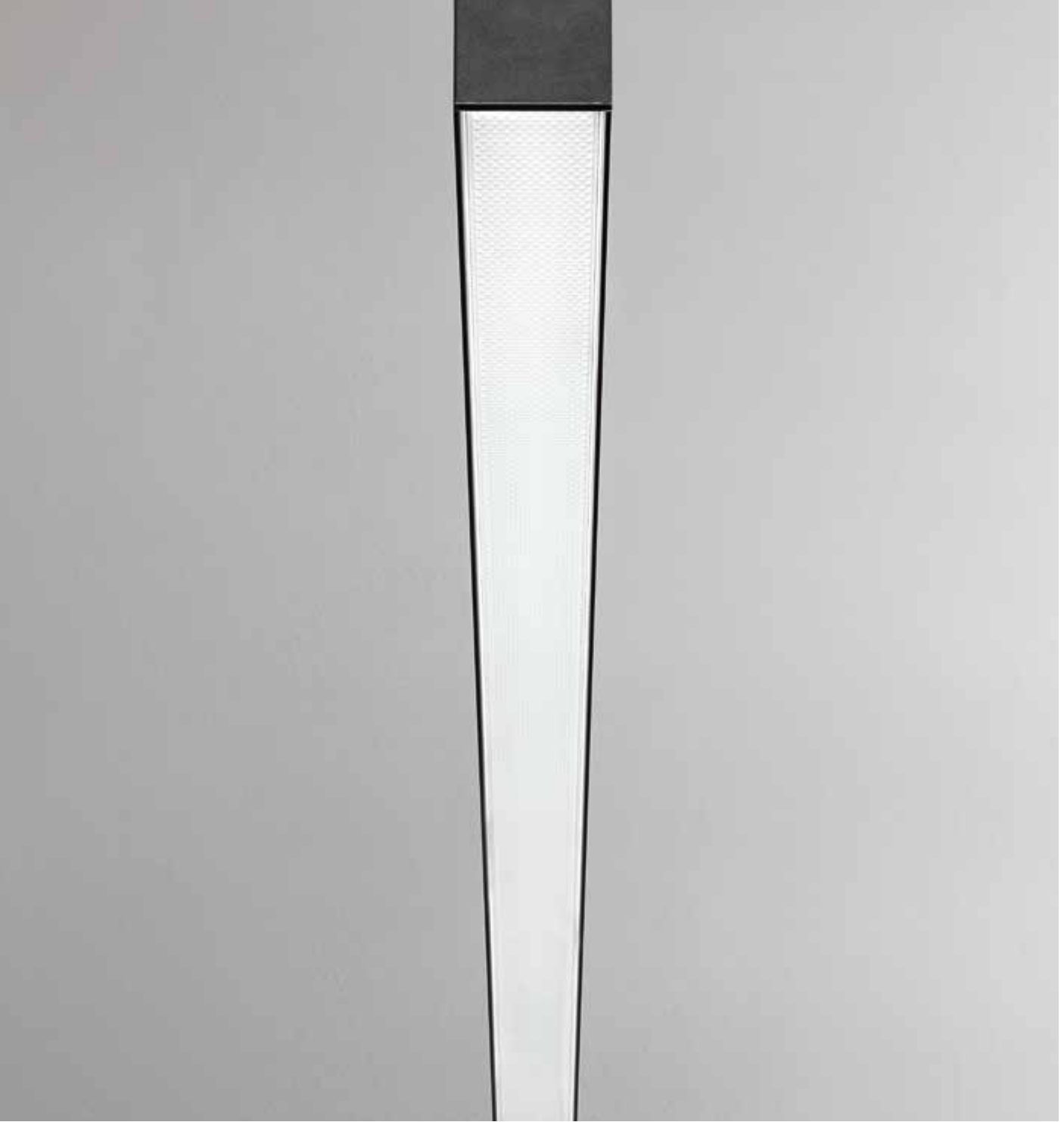

Display UGR 535 mm



Display UGR 1065 mm



Display UGR 1595 mm



Link **new**

Profilo di alluminio estruso per binari elettrificati trifase; verniciatura a polveri in bianco o nero, ottimizzato per proiettori standard Eutrac; disponibile nelle versioni a plafone, a sospensione oppure a incasso a filo su soffitti di cartongesso; adatto a sistemi di file continue, moduli standard da 2000 mm o 3000 mm. Ideale per l'installazione in grandi ambienti dove viene richiesta grande flessibilità, ad esempio spazi MUSEALI, COMMERCIALI e RETAIL. Garanzia 5 anni.

Classe isolamento | I
IP | 20





Link Trimless On/Off

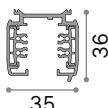
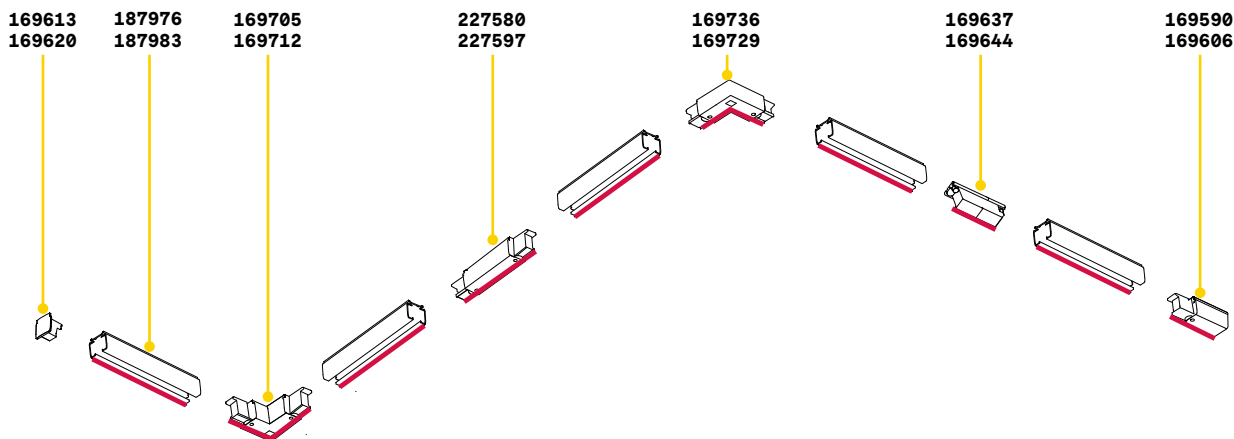

TRACK

Lunghezza	Peso	Volume	Finitura	Codice	€
1000 mm	0,94 Kg	0,0016 m ³	Bianco	243269	35
			Nero	243252	35
2000 mm	1,93 Kg	0,0032 m ³	Bianco	187976	65
			Nero	187983	65
3000 mm	2,87 Kg	0,0048 m ³	Bianco	187990	105
			Nero	188003	105



KIT SURFACE



SUSPENSION KIT



END CAP

Necessario	N° Cavi	Lunghezza cavi	Finitura	Codice	€
SI - 1Kit x 1000 mm			Bianco	169972	7
			Nero	169989	7
SI - 1Kit x 1000 mm	1	3000 mm	Bianco	242705	16
			Nero	243283	16
	1	5000 mm	Bianco	243245	18
			Nero	243238	18
SI			Bianco	169613	4
			Nero	169620	4



MAIN CONNECTOR END

0,060 Kg/0,0002 m³

169583	L	€ 16
169576	R	€ 16
169590	L	€ 16
169606	R	€ 16

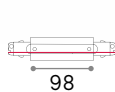

MAIN CONNECTOR MIDDLE

0,120 Kg/0,0004 m³

227580	€ 26
227597	€ 26

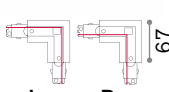

MAIN CONNECTOR CORNER

0,110 Kg/0,0005 m³

169705	L	€ 27
169712	R	€ 27
169736	L	€ 27
169729	R	€ 27

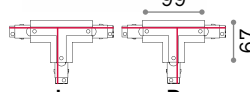

MAIN CONNECTOR T

0,190 Kg/0,0005 m³

324289	L	€ 45 ^{new}
324272	R	€ 45 ^{new}
324302	L	€ 45 ^{new}
324296	R	€ 45 ^{new}

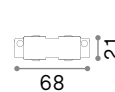

ELECTRIFIED CONNECTOR

0,030 Kg/0,0001 m³

169637	€ 8
169644	€ 8

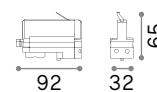

TRACK ADAPTOR

0,080 Kg/0,0002 m³

194257	€ 12
194301	€ 12

Link Trimless DALI - 1-10V

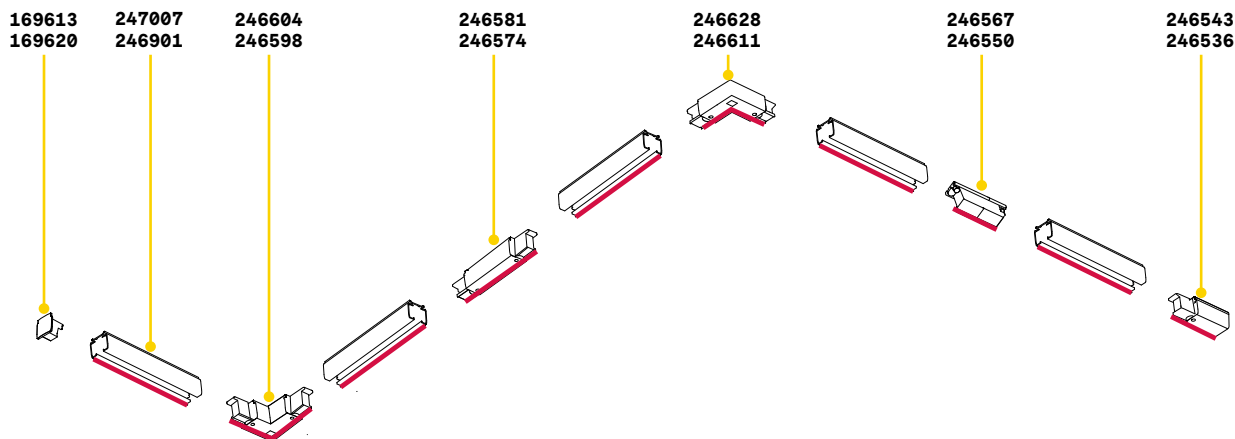

TRACK

Lunghezza	Peso	Volume	Finitura	Codice	€
1000 mm	0,94 Kg	0,0016 m³	Bianco	246468	38
			Nero	246451	38
2000 mm	1,93 Kg	0,0032 m³	Bianco	247007	75
			Nero	246901	75
3000 mm	2,87 Kg	0,0048 m³	Bianco	247625	115
			Nero	247618	115



KIT SURFACE



SUSPENSION KIT



END CAP

Necessario	N° Cavi	Lunghezza cavi	Finitura	Codice	€
SI - 1 Kit x 1000 mm			Bianco	169972	7
			Nero	169989	7
SI - 1 Kit x 1000 mm	1	3000 mm	Bianco	242705	16
			Nero	243283	16
	1	5000 mm	Bianco	243245	18
			Nero	243238	18
SI			Bianco	169613	4
			Nero	169620	4

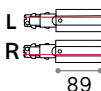

MAIN CONNECTOR END

0,079 Kg/0,0002 m³

246529	L	€ 19
246512	R	€ 19
246543	R	€ 19
246536	R	€ 19

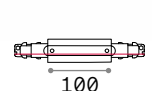

MAIN CONNECTOR MIDDLE

0,129 Kg/0,0004 m³

246581	€ 31
246574	€ 31

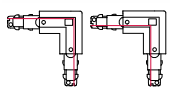

MAIN CONNECTOR CORNER

0,130 Kg/0,0006 m³

246604	L	€ 33
246598	L	€ 33
246628	R	€ 33
246611	R	€ 33

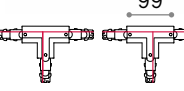

MAIN CONNECTOR T

0,200 Kg/0,0007 m³

324326	L	€ 60 new
324319	L	€ 60 new
324340	R	€ 60 new
324333	R	€ 60 new

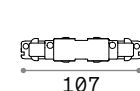

ELECTRIFIED CONNECTOR

0,050 Kg/0,0001 m³

246567	€ 12
246550	€ 12



TRACK ADAPTOR

0,063 Kg/0,0003 m³

246505	€ 20
246499	€ 20

Link Trim On/Off

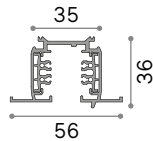
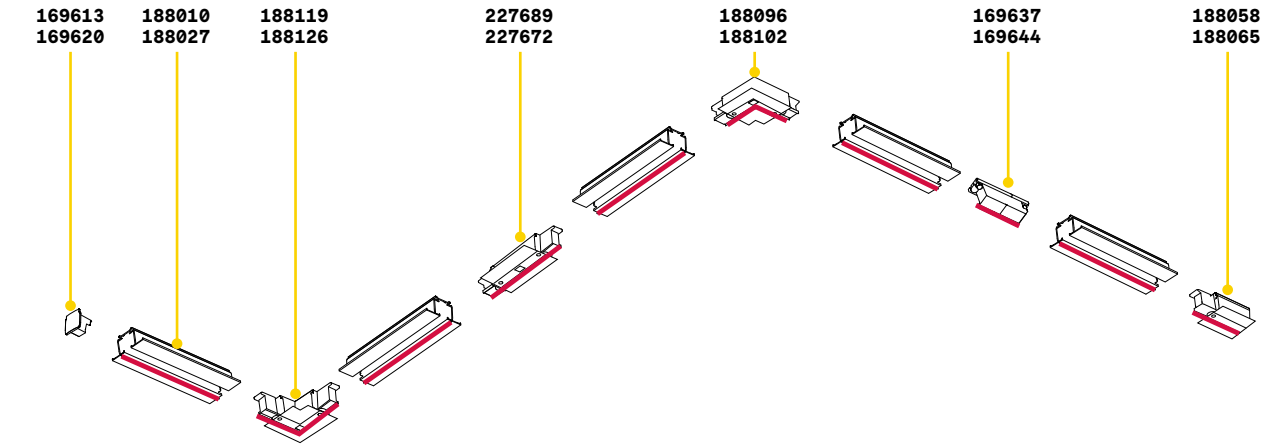

TRACK

Lunghezza	Peso	Volume	Finitura	Codice	€
2000 mm	1,92 Kg	0,0132 m ³	Bianco	188010	68
			Nero	188027	68



KIT RECESSED
END CAP

Necessario	Finitura	Codice	€
SI - 1 Kit x 1000 mm	Alluminio	188195	6
SI	Bianco	169613	4
	Nero	169620	4

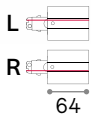

MAIN CONNECTOR END

0,070 Kg/0,0002 m³

188072 L € 18
188089 L € 18
188058 R € 18
188065 R € 18

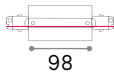

MAIN CONNECTOR MIDDLE

0,130 Kg/0,0004 m³

227689 € 29
227672 € 29

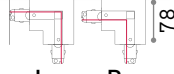

MAIN CONNECTOR CORNER

0,120 Kg/0,0006 m³

188119 L € 30
188126 L € 30
188096 R € 30
188102 R € 30



MAIN CONNECTOR T

0,200 Kg/0,0051 m³

324364 L € 48^{new}
324357 L € 48^{new}
324388 R € 48^{new}
324371 R € 48^{new}

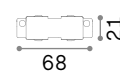

ELECTRIFIED CONNECTOR

0,030 Kg/0,0001 m³

169637 € 8
169644 € 8

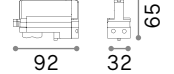

TRACK ADAPTOR

0,080 Kg/0,0002 m³

194257 € 12
194301 € 12

Link Trim DALI - 1-10V

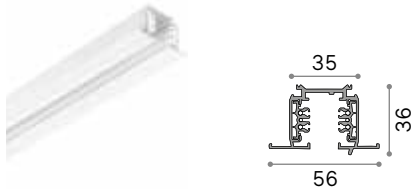
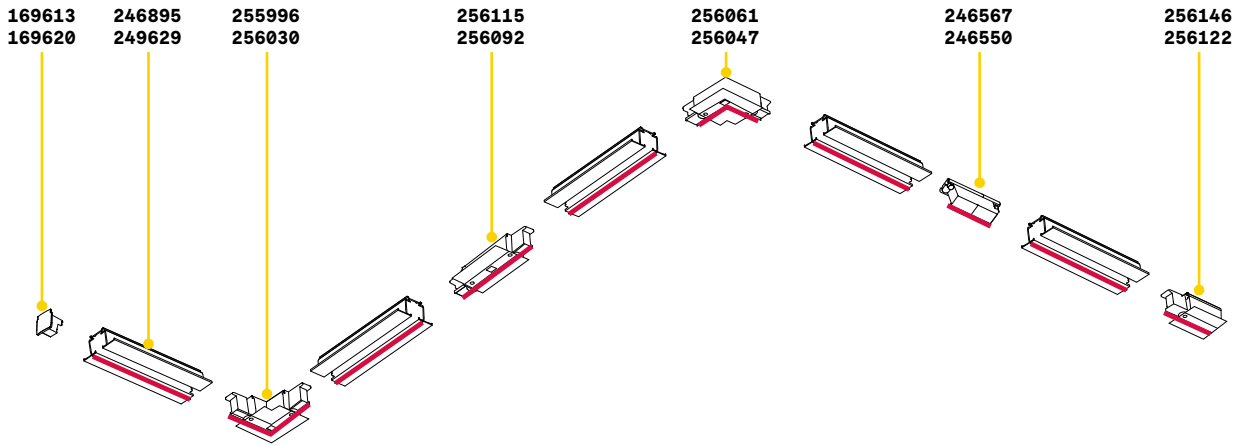

TRACK

Lunghezza	Peso	Volume	Finitura	Codice	€
2000 mm	2,11 Kg	0,0048 m ³	Bianco	246895	76
			Nero	249629	76



**KIT RECESSED
END CAP**

Necessario	Finitura	Codice	€
SI - 1 Kit x 1000 mm	Alluminio	188195	6
SI	Bianco	169613	4
	Nero	169620	4

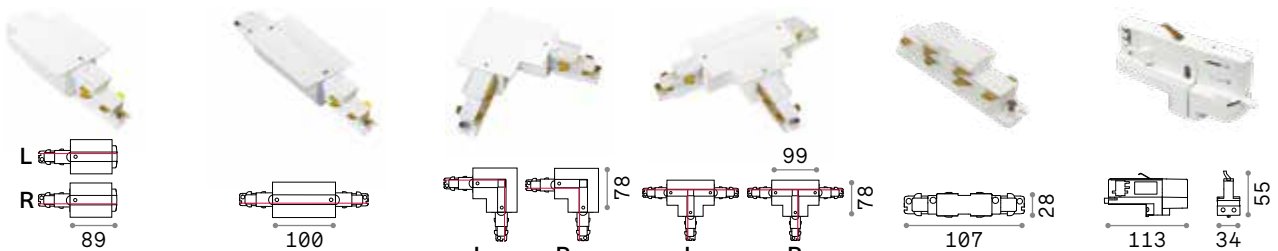

MAIN CONNECTOR END	MAIN CONNECTOR MIDDLE	MAIN CONNECTOR CORNER	MAIN CONNECTOR T	ELECTRIFIED CONNECTOR	TRACK ADAPTOR
0,089 Kg/0,0004 m ³	0,150 Kg/0,0005 m ³	0,150 Kg/0,0006 m ³	0,200 Kg/0,0051 m ³	0,050 Kg/0,0001 m ³	0,063 Kg/0,0003 m ³
256085 L € 21 256078 N L € 21 256146 R € 21 256122 N R € 21	256115 L € 34 256092 N € 34	256030 L € 36 255996 N L € 36 256061 R € 36 256047 N R € 36	324401 L € 63 new 324395 N L € 63 new 324425 R € 63 new 324418 N R € 63 new	246567 L € 12 246550 N € 12	246505 L € 20 246499 N € 20

































Interni

Lampade da incasso

Indice alfabetico

Basic	768
Basic IP65	774
Bento	734
Blues	800
Chill	797
Deep	766
Dynamic	740
Funky	798
Game	748
Groove	776
Jazz	798
Led Panel	784
Lika	319
Lika	786
Lounge	798
Nova	782
Off	762
One	756
Play	321
Play	780
Polka	802
Quark	760
Room-65	799
Samba	794
Soul	801
Swing	798
Virus	758
Walky	803
Zephyr	796
Zeus	726

Indice icone

 <small>new</small>			 <small>new</small>	
Zeus 726	Bento 734	Dynamic 740	Game 748	One 756
	 <small>new</small>			
Virus 758	Quark 760	Off 762	Deep 766	Basic 768
 <small>new</small>				
Basic IP65 774	Groove 776	Aura 778	Play 780	Nova 782
	 <small>new</small>			 <small>new</small>
Led Panel 784	Lika 786	Samba 794	Zephyr 796	Chill 797
				
Jazz 798	Swing 798	Lounge 798	Funky 798	Room-65 799
				
Blues 800	Soul 801	Soul 801	Polka 802	Walky 803

Zeus ^{new}

Sistema componibile di elementi ad incasso costituito da sorgente orientabile, riflettore e ghiera rotonda o quadrata, con lenti e accessori schermanti in opzione; finitura bianca e nera; ghiera disponibile in versione TRIM con cornice o TRIMLESS senza cornice per installazione in controsoffitti in cartongesso; due diversi angoli di emissione a scelta. Sorgente luminosa con tecnologia COB LED integrato, disponibile con una temperatura di colore di 2700 K, 3000 K o 4000K ed elevata resa cromatica CRI ≥ 90 ; classe isolamento II; durata utile LED 50.000 h L70B50. Disponibile anche in versione dimmerabile 1-10V, DALI e PUSH. Adatto nelle installazioni di ambienti interni del TERZIARIO e RETAIL.

PRO

Prodotto ad alto contenuto tecnologico, elevata qualità dei materiali, destinato ad uso professionale.

UGR

Articolo con UGR <19.

Sorgente	LED COB
Potenza	13W / 21W
Driver incluso	On/Off
Driver disponibili	1-10V / DALI / Push
MacAdam	SDCM 3
CCT	2700 K / 3000 K / 4000 K
CRI	≥ 90
UGR	<19
Durata LED	50.000 h
Classe isolamento	II
IP	20
Materiale	Alluminio
Garanzia	5 anni





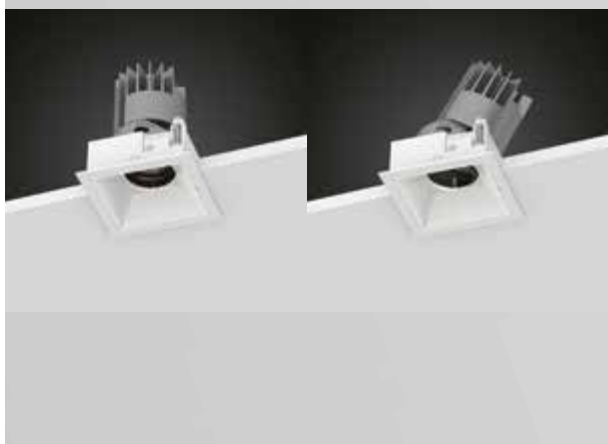

LENS 20°



FILTER HONEYCOMB

Necessario	Modello	Finitura	Codice	€
No	13 W	Trasparen.	323688	4 new
	21 W	Trasparen.	323985	6 new
No	13 W	Nero	323671	4 new
	21 W	Nero	323961	6 new

Zeus - Source

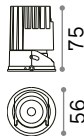
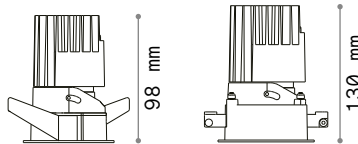

0,300 Kg/0,0014 m³

LED COB CITIZEN Necessario - Driver ON/OFF incluso

Potenza	Angolo	Lumen	CCT	Finitura	Codice	€
13W	40°	980 lm	2700 K	Grigio	324807	65 <small>new</small>
		1020 lm	3000 K	Grigio	324814	65 <small>new</small>
		1050 lm	4000 K	Grigio	324821	65 <small>new</small>

DIMMABLE DRIVER* Optional

	Potenza	Output	Misura (LxHxP)	Codice	€
1-10V	21W	350 mA	122x25x40 mm	324906	35 <small>new</small>
DALI/Push	20W	350 mA	120x29x51 mm	324913	70 <small>new</small>

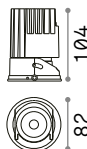

0,590 Kg/0,0029 m³

LED COB CITIZEN Necessario - Driver ON/OFF incluso

Potenza	Angolo	Lumen	CCT	Finitura	Codice	€
21W	40°	1850 lm	2700 K	Grigio	324838	105 <small>new</small>
		1900 lm	3000 K	Grigio	324845	105 <small>new</small>
		2100 lm	4000 K	Grigio	324852	105 <small>new</small>

DIMMABLE DRIVER* Optional

	Potenza	Output	Misura (LxHxP)	Codice	€
1-10V/Push	20W	500 mA	110x22x52 mm	324920	60 <small>new</small>
DALI/Push	20W	500 mA	120x29x51 mm	324937	70 <small>new</small>



Light beam: ACCENT

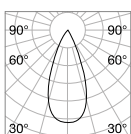

m	lx	øm
1	1714	0,76
2	429	1,50
3	190	2,30
4	107	3,10
5	69	3,80



CRI≥90 13W 40° 1020lm 3000K

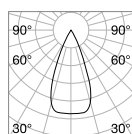

m	lx	øm
1	3174	0,81
2	794	1,60
3	353	2,40
4	198	3,20
5	127	4,00



CRI≥90 21W 40° 1900lm 3000K

* Gli alimentatori dimmerabili devono essere ordinati contestualmente al prodotto e verranno già inclusi all'interno degli apparecchi in sostituzione degli alimentatori on-off.
** Lente 40° inclusa.

Zeus Round

REFLECTOR Necessario

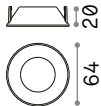
0,030 Kg/0,0003 m³

13 W

Finitura	Codice	€
Bianco	323589	8 <i>new</i>
Nero	323619	8 <i>new</i>
Oro	323602	8 <i>new</i>



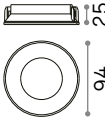

0,040 Kg/0,0007 m³

21 W

Finitura	Codice	€
Bianco	323763	12 <i>new</i>
Nero	323770	12 <i>new</i>
Oro	323794	12 <i>new</i>

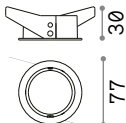
FRAME TRIM

① 70 mm
0,100 Kg/0,0005 m³

13 W

Finitura	Codice	€
Bianco	324869	15 <i>new</i>
Nero	323527	15 <i>new</i>



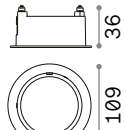

① 100 mm
0,130 Kg/0,0010 m³

21 W

Finitura	Codice	€
Bianco	324883	18 <i>new</i>
Nero	324005	18 <i>new</i>

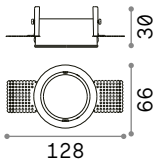
FRAME TRIMLESS

① 73 mm
0,120 Kg/0,0005 m³

13 W

Finitura	Codice	€
Bianco	323541	18 <i>new</i>

① 105 mm
0,160 Kg/0,0008 m³

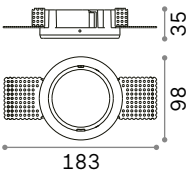
21 W

Finitura	Codice	€
Bianco	323725	35 <i>new</i>



Zeus Square

REFLECTOR Necessario

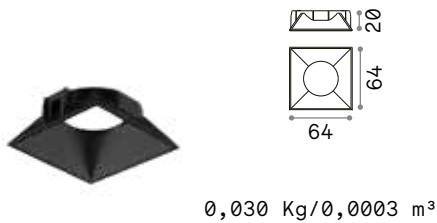

13 W

Finitura	Codice	€
Bianco	323633	8 <i>new</i>
Nero	323657	8 <i>new</i>
Oro	323640	8 <i>new</i>

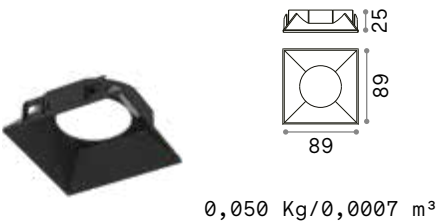

21 W

Finitura	Codice	€
Bianco	323800	12 <i>new</i>
Nero	323817	12 <i>new</i>
Oro	323831	12 <i>new</i>

FRAME TRIM

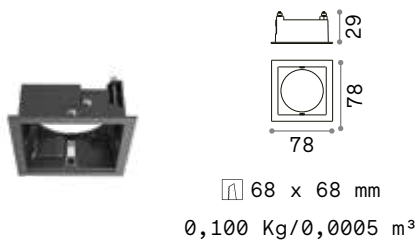

13 W

Finitura	Codice	€
Bianco	324876	15 <i>new</i>
Nero	323534	15 <i>new</i>

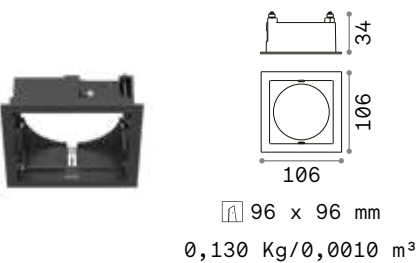

21 W

Finitura	Codice	€
Bianco	324890	18 <i>new</i>
Nero	323718	18 <i>new</i>

FRAME TRIMLESS

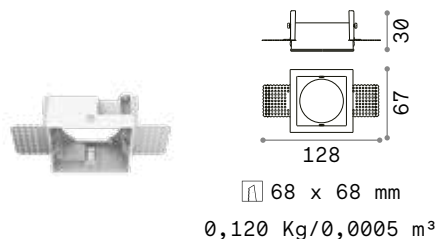

13 W

Finitura	Codice	€
Bianco	323558	18 <i>new</i>

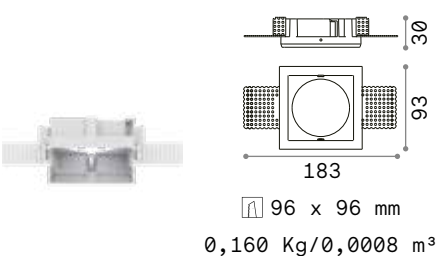

21 W

Finitura	Codice	€
Bianco	323732	35 <i>new</i>

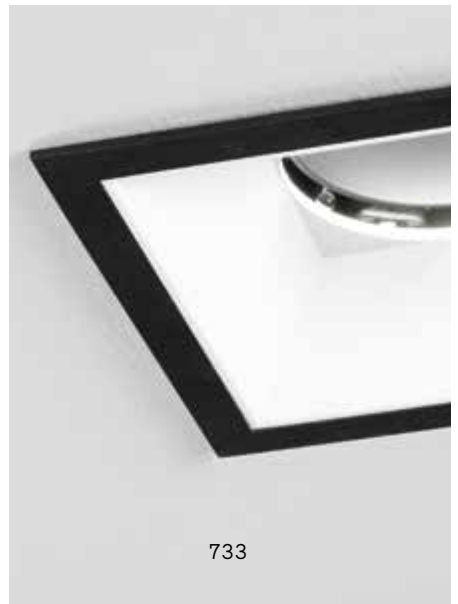

Bento

Sistema componibile di elementi ad incasso costituito da sorgente orientabili, riflettore e ghiera, con lenti e accessori schermanti in opzione; finitura bianca e nera; ghiera a incasso disponibile in forma singola rotonda o quadrata, oppure rettangolare in versione doppia o tripla per l'installazione di sorgenti multiple e indipendenti; anello anti-abbagliamento opzionale per arretramento della sorgente in modalità non orientabile; tre diversi angoli di emissione a scelta. Sorgente luminosa con tecnologia COB LED integrato per la massima efficienza, disponibile con una temperatura di colore di 3000 K; LED ad efficienza energetica ad elevata resa cromatica; CRI ≥ 90 ; binning iniziale ≤ 3 -Step MacAdam; classe isolamento II; durata utile LED 50.000 h L70B50. Disponibile in versione dimmerabile sia DALI che 1-10V. Per la sua dimensione compatta e grande versatilità è ottimale nelle installazioni di ambienti interni DOMESTICI, DIREZIONALI e RETAIL.

PRO

Prodotto ad alto contenuto tecnologico, elevata qualità dei materiali, destinato ad uso professionale.

UGR

Articolo con UGR <19.

Sorgente	LED COB
Potenza	9W / 13W
Driver incluso	On/Off
Driver disponibili	1-10V / DALI / Push
MacAdam	SDCM 3
CCT	3000 K
CRI	≥ 90
UGR	<19
Durata LED	50.000 h
Classe isolamento	II
IP	20
Materiale	Alluminio
Garanzia	5 anni





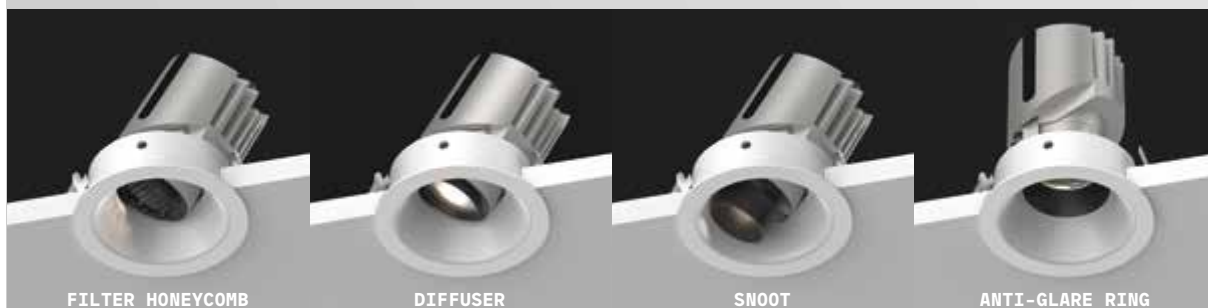

LENS



FILTER HONEYCOMB



DIFFUSER



SNOOT



ANTI-GLARE RING

Necessario	Angolo	Finitura	Codice	€
No	18°	Trasparen.	287942	4
	45°	Trasparen.	279626	4
No		Nero	279718	4
No		Nero	279725	3
No		Nero	279701	4
No		Bianco	288147	3
		Nero	279695	3

Bento - Source

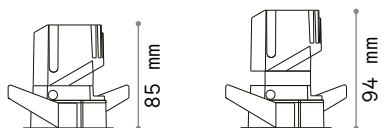

with anti-glare ring

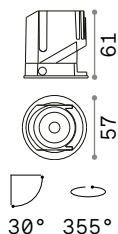

0,400 Kg/0,0003 m³

LED COB CITIZEN Necessario - Driver TRIDONIC ON/OFF incluso

Potenza	Angolo	Lumen	CCT	Finitura	Codice	€
9W	36°	730 lm	3000 K	Nero	279596	45

DIMMABLE DRIVER* Optional

	Potenza	Output	Misura (LxHxP)	Codice	€
1-10V	12 W	250 mA	122x25x40 mm	287843	58
DALI / Push	20 W	250 mA	120x29x51 mm	287850	87

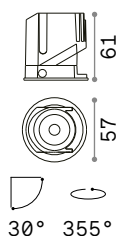

0,400 Kg/0,0003 m³

LED COB CITIZEN Necessario - Driver TRIDONIC ON/OFF incluso

Potenza	Angolo	Lumen	CCT	Finitura	Codice	€
13 W	36°	1000 lm	3000 K	Nero	279602	50

DIMMABLE DRIVER* Optional

	Potenza	Output	Misura (LxHxP)	Codice	€
1-10V / Push	20 W	350 mA	108x22x52 mm	287867	75
DALI / Push	20 W	350 mA	120x29x51 mm	287874	80



Light beam: ACCENT

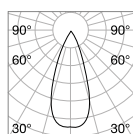

m	lx	øm
1	1312	0,71
2	328	1,40
3	146	2,10
4	82	2,80
5	52	3,50



CRI≥90 9W 36° 730lm 3000K

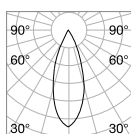

m	lx	øm
1	1846	0,65
2	461	1,30
3	205	1,90
4	115	2,60
5	74	3,20



CRI≥90 13W 36° 1000lm 3000K

* Gli alimentatori dimmerabili devono essere ordinati contestualmente al prodotto e verranno già inclusi all'interno degli apparecchi in sostituzione degli alimentatori on-off.
** Lente 36° inclusa.

Bento - Frame and Reflector

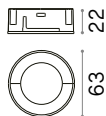

0,020 Kg/0,0001 m³

ROUND - REFLECTOR Necessario

Finitura	Codice	€
Bianco	279633	6
Nero	279640	6

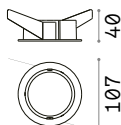

Ⓜ 68 mm

0,060 Kg/0,0001 m³

ROUND - FRAME SINGLE Necessario

Finitura	Codice	€
Bianco	287898	12
Nero	287881	12

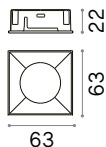

0,020 Kg/0,0001 m³

SQUARE - REFLECTOR Necessario

Finitura	Codice	€
Bianco	279671	8
Nero	279688	8

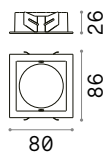

Ⓜ 68 x 68 mm

0,050 Kg/0,0002 m³

SQUARE - FRAME SINGLE Necessario

Finitura	Codice	€
Bianco	287911	14
Nero	287904	14

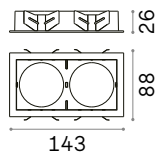

Ⓜ 134 x 71 mm

0,110 Kg/0,0004 m³

SQUARE - FRAME TWIN Necessario

Finitura	Codice	€
Bianco	287935	24
Nero	280233	24

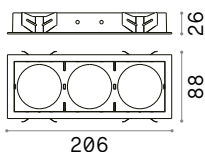

Ⓜ 197 x 71 mm

0,300 Kg/0,0006 m³

SQUARE - FRAME TRIPLE Necessario

Finitura	Codice	€
Bianco	287928	30
Nero	280240	30



Dynamic

Sistema componibile di elementi ad incasso in alluminio costituito da sorgente, riflettore e ghiera, con lenti e schermi in opzione; finitura bianca, nera; incasso possibile di forma rotonda o quadrata, tre diversi angoli di emissione a scelta. Sorgente luminosa con tecnologia COB LED integrato per la massima efficienza, disponibile con una temperatura di colore di 2700 K, 3000 K o 4000 K; LED ad efficienza energetica ad elevata resa cromatica; CRI ≥ 90 ; binning iniziale ≤ 3 -Step MacAdam; protezione frontale IP54 (a prodotto installato); classe isolamento II; durata utile LED 50.000 h L70B50. Disponibile in versione dimmerabile sia DALI che 1-10V. Per la sua dimensione compatta e grande versatilità è ottimale nelle installazioni di ambienti interni DOMESTICI, DIREZIONALI e RETAIL.

PRO

Prodotto ad alto contenuto tecnologico, elevata qualità dei materiali, destinato ad uso professionale.

UGR

Articolo con UGR <19.





IP54

Grado di protezione IP54.

Sorgente	LED COB
Potenza	9W / 10W / 15W
Driver incluso	On/Off
Driver disponibili	1-10V / DALI / Push
MacAdam	SDCM 3
CCT	2700 K / 3000 K / 4000 K
CRI	≥ 90
UGR	<19
Durata LED	50.000 h
Classe isolamento	II
IP	54
Materiale	Alluminio
Garanzia	5 anni





		Necessario	Angolo	Finitura	Codice	€
	LENS	No	20°	Trasparen.	211763	7
			55°	Trasparen.	211770	7
	FILTER HONEYCOMB	No		Nero	208671	7
	FILTER ELLIPTICAL	No		Trasparen.	208688	7
	GU10 ADAPTOR WITH LAMPHOLDER INCLUDED - IP20	No		Bianco	208640	16
				Nero	208657	16



Light beam: ACCENT

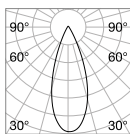

m	lx	Øm
1	1653	0,72
2	413	1,44
3	184	2,16
4	103	2,88
5	66	3,60



CRI≥90 9W 35° 870lm 3000K

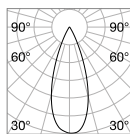

m	lx	Øm
1	1643	0,66
2	410	1,32
3	182	1,98
4	102	2,64
5	65	3,30



CRI≥90 10W 35° 1000lm 3000K

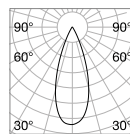

m	lx	Øm
1	2294	0,64
2	573	1,29
3	254	1,93
4	143	2,58
5	91	3,23



CRI≥90 15W 35° 1150lm 3000K

Dynamic - Source

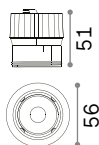

0,180 Kg/0,0030 m³

LED COB CITIZEN Necessario - Driver TRIDONIC ON/OFF incluso

Potenza	Angolo	Lumen	CCT	Finitura	Codice	€
9W	35°	840 lm	2700 K	Nero	252971	45
		870 lm	3000 K	Nero	252988	45
		1000 lm	4000 K	Nero	252995	45

DIMMABLE DRIVER* Optional

Potenza	Output	Misura (LxHxP)	Codice	€	
1-10V	12 W	200 mA	125x27x45 mm	253008	50
DALI/Push	9 W	200 mA	135x20x30 mm	253015	120

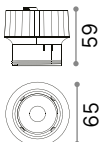

0,150 Kg/0,0030 m³

LED COB CITIZEN Necessario - Driver TRIDONIC ON/OFF incluso

Potenza	Angolo	Lumen	CCT	Finitura	Codice	€
10W	35°	970 lm	2700 K	Nero	208541	65
		1000 lm	3000 K	Nero	208558	65
		1100 lm	4000 K	Nero	208565	65

DIMMABLE DRIVER* Optional

Potenza	Output	Misura (LxHxP)	Codice	€	
1-10V	10 W	250 mA	135x20x30 mm	216317	40
DALI/Push	17 W	250 mA	130x30x43 mm	216027	110

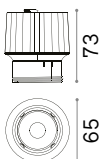

0,350 Kg/0,0030 m³

LED COB CITIZEN Necessario - Driver TRIDONIC ON/OFF incluso

Potenza	Angolo	Lumen	CCT	Finitura	Codice	€
15W	35°	1500 lm	2700 K	Nero	208572	90
		1150 lm	3000 K	Nero	208589	90
		1650 lm	4000 K	Nero	208596	90

DIMMABLE DRIVER* Optional

Potenza	Output	Misura (LxHxP)	Codice	€	
1-10V	20 W	350 mA	101x29x51 mm	216324	65
DALI/Push	17 W	350 mA	130x30x43 mm	216263	115

* Gli alimentatori dimmerabili devono essere ordinati contestualmente al prodotto e verranno già inclusi all'interno degli apparecchi in sostituzione degli alimentatori on-off. ** Lente 35° inclusa.

Dynamic Round

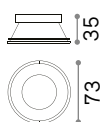
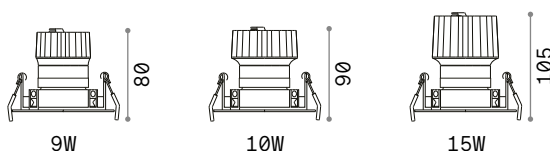

REFLECTOR Necessario

SIMMETRICO

Finitura	Codice	€
Bianco	211787	8
Nero	211794	8

0,020 Kg/0,0002 m³

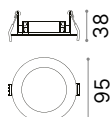

FRAME Necessario

Finitura	Codice	€
Bianco	208695	17
Nero	208701	17

① 80 mm

0,060 Kg/0,0004 m³



Dynamic Square

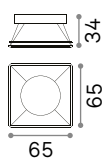
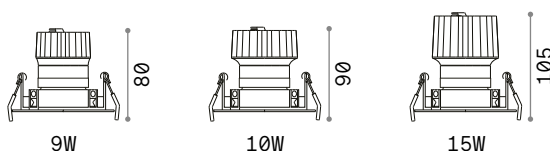

0,020 Kg/0,0002 m³

REFLECTOR Necessario

SIMMETRICO

Finitura	Codice	€
Bianco	211817	8
Nero	211824	8

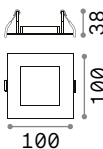

① 90 mm

0,050 Kg/0,0004 m³

FRAME Necessario

Finitura	Codice	€
Bianco	208725	19
Nero	208732	19



Game ^{new}

Faretto ad incasso in alluminio pressofuso con ghiera rotonda o quadrata, adatto per installazione su soffitti in cartongesso o a pannelli. Finitura cromata, bianca opaca RAL 9001, nera opaca RAL 9011, oro opaca RAL 1032. Disponibile in versione con cornice esterna (TRIM), a scomparsa senza cornice per cartongesso (TRIMLESS), oppure con cornice e protezione frontale migliorata (IP65). Tecnologia LED COB; disponibile in temperatura di colore 2700 K, 3000 K o 4000 K; protezione IP20; classe isolamento II; durata utile LED 50.000 h L70B50. Disponibile anche in versione dimmerabile 1-10V, DALI e PUSH.

UGR Articolo con UGR <19.

Sorgente	LED COB
Potenza	11W / 20W
Driver incluso	On/Off
Driver disponibili	1-10V/Push / DALI/Push
CCT	2700 K / 3000 K / 4000 K
CRI	≥80 / ≥90
UGR	<19
Durata LED	50.000 h
Classe isolamento	II
IP	20 / 65
Materiale	Alluminio
Garanzia	5 anni





Game Trim Round

LED COB CREE Driver ON/OFF incluso - CRI ≥80

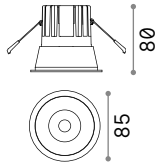

⌀ 75 mm
0,280 Kg/0,0011 m³

Potenza	Angolo	Lumen	CCT	Finitura	Codice	€
11W	36°	1000 lm	2700 K	Bianco +	285429	47
		1100 lm	3000 K	Argento +	192284	47
				Bianco +	192291	47
				Nero +	192277	47
				Oro +	192307	47
		1250 lm	4000 K	Bianco +	267975	47

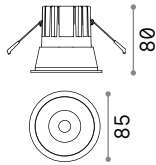

⌀ 75 mm
0,280 Kg/0,0011 m³

Potenza	Angolo	Lumen	CCT	Finitura	Codice	€
11W	36°	1000 lm	2700 K	Nero +	285412	47
		1100 lm	3000 K	Argento +	192321	47
				Bianco +	192338	47
				Nero +	192314	47
				Oro +	192345	47
		1250 lm	4000 K	Nero +	267968	47

IP65

Potenza	Angolo	Lumen	CCT	Finitura	Codice	€
11W	36°	1100 lm	3000 K	Bianco +	313191	75 <small>new</small>
				Nero +	327754	75 <small>new</small>

DIMMABLE DRIVER* Optional

	Potenza	Output	Misura (L x H x P)	Codice	€
1-10V/Push	20 W	250 mA	111 x 22 x 52 mm	217253	60
DALI/Push	12 W	250 mA	132 x 20 x 30 mm	202396	60

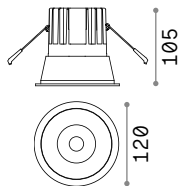

⌀ 110 mm
0,660 Kg/0,0033 m³

LED COB BRIDGELUX Driver ON/OFF incluso - CRI ≥90

Potenza	Angolo	Lumen	CCT	Finitura	Codice	€
20W	24°	2350 lm	3000 K	Bianco +	273174	90
				Nero +	273167	90



Light beam: ACCENT



Light beam: SPOT

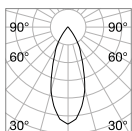

m	lx	cm
1	1545	0,69
2	386	1,38
3	171	2,07
4	96	2,77
5	61	3,46

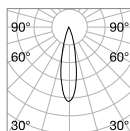

m	lx	cm
1	8645	0,41
2	2161	0,83
3	961	1,20
4	540	1,70
5	346	2,10



CRI≥90 11W 36° 1100lm 3000K

CRI≥90 20W 24° 2350lm 3000K

* Gli alimentatori dimmerabili devono essere ordinati contestualmente al prodotto e verranno già inclusi all'interno degli apparecchi in sostituzione degli alimentatori on-off.



Game Trim Square

LED COB CREE Driver ON/OFF incluso - CRI ≥80

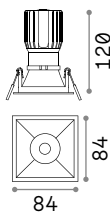

75 x 75 mm
0,270 Kg/0,0011 m³

Potenza	Angolo	Lumen	CCT	Finitura	Codice	€
11W	36°	1000 lm	2700 K	Bianco +	285443	47
		1100 lm	3000 K	Bianco +	192376	47
				Nero +	192352	47

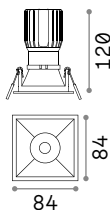

75 x 75 mm
0,270 Kg/0,0011 m³

Potenza	Angolo	Lumen	CCT	Finitura	Codice	€
11W	36°	1000 lm	2700 K	Nero +	285436	47
		1100 lm	3000 K	Bianco +	192406	47
				Nero +	192383	47

IP65

Potenza	Angolo	Lumen	CCT	Finitura	Codice	€
11W	36°	1100 lm	3000 K	Bianco +	313207	75 <i>new</i>
				Nero +	327761	75 <i>new</i>

DIMMABLE DRIVER* Optional

	Potenza	Output	Misura (L x H x P)	Codice	€
1-10V/Push	20 W	250 mA	111 x 22 x 52 mm	217253	60
DALI/Push	12 W	250 mA	132 x 20 x 30 mm	202396	60



Light beam: ACCENT

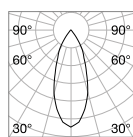

m	lx	Øm
1	1545	0,69
2	386	1,38
3	171	2,07
4	96	2,77
5	61	3,46



CRI≥90 11W 36° 1100lm 3000K

* Gli alimentatori dimmerabili devono essere ordinati contestualmente al prodotto e verranno già inclusi all'interno degli apparecchi in sostituzione degli alimentatori on-off.



Game Trimless

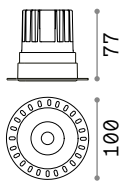

⌀ 75 mm

0,300 Kg/0,0011 m³

LED COB CREE Driver ON/OFF incluso - CRI ≥80

Potenza	Angolo	Lumen	CCT	Finitura	Codice	€
11W	36°	1100 lm	3000 K	Bianco	319667	50 <i>new</i>
				Nero	319650	50 <i>new</i>

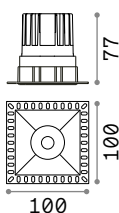

75 x 75 mm

0,300 Kg/0,0011 m³

LED COB CREE Driver ON/OFF incluso - CRI ≥80

Potenza	Angolo	Lumen	CCT	Finitura	Codice	€
11W	36°	1100 lm	3000 K	Bianco	319681	50 <i>new</i>
				Nero	319674	50 <i>new</i>

DIMMABLE DRIVER* Optional

	Potenza	Output	Misura (LxHxP)	Codice	€
1-10V/Push	20 W	250 mA	111x22x52 mm	217253	60
DALI/Push	12 W	250 mA	132x20x30 mm	202396	60



Light beam: ACCENT

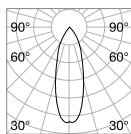

m	lx	Øm
1	1609	0,60
2	402	1,20
3	179	1,80
4	101	2,40
5	64	3,00



CRI≥80 11W 36° 1100lm 3000K

* Gli alimentatori dimmerabili devono essere ordinati contestualmente al prodotto e verranno già inclusi all'interno degli apparecchi in sostituzione degli alimentatori on-off.

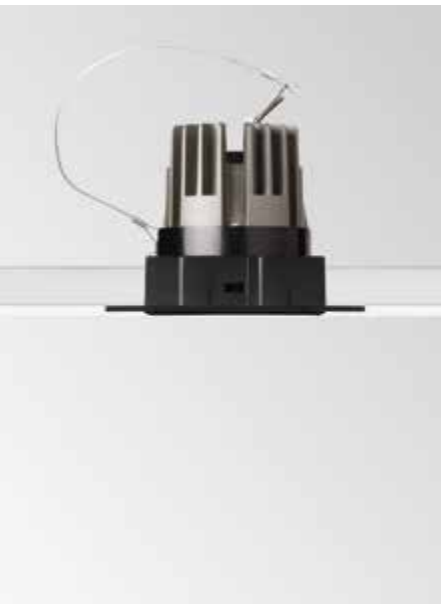

One

Sorgente	LED SMD	Durata LED	30.000 h
Potenza	2W / 3W	Classe isolamento	II
Driver incluso	On/Off	IP	20
Driver disponibili	No	Materiale	Alluminio
CCT	3000 K	Garanzia	5 anni
CRI	≥90		

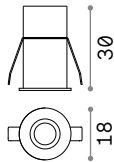

⌀ 17 mm

0,050 Kg/0,0001 m³

LED SMD Driver ON/OFF incluso*

Potenza	Angolo	Lumen	CCT	Finitura	Codice	€
2W	23°	130 lm	3000 K	Bianco	274768	31

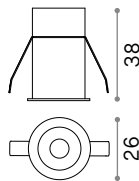

⌀ 25 mm

0,070 Kg/0,0001 m³

LED SMD Driver ON/OFF incluso*

Potenza	Angolo	Lumen	CCT	Finitura	Codice	€
2W	30°	130 lm	3000 K	Bianco	274775	37

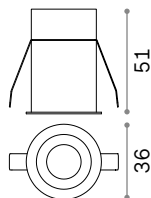

⌀ 35 mm

0,100 Kg/0,0003 m³

LED SMD Driver ON/OFF incluso*

Potenza	Angolo	Lumen	CCT	Finitura	Codice	€
3W	23°	270 lm	3000 K	Bianco	274782	41



Light beam: SPOT

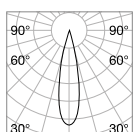

m	lx	Øm
1	372	0,40
2	93	0,81
3	41	1,20
4	23	1,60
5	15	2,00



CRI≥90 2W 23° 130lm 3000K



Light beam: SPOT

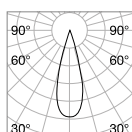

m	lx	Øm
1	307	0,53
2	77	1,10
3	34	1,60
4	19	2,10
5	12	2,70



CRI≥90 2W 30° 130lm 3000K



Light beam: SPOT

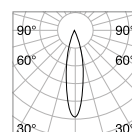

m	lx	Øm
1	866	0,40
2	216	0,80
3	96	1,20
4	54	1,60
5	35	2,00



CRI≥90 3W 23° 270lm 3000K

* Misure L 38,3 x H 16,5 x P 19,3 mm



Virus

Sorgente	LED SMD	Durata LED	50.000 h
Potenza	3W	Classe isolamento	II
Driver incluso	On/Off	IP	20
Driver disponibili	No	Materiale	Alluminio
CCT	3000 K	Garanzia	5 anni
CRI	≥90		

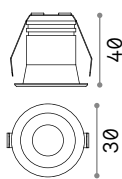

⌀ 30 mm
0,070 Kg/0,0003 m³

LED SMD OSRAM Driver ON/OFF incluso

Potenza	Angolo	Lumen	CCT	Finitura	Codice	€
3W	20°	210 lm	3000 K	Bianco	+ 244808	32
				Oro	+ 244822	32
				Nero	+ 244846	32
				Oro	+ 244853	32



Light beam: SPOT

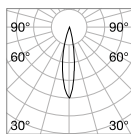

m	lx	Øm
1	1374	0,30
2	344	0,60
3	153	0,91
4	86	1,20
5	55	1,50



CRI≥90 3W 20° 210lm 3000K



244808



244822



244846



244853



Quark new

Sorgente	LED COB / SMD	Durata LED	30.000 h
Potenza	2W / 3W / 5W / 8W	Classe isolamento	II
Driver incluso	On/Off	IP	20
Driver disponibili	No	Materiale	Alluminio
CCT	3000 K	Garanzia	5 anni
CRI	≥90		

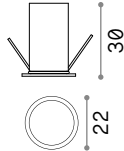

⌀ 18 mm

0,020 Kg/0,0004 m³

LED SMD BRIDGELUX Driver ON/OFF incluso

Potenza	Angolo	Lumen	CCT	Finitura	Codice	€
2W	30°	180 lm	3000 K	Bianco	327471	35 <small>new</small>
				Nero	305844	35 <small>new</small>

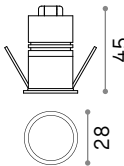

⌀ 25 mm

0,070 Kg/0,0004 m³

LED SMD BRIDGELUX Driver ON/OFF incluso

Potenza	Angolo	Lumen	CCT	Finitura	Codice	€
3W	25°	250 lm	3000 K	Bianco	327488	40 <small>new</small>
				Nero	305851	40 <small>new</small>

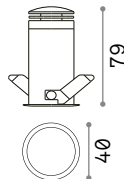

⌀ 35 mm

0,140 Kg/0,0004 m³

LED SMD BRIDGELUX Driver ON/OFF incluso

Potenza	Angolo	Lumen	CCT	Finitura	Codice	€
5W	30°	320 lm	3000 K	Bianco	307756	50 <small>new</small>
				Nero	327495	50 <small>new</small>

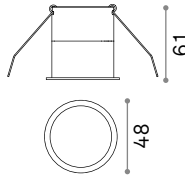

⌀ 45 mm

0,170 Kg/0,0005 m³

LED COB CITIZEN Driver ON/OFF incluso

Potenza	Angolo	Lumen	CCT	Finitura	Codice	€
8W	30°	720 lm	3000 K	Bianco	258478	57
				Nero	258461	57



Light beam: ACCENT

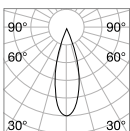

m	lx	Øm
1	1446	0,54
2	362	1,10
3	161	1,60
4	90	2,20
5	56	2,70



CRI≥80 8W 30° 720lm 3000K



761

Off

Incasso fisso in alluminio pressofuso con ghiera rotonda in tre dimensioni, adatto per installazione su soffitti in cartongesso. Finitura nera opaca RAL 9005 e bianca opaca RAL 9016, LED integrati raffreddati passivamente; tecnologia COB (Chip on Board) per la massima efficienza; UGR < 19; binning iniziale ≤ 3-Step MacAdam; disponibile in temperatura di colore 3000 K e 4000 K; CRI ≥ 90; protezione frontale IP54 (a prodotto installato); classe isolamento II; in opzione dimmerabile 1-10V, DALI e Push; durata utile LED 50.000 h L80B50. Adatto per UFFICI e ambienti DIREZIONALI e in generale dove vi sia la presenza di videotermini e la necessità di garantire un controllo dell'abbagliamento elevato. L'elevata resa cromatica lo rende ideale anche per gli spazi espositivi e la valorizzazione della merce in showroom e aree vendita nel settore RETAIL.

PRO Prodotto ad alto contenuto tecnologico, elevata qualità dei materiali, destinato ad uso professionale.

UGR Articolo con UGR <19.

IP54 Grado di protezione IP54.

Sorgente	LED COB
Potenza	15W / 28W / 42W
Driver incluso	On/Off
Driver disponibili	1-10V / DALI / Push
MacAdam	SDCM 3
CCT	3000 K / 4000 K
CRI	≥90
UGR	<19
Durata LED	50.000 h
Classe isolamento	II
IP	54
Materiale	Alluminio
Garanzia	5 anni





Off

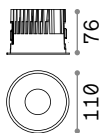

⌀ 100 mm

0,460 Kg/0,0021 m³

LED COB CITIZEN Driver TRIDONIC ON/OFF incluso

Potenza	Angolo	Lumen	CCT	Finitura	Codice	€
15 W	50°	1350 lm	3000 K	Bianco	266497	86
				Nero	266558	86
		1450 lm	4000 K	Bianco	266503	86
				Nero	266565	86

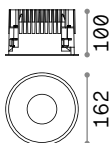

⌀ 150 mm

0,990 Kg/0,0045 m³

LED COB CITIZEN Driver TRIDONIC ON/OFF incluso

Potenza	Angolo	Lumen	CCT	Finitura	Codice	€
28 W	60°	2900 lm	3000 K	Bianco	266510	128
				Nero	266572	128
		3150 lm	4000 K	Bianco	266527	128
				Nero	266589	128

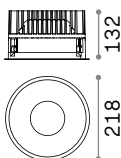

⌀ 205 mm

1,850 Kg/0,0094 m³

LED COB CITIZEN Driver TRIDONIC ON/OFF incluso

Potenza	Angolo	Lumen	CCT	Finitura	Codice	€
42 W	60°	4150 lm	3000 K	Bianco	266534	180
				Nero	266596	180
		4500 lm	4000 K	Bianco	266541	180
				Nero	266602	180

DIMMABLE DRIVER* Optional

Modello	Controllo	Potenza	Output	Misura (L x H x P)	Codice	€
Off 15 W	1-10V/Push	20 W	350 mA	105 x 20 x 50 mm	266657	70
	DALI	20 W	350 mA	120 x 29 x 51 mm	266701	70
Off 28 W	1-10V/Push	22 W	700 mA	100 x 20 x 65 mm	266671	95
	DALI	32 W	700 mA	108 x 30 x 44 mm	266725	95
Off 42 W	1-10V	42 W	1050 mA	120 x 20 x 75 mm	266688	115
	DALI/Push	45 W	1050 mA	150 x 30 x 43 mm	266732	110



Light beam: WIDE

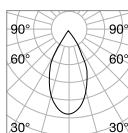

m	lx	øm
1	1688	0,93
2	422	1,90
3	188	2,80
4	105	3,70
5	68	4,60

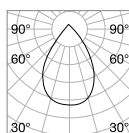

m	lx	øm
1	2457	1,30
2	614	2,50
3	273	3,80
4	154	5,10
5	98	6,40

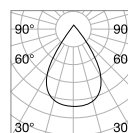

m	lx	øm
1	3496	1,20
2	874	2,40
3	388	3,60
4	218	4,80
5	140	6,00



CRI≥90 15W 50° 1350lm 3000K

CRI≥90 28W 60° 2900lm 3000K

CRI≥90 42W 60° 4150lm 3000K

* Gli alimentatori dimmerabili devono essere ordinati contestualmente al prodotto e verranno già inclusi all'interno degli apparecchi in sostituzione degli alimentatori on-off.



765

Deep

Sorgente	LED SMD	Durata LED	50.000 h
Potenza	10W/20W/30W	Classe isolamento	II
Driver incluso	On/Off	IP	20
Driver disponibili	1-10V/DALI/ Push	Materiale	Alluminio
CCT	3000 K/4000 K	Garanzia	5 anni
CRI	≥80		



① 90 mm

0,160 Kg/0,0014 m³

LED SMD Driver ON/OFF incluso

Potenza	Angolo	Lumen	CCT	Finitura	Codice	€
10 W	70°	1350 lm	3000 K	Bianco	249018	28
		1450 lm	4000 K	Bianco	249025	28

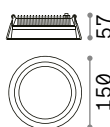

① 145 mm

0,360 Kg/0,0037 m³

LED SMD Driver ON/OFF incluso

Potenza	Angolo	Lumen	CCT	Finitura	Codice	€
20 W	77°	2750 lm	3000 K	Bianco	249032	62
		2950 lm	4000 K	Bianco	249049	62

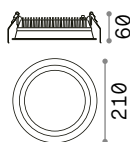

① 200 mm

0,650 Kg/0,0053 m³

LED SMD Driver ON/OFF incluso

Potenza	Angolo	Lumen	CCT	Finitura	Codice	€
30 W	77°	4150 lm	3000 K	Bianco	248783	84
		4350 lm	4000 K	Bianco	248790	84

DIMMABLE DRIVER* Optional

Modello	Controllo	Potenza	Output	Misura (LxHxP)	Codice	€
Deep 10 W	1-10V	10 W	300 mA	135 x 20 x 30 mm	248950	57
	DALI/Push	12 W	300 mA	135 x 20 x 30 mm	248967	57
Deep 20 W	1-10V/Push	35 W	500 mA	124 x 22 x 79 mm	248974	98
	DALI/Push	35 W	500 mA	167 x 32 x 41 mm	248981	98
Deep 30 W	1-10V/Push	54 W	750 mA	167 x 32 x 41 mm	248998	105
	DALI/Push	45 W	700 mA	167 x 30 x 39 mm	249001	105



Light beam: WIDE

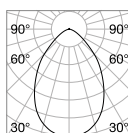

m	lx	øm
1	625	1,43
2	156	2,86
3	69	4,30
4	39	5,73
5	25	7,16

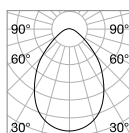

m	lx	øm
1	1056	1,60
2	264	3,20
3	117	4,81
4	66	6,41
5	42	8,01

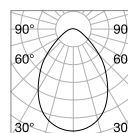

m	lx	øm
1	1644	1,60
2	411	3,20
3	183	4,81
4	103	6,41
5	66	8,01



CRI≥80 10W 70° 1350lm 3000K

CRI≥80 20W 77° 2750lm 3000K

CRI≥80 30W 77° 4150lm 3000K

* Gli alimentatori dimmerabili devono essere ordinati contestualmente al prodotto e verranno già inclusi all'interno degli apparecchi in sostituzione degli alimentatori on-off.



Basic

Faretto a incasso in alluminio pressofuso con ghiera rotonda, adatto per installazione su soffitti in cartongesso. Finitura bianca opaca; tecnologia COB Chip on Board e SMD. Disponibile in temperatura di colore 3000 K e 4000 K e con tre diverse ottiche; CRI ≥ 80 ; protezione frontale IP44 (a prodotto installato); classe isolamento II; durata utile LED 30.000 h L70B50.

IP44 Grado di protezione IP44.

Sorgente	LED COB / SMD
Potenza	10W / 15W / 20W / 30W
Driver incluso	On/Off
Driver disponibili	1-10V / DALI / Push
MacAdam	SDCM ≤ 3
CCT	3000 K / 4000 K
CRI	≥ 80
Durata LED	30.000 h
Classe isolamento	II
IP	44
Materiale	Alluminio
Garanzia	5 anni





Basic Accent

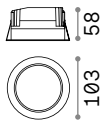

① 90 mm
0,400 Kg/0,0017 m³

LED COB PHILIPS Driver PHILIPS ON/OFF incluso

Potenza	Angolo	Lumen	CCT	Finitura	Codice	€
10 W	45°	1050 lm	3000 K	Bianco	193458	68
		1200 lm	4000 K	Bianco	193359	68

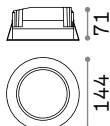

① 125 mm
0,660 Kg/0,0027 m³

LED COB PHILIPS Driver PHILIPS ON/OFF incluso

Potenza	Angolo	Lumen	CCT	Finitura	Codice	€
15 W	52°	1500 lm	3000 K	Bianco	193465	85
		1550 lm	4000 K	Bianco	193366	85
20 W		1950 lm	3000 K	Bianco	193472	90
		2050 lm	4000 K	Bianco	193373	90

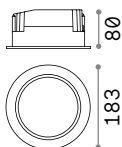

① 160 mm
1,250 Kg/0,0056 m³

LED COB PHILIPS Driver PHILIPS ON/OFF incluso

Potenza	Angolo	Lumen	CCT	Finitura	Codice	€
30 W	46°	2500 lm	3000 K	Bianco	193489	145
		2550 lm	4000 K	Bianco	193380	145

DIMMABLE DRIVER* Optional

Modello	Controllo	Potenza	Output	Misura (LxHxP)	Codice	€
Basic 10 W	1-10V	12 W	300 mA	150 x 29 x 43 mm	218823	40
	DALI/Push	10 W	300 mA	130 x 30 x 43 mm	220772	125
Basic 15 W	1-10V	15 W	450 mA	150 x 29 x 43 mm	218830	45
	DALI/Push	17 W	450 mA	130 x 30 x 43 mm	220796	134
Basic 20 W	DALI/Push	25 W	700 mA	130 x 30 x 43 mm	220789	146
Basic 30 W	1-10V	31 W	900 mA	150 x 29 x 43 mm	218854	50
	DALI/Push	45 W	900 mA	150 x 30 x 43 mm	220802	158



Light beam: ACCENT

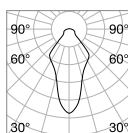

m	lx	øm
1	533	0,81
2	133	1,62
3	59	2,44
4	33	3,25
5	21	4,07

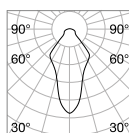

m	lx	øm
1	719	0,98
2	179	1,96
3	79	2,95
4	44	3,93
5	28	4,92

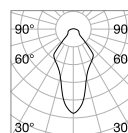

m	lx	øm
1	1250	0,92
2	312	1,84
3	138	2,76
4	78	3,69
5	50	4,61



CRI≥80 10W 45° 1050lm 3000K

CRI≥80 15W 52° 1500lm 3000K

CRI≥80 30W 46° 2500lm 3000K

* Gli alimentatori dimmerabili devono essere ordinati contestualmente al prodotto e verranno già inclusi all'interno degli apparecchi in sostituzione degli alimentatori on-off.



Basic Wide

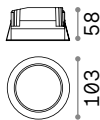

① 90 mm
0,370 Kg/0,0017 m³

LED SMD SAMSUNG Driver PHILIPS ON/OFF incluso

Potenza	Angolo	Lumen	CCT	Finitura	Codice	€
10 W	85°	1150 lm	3000 K	Bianco	193519	65
		1200 lm	4000 K	Bianco	193403	65

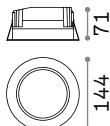

① 125 mm
0,630 Kg/0,0027 m³

LED SMD SAMSUNG Driver PHILIPS ON/OFF incluso

Potenza	Angolo	Lumen	CCT	Finitura	Codice	€
15 W	87°	1750 lm	3000 K	Bianco	193526	80
		1800 lm	4000 K	Bianco	193410	80
20 W		2400 lm	3000 K	Bianco	193533	85
		2500 lm	4000 K	Bianco	193427	85

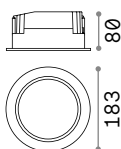

① 160 mm
1,130 Kg/0,0056 m³

LED SMD SAMSUNG Driver PHILIPS ON/OFF incluso

Potenza	Angolo	Lumen	CCT	Finitura	Codice	€
30 W	90°	3050 lm	3000 K	Bianco	193540	140
		3150 lm	4000 K	Bianco	193434	140

DIMMABLE DRIVER* Optional

Modello	Controllo	Potenza	Output	Misura (LxHxP)	Codice	€
Basic 10 W	1-10V	12 W	300 mA	150 x 29 x 43 mm	218823	40
	DALI/Push	10 W	300 mA	130 x 30 x 43 mm	220772	125
Basic 15 W	1-10V	15 W	450 mA	150 x 29 x 43 mm	218830	45
	DALI/Push	17 W	450 mA	130 x 30 x 43 mm	220796	134
Basic 20 W	DALI/Push	25 W	700 mA	130 x 30 x 43 mm	220789	146
Basic 30 W	1-10V	31 W	900 mA	150 x 29 x 43 mm	218854	50
	DALI/Push	45 W	900 mA	150 x 30 x 43 mm	220802	158



Light beam: **WIDE**

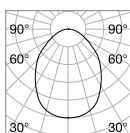

m	lx	Øm
1	188	1,84
2	47	3,69
3	20	5,54
4	11	7,39
5	7	9,24

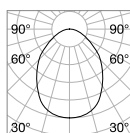

m	lx	Øm
1	318	1,72
2	79	3,44
3	35	5,17
4	19	6,89
5	12	8,61

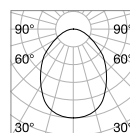

m	lx	Øm
1	591	1,84
2	147	3,69
3	65	5,53
4	36	7,38
5	23	9,23



CRI≥80 10W 85° 1150lm 3000K

CRI≥80 15W 87° 1750lm 3000K

CRI≥80 30W 90° 3050lm 3000K

* Gli alimentatori dimmerabili devono essere ordinati contestualmente al prodotto e verranno già inclusi all'interno degli apparecchi in sostituzione degli alimentatori on-off.



Basic IP65 new

IP65 CRI ≥90 50.000 h ALLUMINIO

IP65 Grado di protezione IP65.

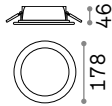

① 155 mm

0,300 Kg/0,0036 m³

LED SMD OSRAM Driver ON/OFF incluso

Potenza	Angolo	Lumen	CCT	Finitura	Codice	€
15 W	105°	1550 lm	3000 K	Bianco	312118	65 <small>new</small>

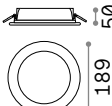

① 160 mm

0,450 Kg/0,0041 m³

LED SMD OSRAM Driver ON/OFF incluso

Potenza	Angolo	Lumen	CCT	Finitura	Codice	€
20 W	105°	2250 lm	3000 K	Bianco	312125	75 <small>new</small>

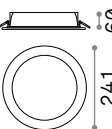

① 205 mm

0,650 Kg/0,0068 m³

LED SMD OSRAM Driver ON/OFF incluso

Potenza	Angolo	Lumen	CCT	Finitura	Codice	€
28 W	105°	3200 lm	3000 K	Bianco	312132	110 <small>new</small>

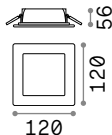

① 105 x 105 mm

0,300 Kg/0,0020 m³

LED SMD OSRAM Driver ON/OFF incluso

Potenza	Angolo	Lumen	CCT	Finitura	Codice	€
15 W	100°	1550 lm	3000 K	Bianco	312156	60 <small>new</small>

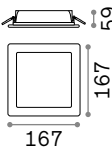

① 145 x 145 mm

0,500 Kg/0,0037 m³

LED SMD OSRAM Driver ON/OFF incluso

Potenza	Angolo	Lumen	CCT	Finitura	Codice	€
18 W	100°	1850 lm	3000 K	Bianco	312163	95 <small>new</small>

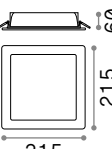

① 185 x 185 mm

0,700 Kg/0,0055 m³

LED SMD OSRAM Driver ON/OFF incluso

Potenza	Angolo	Lumen	CCT	Finitura	Codice	€
25 W	100°	2750 lm	3000 K	Bianco	312170	115 <small>new</small>



Light beam: **WIDE**



Groove

IP20 CRI ≥80 30.000 h ALLUMINIO

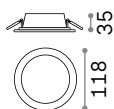

① 100 mm

0,220 Kg/0,0012 m³

LED SMD AND DRIVER Incluso

Potenza	Angolo	Lumen	CCT	Finitura	Codice	€
10 W	110°	1250 lm	3000 K	Bianco	123974	29
		1350 lm	4000 K	Bianco	147666	29

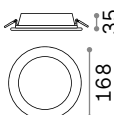

① 150 mm

0,410 Kg/0,0023 m³

LED SMD AND DRIVER Incluso

Potenza	Angolo	Lumen	CCT	Finitura	Codice	€
20 W	110°	2600 lm	3000 K	Bianco	123998	35
		2700 lm	4000 K	Bianco	147673	35

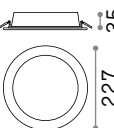

① 205 mm

0,660 Kg/0,0036 m³

LED SMD AND DRIVER Incluso

Potenza	Angolo	Lumen	CCT	Finitura	Codice	€
30 W	110°	3800 lm	3000 K	Bianco	124018	46
		4050 lm	4000 K	Bianco	147680	46

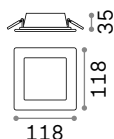

① 100 x 100 mm

0,270 Kg/0,0012 m³

LED SMD AND DRIVER Incluso

Potenza	Angolo	Lumen	CCT	Finitura	Codice	€
10 W	110°	1200 lm	3000 K	Bianco	123981	30

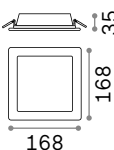

① 150 x 150 mm

0,540 Kg/0,0023 m³

LED SMD AND DRIVER Incluso

Potenza	Angolo	Lumen	CCT	Finitura	Codice	€
20 W	110°	2450 lm	3000 K	Bianco	124001	36

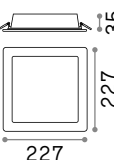

① 205 x 205 mm

0,850 Kg/0,0036 m³

LED SMD AND DRIVER Incluso

Potenza	Angolo	Lumen	CCT	Finitura	Codice	€
30 W	110°	3900 lm	3000 K	Bianco	124025	49



Light beam: WIDE

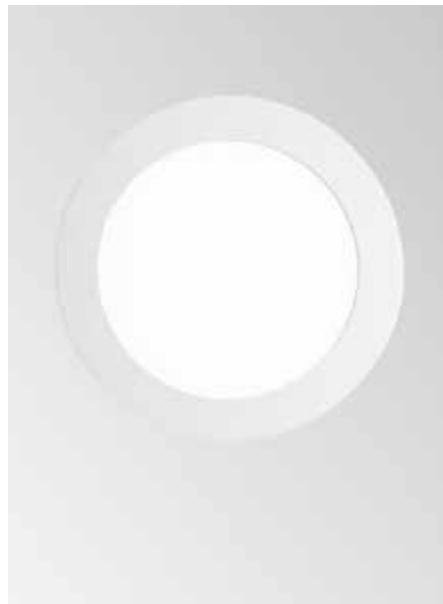

Aura

Sorgente	LED SMD	Durata LED	30.000 h
Potenza	20W	Classe isolamento	II
Driver incluso	On/Off	IP	20
Driver disponibili	No	Materiale	Alluminio
CCT	3000 K/4000 K	Garanzia	5 anni
CRI	≥80		

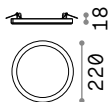

LED SMD Driver ON/OFF incluso

⌀ min 65-max 205 mm
0,350 Kg/0,0018 m³

Potenza	Angolo	Lumen	CCT	Finitura	Codice	€
20 W	115°	2050 lm	3000 K	Bianco	290799	35
				Nero	290775	35
		2100 lm	4000 K	Bianco	306346	35
				Nero	306360	35

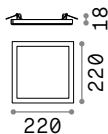

LED SMD Driver ON/OFF incluso

⌀ min 65-max 205 mm
0,400 Kg/0,0018 m³

Potenza	Angolo	Lumen	CCT	Finitura	Codice	€
20 W	115°	2200 lm	3000 K	Bianco	290836	40
				Nero	290812	40
		2250 lm	4000 K	Bianco	306384	40
				Nero	306407	40



Light beam: WIDE

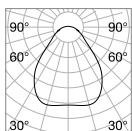

m	lx	Øm
1	1470	1,79
2	367	3,59
3	163	5,38
4	92	7,18
5	59	8,97



CRI≥80 20W 115° 2050lm 3000K



P. 309



Play

Sorgente	LED COB	Durata LED	30.000 h
Potenza	7W	Classe isolamento	II
Driver incluso	On/Off	IP	20
Driver disponibili	No	Materiale	Alluminio
CCT	3000 K	Garanzia	5 anni
CRI	≥90		

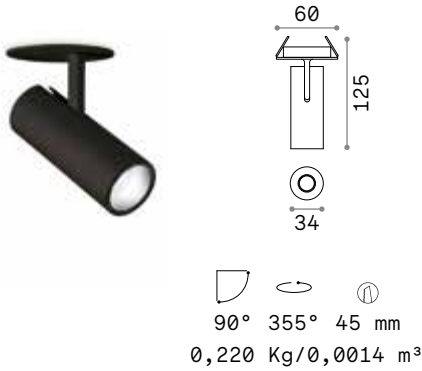

LED COB Driver ON/OFF incluso

Potenza	Angolo	Lumen	CCT	Finitura	Codice	€
7W	17°	520 lm	3000 K	Bianco	258270	60
				Nero	268088	60



Light beam: SPOT

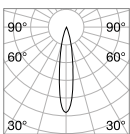

m	lx	Øm
1	2632	0,31
2	658	0,63
3	292	0,94
4	164	1,30
5	105	1,60



CRI≥90 7W 17° 520lm 3000K





Nova

Sorgente	LED COB	Durata LED	50.000 h
Potenza	12W / 30W	Classe isolamento	II
Driver incluso	On/Off	IP	20
Driver disponibili	1-10V / DALI / Push	Materiale	Alluminio
CCT	3000 K / 4000 K	Garanzia	5 anni
CRI	≥90		

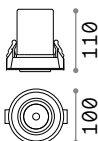

90° 360° 90 mm
 0,550 Kg/0,0016 m³

LED COB PHILIPS Driver ON/OFF incluso - UGR <19

Potenza	Angolo	Lumen	CCT	Finitura	Codice	€
12 W	38°	1000 lm	3000 K	Bianco	248165	75
				Nero	248189	75
		1100 lm	4000 K	Bianco	267937	75
				Nero	267920	75

DIMMABLE DRIVER* Optional

	Potenza	Output	Misura (LxHxP)	Codice	€
1-10V / Push	15 W	300 mA	111 x 22 x 52 mm	243993	60
DALI / Push	12 W	300 mA	132 x 20 x 30 mm	243986	60

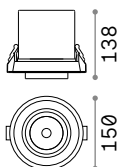

90° 360° 140 mm
 1,160 Kg/0,0039 m³

LED COB PHILIPS Driver ON/OFF incluso - UGR <22

Potenza	Angolo	Lumen	CCT	Finitura	Codice	€
30 W	38°	3000 lm	3000 K	Bianco	248172	125
				Nero	248196	125
		3250 lm	4000 K	Bianco	267951	125
				Nero	267944	125

DIMMABLE DRIVER* Optional

	Potenza	Output	Misura (LxHxP)	Codice	€
1-10V / Push	36 W	750 mA	167 x 32 x 41 mm	248370	110
DALI / Push	36 W	700 mA	135 x 24 x 72 mm	248592	110



LENS

Modello	Necessario	Angolo	Codice	€
Nova 12W	No	15°	244013	6
Nova 30W	No	15°	248608	12



Light beam: ACCENT

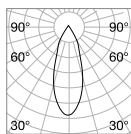

m	lx	cm
1	1768	0,66
2	442	1,32
3	196	1,97
4	111	2,63
5	71	3,29

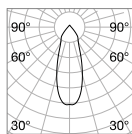

m	lx	cm
1	4671	0,64
2	1168	1,28
3	519	1,93
4	292	2,57
5	187	3,21



CRI≥90 12W 38° 1000lm 3000K

CRI≥90 30W 38° 3000lm 3000K

* Gli alimentatori dimmerabili devono essere ordinati contestualmente al prodotto e verranno già inclusi all'interno degli apparecchi in sostituzione degli alimentatori on-off.



Led Panel

Sorgente	LED SMD	UGR	<19
Potenza	40W	Durata LED	25.000 h
Driver incluso	On/Off	Classe isolamento	II
Driver disponibili	1-10V / DALI / Push	IP	20
CCT	3000 K / 4000 K	Materiale	Alluminio
CRI	≥80 / ≥90	Garanzia	5 anni

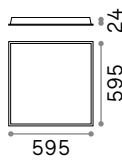

2,200 Kg/0,0144 m³
Q.tà d'acquisto 2 pezzi

LED SMD Driver ON/OFF incluso

CRI ≥80

Potenza	Angolo	Lumen	CCT	Finitura	Codice	€
40 W	81°	4150 lm	3000 K	Bianco	249711	45
		4450 lm	4000 K	Bianco	249728	45

CRI ≥90

Potenza	Angolo	Lumen	CCT	Finitura	Codice	€
40 W	81°	3550 lm	3000 K	Bianco	246390	45
		3800 lm	4000 K	Bianco	244181	45

DIMMABLE DRIVER* Optional

	Potenza	Output	Misura (L x H x P)	Codice	€
1-10V	42 W	1000 mA	125 x 26 x 83 mm	247854	37
DALI/Push	45 W	1000 mA	106 x 28 x 69 mm	247847	67



KIT PENDANT

KIT SURFACE

RECESSED FRAME**

	Necessario	N° Cavi	Lunghezza cavi	Codice	€
	No	4	1000 mm	244198	6
	No			244204	6
	No			267692	20



Light beam: WIDE

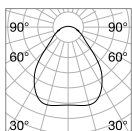

m	lx	Øm
1	1470	1,79
2	367	3,59
3	163	5,38
4	92	7,18
5	59	8,97



CRI≥80 40W 81° 4150lm 3000K

* Gli alimentatori dimmerabili devono essere ordinati contestualmente al prodotto e verranno già inclusi all'interno degli apparecchi in sostituzione degli alimentatori on-off.

**RECESSED FRAME 607 x 607 mm

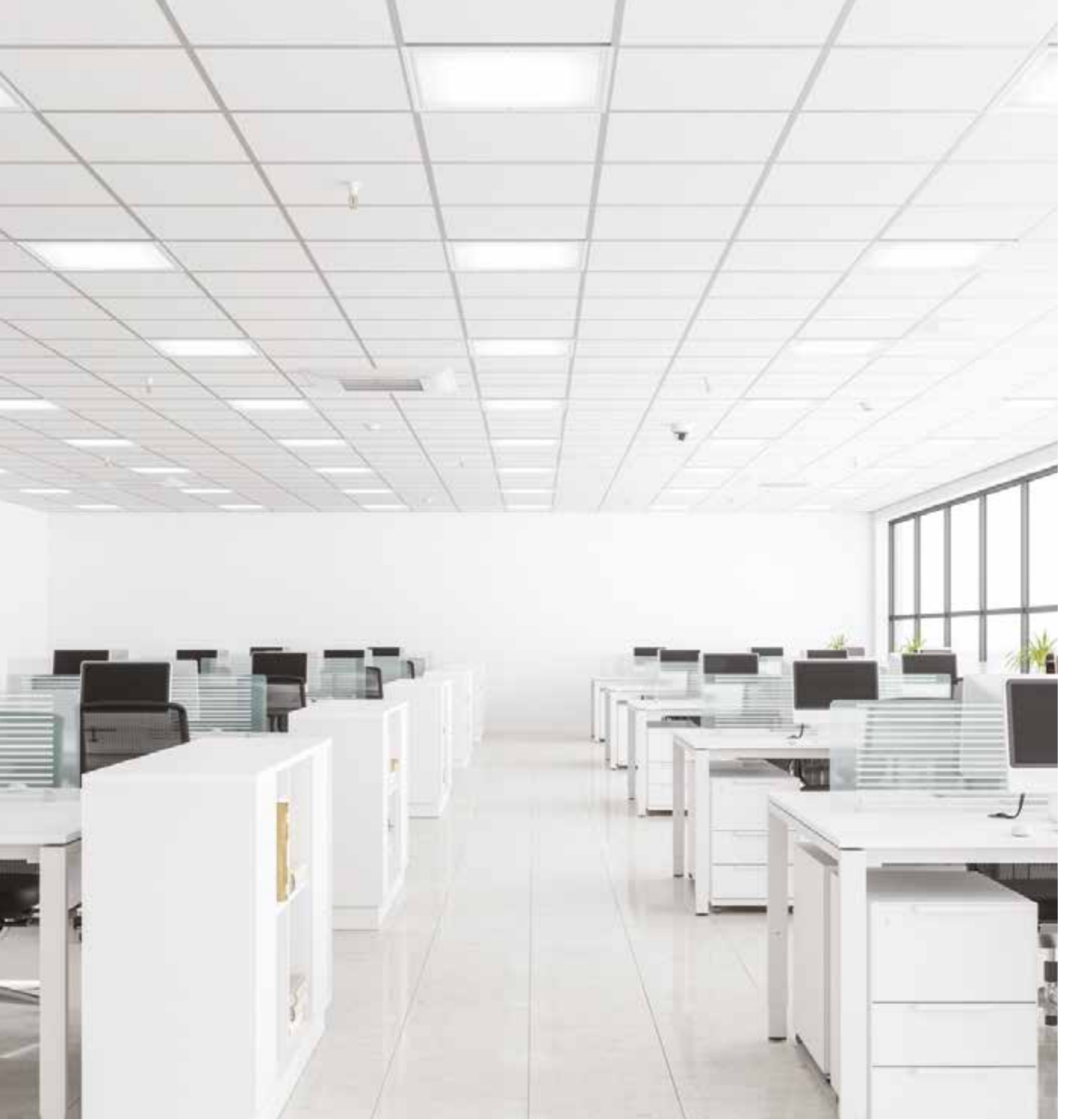

Lika **new**

Proiettore a incasso LED rettangolare in alluminio pressofuso verniciato nero o bianco, con riflettore in policarbonato nero lucido. Disponibile nelle versioni TRIM e SLIM con cornice per installazione su pannelli o soffitti, oppure TRIMLESS con bordo arretrato a scomparsa per installazione su soffitti in cartongesso. Moduli disponibili con due, cinque oppure dieci sorgenti luminose. Appositamente disegnato per evitare abbagliamenti ($UGR < 16$), trova la sua migliore collocazione all'interno di UFFICI e spazi COMMERCIALI oppure in ambienti residenziali minimalisti. Sorgente luminosa a LED integrati; disponibile in temperatura di colore 3000 K e 4000 K; elevata resa cromatica $CRI \geq 90$; protezione IP20, classe isolamento II; durata utile LED 50.000 h L70B50. Disponibile anche in versione dimmerabile 1-10V, DALI e PUSH.

UGR Articolo con $UGR < 16$.

Sorgente	LED COB / SMD
Potenza	6W / 12W / 20W
Driver incluso	On/Off
Driver disponibili	DALI / Push
CCT	3000 K / 4000 K
CRI	≥ 90
UGR	< 16
Durata LED	50.000 h
Classe isolamento	II
IP	20
Materiale	Alluminio
Garanzia	5 anni





Lika Trim

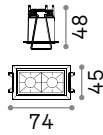

68 x 37 mm
0,130 Kg/0,0005 m³

LED COB OSRAM Driver ON/OFF incluso

Potenza	Angolo	Lumen	CCT	Finitura	Codice	€
6 W	29°	480 lm	3000 K	Nero	+ ■ 206196	45
		520 lm	4000 K	Nero	+ ■ 267869	45

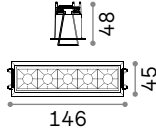

140 x 37 mm
0,320 Kg/0,0013 m³

LED COB OSRAM Driver ON/OFF incluso

Potenza	Angolo	Lumen	CCT	Finitura	Codice	€
12 W	29°	1200 lm	3000 K	Nero	+ ■ 206219	65
		1250 lm	4000 K	Nero	+ ■ 267876	65

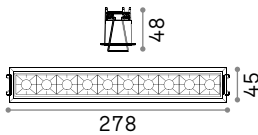

273 x 37 mm
0,480 Kg/0,0016 m³

LED COB OSRAM Driver ON/OFF incluso

Potenza	Angolo	Lumen	CCT	Finitura	Codice	€
20 W	29°	1750 lm	3000 K	Nero	+ ■ 206233	110
		1850 lm	4000 K	Nero	+ ■ 267883	110

DIMMABLE DRIVER* Optional

Modello	Controllo	Potenza	Output	Misura (LxHxP)	Codice	€
Lika 6 W	DALI	10 W	700 mA	132 x 20 x 30 mm	267982	56
Lika 12 W	DALI	12 W	700 mA	135 x 24 x 72 mm	267999	56
Lika 20 W	DALI/Push	25 W	600 mA	135 x 24 x 72 mm	268002	104



Light beam: ACCENT

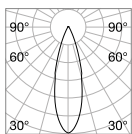

m	lx	Øm
1	2091	0,58
2	523	1,16
3	232	1,74
4	131	2,32
5	70	2,90



CRI≥90 12W 29° 1200lm 3000K

* Gli alimentatori dimmerabili devono essere ordinati contestualmente al prodotto e verranno già inclusi all'interno degli apparecchi in sostituzione degli alimentatori on-off.

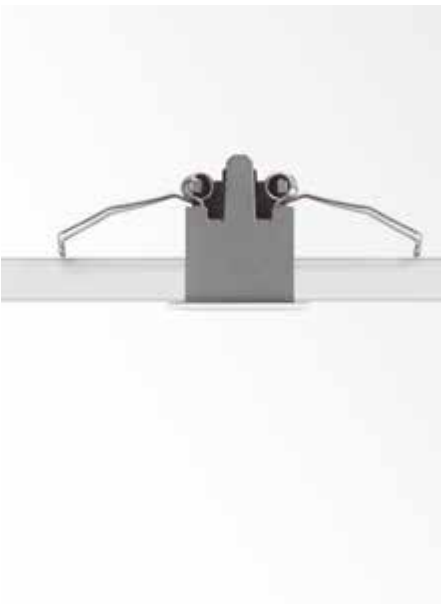

Lika Trimless

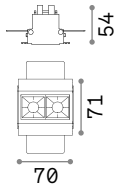

75 x 70 mm
0,220 Kg/0,0006 m³

LED COB OSRAM Driver ON/OFF incluso

Potenza	Angolo	Lumen	CCT	Finitura	Codice	€
6 W	29°	480 lm	3000 K	Nero	206202	60
		520 lm	4000 K	Nero	267890	60

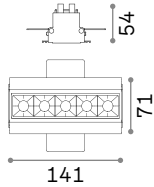

145 x 70 mm
0,390 Kg/0,0013 m³

LED COB OSRAM Driver ON/OFF incluso

Potenza	Angolo	Lumen	CCT	Finitura	Codice	€
12 W	29°	1200 lm	3000 K	Nero	206226	95
		1250 lm	4000 K	Nero	267906	95

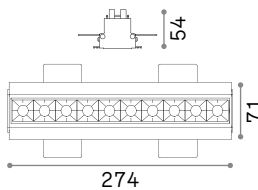

278 x 70 mm
0,720 Kg/0,0023 m³

LED COB OSRAM Driver ON/OFF incluso

Potenza	Angolo	Lumen	CCT	Finitura	Codice	€
20 W	29°	1750 lm	3000 K	Nero	206240	151
		1850 lm	4000 K	Nero	267913	151

DIMMABLE DRIVER* Optional

Modello	Controllo	Potenza	Output	Misura (LxHxP)	Codice	€
Lika 6 W	DALI	10 W	700 mA	132x20x30 mm	267982	56
Lika 12 W	DALI	12 W	700 mA	135x24x72 mm	267999	56
Lika 20 W	DALI/Push	25 W	600 mA	135x24x72 mm	268002	104



Light beam: ACCENT

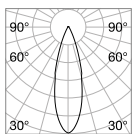

m	lx	Øm
1	2786	0,58
2	696	1,16
3	309	1,74
4	174	2,32
5	111	2,90



CRI≥90 12W 29° 1200lm 3000K

* Gli alimentatori dimmerabili devono essere ordinati contestualmente al prodotto e verranno già inclusi all'interno degli apparecchi in sostituzione degli alimentatori on-off.



Lika Slim

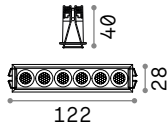

LED SMD Driver ON/OFF incluso

Potenza	Angolo	Lumen	CCT	Finitura	Codice	€
10 W	32°	1000 lm	3000 K	Bianco	327501	65 <small>new</small>
				Nero	305813	65 <small>new</small>

117 x 23 mm
0,180 Kg/0,0013 m³

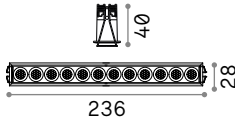

LED SMD Driver ON/OFF incluso

Potenza	Angolo	Lumen	CCT	Finitura	Codice	€
19 W	32°	2000 lm	3000 K	Bianco	327518	110 <small>new</small>
				Nero	305837	110 <small>new</small>

231 x 23 mm
0,300 Kg/0,0022 m³



Light beam: ACCENT

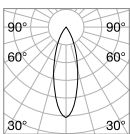

m	lx	Øm
1	1958	0,55
2	489	1,10
3	218	1,70
4	122	2,20
5	78	2,80



CRI≥90 12W 29° 1200lm 3000K



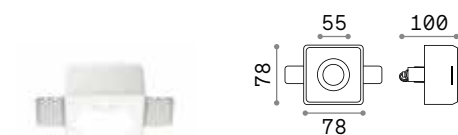

83 x 83 mm



103 mm

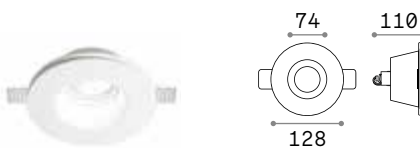

133 mm

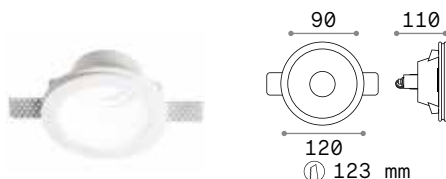

123 mm

GU10 Non inclusa - Lampadina consigliata 108292

Potenza	Peso	Volume	Finitura	Codice	€
max 35W	0,360 Kg	0,0016 m ³	Bianco	230580	15

Potenza	Peso	Volume	Finitura	Codice	€
max 35W	0,240 Kg	0,0018 m ³	Bianco	150307	15

Potenza	Peso	Volume	Finitura	Codice	€
max 35W	0,450 Kg	0,0032 m ³	Bianco	150130	15

Potenza	Peso	Volume	Finitura	Codice	€
max 50W	0,420 Kg	0,0036 m ³	Bianco	139012	15

GU10 Non inclusa - Lampadina consigliata 108292

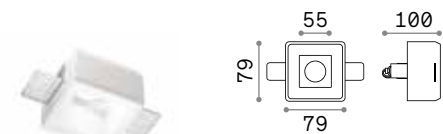

83 x 83 mm



103 x 103 mm

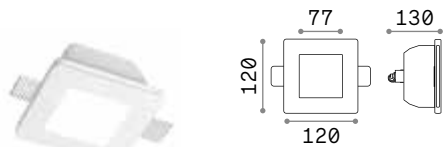

123 x 123 mm

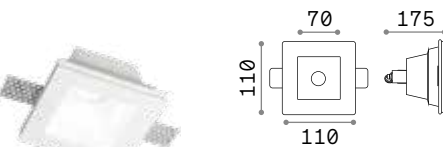

124 x 124 mm

Potenza	Peso	Volume	Finitura	Codice	€
max 35W	0,330 Kg	0,0016 m ³	Bianco	229997	15

Potenza	Peso	Volume	Finitura	Codice	€
max 35W	0,330 Kg	0,0019 m ³	Bianco	150291	15

Potenza	Peso	Volume	Finitura	Codice	€
max 35W	0,600 Kg	0,0037 m ³	Bianco	150116	15

Diffusore in vetro

Potenza	Peso	Volume	Finitura	Codice	€
max 50W	0,430 Kg	0,0023 m ³	Bianco	139029	15

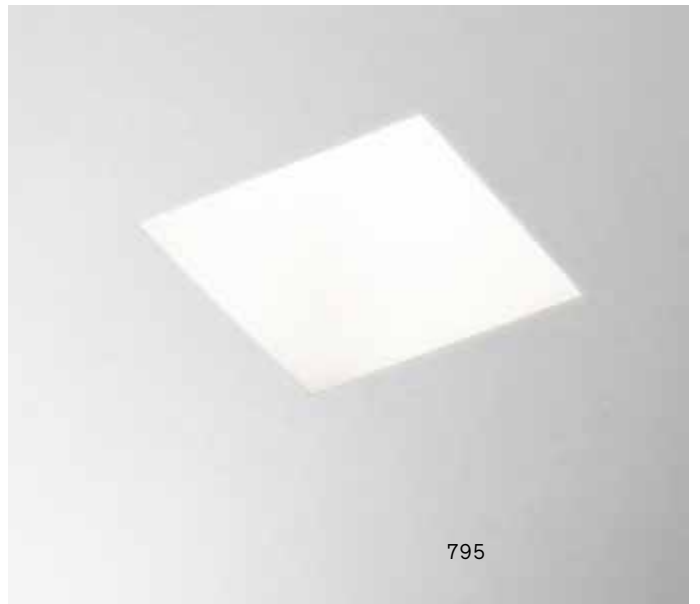

Zephyr

 IP20
  GESSO

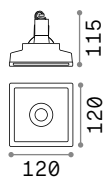



 123 x 123 mm
 0,880 Kg/0,0032 m³

GU10 Non inclusa - Lampadina consigliata 108292

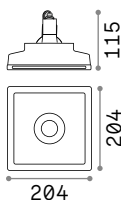
Potenza	Finitura	Codice	€
max 35W	Bianco	150284	15



 20° 110°
  207 x 207 mm
 1,350 Kg/0,0075 m³

GU10 Non inclusa - Lampadina consigliata 108292

Potenza	Finitura	Codice	€
max 35W	Bianco	155722	50



Chill **new**

☐ IP20 CRI ≥80 25.000 h ALLUMINIO

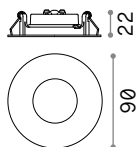

⌀ 68 mm

0,050 Kg/0,0003 m³

LED SMD Driver ON/OFF incluso

Potenza	Angolo	Lumen	CCT	Finitura	Codice	€
7 W	100°	680 lm	3000 K	Bianco	☐ 316772	8 new
				Nero	■ 327723	8 new
7 W	100°	700 lm	4000 K	Bianco	☐ 327747	8 new
				Nero	■ 327730	8 new



Light beam: **WIDE**

Jazz

IP20 ZINCO

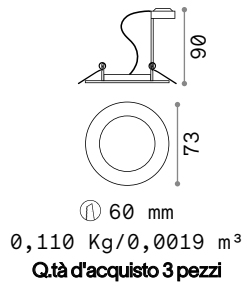

GU10 Non inclusa - Lampadina consigliata 108292

Potenza	Finitura	Codice	€
max 50W	Bianco	083117	10
	Brunito	083124	10
	Cromo	083070	10
	Nero	243818	10
	Nickel	083087	10

Swing

IP20 ZINCO

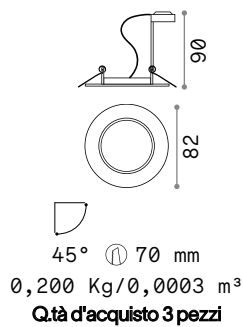

GU10 Non inclusa - Lampadina consigliata 108292

Potenza	Finitura	Codice	€
max 50W	Bianco	083179	12
	Brunito	083186	12
	Cromo	083131	12
	Nero	243825	12
	Nickel	083148	12

Lounge

IP20 ZINCO

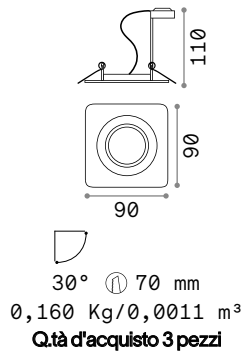

GU10 Non inclusa - Lampadina consigliata 108292

Potenza	Finitura	Codice	€
max 50W	Bianco	138978	17

Funky

IP20 FERRO

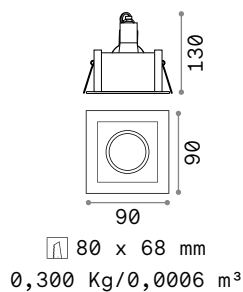

GU10 Non inclusa - Lampadina consigliata 108292

Potenza	Finitura	Codice	€
max 50W	Alluminio	083223	18
	Bianco	083230	18
	Brunito	083247	18
	Cromo	083193	18
	Nero	243849	18



Room-65

IP65 CRI ≥80 50.000 h ALLUMINIO

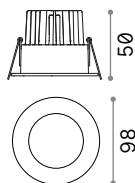

① 68 mm

0,220 Kg/0,0011 m³

LED COB Driver ON/OFF incluso

Potenza	Angolo	Lumen	CCT	Finitura	Codice	€
8 W	38°	800 lm	3000 K	Bianco	252025	77
				Nero	252032	77

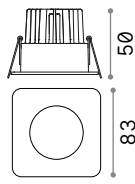

① 68 mm

0,240 Kg/0,0011 m³

LED COB Driver ON/OFF incluso

Potenza	Angolo	Lumen	CCT	Finitura	Codice	€
8 W	38°	800 lm	3000 K	Bianco	252049	77
				Nero	252056	77



Light beam: ACCENT



Blues

 IP20 VETRO

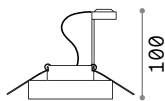

Ⓢ 60 mm

0,281 Kg/0,0031 m³

Q.tà d'acquisto 3 pezzi

GU10 Non inclusa - Lampadina consigliata 108292

Potenza	Finitura	Codice	€
max 50W	Trasparente	083254	24
	Bianco	113999	24
	Fumè	113982	24

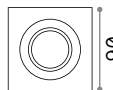
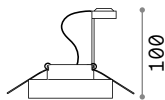

Ⓢ 60 mm

0,340 Kg/0,0012 m³



Q.tà d'acquisto 3 pezzi

GU10 Non inclusa - Lampadina consigliata 108292

Potenza	Finitura	Codice	€
max 50W	Trasparente	114019	24



Soul

  IP20 CRISTALLO

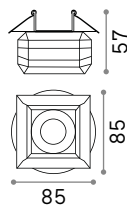

① 55 mm

0,340 Kg/0,0009 m³

G9 Non inclusa - Lampadina consigliata 305486

Potenza	Finitura	Codice	€
max 40W	Trasparente	107691	20

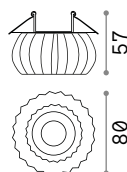

① 55 mm

0,400 Kg/0,0008 m³

G9 Non inclusa - Lampadina consigliata 305486

Potenza	Finitura	Codice	€
max 40W	Trasparente	107707	20



Polka

□ △ IP20

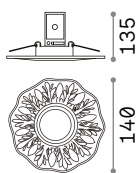

① 65 mm

0,250 Kg/0,0022 m³

GU10 Non inclusa - Lampadina consigliata 108292

Potenza	Materiale	Finitura		Codice	€
max 50W	Gesso	Bianco		115597	16
	Alluminio	Ottone		115610	16
	Alluminio	Brunito		115580	16



115597



115610



115580



Walky

IP20
 CRI ≥ 90
 50.000 h GESSO

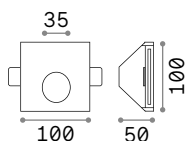

100 x 100mm

0,580 Kg/0,0009 m³

LED SMD AND DRIVER Incluso

Potenza	Lumen	CCT	Finitura	Codice	€
1W	55 lm	3000 K	Bianco	<input type="checkbox"/> 249834	63

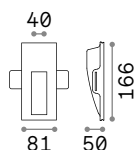

81 x 166 mm

0,580 Kg/0,0012 m³

LED SMD AND DRIVER Incluso

Potenza	Lumen	CCT	Finitura	Codice	€
1W	55 lm	3000 K	Bianco	<input type="checkbox"/> 249827	63



Light beam: **ASYMMETRICAL**



Esterni

Sospensioni e soffitto

Indice alfabetico

Bubble	814
Clio	808
Fiesta	815
Gun	811
Luna	807
Mib	814
Sole	806
Sunglasses	812
Techo	810
Urano	813
Xeno	812

Indice icone

<small>new</small>					
	Sole 806	Luna 807			
<small>new</small>		<small>new</small>		<small>new</small>	
	Clio 808		Clio 808		Clio 808
<small>new</small>		<small>new</small>		<small>new</small>	
	Clio 808		Clio 808		Clio 808
<small>new</small>					
	Techo 810	Gun 811	Sunglasses 812		
					
	Xeno 812	Urano 813	Bubble 814		
					
	Mib 814	Fiesta 815			



Sole new

Diffusore in materiale plastico opale. Base sospensione in alluminio. Cavo elettrico in PVC.

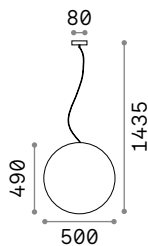

2,970 Kg / 0,1327 m³
E27 max 1x60W

€ 180

136011 Bianco



151991 € 2,00

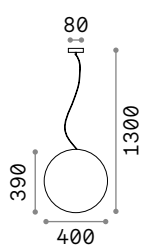

1,690 Kg / 0,0776 m³
E27 max 1x60W

€ 110

136004 Bianco

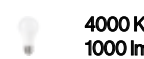

151991 € 2,00

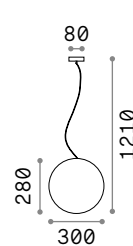

1,360 Kg / 0,0338 m³
E27 max 1x60W

€ 95

135991 Bianco

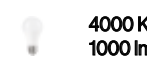

151991 € 2,00

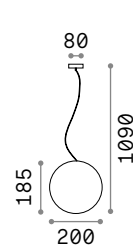

1,300 Kg / 0,0111 m³
E27 max 1x60W

€ 90

318837 Bianco new



151960 € 2,00



P. 873



Luna

Montatura in alluminio pressofuso e tornito rifinito con vernici a polveri. Diffusore in materiale plastico opale.

LED Lampadine LED G9 3W 4000 K incluse nel modello **213200**. Cod. **209036**

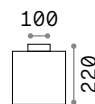

1,470 Kg / 0,0120 m³
E27 max 1x42W

€ 115

213194 Bianco



0,400 Kg / 0,0021 m³
G9 max 1x5W

€ 100

213200 Bianco

4000 K
1000 lm

151991 € 2,00

4000 K
530 lm

307879 € 6,00



P. 874

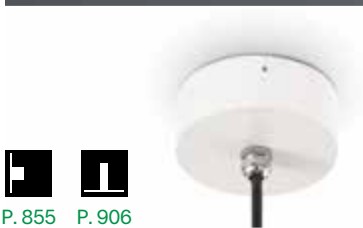

P. 855 P. 906

Clio new

Articolo componibile con montatura in alluminio estruso e tornito, rifinito con vernici a polveri di colore antracite, bianco, grigio, nero e coffee. Diffusore in materiale plastico bianco opaco.

116716



145068



145020



144252



144238



136073



144245



326801

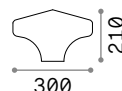
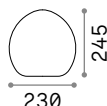
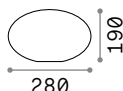
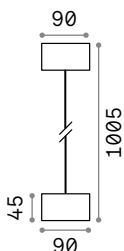

IP44

IP44

0,200 Kg / 0,0014 m³
E27 max 1x42W

0,580 Kg / 0,0019 m³
E27 max 1x42W

0,540 Kg / 0,0171 m³

0,520 Kg / 0,0144 m³

0,610 Kg / 0,0231 m³

€ 56

€ 73

€ 35

€ 35

€ 35

148847 Bianco
148854 Grigio
148861 Antracite
148878 Nero
326795 Coffee new

144252 Bianco
144238 Grigio
136073 Antracite
144245 Nero
326801 Coffee new

145068 Bianco

116716 Bianco

145020 Bianco

4000 K
600 lm

4000 K
600 lm

151960 € 2,00

151960 € 2,00



Techo new

Corpo luce in alluminio pressofuso verniciato a polveri. Diffusore in vetro temperato trasparente smerigliato. Disponibile nelle finiture antracite, bianco, grigio, coffee o nero.



251561



326894



251554



251578



251592

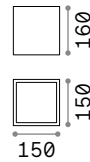

1,700 Kg / 0,0049 m³
GU10 max 1x20W

€ 115

251523 ■ Bianco
326887 ■ Grigio
251516 ■ Antracite
251530 ■ Nero
251547 ■ Coffee

 4000 K
820 lm

253398 € 15,00

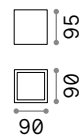

0,600 Kg / 0,0012 m³
GU10 max 1x20W

€ 64

251561 ■ Bianco
326894 ■ Grigio new
251554 ■ Antracite
251578 ■ Nero
251592 ■ Coffee

 4000 K
430 lm

253497 € 3,00



Gun

Corpo luce in alluminio con finitura naturale spazzolata o in vernice con varie finiture. Diffusore in vetro pirex trasparente.



122663 092324 163642 236865 122687 163666



0,490 Kg / 0,0030 m³
GU10 max 1x28W

€ 54

- 122663 Bianco
- 092324 Alluminio
- 163642 Grigio
- 236865 Antracite
- 122687 Nero
- 163666 Coffee

4000 K
430 lm

253497 € 3,00



P. 836

Sunglasses

Corpo luce in alluminio verniciato a polveri di colore antracite o bianco. Diffusori inclinabili con schermi in vetro trasparente.

LED Sorgente luminosa LED 4000 K, 30.000 h di durata.

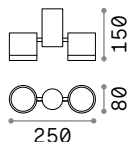

■ □ IP44

1,040 Kg / 0,0040 m³
LED 14,5W / 1450 lm

€ 130

161853 ■ Bianco
161846 ■ Antracite



161853

161846

Xeno

Corpo luce in alluminio rifinito con vernice opaca a polveri. Diffusori orientabili con vetro temperato trasparente. Disponibile nelle finiture bianco, grigio o nero.

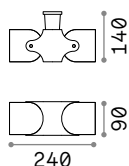

■ ⊕ IP44

0,830 Kg / 0,0044 m³
GU10 max 2 x 28W

€ 72

129495 ■ Bianco
129518 ■ Grigio
129501 ■ Nero

4000 K
430 lm



253497 € 3,00 P. 826



129495

129518

129501



Urano

Corpo luce in alluminio tornito verniciato a polveri con finitura opaca antracite o bianca. Diffusore in materiale acrilico trasparente e satinato.



168050



168135

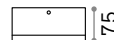

1,200 Kg / 0,0029 m³
GX53 max 1x15W

€ 95

168050 ■ Bianco
168135 ■ Antracite

4000 K
1000 lm

154008 € 5,50

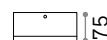

0,630 Kg / 0,0016 m³
GX53 max 1x15W

€ 70

168036 ■ Bianco
168111 ■ Antracite

4000 K
1000 lm

154008 € 5,50

Bubble

Montatura in alluminio pressofuso e tornito rifinito con vernici a polveri. Diffusore in materiale plastico bianco opaco.

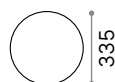

1,730 Kg / 0,0249 m³

E27 max 1x 60W

€ 125

135250 Bianco

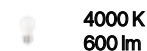

151960

€ 2,00

P. 854



Mib

Base in alluminio verniciato a polveri di colore bianco. Diffusore in materiale plastico opale. Sorgente luminosa a led integrati.

LED Sorgente luminosa LED 3000/4000 K, 35.000 h di durata.

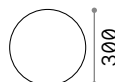

1,620 Kg / 0,0086 m³

LED 19W / 2000/2100 lm

€ 150

269115 Bianco 3000K

202945 Bianco 4000K

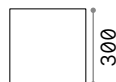

1,820 Kg / 0,0086 m³

LED 19W / 2100/2200 lm

€ 150

269122 Bianco 3000K

202921 Bianco 4000K





Fiesta

Cavo con portalampane e occhielli di ancoraggio in materiale plastico nero. Fornito con spina per esterni.

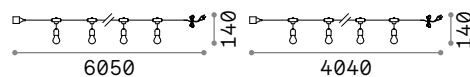

1,530 Kg / 0,0068 m³
E27 max 10 x 15W

€ 100

246796 ■ Nero

3000 K
340 lm

101286 € 2,60



0,600 Kg / 0,0049 m³
E27 max 5 x 15W

€ 65

159836 ■ Nero

3000 K
340 lm

101286 € 2,60



Esterni

Lampade da parete



Indice alfabetico

Andromeda	847	Rubik	842
Apollo	835	Snif Round	832
Argo	845	Snif Square	833
Atom	843	Style	828
Base	840	Swipe	827
Bubble	854	Terra	824
Cima	856	Tetris-1	844
Clio	855	Tetris-2	845
Cometa	852	Tronco	830
Dafne	857	Twin	846
Dedra	859	Up	844
Down	858	Xeno	826
Elio	822		
Etere	831		
Febe	858		
Felix	849		
Gas	825		
Giove	848		
Gun	836		
Iko	841		
Keope	834		
Linea	838		
Litio	823		
Medea	853		
Omega Round	820		
Omega Square	821		
Polar	853		
Punto	839		
Rex-1	850		
Rex-2	851		
Rex-3	851		



Atom

Pag 843



Omega R. 820

new



Style 828

new



Linea 838











































Tetris-2 845



Rex-3 851

Esterni

Indice icone

				 new		 new
Omega S. 821	Elio 822	Litio 823	Terra 824	Gas 825	Xeno 826	Swipe 827
 new	 new					
Tronco 830	Etere 831	Snif Round 832	Snif Square 833	Keope 834	Apollo 835	Gun 836
 new			 new	 new	 new	 new
Punto 839	Base 840	Iko 841	Rubik 842	Atom 843	Up 844	Tetris-1 844
 new	 new		 new		 new	
Argo 845	Twin 846	Andromeda 847	Giove 848	Felix 849	Rex-1 850	Rex-2 851
				 new	 new	 new
Cometa 852	Polar 853	Medea 853	Bubble 854	Clio 855	Clio 855	Clio 855
					 new	 new
		Cima 856	Dafne 857	Down 858	Febe 858	Dedra 859



Omega Round

Corpo luce in alluminio verniciato a polveri. Diffusore inclinabile con schermo in vetro. Disponibile nelle finiture antracite, bianco, coffee o nero.

LED Sorgente luminosa LED 3000/4000 K, 25.000 h di durata.



285474



285450



285504



285498

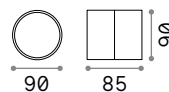

0,500 Kg / 0,0012 m³
LED 7W / 610/650 lm

€ 87

285474	Bianco	3000K
285481	Bianco	4000K
285450	Antracite	3000K
285467	Antracite	4000K
285504	Nero	4000K
285498	Coffee	4000K



Omega Square

Corpo luce in alluminio verniciato a polveri. Diffusore inclinabile con schermo in vetro. Disponibile nelle finiture antracite, bianco o nero.

LED Sorgente luminosa LED 4000 K, 25.000 h di durata.



285528



285511



285535

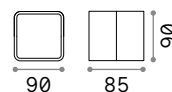

0,600 Kg / 0,0012 m³
LED 7W / 650 lm

€ 87

285528 ■ Bianco
285511 ■ Antracite
285535 ■ Nero



Elio

Corpo luce e diffusore in resina ad alte prestazioni: inattaccabile dalla corrosione sia di agenti atmosferici che di fertilizzanti chimici, colori stabilizzati da trattamento U.V., resistente a sbalzi termici da -60° C a + 90° C. Diffusore direzionabile.



096483

096476



Lampadine LED GU10 3,5W incluse.
CCT regolabile: 2700 K, 4000 K.

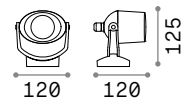

0,500 Kg / 0,0027 m³
GU10 max 1x6W

€ 82

096483 ■ Bianco
096476 ■ Nero

4000 K
430 lm
253497 € 3,00



P. 918



Litio

Corpo luce e diffusore in resina ad alte prestazioni: inattaccabile dalla corrosione sia di agenti atmosferici che di fertilizzanti chimici, colori stabilizzati da trattamento U.V., resistente a sbalzi termici da -60°C a $+90^{\circ}\text{C}$. Diffusore direzionabile.

LED Lampadine LED GX53 7W incluse.
CCT regolabile: 3000 K, 4000 K, 6500 K.



145303



145327



145341

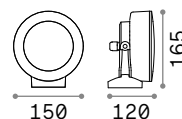

IP66

0,690 Kg / 0,0044 m³
GX53 max 1x10W

€ 95

145303 ■ Bianco
145327 ■ Grigio
145341 ■ Nero

4000 K
1000 lm

154008 € 5,50



P. 919



Terra

Montatura in fusione d'alluminio verniciata. Corpo luce posizionabile. Diffusore in vetro pirex trasparente.

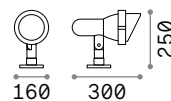

■ IP65

1,140 Kg / 0,0091 m³
E27 max 1x 42W

€ 85

046167 ■ Antracite

4000 K
600 lm

151960 € 2,00

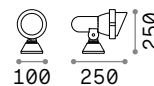

■ IP65

0,530 Kg / 0,0024 m³
GU10 max 1x 28W

€ 45

046181 ■ Antracite

4000 K
430 lm

253497 € 3,00



P. 920



Gas ^{new}

Corpo luce in alluminio pressofuso verniciato a polveri. Diffusore in vetro temperato trasparente sabbiato. Disponibile nelle finiture antracite, bianco, coffee, grigio o nero.



091518

322407

091525

020228

213095





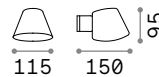

P. 890



■  IP43

0,320 Kg / 0,0020 m³
GU10 max 1x28W

€ 50

091518  Bianco
322407  Grigio ^{new}
091525  Antracite
020228  Nero
213095  Coffee

 4000 K
430 lm

253497

€ 3,00



Xeno

Corpo luce in alluminio rifinito con vernice opaca a polveri. Diffusori orientabili con vetro temperato trasparente. Disponibile nelle finiture bianco, grigio o nero.



129488



129464



129471

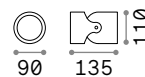

IP44

0,360 Kg / 0,0014 m³
GU10 max 1x28W

€ 35

129488 ■ Bianco
129471 ■ Grigio
129464 ■ Nero

4000 K
430 lm

253497 € 3,00



P. 812



Swipe ^{new}

Corpo luce in alluminio verniciato a polveri. Diffusore orientabile con schermo in policarbonato opale lucido. Disponibile con sensore crepuscolare e di movimento. Finiture: antracite, bianco, grigio, coffee oppure nero.

LED Sorgente luminosa LED 3000 K, 50.000 h di durata.

 Lampada con rilevazione di presenza inclusa PIR (Passive InfraRed).

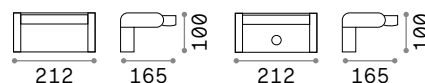
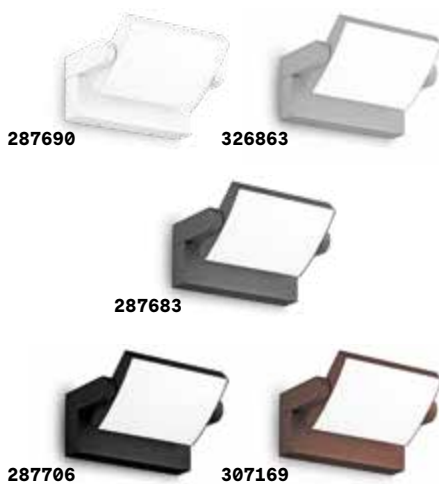

 IP54

1,200 Kg / 0,0055 m³
LED 20,5W / 2000 lm





€ 115

287690  Bianco
326863  Grigio
287683  Antracite
287706  Nero
307169  Coffee

 IP54

1,300 Kg / 0,0055 m³
LED 21W / 2000 lm

€ 130

287720  Bianco ^{new}
326870  Grigio ^{new}
287713  Antracite
287737  Nero
307176  Coffee



Style ^{new}

Corpo luce in alluminio verniciato a polveri. Diffusore in materiale plastico opale. Sorgente luminosa a led integrato. Modello AP Sensor dotato di sensore PIR. Disponibile nelle finiture antracite, bianco, coffee, grigio o nero.

LED Sorgente luminosa LED
3000/4000 K, 30.000 h di durata.

 Lampada con rilevazione di presenza inclusa PIR (Passive InfraRed).



269139

322650

246857

322636

322704

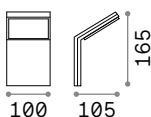

 IP54

0,390 Kg / 0,0018 m³
LED 9W / 1050/1100 lm

€ 135

269139	Bianco	3000K
221502	Bianco	4000K
322650	Grigio	3000K ^{new}
322643	Grigio	4000K ^{new}
246857	Antracite	3000K

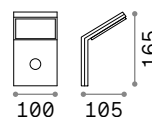

 IP54 

0,400 Kg / 0,0018 m³
LED 9,5W / 1050/1100 lm

€ 165

209845	Antracite	4000K	269146	Bianco	3000K
322636	Nero	3000K ^{new}	209852	Bianco	4000K
322629	Nero	4000K ^{new}	246864	Antracite	3000K
322704	Coffee	3000K ^{new}	221519	Antracite	4000K
322681	Coffee	4000K ^{new}			





Tronco new



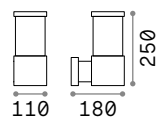

Corpo luce in alluminio pressofuso rifinito in vernice di colore antracite, bianco, coffee, grigio o nero. Diffusore in vetro pirex con elementi interni in alluminio.



■  IP44

1,110 Kg / 0,0070 m³
E27 max 1x 42W

€ 65

118659  Bianco
026978  Grigio
027005  Antracite
004716  Nero
326962  Coffee new

 4000 K
490 lm
153957 € 2,60



Etere ^{new}

Corpo luce in fusione di alluminio verniciato a polveri. Diffusore in materiale plastico color opale. Disponibile nelle finiture antracite, bianco, coffee, grigio o nero.

LED Sorgente luminosa LED
3000/4000 K, 25.000 h di durata.

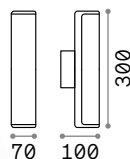

■ (⊕) IP44

0,590 Kg / 0,0027 m³
LED 9,5W / 1150/1350 lm

€ 95

319810	Bianco	3000K	^{new}	172408	Antracite	4000K
322155	Bianco	4000K	^{new}	322193	Nero	3000K
322179	Grigio	3000K	^{new}	322209	Nero	4000K
322186	Grigio	4000K	^{new}	269153	Coffee	3000K
246925	Antracite	3000K		246949	Coffee	4000K





Snif Round

Corpo luce in alluminio pressofuso verniciato. Doppio diffusore, superiore e inferiore, in vetro pirex trasparente. Disponibile nelle finiture antracite, bianco, grigio o nero.

061467



144283



061474



061450

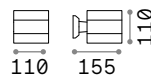

IP54

0,750 Kg / 0,0032 m³
G9 max 1x40W

€ 50

144283 ■ Bianco
061474 ■ Grigio
061467 ■ Antracite
061450 ■ Nero

4000 K
530 lm
307879 € 6,00



Snif Square

Corpo luce in alluminio pressofuso verniciato. Doppio diffusore, superiore e inferiore, in vetro pirex trasparente. Disponibile nelle finiture antracite, bianco, grigio o nero.

121963



144276



118666



123080

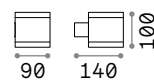

IP44

0,600 Kg / 0,0027 m³
G9 max 1x 40W

€ 50

144276 **Bianco**
118666 **Grigio**
121963 **Antracite**
123080 **Nero**

4000 K
530 lm
307879 € 6,00



Keope

Corpo luce e diffusore in resina ad alte prestazioni: inattaccabile dalla corrosione di agenti atmosferici; colori stabilizzati da trattamento U.V.. Resistente a sbalzi termici da -60° C a +90° C. Diffusori in materiale acrilico trasparente satinato.

LED Lampadine LED GU10 3,5W incluse.
CCT regolabile: 2700 K, 4000 K.



0,450 Kg / 0,0033 m³
GU10 max 2 x 6W

€ 63

147772 Bianco
147796 Grigio
147819 Nero

3000K
410 lm

108292 € 3,00



0,350 Kg / 0,0033 m³
GU10 max 1 x 6W

€ 42

147765 Bianco

3000K
410 lm

108292 € 3,00



Apollo

Corpo luce in alluminio pressofuso rifinito con vernice opaca a polveri in colore nero. Emissione luce sopra e sotto.

LED Sorgente luminosa LED 4000 K, 30.000 h di durata.



IP44

0,540 Kg / 0,0008 m³
LED 6W / 800 lm

€ 90

137391 ■ Nero



Gun

Corpo luce in alluminio con finitura naturale spazzolata o in vernice con varie finiture. Diffusore in vetro pirex trasparente. Emissione luce sopra e sotto.



100388



033013



163628



236841



100395



163635

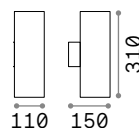

110 150 310



1,350 Kg / 0,0071 m³
E27 max 2 x 60W

€ 72

092300 Bianco
033020 Alluminio
163604 Grigio
236858 Antracite
092317 Nero
163611 Coffee

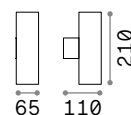

65 110 210



0,720 Kg / 0,0024 m³
GU10 max 2 x 35W

€ 65

100388 Bianco
033013 Alluminio
163628 Grigio
236841 Antracite
100395 Nero
163635 Coffee

4000 K
600 lm
151960 € 2,00

4000 K
430 lm
253497 € 3,00



P. 811



Linea **new**

Base e corpo luce in alluminio verniciato a polveri. Diffusori in vetro. Emissione luce indiretta. Finiture: antracite, bianco, coffee, nero.

LED Sorgente luminosa LED 3000 K, 30.000 h di durata.

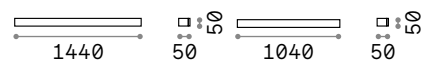

1,750 Kg / 0,0049 m³
LED 23W / 2600 lm

€ 185

1,430 Kg / 0,0036 m³
LED 20W / 1950 lm

€ 145

328584	Bianco	new	313474	Bianco	new
313504	Antracite	new	313467	Antracite	new
328607	Nero	new	313498	Nero	new
328591	Coffee	new	313481	Coffee	new



Punto ^{new}

Base e corpo luce in alluminio verniciato a polveri. Diffusori in vetro. Emissione luce indiretta. Finiture: antracite, bianco, coffee, nero.

LED Sorgente luminosa LED 3000 K, 30.000 h di durata.



313528

313511

313542

313535

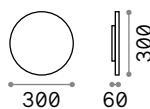

IP54

2,090 Kg / 0,0135 m³
LED 16W / 1850 lm

€ 175

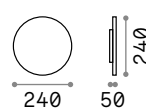

IP54

1,280 Kg / 0,0083 m³
LED 12W / 1400 lm

€ 145

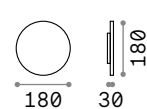

IP54

0,820 Kg / 0,0018 m³
LED 9W / 1050 lm

€ 85

328553	Bianco	new	328522	Bianco	new	313528	Bianco	new
313566	Antracite	new	313559	Antracite	new	313511	Antracite	new
328577	Nero	new	328546	Nero	new	313542	Nero	new
328560	Coffee	new	328539	Coffee	new	313535	Coffee	new



Base

Corpo luce in alluminio pressofuso rifinito con vernice a polveri opaca di colore bianco, grigio o nero. Doppio diffusore, superiore e inferiore, in vetro temperato trasparente.



129457

129440

129433

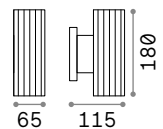

IP44

0,610 Kg / 0,0016 m³
GU10 max 2 x 28W

€ 40

129457 ■ Bianco
129440 ■ Grigio
129433 ■ Nero

4000 K
430 lm
253497 € 3,00



Iko

Corpo luce in alluminio pressofuso verniciato a polveri. Doppio diffusore, superiore e inferiore, in vetro temperato trasparente e sabbiato. Disponibile nelle finiture antracite, bianco o grigio.

018515



092218



018522

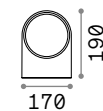
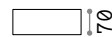

■ IP54

0,600 Kg / 0,0040 m³
E27 max 1x60W

€ 50

018522 ■ Bianco
092218 ■ Grigio
018515 ■ Antracite

4000 K
600 lm

151960 € 2,00



Rubik **new**

Corpo luce in fusione di alluminio verniciato a polveri. Struttura interna che riflette il fascio luminoso sia sopra sia sotto. Disponibile nelle finiture antracite, bianco, coffee, grigio o nero.

LED Sorgente luminosa LED 3000/4000 K, 30.000 h di durata.



■ IP54

0,660 Kg / 0,0022 m³
LED 8,5W / 700/730 lm

€ 135

269313	■ Bianco	3000K	149738	■ Antracite	4000K
149745	■ Bianco	4000K	269320	■ Nero	3000K
326849	■ Grigio	3000K new	142302	■ Nero	4000K
326856	■ Grigio	4000K new	326627	■ Coffee	3000K new
247083	■ Antracite	3000K	326634	■ Coffee	4000K new



Atom ^{new}

Corpo luce in alluminio verniciato a polveri. Diffusori in vetro. Doppio fascio luminoso, sopra e sotto, ad ampiezza regolabile con alette mobili.

LED Sorgente luminosa LED 3000 K, 30.000 h di durata.

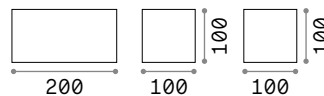

IP54

1,160 Kg / 0,0025 m³
LED 23W / 2100 lm

€ 135

IP54

0,660 Kg / 0,0013 m³
LED 12W / 1050 lm

€ 70

328652	Bianco	new	313436	Bianco	new
313412	Antracite	new	313429	Antracite	new
328676	Nero	new	313450	Nero	new
328669	Coffee	new	313443	Coffee	new

Up ^{new}

Corpo luce in fusione di alluminio verniciato a polveri. Diffusori in vetro pirex trasparente. Disponibile nelle finiture antracite, bianco, coffee, grigio o nero.



■ IP44

0,520 Kg / 0,0019 m³
G9 max 2 x 15W

€ 58

115320 ■ Bianco
326993 ■ Grigio ^{new}
115337 ■ Antracite
115344 ■ Nero
213354 ■ Coffee



■ IP44

0,320 Kg / 0,0012 m³
G9 max 1 x 15W

€ 38

115290 ■ Bianco ^{new}
326986 ■ Grigio ^{new}
115306 ■ Antracite
115313 ■ Nero
213347 ■ Coffee

4000 K
530 lm

307879 € 6,00

4000 K
530 lm

307879 € 6,00



115290

326986

115306

115313

213347



Tetris-1 ^{new}

Corpo luce in alluminio rifinito con vernice opaca a polveri. Diffusore in vetro temperato trasparente. Disponibile nelle finiture antracite, bianco, coffee, grigio o nero.

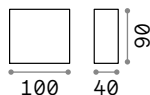

■ IP44

0,390 Kg / 0,0017 m³
G9 max 1 x 15W

€ 82

114293 ■ Bianco
113760 ■ Grigio
113753 ■ Antracite
326955 ■ Nero ^{new}
213323 ■ Coffee

4000 K
530 lm

307879 € 6,00



114293

113760

113753

326955

213323



Tetris-2

Corpo luce in alluminio rifinito con vernice opaca a polveri di colore antracite o bianco. Diffusore in vetro temperato trasparente. Emissione luce sopra e sotto.

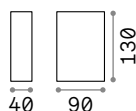

IP44

0,520 Kg / 0,0018 m³
G9 max 2 x 15W

€ 91

269221 Bianco
113791 Antracite

4000 K
530 lm
307879 € 6,00



Argo ^{new}

Corpo luce in alluminio pressofuso verniciato a polveri. Diffusore in vetro temperato trasparente con riflettore interno bianco. Disponibile nelle finiture antracite o bianco.

LED Sorgente luminosa LED
3000/4000 K, 30.000 h di durata.

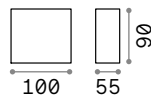

IP65

0,600 Kg / 0,0013 m³
LED 10W / 1050/1150 lm

€ 76

268309 Bianco 3000K
268316 Bianco 4000K
250946 Antracite 3000K
268293 Antracite 4000K

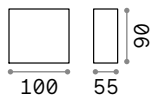

IP65

0,600 Kg / 0,0013 m³
LED 6W / 590/620 lm

€ 70

317564 Bianco 3000K *new*
321691 Bianco 4000K *new*
321646 Antracite 3000K *new*
317571 Antracite 4000K *new*





Twin ^{new}

Corpo luce in alluminio pressofuso verniciato a polveri di colore antracite, bianco, coffee, grigio o nero. Doppio diffusore, superiore e inferiore, in vetro pirex trasparente satinato.

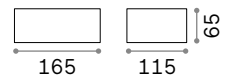

■ IP44

0,510 Kg / 0,0026 m³
G9 max 1x28W

€ 51

- 115351 Bianco
- 326979 Grigio new
- 115368 Antracite
- 115375 Nero
- 213330 Coffee

4000 K
530 lm
307879 € 6,00



Andromeda

Corpo luce in alluminio pressofuso verniciato. Doppio diffusore, superiore e inferiore, in vetro pirex satinato. Disponibile nelle finiture antracite, bianco, coffee, grigio o nero.

100364



163543



092355



100371



163550

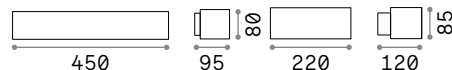

IP55

1,630 Kg / 0,0052 m³
E27 max 2x60W

€ 85

100364 Bianco
163543 Grigio
092355 Antracite
100371 Nero
163550 Coffee

4000 K
600 lm

151960 € 2,00

IP55

1,000 Kg / 0,0039 m³
E27 max 1x60W

€ 55

066868 Bianco
158822 Grigio
061580 Antracite
061597 Nero
163536 Coffee

4000 K
600 lm

151960 € 2,00



Giove new

Corpo luce in alluminio pressofuso verniciato a polveri. Doppio diffusore, superiore e inferiore, in vetro temperato trasparente sabbato. Disponibile nelle finiture antracite, bianco, coffee, grigio o nero.

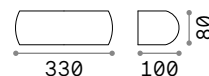

IP54

0,900 Kg / 0,0041 m³
E27 max 1x 60W

€ 70

092195 ■ Bianco
322605 ■ Grigio new
092188 ■ Antracite
092201 ■ Nero
163598 ■ Coffee

4000 K
600 lm

151960 € 2,00



Felix

Corpo luce e diffusore in resina ad alte prestazioni: inattaccabile dalla corrosione sia di agenti atmosferici che di fertilizzanti chimici, colori stabilizzati da trattamento U.V., resistente a sbalzi termici da -60° C a +90° C.

LED

Lampadine LED E27 8W Goccia incluse nel modello **123745**. CCT regolabile: 2700 K, 4000 K, 6500 K.



123776



123769



123783

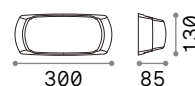
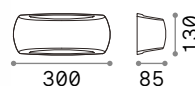

0,520 Kg / 0,0050 m³
E27 max 1x23W

€ 52

0,610 Kg / 0,0050 m³
E27 max 1x23W

€ 35

123745 Bianco

123776 Bianco

123769 Grigio

123783 Nero

4000 K
600 lm

151960

€ 2,00

4000 K
600 lm

151960

€ 2,00



Rex-1 **new**



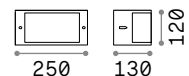

Corpo luce in alluminio pressofuso verniciato a polveri di colore antracite, bianco, coffee, grigio o nero. Diffusore bianco in materiale acrilico.



■  IP44

0,600 Kg / 0,0065 m³
E27 max 1x 60W

€ 42

092393  Bianco
322735  Grigio **new**
092409  Antracite
322728  Nero **new**
213217  Coffee

 4000 K
1000 lm

151991 € 2,00

Rex-2

Corpo luce in alluminio pressofuso verniciato a polveri di colore antracite o bianco. Diffusore bianco in materiale acrilico.

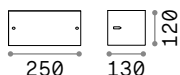

IP44

0,600 Kg / 0,0065 m³
E27 max 1x60W

€ 42

092416 ■ Bianco
092423 ■ Antracite

4000 K
1000 lm

151991 € 2,00



Rex-3

Corpo luce in alluminio pressofuso verniciato a polveri di colore antracite o bianco. Diffusore bianco in materiale acrilico.

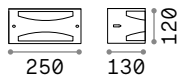

IP44

0,600 Kg / 0,0065 m³
E27 max 1x60W

€ 42

092430 ■ Bianco
092447 ■ Antracite

4000 K
1000 lm

151991 € 2,00





Cometa

Corpo luce in alluminio pressofuso rifinito con vernice a polveri di colore antracite o nero. Diffusore in PVC bianco. È sconsigliato esporre l'articolo a contatto diretto con i raggi solari.



082240



082271

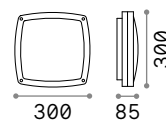

1,500 Kg / 0,0124 m³
E14 max 3x28W

€ 100

082240 ■ Antracite
082271 ■ Nero

3000 K
420 lm

101217 € 2,50

Polar

Corpo luce e diffusore in resina ad alte prestazioni: inattaccabile dalla corrosione sia di agenti atmosferici che di fertilizzanti chimici, colori stabilizzati da trattamento U.V., resistente a sbalzi termici da -60°C a $+90^{\circ}\text{C}$.

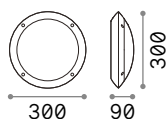

0,800 Kg / 0,0106 m³
E27 max 1x23W

€ 31

096667 Bianco
096674 Nero

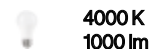

151991 € 2,00

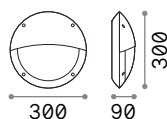

0,800 Kg / 0,0106 m³
E27 max 1x23W

€ 31

096681 Bianco
096698 Nero

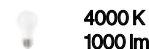

151991 € 2,00



096681

096698

Medea

Corpo luce e diffusore in resina ad alte prestazioni: inattaccabile dalla corrosione sia di agenti atmosferici che di fertilizzanti chimici, colori stabilizzati da trattamento U.V., resistente a sbalzi termici da -60°C a $+90^{\circ}\text{C}$.

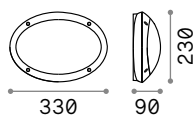

0,800 Kg / 0,0109 m³
E27 max 1x23W

€ 23

096711 Bianco
096704 Nero

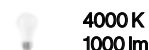

151991 € 2,00

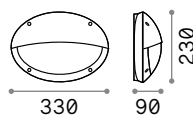

0,800 Kg / 0,0109 m³
E27 max 1x23W

€ 23

096735 Bianco
096728 Nero

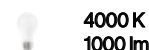

151991 € 2,00



096735

096728



Bubble

Montatura in alluminio pressofuso e tornito rifinito con vernici a polveri. Diffusore in materiale plastico bianco opaco.

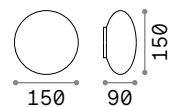

0,480 Kg / 0,0031 m³
G9 max 2x15W

€ 72

158907 Bianco

4000 K
530 lm

307879 € 6,00



P. 814



Clio new

Articolo componibile con montatura in alluminio estruso e tornito, rifinito con vernici a polveri di colore antracite, bianco, grigio, nero e coffee. Diffusore in materiale plastico bianco opaco.



■ IP44

0,680 Kg / 0,0039 m³
E27 max 1x 42W

€ 71

146775 ■ Bianco
146782 ■ Grigio
145228 ■ Antracite
146799 ■ Nero
326788 ■ Coffee new

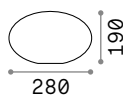

0,540 Kg / 0,0171 m³

€ 35

145068 ■ Bianco

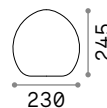

0,520 Kg / 0,0144 m³

€ 35

116716 ■ Bianco

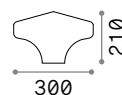

0,610 Kg / 0,0231 m³

€ 35

145020 ■ Bianco



P. 808 P. 808 P. 906

4000 K
600 lm
151960 € 2,00



Cima

Corpo luce interamente in alluminio pressofuso. Con finitura antracite, coffee o nero e oro. Diffusore in acrilico trasparente.

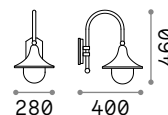

IP43

1,840 Kg / 0,0504 m³
E27 max 1x 60W

€ 61

246819 ■ Antracite
024134 ■ Nero
246826 ■ Coffee

4000 K
980 lm

153964 € 6,00



P. 908



Dafne

Corpo luce in resina ad alte prestazioni: inattaccabile dalla corrosione, colori stabilizzati da trattamento U.V., resistente a sbalzi termici da -60° C a +90° C. Diffusore in metacrilato antingiallimento.



120423



101491

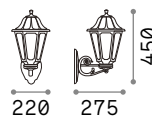

220 275 450

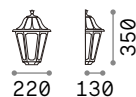

220 130 350



IP55



IP55

1,000 Kg / 0,0101 m³
E27 max 1x23W

€ 33

0,600 Kg / 0,0117 m³
E27 max 1x23W

€ 28

120423 ■ Bianco
101491 ■ Nero

120430 ■ Bianco
101552 ■ Nero

4000 K
980 lm

153964

€ 6,00

4000 K
980 lm

153964

€ 6,00



P. 909

Down

Montatura in alluminio pressofuso verniciato a polveri con finitura antracite o bianca. Diffusore in acrilico.

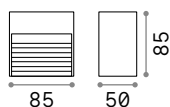

■ IP44

0,270 Kg / 0,0010 m³
G9 max 1x28W

€ 30

115382 ■ Bianco
122045 ■ Antracite

4000 K
530 lm

307879 € 6,00



Febe ^{new}

Apparecchio da installazione su superficie con corpo luce in alluminio pressofuso verniciato a polveri. Diffusore in vetro temperato trasparente. Disponibile nelle finiture antracite o bianco.

LED Sorgente luminosa LED 3000/4000 K, 30.000 h di durata.

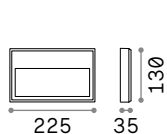

■ IP65

0,760 Kg / 0,0020 m³
LED 6W / 600/630 lm

€ 83

268347 ■ Bianco 3000K
322292 ■ Bianco 4000K ^{new}
250854 ■ Antracite 3000K
322285 ■ Antracite 4000K ^{new}

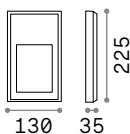

■ IP65

0,760 Kg / 0,0020 m³
LED 6W / 500/520 lm

€ 80

268361 ■ Bianco 3000K
322315 ■ Bianco 4000K ^{new}
268354 ■ Antracite 3000K
322308 ■ Antracite 4000K ^{new}





Dedra ^{new}

Corpo luce in alluminio pressofuso verniciato a polveri. Diffusore in acrilico trasparente. Emissione luce indiretta. Finiture: bianco, antracite, coffee.

LED Sorgente luminosa LED 3000 K, 30.000 h di durata.

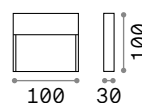

■ □ IP65

0,200 Kg / 0,0007 m³
LED 3W / 200 lm

€ 47

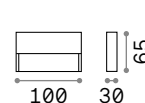

■ □ IP65

0,170 Kg / 0,0007 m³
LED 3W / 200 lm

€ 43

328638	■ Bianco	new	316901	■ Bianco	new
316871	■ Antracite	new	328645	■ Antracite	new
328621	■ Coffee	new	316895	■ Coffee	new



Esterni

Bollard e lampade da tavolo



Indice alfabetico

Acqua	900	Tesla	888
Agos	878	Tifone	892
Arcadia	877	Titano	884
Atena	898	Toffee	867
Cima	908	Toki	866
Clio	906	Torre	904
Cosmo	905	Tronco	896
Dafne	909	Vega	894
Djambe	870	Venus	899
Doris	872		
Edo Outdoor	901		
Etere	902		
Gas	890		
Hub	891		
Ipotesi	893		
Itaca	876		
Jedi	895		
Kurt	885		
Lolita	865		
Luna	874		
Marte	886		
Mercurio	887		
Path	889		
Pulsar	899		
Pure	864		
Sasso	875		
Sirio	882		
Sole	873		
Stardust	868		
Style	880		
Sun	869		



Arcadia

Pag 877



new



Pure 864



Lolita 865

new



Toki 866

new



Toffee 867

new



Itaca 876



Arcadia 877

new



Agos 878

new



Style 880

new



Gas 890



Hub 891



Tifone 892



Ipotesi 893

new



Edo Outdoor 901



Etere 902



Stardust 868



Sun 869



Djambe 870



Doris 872



new

Sole 873



Luna 874



Sasso 875



Sirio 882



Titano 884



Kurt 885



Marte 886



Mercurio 887

new



Tesla 888



Path 889



Vega 894



Jedi 895



Tronco 896



Atena 898



Pulsar 899



Venus 899



Acqua 900

new



Torre 904



Cosmo 905

new



Clio 906

new



Clio 906

new



Clio 906



Cima 908



Dafne 909



Pure **new**

Base, stelo e paralume in metallo verniciato opaco. Diffusore in acrilico. Batteria ricaricabile e interruttore touch integrato. Finiture: bianco, coffee, nero. Tempo di ricarica della batteria 6 ore.



Sorgente luminosa LED 3000 K, 30.000 h di durata.



Lampada con interruttore integrato.



Lampada con dimmer.



Lampada con dimmer tattile.



Lampada con batteria ricaricabile inclusa. Durata 7 ore.



311708



328515



328508



IP54

1,580 Kg / 0,0058 m³
LED 1,5W / 230 lm

€ 125

311708 **Bianco**

328515 **Nero**

328508 **Coffee**

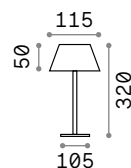

IP54

0,840 Kg / 0,0052 m³
LED 1,5W / 230 lm

€ 80

new 311685 **Bianco** new

new 311678 **Nero** new

new 311661 **Coffee** new

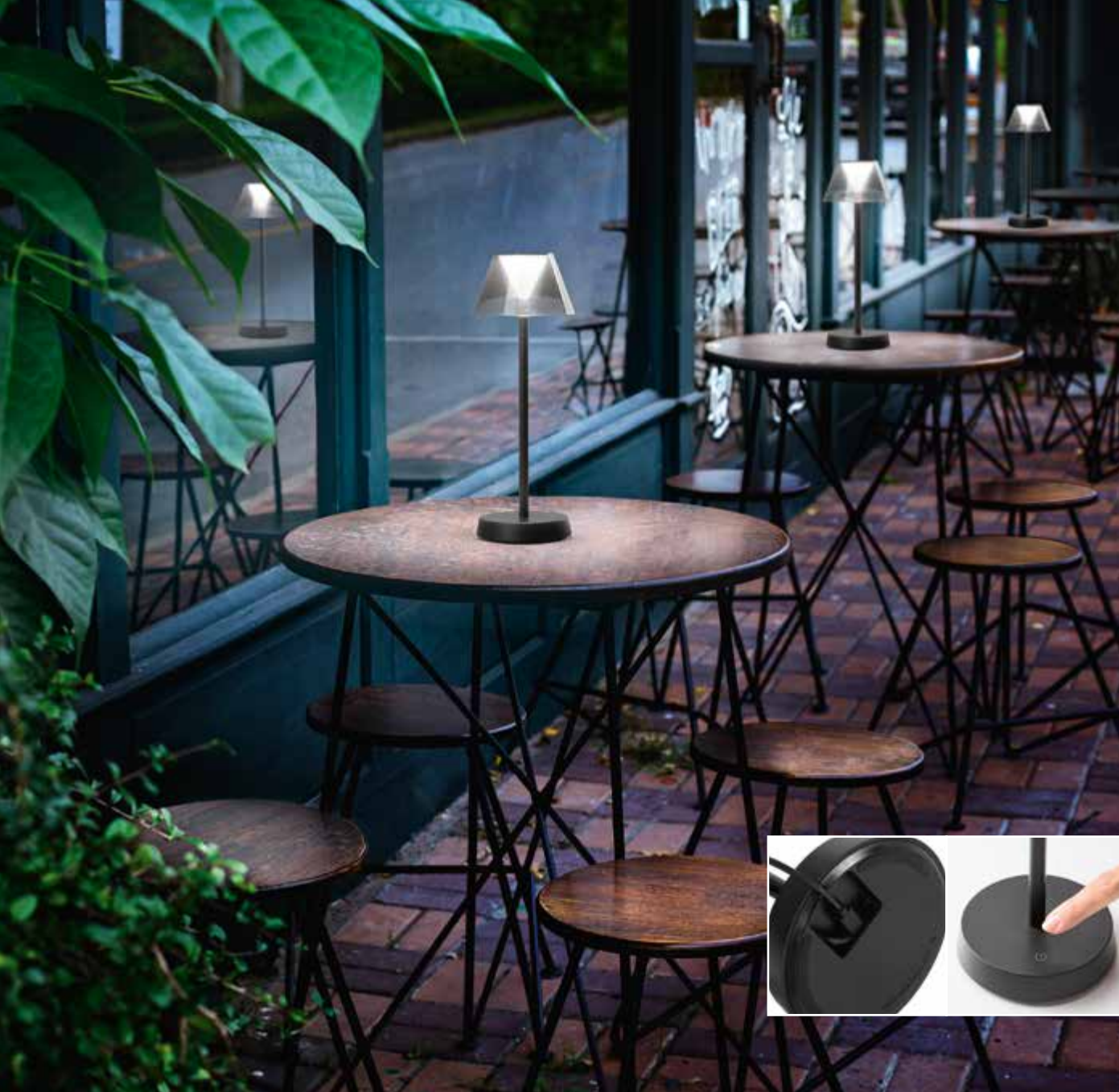

Lolita

Lampada da tavolo a batteria ricaricabile con finitura bianca, grigia, nera o coffee. Base in plastica. Montatura in metallo. Diffusore in materiale plastico. Autonomia di 14 ore. Tempo di ricarica della batteria 7 ore.

LED Sorgente luminosa LED 3000 K, 25.000 h di durata.

ON/OFF Lampada con interruttore integrato.

+ Lampada con dimmer.

Hand icon Lampada con dimmer tattile.

Battery icon Lampada con batteria ricaricabile inclusa. Durata 14 ore.

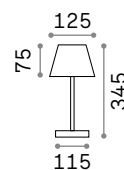

IP54

0,550 Kg / 0,0078 m³
LED 2,8W / 250 lm

€ 55

286723 Bianco
286730 Grigio
286716 Nero
286747 Coffee



Toki new

Lampada da tavolo a batteria. Base e paralume in metallo verniciato opaco. Stelo in acrilico trasparente. Base, stelo e paralume uniti da magneti. Sorgente e batteria interne al paralume. Finiture: bianco, nero.



Sorgente luminosa LED 3000 K, 30.000 h di durata.



Lampada con interruttore integrato.



Lampada con dimmer.



Lampada con dimmer tattile.



Lampada con batteria ricaricabile inclusa. Durata 5 ore.

309873



309866

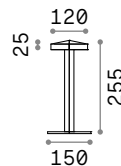

IP20

1,000 Kg / 0,0056 m³
LED 3,6W / 380 lm

€ 100

309873 ■ Bianco new
309866 ■ Nero new



Toffee ^{new}

Lampada da tavolo a batteria. Base, stelo e paralume in metallo verniciato opaco. Diffusore in acrilico. Interruttore integrato sulla base. Finiture: bianco, nero. Tempo di ricarica della batteria 7 ore.

LED Sorgente luminosa LED 3000 K, 30.000 h di durata.

ON OFF Lampada con interruttore integrato.

Hand icon Lampada con interruttore tattile.

Battery icon Lampada con batteria ricaricabile inclusa. Durata 8 ore.

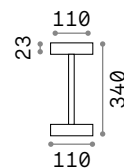

IP54

0,460 Kg / 0,0050 m³
LED 1,5W / 150 lm

€ 80

311715 **Bianco** ^{new}
328614 **Nero** ^{new}



Stardust

Lanterna portatile a batteria. Montatura in alluminio pressofuso verniciato a polveri con finitura antracite con elementi in vetro nero sulla parte superiore. Diffusore in vetro temperato trasparente. Emissione luce verso il basso.

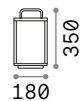
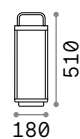

Sorgente luminosa LED 3000 K, 20.000 h di durata.



Lampada con interruttore integrato.



Lampada con dimmer.



Lampada con batteria ricaricabile inclusa. Durata 7 ore.



2,780 Kg / 0,0191 m³
LED 3W / 330 lm

€ 147

250885 ■ Antracite



2,630 Kg / 0,0130 m³
LED 3W / 330 lm

€ 135

250878 ■ Antracite



Sun

Apparecchio portatile a batteria.
Base in alluminio verniciato a polveri.
Diffusore in vetro bianco soffiato e acidato. Finiture: bianco. Autonomia di 7 ore. Tempo di ricarica della batteria 4 ore.



LED Sorgente luminosa LED 3000 K,
30.000 h di durata.

ON/OFF Lampada con interruttore integrato.

BATTERY Lampada con batteria ricaricabile
inclusa. Durata 7 ore.



IP44

0,400 Kg / 0,0097 m³
LED 4W / 700 lm

€ 85

278148 Bianco



Djambe

Corpo luce in metallo verniciato a polveri. Diffusore in materiale plastico opale ruvido. Emissione luce in basso. Cavo in neoprene nero con spina. Finiture: coffee oppure nero.

LED Sorgente luminosa LED 3000 K, 30.000 h di durata.

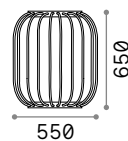

550

650



6,300 Kg / 0,1884 m³
LED 18W / 2300 lm

€ 397

293394 ■ Nero
293387 ■ Coffee

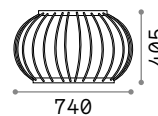

740

405



8,000 Kg / 0,1654 m³
LED 18W / 2300 lm

€ 479

293424 ■ Nero
293417 ■ Coffee



Doris

Diffusore in materiale plastico grigio melange effetto granito. Fornito con spina e picchetto per fissaggio nel terreno.

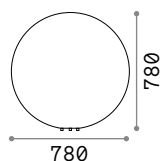

7,600 Kg / 0,5581 m³
E27 max 1x60W

€ 545

195506 Bianco



151991 € 2,00

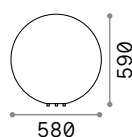

4,050 Kg / 0,2306 m³
E27 max 1x60W

€ 325

195490 Bianco

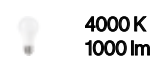

151991 € 2,00

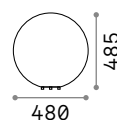

3,000 Kg / 0,1366 m³
E27 max 1x60W

€ 215

195483 Bianco

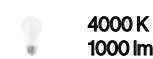

151991 € 2,00

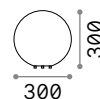

1,210 Kg / 0,0318 m³
E27 max 1x60W

€ 127

214009 Bianco

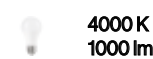

151991 € 2,00



Sole new

Diffusore in materiale plastico opale. Fornito con spina e picchetto per terreno.

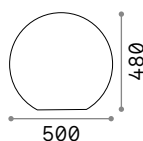

IP44

4,500 Kg / 0,1460 m³
E27 max 1x 60W

€ 225

191614 Bianco

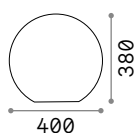

IP44

3,900 Kg / 0,0741 m³
E27 max 1x 60W

€ 150

191621 Bianco

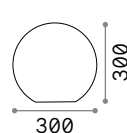

IP44

2,700 Kg / 0,0322 m³
E27 max 1x 60W

€ 120

191638 Bianco

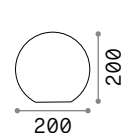

IP44

1,200 Kg / 0,0139 m³
E27 max 1x 60W

€ 110

318820 Bianco new



P. 806

4000 K
1000 lm
151991 € 2,00

4000 K
1000 lm
151991 € 2,00

4000 K
1000 lm
151991 € 2,00

4000 K
600 lm
151960 € 2,00



Luna

Corpo luce diffusore in materiale plastico opale. Fornito con spina e picchetto per terreno.

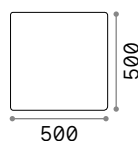

IP44

6,700 Kg / 0,1743 m³
E27 max 1x60W

€ 290

191607 Bianco

4000 K
1000 lm

151991 € 2,00

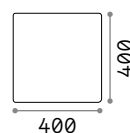

IP44

4,700 Kg / 0,1005 m³
E27 max 1x60W

€ 210

191584 Bianco

4000 K
1000 lm

151991 € 2,00

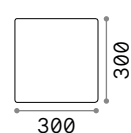

IP44

2,700 Kg / 0,0356 m³
E27 max 1x60W

€ 150

191577 Bianco

4000 K
1000 lm

151991 € 2,00



P. 807



Sasso

Diffusore in materiale plastico opale. Fornito di cavo con spina e picchetto per fissaggio a terra.

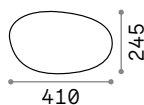

1,500 Kg / 0,0444 m³
E27 max 1x 40W

€ 205

161778 Bianco

4000 K
1000 lm
151991 € 2,00

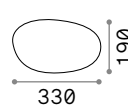

0,900 Kg / 0,0209 m³
E27 max 1x 40W

€ 145

161761 Bianco

4000 K
1000 lm
151991 € 2,00

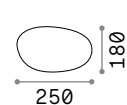

0,710 Kg / 0,0123 m³
G9 max 1x 15W

€ 105

161754 Bianco

4000 K
530 lm
307879 € 6,00



Itaca

Base e stelo in metallo verniciato a polveri di colore bianco. Diffusore conico in materiale plastico color opale. Fornito con spina.

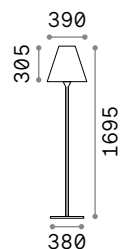

IP44

8,840 Kg / 0,1405 m³
E27 max 1x60W

€ 310

180953 Bianco

4000 K
1000 lm

151991 € 2,00



Arcadia new

Base e stelo in metallo verniciato a polveri. Diffusore in PMMA bianco. Cavo in neoprene con spina. Finiture: antracite.

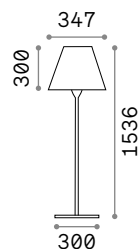

6,500 Kg / 0,0525 m³
E27 max 1x42W

€ 145

298610 ■ Antracite new

4000 K
1000 lm

151991 € 2,00

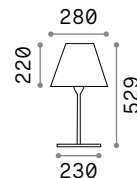

2,940 Kg / 0,0247 m³
E27 max 1x42W

€ 110

298597 ■ Antracite new

4000 K
1000 lm

151991 € 2,00



Agos new

Corpo luce in alluminio pressofuso verniciato a polveri. Diffusore in acrilico trasparente satinato. Colore antracite, coffee e nero.

LED Sorgente luminosa LED
3000/4000 K, 25.000 h di durata.



254388

326696

326689

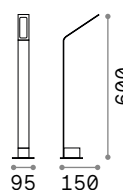

1,100 Kg / 0,0127 m³
LED 6,5W / 670/730 lm

0,950 Kg / 0,0096 m³
LED 6,5W / 670/730 lm

€ 140

€ 120

254319	■ Antracite	3000K	254388	■ Antracite	3000K
268422	■ Antracite	4000K	268439	■ Antracite	4000K
326733	■ Nero	3000K <small>new</small>	326696	■ Nero	3000K <small>new</small>
326757	■ Nero	4000K <small>new</small>	326719	■ Nero	4000K <small>new</small>
326726	■ Coffee	3000K <small>new</small>	326689	■ Coffee	3000K <small>new</small>
326740	■ Coffee	4000K <small>new</small>	326702	■ Coffee	4000K <small>new</small>



Style new

Corpo luce in alluminio verniciato a polveri. Diffusore in materiale plastico opale. Sorgente luminosa a led integrato. Disponibile nelle finiture antracite, bianco, coffee, grigio o nero.

LED Sorgente luminosa LED
3000/4000 K, 30.000 h di durata.

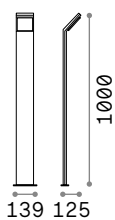

IP54

1,680 Kg / 0,0239 m³
LED 9W / 1050 / 1100 lm

€ 190

318707	Bianco	3000K	new	209906	Antracite	4000K
322483	Bianco	4000K	new	322230	Nero	3000K
322384	Grigio	3000K	new	322216	Nero	4000K
322353	Grigio	4000K	new	322452	Coffee	3000K
246871	Antracite	3000K		322438	Coffee	4000K

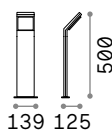

IP54

1,200 Kg / 0,0122 m³
LED 9W / 1050 / 1100 lm

€ 145

318691	Bianco	3000K	new	322599	Antracite	4000K	new
322582	Bianco	4000K	new	322537	Nero	3000K	new
322551	Grigio	3000K	new	322506	Nero	4000K	new
322544	Grigio	4000K	new	322575	Coffee	3000K	new
322612	Antracite	3000K	new	322568	Coffee	4000K	new



Sirio

Corpo luce in alluminio verniciato a polveri. Diffusore in vetro pirex trasparente. Disponibile nelle finiture antracite, bianco, coffee, grigio o nero.



115085

246963

115061

115108

213262

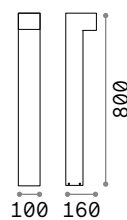

IP44

1,880 Kg / 0,0181 m³
G9 max 2x 15W

€ 165

115085 Bianco
246963 Grigio
115061 Antracite
115108 Nero
213262 Coffee

 4000 K
530 lm
307879 € 6,00

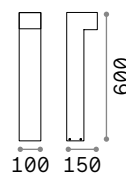

IP44

1,550 Kg / 0,0136 m³
G9 max 2x 15W

€ 130

115092 Bianco
246970 Grigio
115078 Antracite
115115 Nero
213279 Coffee

 4000 K
530 lm
307879 € 6,00



Titano

Corpo luce in resina porosa. Base e dettaglio diffusore in metallo verniciato nero opaco. Emissione luce verso il basso. LED integrato.



Sorgente luminosa LED
3000/4000 K, 50.000 h di durata.

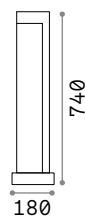

9,220 Kg / 0,0540 m³
LED 9W / 430/450 lm

€ 300

246987 ■ Granito 3000K
187327 ■ Granito 4000K

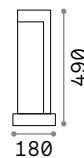

6,800 Kg / 0,0377 m³
LED 9W / 430/450 lm

€ 250

246994 ■ Granito 3000K
157856 ■ Granito 4000K



Kurt

Base e corpo luce in alluminio verniciato a polveri. Diffusore in vetro trasparente. Emissione luce verso il basso. Finiture: antracite, bianco, coffee, grigio oppure nero.

LED Sorgente luminosa LED
3000/4000 K, 30.000 h di durata.



IP54

1,930 Kg / 0,0060 m³
LED 12W / 1200 / 1250 lm

€ 125

306841	Bianco	3000K
294049	Bianco	4000K
306865	Grigio	3000K
294032	Grigio	4000K
306834	Antracite	3000K

294025	Antracite	4000K
306872	Nero	3000K
293172	Nero	4000K
306858	Coffee	3000K
294001	Coffee	4000K

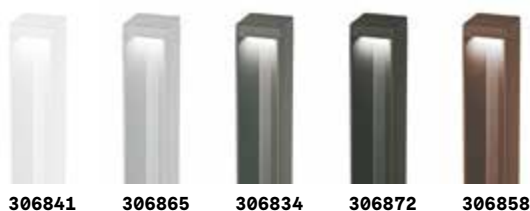

306841 306865 306834 306872 306858



Marte

Corpo luce in alluminio verniciato a polveri con finitura antracite. Diffusore bianco in materiale acrilico.

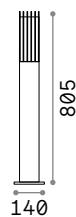

IP44

2,500 Kg / 0,0193 m³
E27 max 1x25W

€ 160

092225 ■ Antracite

4000 K
1000 lm

151991 € 2,00



Mercurio

Corpo luce in alluminio verniciato a polveri con finitura antracite. Diffusore in vetro pirex trasparente.

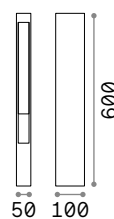

IP44

1,540 Kg / 0,0057 m³
G9 max 1x 15W

€ 160

114347 ■ Antracite

4000 K
530 lm

307879 € 6,00



Tesla **new**

Corpo luce in alluminio verniciato a polveri. Diffusore con schermo in materiale plastico bianco. Emissione luce verso il basso. Disponibile nelle finiture antracite, bianco, coffee, grigio o nero.

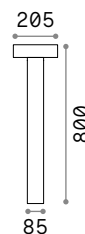

IP44

3,000 Kg / 0,0379 m³
G9 max 4x15W

€ 155

153179 **Bianco**
326931 **Grigio**
153162 **Antracite**
316055 **Nero**
326924 **Coffee**

4000 K
530 lm

307879 € 6,00



IP44

2,560 Kg / 0,0273 m³
G9 max 4x15W

€ 145

153209 **Bianco**
326900 **Grigio** **new**
153193 **Antracite**
326917 **Nero** **new**
316048 **Coffee** **new**

4000 K
530 lm

307879 € 6,00



Path

Corpo luce in alluminio verniciato a polveri. Diffusore in policarbonato opale. Colore: antracite metallizzato.

LED Sorgente luminosa LED
3000/4000 K, 20.000 h di durata.



285542-250816



285559-250823

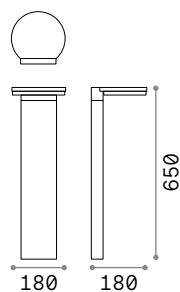

IP65

1,900 Kg / 0,0238 m³
LED 10W / 1200/1250 lm

€ 135

285542 ■ Antracite 3000K
250816 ■ Antracite 4000K

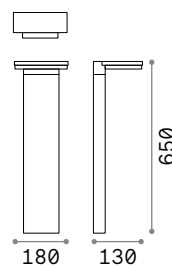

IP65

1,840 Kg / 0,0163 m³
LED 10W / 1200/1250 lm

€ 135

285559 ■ Antracite 3000K
250823 ■ Antracite 4000K



Gas **new**

Corpo luce in alluminio pressofuso verniciato a polveri. Diffusore in vetro temperato trasparente sabbato. Disponibile nelle finiture antracite, bianco, coffee, grigio o nero.



319704

322414

139470

322421

213101

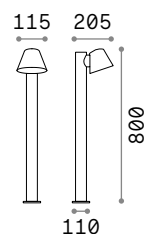

IP43

1,790 Kg / 0,0216 m³
GU10 max 1x35W

€ 116

319704 Bianco **new**

322414 Grigio **new**

139470 Antracite

322421 Nero **new**

213101 Coffee

4000 K
430 lm

253497 € 3,00



P. 825



Hub

Base, asta e corpo luce in alluminio verniciato a polveri. Diffusore orientabile con schermo in vetro temperato trasparente. Fornito di picchetto per fissaggio a terra. Disponibile nella finitura antracite.

LED Sorgente luminosa LED
3000 K, 30.000 h di durata.

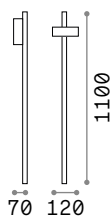

IP54

0,850 Kg / 0,0057 m³
LED 4,5W / 410 lm

€ 132

251257 ■ Antracite

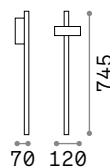

IP54

0,720 Kg / 0,0083 m³
LED 4,5W / 410 lm

€ 132

251226 ■ Antracite



Base
Non incluso
Optional

€ 32

251295 ■ Antracite



Tifone

Base e montatura in alluminio pressofuso verniciato a polveri con finitura antracite. Diffusore in vetro temperato trasparente. Emissione luce in basso.

LED Sorgente luminosa LED
3000 K, 20.000 h di durata.

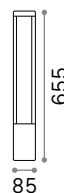

IP65

1,250 Kg / 0,0054 m³
LED 8,5W / 720 Lm

€ 122

250953 ■ Antracite

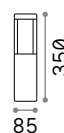

IP65

1,010 Kg / 0,0029 m³
LED 8,5W / 720 Lm

€ 105

250977 ■ Antracite



Ipotesi

Montatura interamente in alluminio verniciato a polveri. Diffusore in policarbonato opale. Cavo nero in gomma con interruttore, driver esterno incorporato e spina. Colore: bianco o nero.

LED Sorgente luminosa LED
3000 K, 30.000 h di durata.



282244



282251

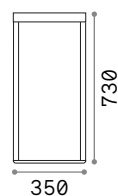

350

730

IP44

5,100 Kg / 0,1041 m³
LED 16W / 1800 Lm

€ 335

282244 ■ Bianco
282251 ■ Nero

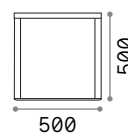

500

500

IP44

4,940 Kg / 0,1379 m³
LED 16W / 1800 Lm

€ 435

300641 ■ Bianco
300658 ■ Nero



Vega

Corpo luce in alluminio con finitura in vernice opaca a polveri. Diffusore in vetro temperato trasparente. Disponibile nelle finiture antracite, bianco, coffee, grigio o nero.

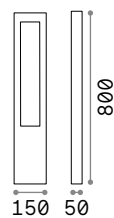

IP44

1,150 Kg / 0,0092 m³
G9 max 1x15W

€ 180

- 136035 Bianco
- 136042 Grigio
- 136028 Antracite
- 136059 Nero
- 213361 Coffee

4000 K
530 lm
307879 € 6,00



Jedi

Base e corpo luce in alluminio verniciato a polveri. Diffusore in policarbonato opale lucido. Fornito con picchetto per installazione su terreno. Finiture: antracite oppure nero.

LED Sorgente luminosa LED 3000 K, 30.000 h di durata.



306803



293202

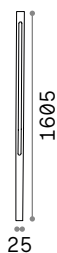

1,280 Kg / 0,0165 m³
LED 25W / 2900 Lm

€ 135

306803 ■ Antracite
293202 ■ Nero

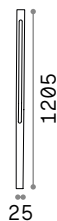

1,030 Kg / 0,0150 m³
LED 19W / 2250 Lm

€ 110

306797 ■ Antracite
293196 ■ Nero

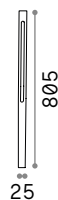

0,760 Kg / 0,0036 m³
LED 12W / 1400 Lm

€ 80

306780 ■ Antracite
293189 ■ Nero



Base
Non incluso
Optional

€ 10

308227 ■ Antracite
308234 ■ Nero

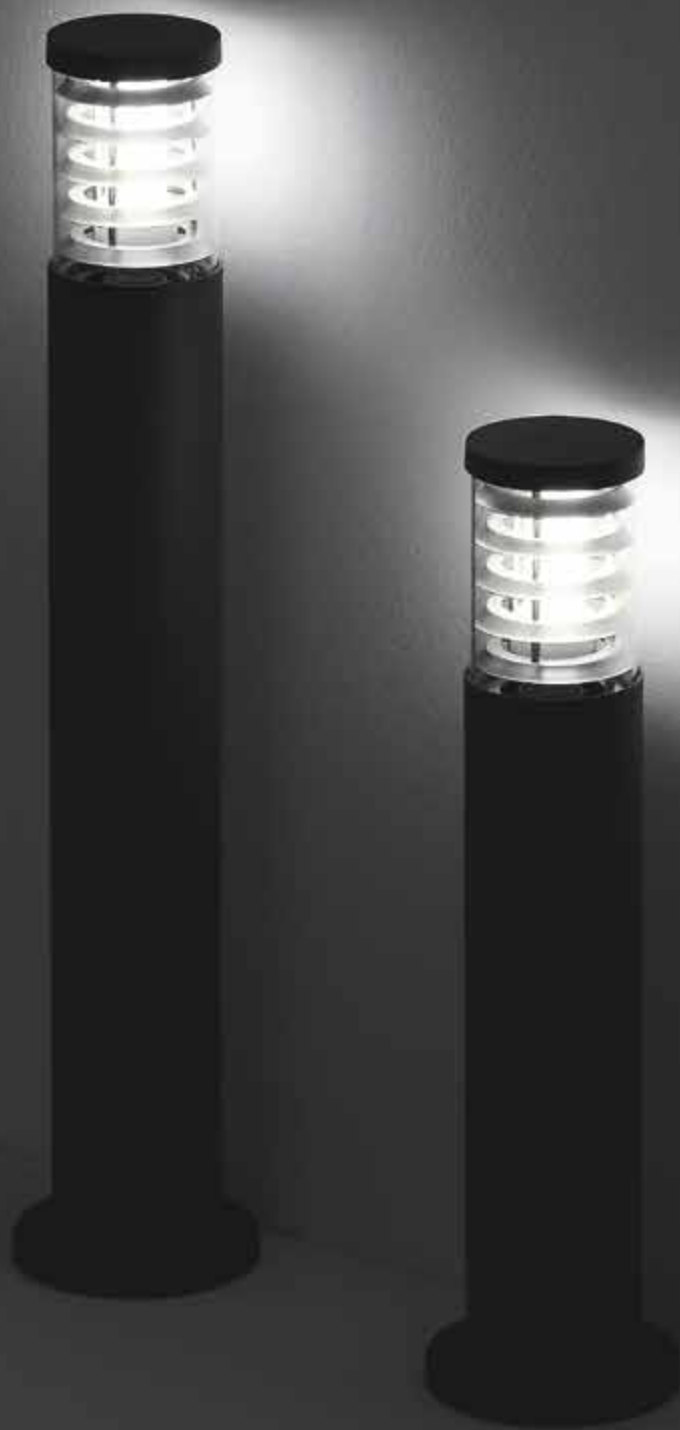

Tronco

Corpo luce in alluminio pressofuso rifinito in vernice di colore antracite, bianco, coffee, grigio o nero. Diffusore in vetro pirex con elementi interni in alluminio.

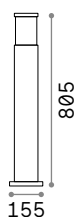

IP65

2,490 Kg / 0,0254 m³
E27 max 1x 42W

€ 146

109138 Bianco
026961 Grigio
026992 Antracite
004723 Nero
163741 Coffee



4000 K
490 lm

153957 € 2,60

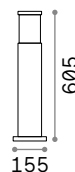

IP65

1,970 Kg / 0,0193 m³
E27 max 1x 42W

€ 125

109145 Bianco
026954 Grigio
026985 Antracite
004730 Nero
163758 Coffee



4000 K
490 lm

153957 € 2,60

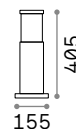

IP65

0,590 Kg / 0,0135 m³
E27 max 1x 42W

€ 113

248264 Bianco
248288 Grigio
248257 Antracite
248295 Nero
248271 Coffee



4000 K
490 lm

153957 € 2,60



P. 830



Atena

Corpo luce e diffusore in resina ad alte prestazioni: anti corrosione, colori stabilizzati da trattamento U.V., resistente da -60° C a + 90° C.

LED

Lampadine LED E27 8W Goccia incluse. CCT regolabile: 2700 K, 4000 K, 6500 K.

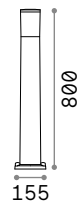

IP55

1,070 Kg / 0,0220 m³
E27 max 1x23W

€ 83

198644 ■ Bianco
198637 ■ Grigio
198620 ■ Nero

4000 K
1000 lm

151991 € 2,00

Pulsar

Montatura in fusione d'alluminio verniciato a polveri di colore antracite, coffee o grigio. Diffusore in policarbonato bianco.

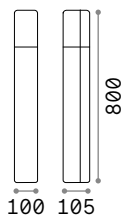

IP44

1,900 Kg / 0,0120 m³
E27 max 1x 42W

€ 200

135922 ■ Grigio
135908 ■ Antracite
246888 ■ Coffee

4000 K
600 lm

151960 € 2,00



Venus

Corpo luce in lamina d'acciaio disponibile con finitura antracite. Elemento diffusore superiore in acrilico satinato.

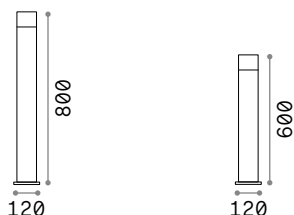

IP44

1,410 Kg / 0,0137 m³
GU10 max 1x 15W

€ 105

106175 ■ Antracite

4000 K
430 lm

253497 € 3,00



IP44

1,070 Kg / 0,0103 m³
GU10 max 1x 15W

€ 95

106182 ■ Antracite

4000 K
430 lm

253497 € 3,00





Acqua

Corpo luce in alluminio tornito
 rifinito in vernice opaca con finitura
 antracite o coffee. Diffusore in vetro
 temperato.



135205



246918

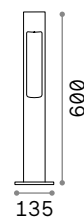

IP44

1,500 Kg / 0,0164 m³
 G9 max 1x 15W

€ 160

135205 ■ Antracite
 246918 ■ Coffee

4000 K
 530 lm
 307879 € 6,00



Edo Outdoor

Montatura in fusione d'alluminio verniciato a polveri di colore antracite, bianco o coffee. Diffusore in policarbonato bianco.

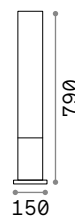
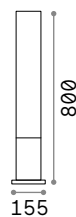

IP44

IP44

1,600 Kg / 0,0240 m³
GX53 max 1x15W

2,670 Kg / 0,0269 m³
GX53 max 1x15W

€ 132

€ 132

135755 Bianco
138510 Antracite
213071 Coffee

142999 Bianco
135762 Antracite
213088 Coffee

4000 K
1000 lm
154008 € 5,50

4000 K
1000 lm
154008 € 5,50



Etere ^{new}

Corpo luce in fusione di alluminio verniciato a polveri. Diffusore in materiale plastico color opale. Disponibile nelle finiture antracite, bianco, coffee, grigio o nero.

LED Sorgente luminosa LED
3000/4000 K, 25.000 h di durata.



IP44

1,100 Kg / 0,0103 m³
LED 9,5W / 1150/1350 lm

€ 127

319827	Bianco	3000K ^{new}	172439	Antracite	4000K
322223	Bianco	4000K ^{new}	322261	Nero	3000K ^{new}
322247	Grigio	3000K ^{new}	322278	Nero	4000K ^{new}
322254	Grigio	4000K ^{new}	269160	Coffee	3000K
246932	Antracite	3000K	246956	Coffee	4000K





Torre **new**

Corpo luce in alluminio tornito verniciato a polveri con finitura antracite, bianco, coffee, grigio o nero. Diffusore in materiale plastico opale.



IP65

2,600 Kg / 0,0307 m³
E27 max 1x 15W

€ 150

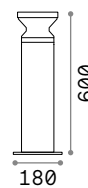

IP65

2,100 Kg / 0,0224 m³
E27 max 1x 15W

€ 140

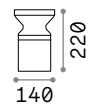

IP65

0,870 Kg / 0,0054 m³
E27 max 1x 15W

€ 120



318714

321950

158891

186979

321981

321875	Bianco	new	318721	Bianco	new	318714	Bianco	new
321851	Grigio	new	321905	Grigio	new	321950	Grigio	new
321882	Antracite	new	162492	Antracite		158891	Antracite	
321639	Nero	new	186955	Nero		186979	Nero	new
321868	Coffee	new	321929	Coffee	new	321981	Coffee	new

4000 K
600 lm

151960 € 2,00

4000 K
600 lm

151960 € 2,00

4000 K
600 lm

151960 € 2,00



Cosmo

Corpo luce in resina resistente a corrosione, UV, a temperature da -60° a +90° C. Diffusore trasparente anti ingiallimento.

LED

Lampadine LED GX53 10W incluse.
CCT regolabile: 3000 K, 4000 K, 6500 K.



187877

187884

187891



IP55

2,150 Kg / 0,0220 m³
GX53 max 1x10W

€ 115

187877 Bianco
187884 Grigio
187891 Nero

154008 4000 K
1000 lm € 5,50



P. 808 P. 808 P. 855

Clio new

Articolo componibile con montatura in alluminio estruso e tornito, rifinito con vernici a polveri di colore antracite, bianco, grigio, nero e coffee. Diffusore in materiale plastico bianco opaco.



249469

249476

249452

249483

328829

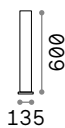

IP44

1,360 Kg / 0,0087 m³
E27 max 1x 42W

€ 84

- 249469 Bianco
- 249476 Grigio
- 249452 Antracite
- 249483 Nero
- 328829 Coffee new

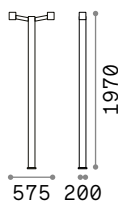

IP44

7,250 Kg / 0,0384 m³
E27 max 2x 42W

€ 250

- 249506 Bianco
- 249513 Grigio
- 249490 Antracite
- 249520 Nero
- 328836 Coffee new

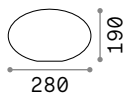

0,540 Kg / 0,0171 m³

€ 35

145068 Bianco

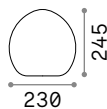

0,520 Kg / 0,0144 m³

€ 35

116716 Bianco

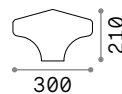

0,610 Kg / 0,0231 m³

€ 35

145020 Bianco

4000 K
600 lm
151960 € 2,00

4000 K
600 lm
151960 € 2,00



Cima

Corpo luce interamente in alluminio pressofuso. Con finitura antracite, coffee o nero e oro. Diffusore in acrilico trasparente.



246833

024097

246840

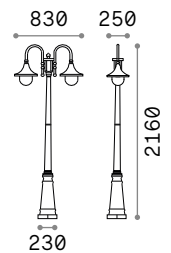

IP43

3,340 Kg / 0,1467 m³
E27 max 2 x 60W

€ 306

246833 ■ Antracite
024097 ■ Nero
246840 ■ Coffee

4000 K
980 lm
153964 € 6,00



P. 856



Dafne

Corpo luce in resina ad alte prestazioni: inattaccabile dalla corrosione, colori stabilizzati da trattamento U.V., resistente a sbalzi termici da -60° C a +90° C. Diffusore in metacrilato antingiallimento.

LED

Lampadine LED E27 8W Goccia incluse. CCT regolabile: 2700 K, 4000 K, 6500 K.



120454



101514



IP55

2,500 Kg / 0,0446 m³
E27 max 1x 23W

€ 85

120454 ■ Bianco
101514 ■ Nero

4000 K
980 lm

153964

€ 6,00



P. 857



Esterni

Proiettori

Indice alfabetico

Elio	918
Inside	922
Litio	919
Starlight	914
Terra	920
Thor	912
Ulex	916

Indice icone

new



Thor 912



Starlight 914



Ulex 916



Elio 918



Litio 919



Terra 920



Inside 922

Thor new

Proiettore lineare orientabile per installazione a superficie con effetto di luce radente. Corpo in alluminio pressofuso, diffusore in vetro trasparente. Sorgente luminosa a led integrato, disponibile in due lunghezze (500 mm e 1000 mm). Orientabilità +/-90° rispetto alla verticale, indice di protezione IP65, resistenza all'urto IK06, temperatura di colore 3000 K o 4000 K, ingresso di alimentazione 24 Vdc; durata utile LED 50.000 h. Disponibile in opzione con visiera anti-abbagliamento.

Sorgente	LED SMD	Durata LED	50.000 h
Potenza	18W / 40W	Classe	III
Driver incluso	No	isolamento	
Driver disponibili	On/Off	IP	65
MacAdam	SDCM 3	Materiale	Alluminio
CCT	3000 K/ 4000 K		
CRI	≥80		

PRO

Prodotto ad alto contenuto tecnologico, elevata qualità dei materiali, destinato ad uso professionale.

LED SMD OSRAM Driver non incluso

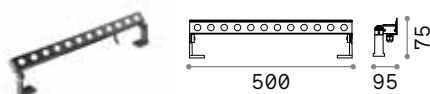

1,490 Kg/0,0057 m³
Lunghezza cavo 500 mm

Potenza	Angolo	Lumen	CCT	Finitura	Codice	€
20 W	28°	2300 lm	3000 K	Bianco	318523	215 <small>new</small>
				Antracite	261331	215
		2450 lm	4000 K	Bianco	322148	215 <small>new</small>
				Antracite	322131	215 <small>new</small>

LED SMD OSRAM Driver non incluso

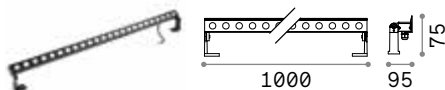

2,460 Kg/0,0108 m³
Lunghezza cavo 500 mm

Potenza	Angolo	Lumen	CCT	Finitura	Codice	€
40 W	28°	4500 lm	3000 K	Bianco	322117	325 <small>new</small>
				Antracite	261355	325
		4950 lm	4000 K	Bianco	322049	325 <small>new</small>
				Antracite	322018	325 <small>new</small>

OPTIONAL Non incluso



		Finitura	Codice	€
Visiera	18W	Bianco	318516	18 <small>new</small>
		Antracite	261362	18
	40W	Bianco	322162	29 <small>new</small>
		Antracite	261379	29

ON/OFF DRIVER Non incluso/Necessario

Potenza	Output	Misura	Codice	€
40 W	24 Vdc	171 x 37 x 61 mm	272108	100
100 W	24 Vdc	220 x 39 x 68 mm	226200	190
185 W	24 Vdc	220 x 39 x 68 mm	226217	210



Starlight

Proiettore orientabile in alluminio con fissaggio a plafone o con picchetto; superficie anodizzata e verniciata a polveri in grigio scuro; LED integrato ad efficienza energetica con elevata resa cromatica; disponibile in temperatura di colore 3000K e 4000K; durata utile LED 50.000 h. Visiera antiabbagliamento in opzione.

Sorgente	LED COB	Classe	III
Potenza	5,5W / 10W	isolamento	
Driver incluso	No	IP	68
Driver disponibili	On/Off	Materiale	Alluminio
CCT	3000 K / 4000 K		
CRI	≥80		
Durata LED	50.000 h		

PRO

Prodotto ad alto contenuto tecnologico, elevata qualità dei materiali, destinato ad uso professionale.

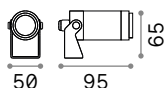

0,280 Kg/0,0005 m³

LED COB BRIDGELUX Driver non incluso

Potenza	Angolo	Lumen	CCT	Finitura	Codice	€
5,5 W	30°	600 lm	3000 K	Grigio Scuro	248394	120
		670 lm	4000 K	Grigio Scuro	245041	120

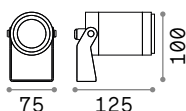

0,950 Kg/0,0014 m³

LED COB BRIDGELUX Driver non incluso

Potenza	Angolo	Lumen	CCT	Finitura	Codice	€
10 W	30°	1000 lm	3000 K	Grigio Scuro	248387	250
		1050 lm	4000 K	Grigio Scuro	245072	250

OPTIONAL Non incluso



	Potenza	Finitura	Codice	€
Visiera	5,5W	Grigio Scuro	245096	34
	10W	Grigio Scuro	245102	34
Connettore IP68		Nero	248615	22
Picchetto		Grigio Scuro	245089	17

ON/OFF DRIVER Non incluso/Necessario

Potenza	Output	Misura	Codice	€
20 W	24 Vdc	118 x 26 x 35 mm	226187	75
35 W	24 Vdc	148 x 30 x 40 mm	226194	80
100 W	24 Vdc	220 x 39 x 68 mm	226200	190
185 W	24 Vdc	220 x 39 x 68 mm	226217	210



Ulex

Proiettore orientabile per installazione a superficie, adatto per illuminazione generale o d'accento in esterni. Corpo in alluminio pressofuso, diffusore in vetro trasparente. Sorgente luminosa a led integrato, disponibile in due potenze. Indice di protezione IP65, resistenza all'urto IK06, temperatura di colore 3000K; durata utile LED 50.000 h. Disponibile in opzione con basetta di cablaggio, picchetto per installazione a terreno o visiera anti-abbagliamento.

Sorgente	LED SMD	Classe	I
Potenza	8,5W / 15W	isolamento	
Driver incluso	On/Off	IP	65
Driver disponibili	No	Materiale	Alluminio
CCT	3000 K		
CRI	≥80		
Durata LED	50.000 h		

PRO Prodotto ad alto contenuto tecnologico, elevata qualità dei materiali, destinato ad uso professionale.

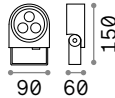

0,660 Kg/0,0025 m³
Lunghezza cavo 2000 mm

LED SMD OSRAM Driver ON/OFF incluso

Potenza	Angolo	Lumen	CCT	Finitura	Codice	€
8,5 W	30°	640 lm	3000 K	Antracite	261287	145

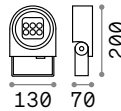

1,190 Kg/0,0042 m³
Lunghezza cavo 2000 mm

LED SMD OSRAM Driver ON/OFF incluso

Potenza	Angolo	Lumen	CCT	Finitura	Codice	€
15 W	30°	1280 lm	3000 K	Antracite	261294	220

OPTIONAL Non incluso



		Finitura	Codice	€
Box	8,5 W	Antracite	268156	32
	15 W	Antracite	268187	49



		Finitura	Codice	€
Picchetto	8,5 W	Antracite	268163	14
	15 W	Antracite	268194	17



		Finitura	Codice	€
Visiera	8,5 W	Antracite	268170	17
	15 W	Antracite	268200	25





Elio

Corpo luce e diffusore in resina ad alte prestazioni: inattaccabile dalla corrosione sia di agenti atmosferici che di fertilizzanti chimici, colori stabilizzati da trattamento U.V., resistente a sbalzi termici da -60° C a + 90° C. Diffusore direzionabile.

LED Lampadine LED GU10 3,5W incluse. CCT regolabile: 2700 K, 4000 K.

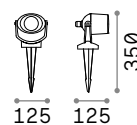

IP66  INCLUSE

0,360 Kg / 0,0027 m³
GU10 max 1x6W

€ 82

120218 ■ Bianco
120201 ■ Nero

 4000 K
430 lm
253497 € 3,00



Litio

Corpo luce e diffusore in resina ad alte prestazioni: inattaccabile dalla corrosione sia di agenti atmosferici che di fertilizzanti chimici, colori stabilizzati da trattamento U.V., resistente a sbalzi termici da -60° C a + 90° C. Diffusore direzionabile.

LED

Lampadine LED GX53 10W incluse.
CCT regolabile: 3000 K, 4000 K,
6500 K.



145310



145334



145358

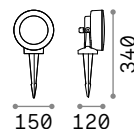

IP66

0,730 Kg / 0,0044 m³
GX53 max 1x10W

€ 90

145310 ■ Bianco
145334 ■ Grigio
145358 ■ Nero

4000 K
1000 lm

154008 € 5,50



P. 823



Terra ^{new}

Montatura in fusione d'alluminio verniciata. Corpo luce posizionabile. Diffusore in vetro pirex trasparente.

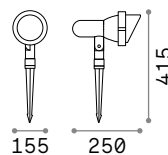

IP65

1,230 Kg / 0,0086 m³
E27 max 1x42W

€ 90

033044 ■ Antracite
321622 ■ Coffee ^{new}

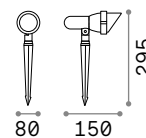

IP65

0,520 Kg / 0,0038 m³
GU10 max 1x28W

€ 52

106205 ■ Bianco
033037 ■ Antracite
046211 ■ Nero
163727 ■ Coffee

4000 K
600 lm
151960 € 2,00

4000 K
430 lm
253497 € 3,00



Inside

Montatura in fusione d'alluminio verniciato a polveri con finitura antracite, coffee o grigio. Corpo luce posizionabile. Diffusore in vetro pirex trasparente. Dotato di lancia da interrare.

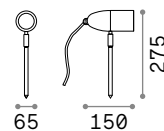

IP54

0,370 Kg / 0,0015 m³
G9 max 1x 15W

€ 36

115412 ■ Antracite
115429 ■ Nero
247045 ■ Coffee

4000 K
530 lm

307879 € 6,00



Esterni

Incassi

Indice alfabetico

Avenue	929
Bit	926
Floor	936
Gravity	939
Indio	928
Landing	940
Park	938
Rocket	942
Rocket Mini	943
Taurus	930
Way	941
Wire	927

Indice icone



Bit 926



Wire 927



Indio 928



Avenue Square 929



Avenue Round 929



Taurus Round 930



Taurus Square 930



Floor 936



Park Round 938



Park Square 938



Gravity Round 939



Gravity Square 939



Landing 940



Way 941



Way 941



Way 941



Rocket 942



Rocket 942



Rocket Mini 943



Rocket Mini 943



Rocket Mini 943



Bit

Corpo luce da incasso in alluminio pressofuso verniciato a polveri. Diffusore in vetro temperato trasparente. Disponibile nelle finiture antracite o bianco.

LED Sorgente luminosa LED 3000 K, 35.000 h di durata.

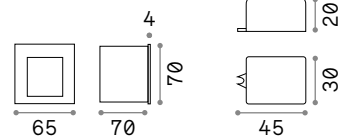

IP65

0,300 Kg / 0,0006 m³
LED 2W / 340 lm

€ 55

269023 ■ Bianco
269009 ■ Antracite

Driver
Non incluso
Necessario

€ 12

276205



Wire

Corpo luce da incasso in alluminio pressofuso verniciato a polveri. Diffusore in vetro temperato trasparente. Disponibile nelle finiture antracite o bianco.

LED Sorgente luminosa LED 3000 K, 20.000 h di durata.



255521

268996

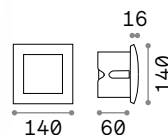

IP65

0,460 Kg / 0,0018 m³
LED 4W / 200 lm

€ 56

268989 ■ Bianco
255514 ■ Antracite

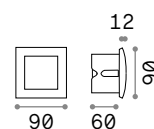

IP65

0,220 Kg / 0,0009 m³
LED 1,5W / 55 lm

€ 38

268996 ■ Bianco
255521 ■ Antracite



Indio

Corpo luce a incasso in alluminio pressofuso verniciato a polveri. Diffusore in vetro temperato serigrafato in bianco.

LED Sorgente luminosa LED 3000 K, 35.000 h di durata.

190	105
70	70
85	80
1,090 Kg / 0,0023 m ³ LED 8W / 960 lm	0,540 Kg / 0,0011 m ³ LED 5W / 440 lm
€ 144	€ 95
255804 Bianco	255781 Bianco



Avenue

Corpo luce e diffusore in resina ad alte prestazioni: inattaccabile dalla corrosione sia di agenti atmosferici che di fertilizzanti chimici, colori stabilizzati da trattamento U.V., resistente a sbalzi termici da -60° C a + 90° C.

LED Lampadine LED GX53 3W incluse.
CCT regolabile: 3000 K, 4000 K, 6500 K.



096575



096599



096582

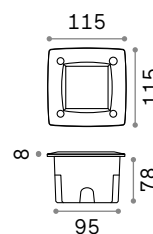
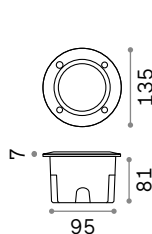

0,400 Kg / 0,0025 m³
GX53 max 1x9W

0,400 Kg / 0,0025 m³
GX53 max 1x9W

€ 37

€ 37

096544 ■ Bianco
096568 ■ Grigio
096551 ■ Nero

096575 ■ Bianco
096599 ■ Grigio
096582 ■ Nero

4000 K
1000 lm

154008 € 5,50

4000 K
1000 lm

154008 € 5,50

Taurus ^{new}

Proiettore da incasso per installazione a pavimento, parete o soffitto. Corpo in alluminio pressofuso, ghiera rotonda o quadrata in acciaio inox 316L, diffusore in vetro. Sorgente luminosa a LED integrato; disponibile nelle versioni ACCENT con 1, 2 o 3 moduli singolarmente orientabili di +/- 30° mediante perno esterno per ampliare, restringere o direzionare il fascio luminoso complessivo; oppure nelle versioni WIDE non orientabili per un'illuminazione diffusa e uniforme. Calpestabile, indice di protezione IP67, resistenza all'urto IK10, temperatura di colore 3000K CRI ≥ 80.

S316 Articolo in acciaio inox 316.

Sorgente	LED SMD
Potenza	6W / 21W
Driver incluso	On/Off
Driver disponibili	No
CCT	3000 K
CRI	≥80
Durata LED	50.000 h
Classe isolamento	I
IP	67
Materiale	Alluminio





Taurus Accent



LED SMD OSRAM Driver ON/OFF incluso

Dimensioni	Peso	Volume	Potenza	Lumen	CCT	Finitura		Codice	€
ø 100	1,460 Kg	0,0129 m³	6 W	420 lm	3000 K	Acciaio		277004	210
ø 135	1,980 Kg	0,0071 m³	11 W	840 lm	3000 K	Acciaio		277011	320
ø 170	3,250 Kg	0,0133 m³	14 W	1300 lm	3000 K	Acciaio		277028	405
ø 210	3,500 Kg	0,0242 m³	20 W	1900 lm	3000 K	Acciaio		277035	530

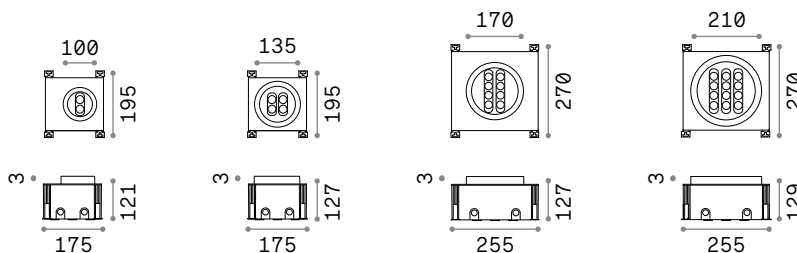

LED SMD OSRAM Driver ON/OFF incluso



Dimensioni	Peso	Volume	Potenza	Lumen	CCT	Finitura		Codice	€
100	1,100 Kg	0,0067 m³	6 W	420 lm	3000 K	Acciaio		325620	235 <i>new</i>
135	1,700 Kg	0,0080 m³	11 W	840 lm	3000 K	Acciaio		325651	355 <i>new</i>
170	2,050 Kg	0,0141 m³	14 W	1300 lm	3000 K	Acciaio		325682	435 <i>new</i>
210	3,000 Kg	0,0168 m³	20 W	1900 lm	3000 K	Acciaio		325712	575 <i>new</i>

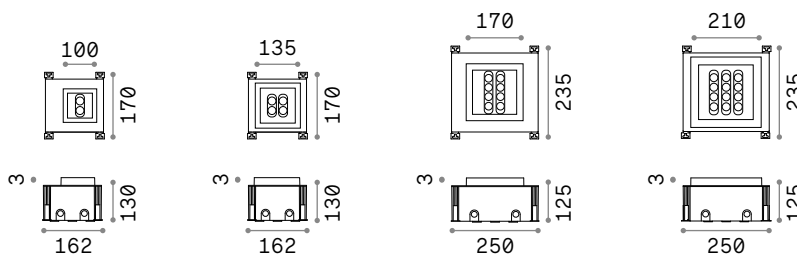



Taurus Wide



LED SMD BRIDGELUX Driver ON/OFF incluso

Dimensioni	Peso	Volume	Potenza	Lumen	CCT	Finitura		Codice	€
ø100	1,100 Kg	0,0077 m³	6 W	620 lm	3000 K	Acciaio		325637	195 <small>new</small>
ø135	1,400 Kg	0,0091 m³	11 W	1250 lm	3000 K	Acciaio		325668	275 <small>new</small>
ø170	2,100 Kg	0,0137 m³	16 W	1750 lm	3000 K	Acciaio		325699	320 <small>new</small>
ø210	3,000 Kg	0,0183 m³	20 W	2700 lm	3000 K	Acciaio		325729	420 <small>new</small>

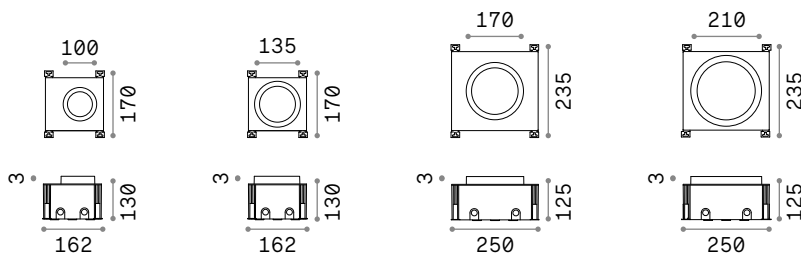

LED SMD BRIDGELUX Driver ON/OFF incluso



Dimensioni	Peso	Volume	Potenza	Lumen	CCT	Finitura		Codice	€
100	1,100 Kg	0,0067 m³	6 W	620 lm	3000 K	Acciaio		325644	205 <small>new</small>
135	1,580 Kg	0,0080 m³	11 W	1250 lm	3000 K	Acciaio		325675	285 <small>new</small>
170	2,380 Kg	0,0141 m³	16 W	1750 lm	3000 K	Acciaio		325705	340 <small>new</small>
210	3,000 Kg	0,0168 m³	20 W	2700 lm	3000 K	Acciaio		325736	450 <small>new</small>

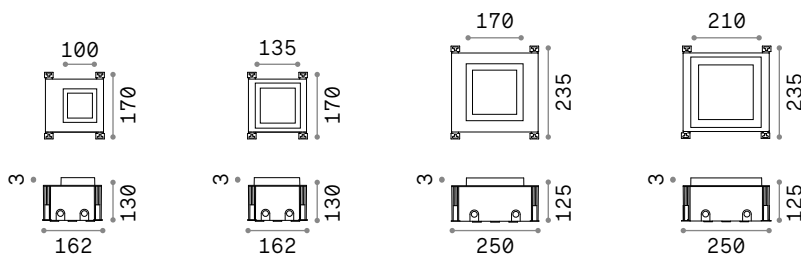









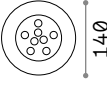
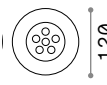

Floor

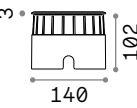
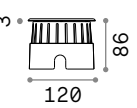
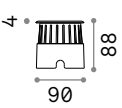
Incasso fisso da esterni in alluminio pressofuso con ghiera rotonda disponibile in tre dimensioni, adatto per installazione a terra e a pavimento. Finitura in alluminio anodizzato con diffusore in vetro temprato extrachiario. LED integrati raffreddati passivamente con ottica di 30°; disponibile in temperatura di colore 3000 K e CRI ≥ 80; grado di protezione IP 67; IK 10.

LED Sorgente luminosa LED 3000 K, 25.000 h di durata.

		
		
		
0,960 Kg / 0,0049 m³ LED 12W / 1340 Lm	0,640 Kg / 0,0015 m³ LED 6W / 680 Lm	0,390 Kg / 0,0010 m³ LED 3W / 310 Lm
€ 106	€ 73	€ 55
255682 ■ Acciaio	255668 ■ Acciaio	255651 ■ Acciaio





Park

Spot da incasso. Corpo luce esterno in PVC. Parabola riflettente in alluminio. Cornice blocca vetro in acciaio satinato. Vetro trasparente.

1,210 Kg / 0,0066 m ³ E27 max 1x60W	0,580 Kg / 0,0032 m ³ GU10 max 1x20W	0,900 Kg / 0,0032 m ³ G9 max 1x15W
€ 80	€ 57	€ 80
032825 Acciaio	032832 Acciaio	117881 Acciaio
4000 K 980 lm	4000 K 430 lm	4000 K 530 lm
153964 € 6,00	253497 € 3,00	307879 € 6,00



Gravity

Corpo luce e diffusore in resina ad alte prestazioni: inattaccabile dalla corrosione sia di agenti atmosferici che di fertilizzanti chimici, colori stabilizzati da trattamento U.V., resistente a sbalzi termici da -60° C a + 90° C. Carrabile fino a 5000 Kg.

LED Lampadine LED GU10 3,5W e LED GX53 10W incluse. CCT regolabile.

<p>IP67 </p> <p>0,670 Kg / 0,0043 m³ GX53 max 1x 10W</p> <p>€ 85</p> <p>120324 ■ Nero</p>	<p>IP67 </p> <p>0,270 Kg / 0,0019 m³ GU10 max 1x 6W</p> <p>€ 58</p> <p>120249 ■ Nero</p>	<p>IP67 </p> <p>0,700 Kg / 0,0043 m³ GX53 max 1x 10W</p> <p>€ 85</p> <p>120386 ■ Nero</p>	<p>IP67 </p> <p>0,270 Kg / 0,0019 m³ GU10 max 1x 6W</p> <p>€ 58</p> <p>120317 ■ Nero</p>
<p>4000 K 1000 lm</p> <p>154008 € 5,50</p>	<p>4000 K 430 lm</p> <p>253497 € 3,00</p>	<p>4000 K 1000 lm</p> <p>154008 € 5,50</p>	<p>4000 K 430 lm</p> <p>253497 € 3,00</p>



Landing

Corpo luce e diffusore in resina ad alte prestazioni: inattaccabile dalla corrosione sia di agenti atmosferici che di fertilizzanti chimici, colori stabilizzati da trattamento U.V., resistente a sbalzi termici da -60° C a + 90° C. Carrabile fino a 5000 Kg.

LED Lampadine LED GU10 3,5W e LED GX53 10W incluse. CCT regolabile.



120362



120287

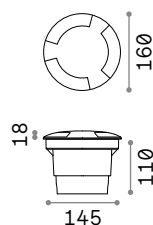

0,740 Kg / 0,0043 m³
GX53 max 1x 10W

€ 125

120362 ■ Nero

4000 K
1000 lm

154008 € 5,50

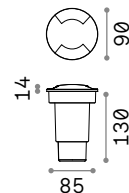

0,260 Kg / 0,0020 m³
GU10 max 1x 6W

€ 85

120287 ■ Nero

4000 K
430 lm

253497 € 3,00

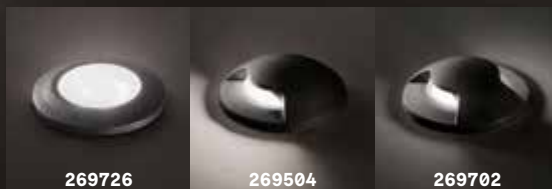

Way

Apparecchio da incasso calpestabile. Corpo luce e diffusore in resina ad alte prestazioni: anti corrosione, anti U.V., da -60°a +90° C. Colore: nero.

LED

Lampadine LED G9 2W 3000/4000 K incluse. Cod. **270104/270111**

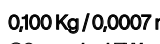
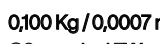
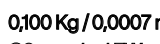
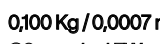
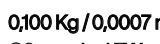
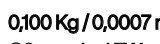
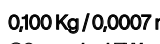
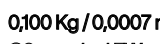
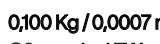
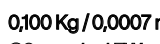
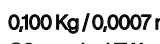
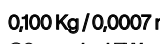
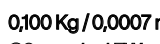
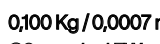
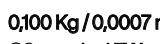
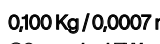
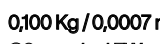
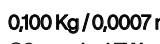
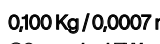
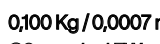
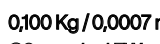
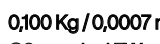
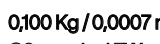
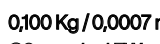
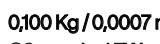
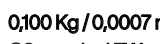
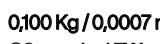
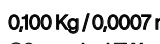
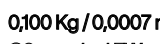
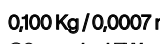
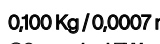
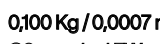
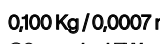
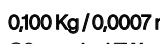
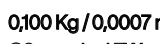
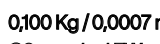
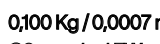
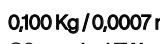
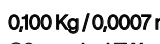
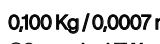
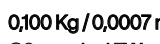
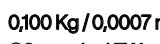
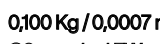
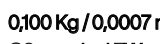
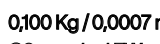
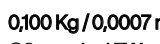
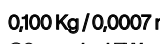
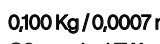
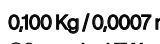
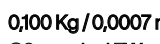
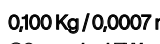
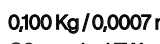
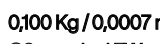
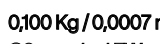
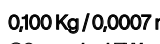
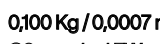
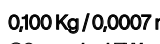
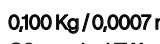
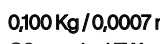
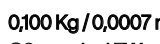
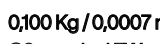
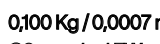
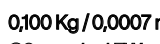
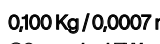
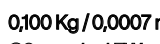
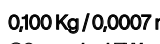
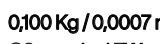
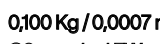
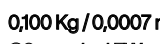
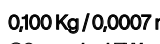
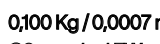
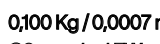
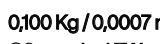
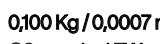
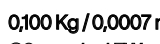
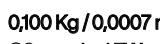
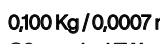
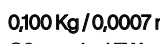
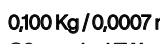
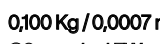
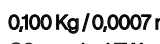
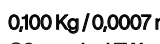
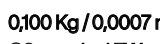
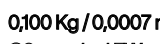
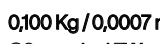
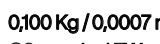
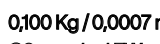
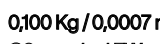
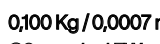
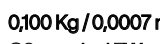
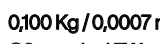
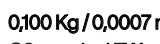
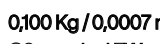
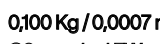
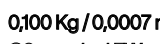
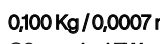
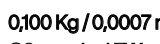
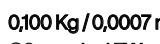
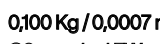
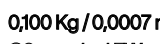
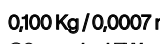
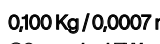
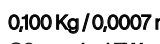
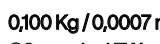
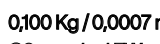
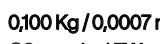
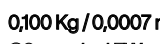
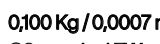
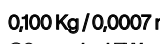
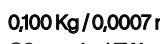
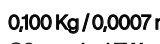
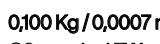
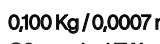
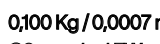
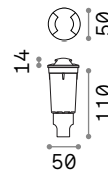
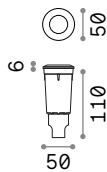



Rocket

Apparecchio da incasso calpestabile. Corpo luce in acciaio spazzolato. Diffusore in vetro temperato.

LED Sorgente luminosa LED 3000/4000 K, 30.000 h di durata.

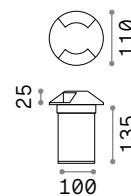
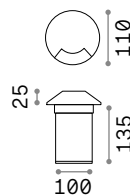

IP65

IP65

0,560 Kg / 0,0034 m³
LED 3,5W / 230/270 lm

0,560 Kg / 0,0034 m³
LED 3,5W / 230/270 lm

€ 135

€ 135

247144	Acciaio	3000K	247151	Acciaio	3000K
122014	Acciaio	4000K	122021	Acciaio	4000K



Rocket Mini

Diffusore in vetro temperato trasparente. Calpestabile. Sorgente luminosa a led integrato. Assenza di viti a vista. Disponibile nelle versioni a 1, 2 luci in radenza pavimento oppure con unica luce centrale d'accento.

LED Sorgente luminosa LED 4000 K, 50.000 h di durata.

IP68 Grado di protezione IP68.

S316 Articolo in acciaio inox 316.

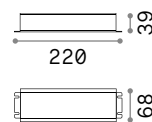
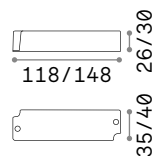
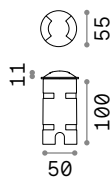
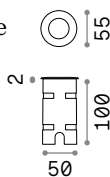

IP68

IP68

0,280 Kg / 0,0008 m³
LED 2W / 210 lm

0,330 Kg / 0,0008 m³
LED 2W / 210 lm

Driver
Non incluso
Necessario

Driver
Non incluso
Necessario

€ 100

€ 130 / 150

€ 75 / 80

€ 190 / 210

212623 ■ Acciaio 15°
212647 ■ Acciaio 40°

222820 ■ Acciaio
222837 ■ Acciaio

226187 20W
226194 35W

226200 100W
226217 185W



Lampadine* e accessori

new



E14 946



E27 948



G4 954



G9 954



GX53 955



R7s 955



GU10 956



Kit Emergency 957

new

new



Ceiling Cups 958



Bulb Holders 960



Cables 960



Cables Holders 960

* Per le lampadine e strip led al prezzo indicato non sono applicabili ulteriori promozioni.



Lampadine E14

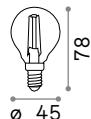

Lamp socket	Power	Flux	CCT	CRI	Dimmable	Life	Min Qty.	Code	€
E14	4W	480lm	3000K	80		25.000 h	10	101200	2,50
E14	4W	380lm	3000K	80	TRIAC	15.000 h	10	188935	3,50
E14	4W	520lm	4000K	80		25.000 h	10	153926	2,50
E14	4W	420lm	3000K	90		25.000 h	10	271620	2,50

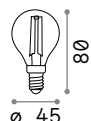

E14	4W	300lm	2200K	80		15.000 h	10	151656	4,60
-----	----	-------	-------	----	--	----------	----	--------	------

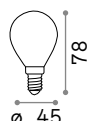

E14	4W	420lm	3000K	80		25.000 h	10	101217	2,50
E14	4W	340lm	3000K	80	TRIAC	25.000 h	10	289229	3,50
E14	4W	470lm	4000K	80		25.000 h	10	253411	2,50
E14	4W	340lm	3000K	90		25.000 h	10	289212	2,50

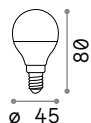

E14	6W	600lm	3000K	80		25.000 h	10	151731	2,50
E14	6W	630lm	4000K	80		25.000 h	10	151946	2,50

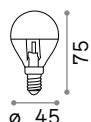

E14	4W	370lm	3000K	80		25.000 h	10	101262	3,70
-----	----	-------	-------	----	--	----------	----	--------	------

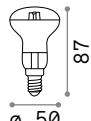

E14	4W	300lm	3000K	80		25.000 h	10	101255	3,70
-----	----	-------	-------	----	--	----------	----	--------	------

Lamp socket	Power	Flux	CCT	CRI	Dimmable	Life	Min Qty.	Code	€
-------------	-------	------	-----	-----	----------	------	----------	------	---

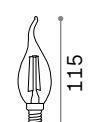

E14	4W	430lm	3000K	80		25.000 h	10	101248	2,50
E14	4W	420lm	3000K	80	TRIAC	15.000 h	10	188911	3,50
E14	4W	460lm	4000K	80		25.000 h	10	153940	2,50

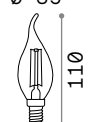

E14	4W	400lm	2200K	80		15.000 h	10	151663	4,60
-----	----	-------	-------	----	--	----------	----	--------	------

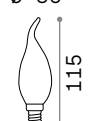

E14	4W	380lm	3000K	80		25.000 h	10	151793	2,50
-----	----	-------	-------	----	--	----------	----	--------	------

Lampadine E14

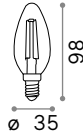

Lamp socket	Power	Flux	CCT	CRI	Dimmable	Life	Min Qty.	Code	€
E14	4W	450 lm	2700 K	80		25.000 h	10	270944	2,50
E14	4W	470 lm	3000 K	80		25.000 h	10	101224	2,50
E14	4W	320 lm	3000 K	80	TRIAC	15.000 h	10	188928	3,50
E14	4W	490 lm	4000 K	80		25.000 h	10	153933	2,50
E14	4W	430 lm	3000 K	90		25.000 h	10	271644	2,50

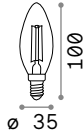

E14	4W	370 lm	2200 K	80		15.000 h	10	151649	4,60
-----	----	--------	--------	----	--	----------	----	--------	------

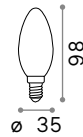

E14	4W	370 lm	3000 K	80		25.000 h	10	101231	2,50
-----	----	--------	--------	----	--	----------	----	--------	------

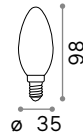

E14	4W	430 lm	3000 K	80		15.000 h	10	326610	4,50 new
-----	----	--------	--------	----	--	----------	----	--------	---

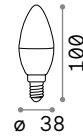

E14	6W	520 lm	3000 K	80		25.000 h	10	151748	2,50
E14	6W	540 lm	4000 K	80		25.000 h	10	151953	2,50



151663



151793



101224



151649



101231



326610



101200



101262

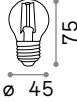

Lampadine E27

		Lamp socket	Power	Flux	CCT	CRI	Dimmable	Life	Min Qty.	Code	€
		E27	4 W	420 lm	2700 K	80		25.000 h	10	271637	2,60
		E27	4 W	430 lm	3000 K	80		25.000 h	10	101279	2,60
		E27	4 W	340 lm	3000 K	80	TRIAC	15.000 h	10	188942	3,50
		E27	4 W	490 lm	4000 K	80		25.000 h	10	153957	2,60
		E27	4 W	350 lm	3000 K	90		25.000 h	10	289236	2,60
		E27	4 W	380 lm	2200 K	80		15.000 h	10	151861	4,60
		E27	4 W	340 lm	3000 K	80		25.000 h	10	101286	2,60
		E27	6 W	600 lm	3000 K	80		25.000 h	10	151755	2,00
		E27	6 W	630 lm	4000 K	80		25.000 h	10	151960	2,00
		E27	4 W	480 lm	3000 K	80		25.000 h	10	101293	2,60
		E27	4 W	520 lm	4000 K	80		25.000 h	10	253428	2,60
		E27	8 W	930 lm	2700 K	80		25.000 h	10	270951	6,00
		E27	8 W	910 lm	3000 K	80		25.000 h	10	119571	6,00
		E27	8 W	680 lm	3000 K	80	TRIAC	15.000 h	10	188973	7,00
		E27	8 W	980 lm	4000 K	80		25.000 h	10	153964	6,00
		E27	8 W	880 lm	3000 K	90		25.000 h	10	271613	6,00
		E27	10 W	1300 lm	3000 K	80		25.000 h	10	256528	7,00
		E27	10 W	1380 lm	4000 K	80		25.000 h	10	270920	7,00
		E27	4 W	370 lm	2200 K	80		15.000 h	10	151687	4,60
		E27	8 W	900 lm	3000 K	80		25.000 h	10	123899	6,00
		E27	8 W	860 lm	3000 K	80	TRIAC	25.000 h	10	252209	7,00
		E27	8 W	1030 lm	4000 K	80		25.000 h	10	253459	6,00
		E27	8 W	780 lm	3000 K	90		25.000 h	10	289250	7,00
		E27	10 W	1000 lm	3000 K	80		25.000 h	10	151762	2,00
		E27	10 W	1050 lm	4000 K	80		25.000 h	10	151991	2,00
		E27	8 W	920 lm	3000 K	80		25.000 h	10	305622	7,00
		E27	10 W	1200 lm	3000 K	80		25.000 h	10	305639	7,00

Lampadine E27

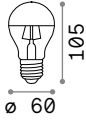

Lamp socket	Power	Flux	CCT	CRI	Dimmable	Life	Min Qty.	Code	€
E27	8 W	770 lm	3000 K	80		25.000 h	10	123882	7,00

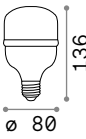

Lamp socket	Power	Flux	CCT	CRI	Dimmable	Life	Min Qty.	Code	€
E27	20 W	2000 lm	3000 K	80		25.000 h	1	296197	5,00
E27	20 W	2050 lm	4000 K	80		25.000 h	1	306889	5,00



E27	30 W	3100 lm	3000 K	80		25.000 h	1	296210	9,50
E27	30 W	3200 lm	4000 K	80		25.000 h	1	306896	9,50



296197



296210



101279



151861















123899



305622



Lampadine E27

	Lamp socket	Power	Flux	CCT	CRI	Dimmable	Life	Min Qty.	Code	€
	E27	8 W	1050 lm	3000 K	80		25.000 h	10	101323	7,00
	E27	8 W	680 lm	3000 K	80	TRIAC	15.000 h	10	188966	8,00
	E27	8 W	1120 lm	4000 K	80		25.000 h	10	153971	7,00
	E27	8 W	860 lm	3000 K	90		25.000 h	10	271606	7,00
	E27	4 W	500 lm	2200 K	80		15.000 h	10	151717	8,00
	E27	4 W	330 lm	2200 K	80	TRIAC	15.000 h	10	223933	8,00
	E27	8 W	950 lm	3000 K	80		25.000 h	10	101330	7,50
	E27	8 W	860 lm	3000 K	80	TRIAC	25.000 h	10	252186	7,50
	E27	8 W	1050 lm	4000 K	80		25.000 h	10	253442	7,50
	E27	8 W	770 lm	3000 K	90		25.000 h	10	289243	7,50
	E27	15 W	1820 lm	3000 K	80		25.000 h	10	151779	4,60
	E27	15 W	1890 lm	4000 K	80		25.000 h	10	151977	4,60
	E27	8 W	900 lm	3000 K	80	TRIAC	15.000 h	10	277790	10,00
	E27	8 W	1050 lm	3000 K	80		25.000 h	10	157597	10,00
	E27	9 W	930 lm	3000 K	80		25.000 h	10	135526	10,00



101330



277790



157597



135526

Lampadine E27



Lamp socket	Power	Flux	CCT	CRI	Dimmable	Life	Min Qty.	Code	€
E27	8 W	1050lm	3000 K	80		25.000 h	10	101347	8,00
E27	8 W	680 lm	3000 K	80	TRIAC	15.000 h	10	188959	8,00
E27	8 W	1120 lm	4000 K	80		25.000 h	10	153988	8,00
E27	8 W	860 lm	3000 K	90		25.000 h	10	271590	8,00
E27	4 W	480 lm	2200 K	80		15.000 h	10	151724	8,00
E27	4 W	330 lm	2200 K	80	TRIAC	15.000 h	10	223926	8,00
E27	8 W	950 lm	3000 K	80		25.000 h	10	101354	8,00
E27	8 W	1050 lm	4000 K	80		25.000 h	10	253435	8,00
E27	18 W	2180lm	3000 K	80		25.000 h	10	151786	7,50
E27	18 W	2280lm	4000 K	80		25.000 h	10	152004	7,50
E27	8 W	900 lm	3000 K	80	TRIAC	15.000 h	10	277813	9,50
E27	8 W	1050 lm	3000 K	80		25.000 h	10	157580	9,50



101347



151724



101354



277813



Lampadine E27

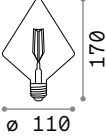
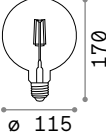
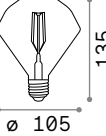
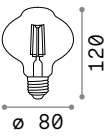
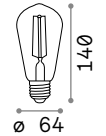
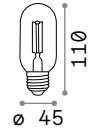

Lamp socket	Power	Flux	CCT	CRI	Dimmable	Life	Min Qty.	Code	€
E27	4 W	330 lm	2200 K	80		15.000 h	10	151700	4,60
E27	4 W	440 lm	2200 K	80		15.000 h	10	151694	6,00
E27	4 W	330 lm	2200 K	80	TRIAC	15.000 h	10	223919	6,00
E27	4 W	360 lm	1800 K	80		15.000 h	10	201283	5,00
E27	4 W	360 lm	1800 K	80		15.000 h	10	201269	9,50
E27	4 W	360 lm	1800 K	80		15.000 h	10	201290	11,50
E27	4 W	360 lm	1800 K	80		15.000 h	10	201276	11,50



151700

151694

201283

201269

201290

201276

Lampadine E27

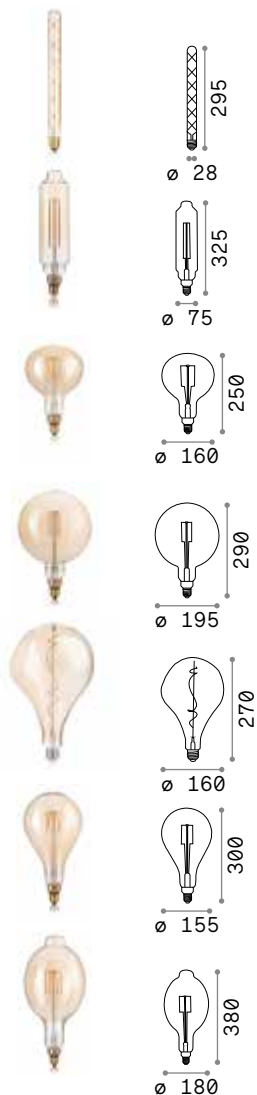

Lamp socket	Power	Flux	CCT	CRI	Dimmable	Life	Min Qty.	Code	€
E27	6 W	500 lm	2200 K	80		15.000 h	10	201252	9,50
E27	4 W	320 lm	2200 K	80		15.000 h	1	130170	30,00
E27	4 W	340 lm	1800 K	80		15.000 h	1	129877	33,00
E27	4 W	330 lm	2200 K	80	TRIAC	15.000 h	1	223940	33,00
E27	4 W	400 lm	2200 K	80		25.000 h	1	130187	25,00
E27	4 W	330 lm	2200 K	80	TRIAC	15.000 h	1	223834	30,00
E27	4 W	360 lm	2200 K	80		25.000 h	1	237251	22,50
E27	8 W	700 lm	2200 K	80		25.000 h	1	130163	25,00
E27	4 W	320 lm	2200 K	80		15.000 h	1	129860	30,00



Lampadine G4

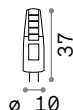
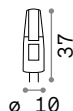

Lamp socket	Power	Flux	CCT	CRI	Dimmable	Life	Min Qty.	Code	€
G4	1,5 W	160 lm	3000 K	80		15.000 h	20	188980	4,50
G4	1,5 W	150 lm	3000 K	90		15.000 h	20	288345	4,50
G4	2 W	200 lm	3000 K	80		20.000 h	20	222257	4,00
G4	2 W	180 lm	3000 K	80	Phase-cut	25.000 h	20	266282	5,00

Lampadine G9

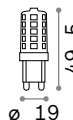
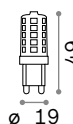
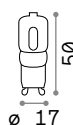

Lamp socket	Power	Flux	CCT	CRI	Dimmable	Life	Min Qty.	Code	€
G9	2 W	150 lm	3000 K	80		25.000 h	20	270104	8,50
G9	2 W	160 lm	4000 K	80		25.000 h	20	270111	8,50
G9	2,5 W	200 lm	3000 K	80		20.000 h	20	122168	3,50
G9	2,5 W	210 lm	4000 K	80		20.000 h	20	253381	3,50
G9	3 W	350 lm	2700 K	80		15.000 h	20	270968	3,90
G9	3 W	370 lm	3000 K	80		15.000 h	20	209043	3,90
G9	3 W	260 lm	3000 K	80	TRIAC	25.000 h	20	288215	5,50
G9	3 W	390 lm	4000 K	80		15.000 h	20	209036	3,90
G9	3,5 W	310 lm	3000 K	90		15.000 h	20	288208	3,90
G9	4 W	510 lm	3000 K	80		15.000 h	20	305486	6,00
G9	3,5 W	420 lm	3000 K	80	TRIAC	15.000 h	20	305431	8,50
G9	4 W	530 lm	4000 K	80		15.000 h	20	307879	6,00
G9	4 W	440 lm	4000 K	80	TRIAC	15.000 h	20	307886	8,50

Lampadine GX53

101385

123936

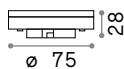

Lamp socket	Power	Flux	CCT	CRI	Dimmable	Life	Min Qty.	Code	€
GX53	7W	730 lm	3000 K	80		25.000 h	10	101385	5,50
GX53	7W	760 lm	4000 K	80		25.000 h	10	253404	5,50
GX53	9W	910 lm	3000 K	80		25.000 h	10	123936	5,50
GX53	9W	890 lm	3000 K	80	TRIAC	25.000 h	10	252551	9,00
GX53	9W	1000 lm	4000 K	80		25.000 h	10	154008	5,50
GX53	9W	900 lm	4000 K	80	TRIAC	25.000 h	10	252568	9,00
GX53	9W	940 lm	3000 K	90		25.000 h	10	288383	5,50

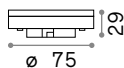

Lampadine R7s

189109

307862

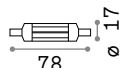

Lamp socket	Power	Flux	CCT	CRI	Dimmable	Life	Min Qty.	Code	€
R7s	7W	560 lm	3000 K	80		20.000 h	10	189109	13,50
R7s	6W	450 lm	3000 K	80	TRIAC	20.000 h	10	266770	15,00
R7s	7W	580 lm	4000 K	80		20.000 h	10	272375	13,50
R7s	6W	480 lm	4000 K	80	TRIAC	20.000 h	10	272382	15,00
R7s	13W	760 lm	3000 K	80		20.000 h	10	189093	17,50
R7s	8W	580 lm	3000 K	80	TRIAC	20.000 h	10	266763	19,00
R7s	13W	830 lm	4000 K	80		20.000 h	10	253480	17,50
R7s	8W	640 lm	4000 K	80	TRIAC	20.000 h	10	266756	19,00
R7s	14W	1700 lm	3000 K	80		15.000 h	10	307862	12,00
R7s	14W	1600 lm	3000 K	80	TRIAC	15.000 h	10	307855	13,50
R7s	14W	1750 lm	4000 K	80		15.000 h	10	296869	12,00
R7s	14W	1650 lm	4000 K	80	TRIAC	15.000 h	10	296876	13,50

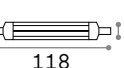

Lampadine GU10

Lamp socket	Power	Flux	CCT	CRI	Beam	Dimm.	Life	Min Qty.	Code	€
GU10	5W	410 lm	3000 K	90	50°		25.000 h	10	108292	3,00
GU10	5W	430 lm	4000 K	90	50°		25.000 h	10	253497	3,00
GU10	6W	430 lm	3000 K	90	47°	TRIAC	25.000 h	10	266251	4,50
GU10	6W	450 lm	4000 K	90	47°	TRIAC	25.000 h	10	285566	4,50
GU10	7W	540 lm	3000 K	90	50°		25.000 h	10	123943	3,50
GU10	7W	460 lm	3000 K	90	50°	TRIAC	25.000 h	10	288239	5,00



GU10	7W	620 lm	3000 K	90	108°		25.000 h	10	101378	4,50
GU10	7W	650 lm	4000 K	90	108°		30.000 h	10	117652	4,50

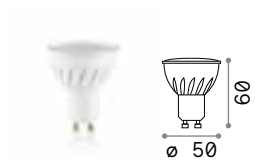

GU10	8W	580 lm	3000 K	90	50°		25.000 h	10	189062	4,50
GU10	8W	620 lm	4000 K	90	50°		25.000 h	10	270975	4,50



GU10	5W	380 lm	2700 K	95	50°		25.000 h	10	307619	3,00
GU10	7W	540 lm	4000 K	90	50°		25.000 h	10	224367	3,50



GU10	7W	600 lm	2700 K	95	108°		25.000 h	10	307626	3,50
------	----	--------	--------	----	------	--	----------	----	--------	------



108292



101378

189062

307619

307626

Lampadine GU10

	Lamp socket	Power	Flux	CCT	CRI	Beam	Dimm.	Life	Min Qty.	Code	€
	GU10	12 W	960 lm	3000 K	80	23°		25.000 h	10	242040	13,50
	GU10	12 W	900 lm	3000 K	80	23°	TRIAC	25.000 h	10	266305	15,00
	GU10	12 W	1190 lm	4000 K	80	23°		25.000 h	10	285573	14,00
	GU10	12 W	1120 lm	3000 K	80	46°		25.000 h	10	183794	13,50
	GU10	12 W	1240 lm	4000 K	80	46°		25.000 h	10	253466	14,00
	GU10	13 W	1300 lm	3000 K	80	46°	TRIAC	25.000 h	10	266299	18,00
	GU10	10 W	800 lm	3000 K	80	20°		15.000 h	10	189031	15,00
	GU10	10 W	820 lm	4000 K	80	20°		15.000 h	10	253398	15,00
	GU10	10 W	800 lm	3000 K	80	24°	TRIAC	15.000 h	10	288543	18,00



242040



183794



189031

Kit emergency

Kit luce d'emergenza per moduli LED. Include inverter e batteria. Autonomia da due a tre ore con un tempo di ricarica rispettivamente di 12 e 24 ore. Funzionamento in sola emergenza o in luce continua (luce continua in abbinamento con alimentatori elettronici e alimentatori elettronici dimmerabili). Protetto in classe II.

€ 135

221595 Bianco



INVERTER

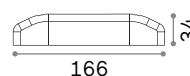

166

34



46

IP20

0,185 Kg / 0,0009 m³

⌀ 52 mm

GROUP BATTERY

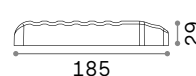

185

22



65

0,305 Kg / 0,0010 m³

⌀ 65 mm

Per ulteriori informazioni, si prega di contattare l'ufficio tecnico.



Rosoni

Rosoni magnetici

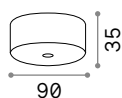

1 cavo



244235 € 13,00 244259 € 13,00 249315 € 15,00 249308 € 15,00 244242 € 13,00

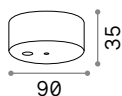

1 cavo



311265 € 14,00^{new} 328683 € 14,00^{new} 328706 € 16,00^{new} 328690 € 16,00^{new} 311272 € 14,00^{new}

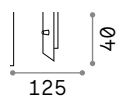

6 cavi



303390 € 20,00 303406 € 20,00 307091 € 27,00 307084 € 27,00 307077 € 20,00

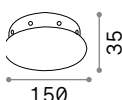

8 cavi



272429 € 21,00 272436 € 21,00 272443 € 27,00 272450 € 27,00 272467 € 21,00

Rosoni standard

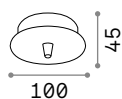

1 cavo



122823 € 10,00 122830 € 10,00 249278 € 11,00 249261 € 11,00 123295 € 10,00

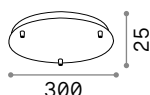

3 cavi



285580 € 33,00 285597 € 33,00 285627 € 50,00 285610 € 50,00 285603 € 33,00

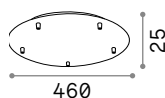

5 cavi



285634 € 60,00 285641 € 60,00 285672 € 80,00 285665 € 80,00 285658 € 60,00

Rosoni

Rosoni incasso

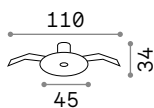

1 cavo

				
301594 € 5,00	307107 € 5,00	307138 € 5,00	307121 € 5,00	307114 € 5,00

Rosoni lineari all in

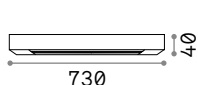

4 cavi

				
304038 € 60,00	new 328713 € 60,00	new 328744 € 80,00	new 328737 € 80,00	new 328720 € 60,00

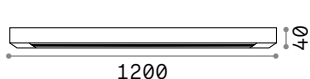

6 cavi

				
328751 € 90,00	new 304045 € 90,00	new 328782 € 135,00	new 328775 € 135,00	new 328768 € 90,00

Rosoni lineari standard

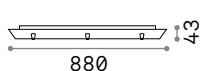

3 cavi

				
122854 € 33,00	122861 € 33,00	249292 € 55,00	249285 € 55,00	123301 € 33,00

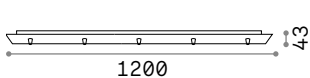

5 cavi

				
285689 € 60,00	285696 € 60,00	285726 € 75,00	285719 € 75,00	285702 € 60,00



Accessori

Portalampada

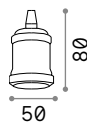

249186 € 13,00 249193 € 13,00 249223 € 13,00 249216 € 13,00 249209 € 13,00

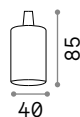

242569 € 5,00 249230 € 5,00 249254 € 5,00 249247 € 5,00 242576 € 5,00

Cavi

2x0,75 mm²
FEP T180°
PVC T90°
*only PVC



301624 € 11,00 301662* € 15,00 301655 € 12,00 301648 € 12,00 301631 € 11,00

2x0,75 mm²
FEP T180°
PVC T90°
*only PVC



301679 € 22,00 301716* € 30,00 301709 € 24,00 301693 € 24,00 301686 € 22,00

2x0,75 mm²
FEP T180°
PVC T90°
*only PVC



303062 € 30,00 306421 € 30,00 303093 € 32,00 303086 € 32,00 303079 € 30,00

Supporti



143200 € 5,00 143224 € 5,00 249339 € 5,00 249322 € 5,00 143217 € 5,00



285887 € 5,00 285894 € 5,00 285924 € 5,00 285917 € 5,00 285900 € 5,00







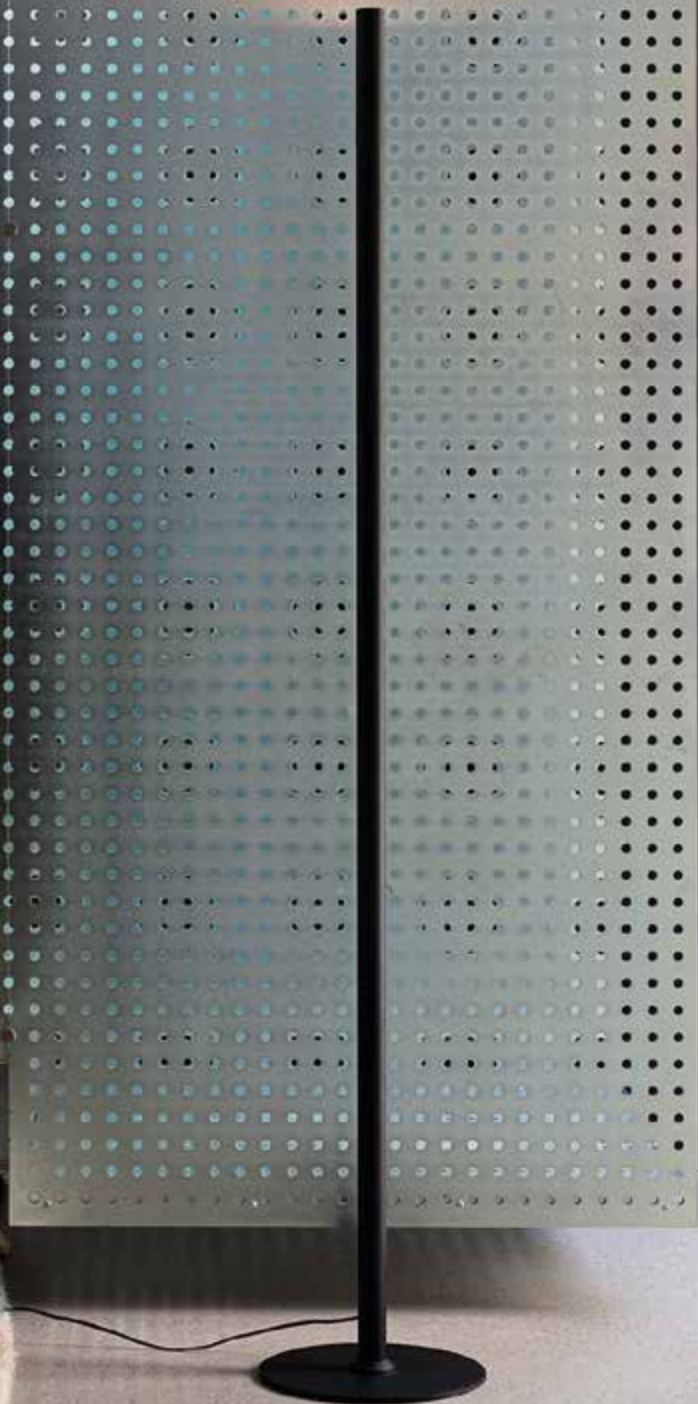











































































Look

Pag. 534



Indice famiglie

					
Alfa					
					
	330	330	427	427	
					
Angolo					
					
	344	496	526		
					
Arizona					
					
	154	154	288	288	288
					
Axel			Binomio		
					
	498	553		349	349
					
					441
					
Birds					
					
	099	337	433	494	522
					
Bubble					
					
	814	854			
					
Calypso					
					
	200	200	454		

Indice famiglie

Interno, esterno



Candy

156

156

290

486



Cantina

133

438

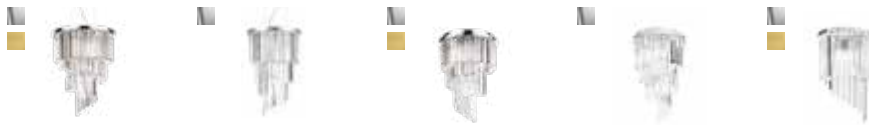

Carlton

204

204

367

367

455



Carta

166

166

166

166

293

293



397

397

484

484

545

545



Chalet

240

240

240

460

508



Cima

856

908



Clio

808

808

855

906

906



Corte

217

217

217

457



Cotton

157

157

157

291

291

291



Craft

085

386

386

538



Cylinder

193

560



Dafne

857

857

909

Desk

084

386



Diamond

096

096

096

483



Diesis

122

475

539



Driftwood

241

241

506













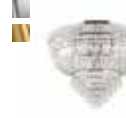
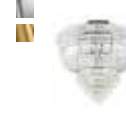
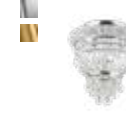
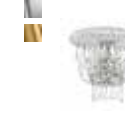























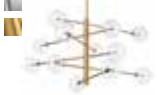



























554

554



Indice famiglie

Interno, esterno

						
Dubai	 210	 210	 365	 365	 365	 455
						
Dynamite	 090	 090	 320	Easy	 474	 539
						
Edison	 115	 428		Elio	 822	 918
						
Equinox	 102	 102	 102	 102	 102	 102
						
	 437	 525				
						
Essence	 082	 402	 402			
						
Etere	 831	 902				
						
Filo	 078	 078	 404	 404	 472	 530



Firenze

236

236

460

509

567



Florian

224

224

224

458

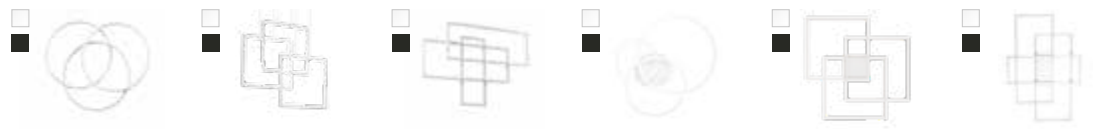

Frame

072

072

072

254

254

254

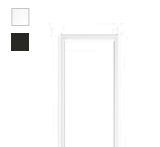

528

Frida



114



431



Futura

476

541

Gas



825



890



Gemini

060

060

060

060

282

282



282



Gioconda

228































228

228

459

Indice famiglie

Interno, esterno

						
Glim	329	329	329	705		
						
Glory	153	153	153	286	286	286
						
Gun	811	836	836			
						
Harem	239	239	462			
						
Hilton	195	195	195	448	501	501
						
	563					
						
Igor	095	095	095	432		
						
Kepler	105	105	434			



King

200

200

358

358

358



Lana

151

306

306



Lika

319

788

788

788

790

790



790

792

792



Lingotto

094

094

094

345

345

345



497

497



Linus

387

630

Litio

823

919



London

499

499

557

Indice famiglie

Interno, esterno

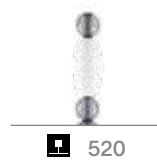
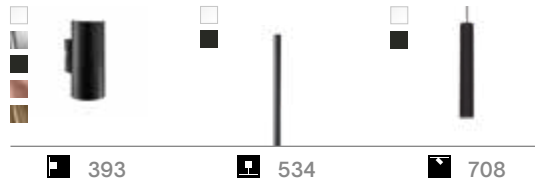
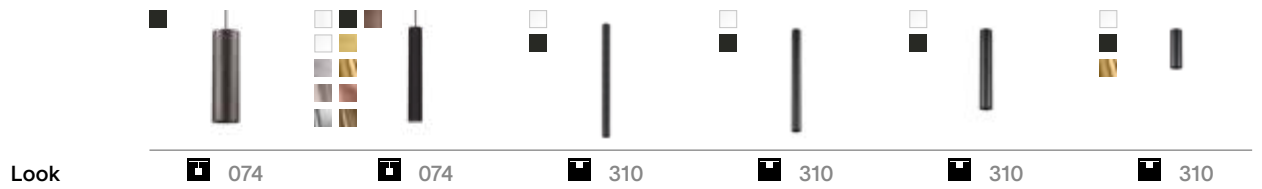



487

487

487



Maracas

331

331

436

436



Martinez

203

203

366



Minimal

116

116

430



Mix Up

126

300

536



Mouse

324

422

422

704



Multiflex

175

339



Negresco

220

220

458



Newton

438

542



Indice famiglie

Interno, esterno



Ninfea  351  351  443



Nodi  173  173  332



Nordik  192  192  450  500  560



Oak  076  076  318  318



Oby  325  325 426  426



Opera  198  198  198  456  511  565



Oracle Slim  066  066  066  066  068  068



 068  252  252  252



Ovalino

155 155 294 294 394



Oz

062 062 257 374 468



Pan

192 442



Pashà

207 207 207 357 357 357



454

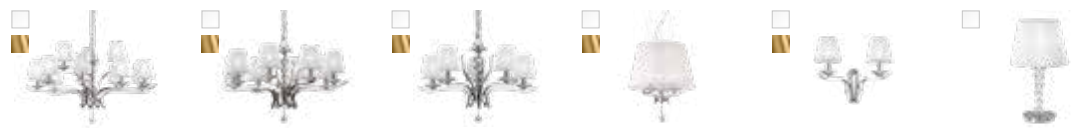

Pegaso

214 214 214 214 457 515



515 566







































































Penta

352 352 443



Indice famiglie

Interno, esterno

						
Perlage	 100	 100	 100	 100	 100	 334
						
	 334	 334	 334	 435	 435	 495
						
	 495	 524				
						
Ping Pong	 348	 348	 440	 488	 533	
						
Play	 321	 780				
						
Queen	 514	 514	 514	 566		
						
Rain	 202	 364	 364			
						
Roma	 205	 205	 356	 356	 356	 356



454



510



Rudy

326

326

423

423



Set Up

196

302

446

446

504

504



558



Sky

077

311

311

311

392



Slem

330

427

427



Smarties

152

152

152

287

287

287



287

397

485

























































485

485



Indice famiglie

Interno, esterno

Sole						
	 806	 806	 806	 806	 873	 873
Spark						
	 873	 873				
Spot						
	 105	 342				
Strauss						
	 324	 422	 422	 704		
Style						
	 229	 229	 229	 459		
Terra						
	 828	 828	 880			
Swan						
	 199	 199	 456			
Terra						
	 824	 824	 920	 920		



Triumph

092 336 436 436

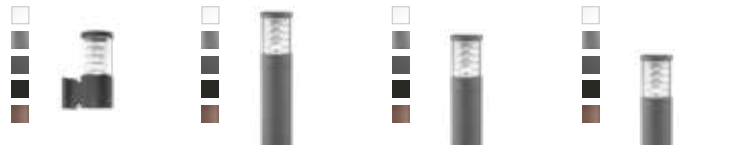

Tronco

830 896 896 896



Wally

479 543



Wheel

194 194 305 305



Winery

323 428



Woody

194 194 304 304 449



Xeno

812 826



Yoko

083 473 531





Indice per codice

deal lux



Indice per codice

SKU	Pag	016399	438	031750	189	044422	231	061160	479	080932	363
		016863	188	031996	152	044453	231	061191	479	081434	279
000206	487	016931	146	032009	152	044491	513	061450	832	081441	279
000251	491	017297	408	032016	152	044590	493	061467	832	081502	218
000268	491	017303	408	032023	287	044606	493	061474	832	081519	218
000657	356	017310	408	032030	287	044767	209	061580	847	081526	218
001197	542	017327	409	032047	287	044774	209	061597	847	081540	218
001814	147	017334	409	032078	485	044910	459	062273	551	081557	218
001821	147	017440	136	032122	164	044927	228	066387	201	081564	218
002408	229	017518	383	032139	164	044934	228	066431	214	081762	160
002880	567	018508	285	032368	499	045030	481	066448	214	082059	173
003528	542	018515	841	032375	499	045047	481	066868	847	082073	173
004716	830	018522	841	032382	557	045115	161	068138	306	082158	207
004723	896	018829	427	032436	502	045122	161	068145	306	082172	207
004730	896	018836	427	032467	502	045191	430	068169	151	082196	207
005386	408	018850	330	032504	223	045214	430	068183	234	082240	852
005881	217	019499	209	032825	938	045627	401	068190	234	082257	207
005898	217	019734	153	032832	938	045634	401	068268	456	082264	454
005911	244	019741	153	033013	836	046167	824	068275	565	082271	852
006321	330	019758	286	033020	836	046181	824	068299	198	082288	454
006338	330	019765	286	033037	920	046211	920	068305	511	082783	363
007021	408	020228	825	033044	920	046471	548	073187	358	082790	363
007045	408	020556	209	033532	211	046723	548	073255	358	083070	798
007960	306	020822	236	033662	160	049229	381	073262	358	083087	798
007977	306	020839	236	033679	160	049236	381	073408	514	083117	798
007984	306	020846	460	033952	137	051406	513	073422	514	083124	798
007991	306	020853	509	034546	378	051444	383	073439	514	083131	798
008363	202	020877	567	034706	221	051741	551	073521	422	083148	798
008370	364	022222	362	034713	221	051765	551	073545	422	083179	798
008455	364	022239	362	034720	221	051840	399	073569	422	083186	798
008608	307	023021	137	035574	216	051857	399	073583	324	083193	798
008615	307	023038	137	035581	216	051864	399	073712	332	083223	798
008622	307	024097	908	035604	224	051963	380	074139	155	083230	798
009087	164	024134	856	035611	224	051970	380	074245	139	083247	798
009131	487	025438	193	035628	224	051987	380	074313	139	083254	800
009148	164	026473	398	035635	224	052786	151	074337	139	086736	156
009155	487	026480	398	035642	458	052809	170	074344	139	086743	156
009223	287	026558	399	035659	458	052816	170	074702	492	086781	290
009360	116	026787	138	035666	141	052991	364	074726	492	086804	486
009377	427	026954	896	035680	141	053004	364	075150	224	087368	463
009407	116	026961	896	035697	141	057187	217	075181	224	087375	463
009483	427	026978	830	035710	141	057194	217	075211	461	087665	449
009513	379	026985	896	035727	151	057200	457	075389	358	087702	194
009537	379	026992	896	035826	199	059181	201	075402	358	087719	194
009681	194	027005	830	035840	199	059211	457	075419	358	087757	458
009698	194	027081	400	035864	456	059228	566	075471	448	087764	220
009933	380	027098	400	035949	451	059235	214	075488	563	087771	220
009940	380	027104	400	035956	451	059242	214	075495	195	087818	181
009957	380	027357	134	036014	305	059259	515	075501	195	087863	356
010861	285	027364	134	036021	305	059266	515	075518	195	087870	356
012865	236	027418	223	038025	394	059679	150	075525	501	087979	200
012872	236	027821	223	041742	548	059808	396	075532	501	088013	200
012889	509	027852	438	041827	211	059815	396	077734	514	088020	200
012902	460	027876	438	042794	542	059822	396	077741	514	088266	381
013046	463	028460	457	043562	164	059839	292	077758	514	088273	381
013060	463	030326	138	044163	454	060491	459	077765	566	089669	135
013657	481	030784	362	044187	200	060507	228	077796	363	089805	555
014166	381	031361	381	044200	200	060514	228	077802	363	090481	155
014395	229	031460	413	044255	230	060620	394	077819	363	090863	304
014609	556	031477	413	044279	279	061115	544	080338	359	090900	304
014814	397	031507	409	044286	279	061122	544	080345	359	091006	279
015286	542	031743	189	044293	279	061139	544	080352	359	091013	279

091112	161	096711	853	104935	074	114187	218	120324	939	124124	664
091129	381	096728	853	104942	074	114194	218	120362	940	124131	664
091136	381	096735	853	105628	194	114262	108	120386	939	124155	664
091518	825	097183	410	105710	395	114279	211	120423	857	124162	450
091525	825	097190	410	105727	395	114293	844	120430	857	124179	450
092188	848	097206	410	106175	899	114347	887	120454	909	125503	355
092195	848	097664	217	106182	899	114620	510	120898	186	125510	355
092201	848	097671	217	106205	920	114729	211	120904	186	125831	133
092218	841	098616	154	107691	801	114736	211	121130	408	126531	664
092225	886	098722	202	107707	801	114743	211	121147	408	126548	664
092300	836	098739	202	108094	478	115061	882	121154	408	126883	392
092317	836	099057	427	108117	478	115078	882	121161	408	126890	392
092324	811	099064	427	108292	956	115085	882	121178	408	126906	077
092355	847	099101	191	109138	896	115092	882	121338	408	126913	077
092393	850	100364	847	109145	896	115108	882	121352	413	128207	508
092409	850	100371	847	110233	557	115115	882	121406	555	129082	118
092416	851	100388	836	110240	557	115290	844	121437	555	129099	118
092423	851	100395	836	110356	550	115306	844	121963	833	129433	840
092430	851	100746	357	110363	550	115313	844	122014	942	129440	840
092447	851	100784	357	110417	118	115320	844	122021	942	129457	840
092836	432	100791	357	110424	118	115337	844	122045	858	129464	826
092850	095	100807	357	110431	118	115344	844	122083	114	129471	826
092881	095	100883	158	110448	499	115351	846	122106	114	129488	826
092911	208	100937	158	110455	499	115368	846	122168	954	129495	812
092942	095	100944	158	110462	118	115375	846	122205	304	129501	812
093048	205	100951	158	110530	499	115382	858	122212	304	129518	812
093062	205	101125	153	110554	499	115412	922	122236	194	129570	506
093086	454	101132	286	110745	141	115429	922	122243	194	129600	241
093093	356	101163	191	110752	141	115481	422	122557	187	129709	212
093659	130	101170	362	111117	338	115498	240	122564	187	129860	948
093697	130	101187	362	111452	560	115504	240	122663	811	129877	948
093963	294	101194	362	111841	181	115511	460	122687	811	129921	212
093994	235	101200	946	111858	181	115580	802	122717	427	130163	948
094007	235	101217	946	111865	181	115597	802	122731	330	130170	948
094014	294	101224	946	111872	216	115610	802	122748	330	130187	948
094137	170	101231	946	111896	216	115962	462	122823	958	131924	159
094182	393	101248	946	111902	170	115979	239	122830	958	131962	384
094229	170	101255	946	111919	170	116006	239	122854	958	132365	148
094236	170	101262	946	111957	106	116112	285	122861	958	132389	148
094649	363	101279	948	112268	106	116228	208	122878	512	133270	445
094663	363	101286	948	112305	186	116235	208	122885	512	133300	445
094687	362	101293	948	112312	186	116457	117	122984	427	133393	333
094786	244	101323	948	112336	186	116464	117	123080	833	134789	384
095226	154	101330	948	112343	186	116570	491	123295	958	134796	384
095264	390	101347	948	112367	136	116587	491	123301	958	134826	243
095288	390	101354	948	112626	438	116716	906	123745	849	134833	243
095615	230	101378	956	112671	116	117652	956	123769	849	134840	243
095998	393	101385	955	112695	438	117737	204	123776	849	134871	133
096018	393	101491	857	112701	133	117867	378	123783	849	134888	278
096476	822	101514	909	112718	116	117881	938	123882	948	134895	278
096483	822	101552	857	112732	133	118659	830	123899	948	134901	278
096544	929	101606	106	113302	115	118666	833	123936	955	135205	900
096551	929	101613	106	113319	115	119427	429	123943	956	135250	814
096568	929	102047	130	113678	231	119465	429	123974	776	135526	948
096575	929	103174	187	113753	844	119502	429	123981	776	135755	901
096582	929	103204	451	113760	844	119571	948	123998	776	135762	901
096599	929	103242	194	113791	845	119786	427	124001	776	135908	899
096667	853	103266	304	113975	240	120201	918	124018	776	135922	899
096674	853	103273	304	113982	800	120218	918	124025	776	135991	806
096681	853	103723	108	113999	800	120249	939	124070	654	136004	806
096698	853	103983	188	114019	800	120287	940	124087	654	136011	806
096704	853	104928	074	114170	218	120317	939	124117	654	136028	894



Indice per codice

SKU	Pag	142265	407	150130	794	156743	422	163604	836	170145	718
		142272	407	150284	796	156774	324	163611	836	170152	718
136035	894	142289	407	150291	794	156781	324	163628	836	170589	074
136042	894	142296	407	150307	794	157580	948	163635	836	170923	381
136059	894	142302	842	150420	318	157597	948	163642	811	172408	831
136073	808	142579	415	150437	318	157856	884	163666	811	172439	902
136318	175	142586	415	150468	318	158242	450	163727	920	172804	355
136325	175	142616	564	150475	318	158723	074	163741	896	172828	355
136899	392	142692	412	150635	076	158815	089	163758	896	173245	084
137391	835	142708	412	150673	076	158822	847	164823	393	173252	386
137681	129	142906	080	151649	946	158860	089	164847	393	174204	149
137827	555	142913	080	151656	946	158891	904	164878	080	174211	149
138237	084	142999	901	151663	946	158907	854	164953	228	174228	149
138251	386	143156	449	151687	948	159010	339	164960	228	174235	149
138275	108	143200	960	151694	948	159256	242	164977	207	174396	190
138305	170	143217	960	151700	948	159423	401	164984	207	174402	190
138374	428	143224	960	151717	948	159508	401	164991	357	174792	421
138510	901	144238	808	151724	948	159522	401	165004	357	174808	421
138596	274	144245	808	151731	946	159812	242	165011	198	174822	421
138602	274	144252	808	151748	946	159836	815	166247	204	174846	421
138619	274	144276	833	151755	948	159843	113	166285	366	174921	339
138633	276	144283	832	151762	948	159850	113	166322	203	174976	339
138640	276	144917	409	151779	948	159867	113	166360	203	175973	161
138657	276	145020	906	151786	948	159942	232	166889	219	176000	161
138978	798	145068	906	151793	946	159959	232	167121	424	176031	161
139012	794	145198	480	151861	948	159973	232	167152	424	176062	161
139029	794	145204	480	151946	946	159980	232	167244	226	176536	420
139098	129	145211	480	151953	946	159997	426	167251	226	176550	420
139425	114	145228	855	151960	948	160214	436	167268	226	177199	562
139432	114	145303	823	151977	948	160245	436	167398	226	177205	562
139470	890	145310	919	151991	948	160269	092	167404	226	179292	389
140179	307	145327	823	152004	948	160313	336	167411	226	179308	389
140186	307	145334	919	152851	451	160856	167	167497	110	179315	389
140193	307	145341	823	152875	305	160863	167	168036	813	179322	389
140230	159	145358	919	152899	305	161327	162	168050	813	179643	439
140339	235	146775	855	152912	305	161334	162	168111	813	179681	401
140599	459	146782	855	153162	888	161648	192	168135	813	179858	174
140605	229	146799	855	153179	888	161662	192	168326	180	180298	428
140612	229	147642	470	153193	888	161686	500	168357	180	180304	428
140629	229	147659	470	153209	888	161716	560	168364	180	180922	241
140711	162	147666	776	153926	946	161754	875	168753	222	180946	554
140728	162	147673	776	153933	946	161761	875	168777	222	180953	876
140759	162	147680	776	153940	946	161778	875	168852	245	182179	198
140841	315	147765	834	153957	948	161785	382	168869	245	183794	956
140872	315	147772	834	153964	948	161792	382	168906	231	186955	904
140902	315	147796	834	153971	948	161846	812	168913	455	186979	904
140933	315	147819	834	153988	948	161853	812	168920	367	187006	434
141046	458	148151	110	154008	955	162201	105	168937	367	187327	884
141053	220	148175	110	155142	323	162478	105	169576	718	187365	381
141060	220	148502	110	155227	323	162492	904	169583	718	187662	080
141794	074	148847	808	155722	796	162737	213	169590	718	187877	905
141800	074	148854	808	155791	318	162751	213	169606	718	187884	905
141817	074	148861	808	155869	318	163109	114	169613	718	187891	905
141855	074	148878	808	155968	109	163123	114	169620	718	187976	718
141893	175	148908	428	156026	109	163154	114	169637	718	187983	718
141909	175	148939	554	156033	109	163161	114	169644	718	187990	718
142050	427	149585	170	156682	080	163321	431	169705	718	188003	718
142067	330	149592	170	156699	080	163338	431	169712	718	188010	718
142081	427	149622	333	156705	422	163536	847	169729	718	188027	718
142098	330	149738	842	156712	324	163543	847	169736	718	188058	718
142241	415	149745	842	156729	422	163550	847	169972	718	188065	718
142258	415	150116	794	156736	422	163598	848	169989	718	188072	718

188089	718	190006	682	192758	632	197746	214	204628	664	209906	880
188096	718	190013	682	193359	768	197753	515	204635	664	211381	070
188102	718	190020	682	193366	768	198095	142	204888	476	211398	070
188119	718	190037	682	193373	768	198125	094	204895	476	211404	070
188126	718	190044	682	193380	768	198132	345	204949	541	211459	076
188195	718	190051	682	193403	768	198149	345	204956	541	211466	076
188911	946	190068	682	193410	768	198156	345	205281	111	211701	076
188928	946	190075	682	193427	768	198620	898	205298	111	211718	076
188935	946	190082	682	193434	768	198637	898	205304	111	211763	740
188942	948	190099	682	193458	768	198644	898	205311	111	211770	740
188959	948	190105	682	193465	768	199375	233	205977	312	211787	740
188966	948	190181	682	193472	768	199382	233	205984	312	211794	740
188973	948	191171	632	193489	768	199405	233	205991	312	211817	740
188980	954	191188	632	193519	768	199412	233	206004	312	211824	740
189031	956	191423	632	193526	768	200064	203	206011	312	212623	943
189062	956	191430	632	193533	768	200071	203	206028	312	212647	943
189093	955	191454	632	193540	768	200118	102	206035	312	213071	901
189109	955	191461	632	193946	479	200125	102	206042	312	213088	901
189536	682	191485	632	193991	479	200132	437	206196	786	213095	825
189574	682	191492	632	194172	080	200149	437	206202	786	213101	890
189581	682	191508	632	194189	080	200194	329	206219	786	213194	807
189598	682	191577	874	194196	080	200200	329	206226	786	213200	807
189604	682	191584	874	194202	080	200217	329	206233	786	213217	850
189611	682	191607	874	194257	718	200231	329	206240	786	213262	882
189628	682	191614	873	194295	110	200248	329	206387	086	213279	882
189635	682	191621	873	194301	718	200255	329	206394	086	213323	844
189642	682	191638	873	194677	125	200330	436	206622	238	213330	846
189659	682	191997	632	194684	125	200347	436	206639	238	213347	844
189666	682	192277	748	194806	074	200354	331	206680	113	213354	844
189673	682	192284	748	195483	872	200361	331	206820	113	213361	894
189680	682	192291	748	195490	872	200484	332	206875	113	213491	455
189697	682	192307	748	195506	872	200491	173	207155	455	213507	367
189703	682	192314	748	195704	376	200880	110	207162	365	213521	204
189710	682	192321	748	195711	376	200897	110	207186	365	213569	366
189727	682	192338	748	195728	376	200903	110	207216	210	213583	203
189734	682	192345	748	195735	376	200996	365	207582	552	214009	872
189741	682	192352	748	195742	376	201016	365	207599	552	214474	154
189758	682	192376	748	195759	376	201023	455	207834	093	214481	154
189765	682	192383	748	195766	376	201092	450	207841	093	214498	288
189772	682	192406	748	195773	376	201115	500	207858	093	214504	288
189789	682	192420	632	196190	284	201122	561	208398	172	214511	288
189796	682	192437	632	196206	284	201252	948	208541	740	214672	391
189802	682	192444	632	196220	284	201269	948	208558	740	214689	391
189819	682	192475	632	196688	426	201276	948	208565	740	214696	391
189826	682	192482	632	196695	426	201283	948	208572	740	215693	451
189833	682	192499	632	196701	325	201290	948	208589	740	215709	451
189840	682	192505	632	196718	325	201382	507	208596	740	215761	281
189857	682	192529	632	196770	120	201399	507	208640	740	215778	281
189864	682	192543	632	196787	120	202396	748	208657	740	215785	281
189871	682	192550	632	196992	089	202921	814	208664	740	215969	210
189888	682	192567	632	197302	104	202945	814	208671	740	216027	740
189895	682	192581	632	197319	104	203072	664	208688	740	216263	740
189901	682	192604	632	197326	104	203089	664	208695	740	216270	632
189918	682	192611	632	197333	104	203102	664	208701	740	216287	632
189925	682	192628	632	197500	237	203119	664	208725	740	216317	740
189932	682	192642	632	197524	237	203126	664	208732	740	216324	740
189949	682	192666	632	197654	189	203171	410	208794	442	216416	632
189956	682	192673	632	197661	189	203188	410	208817	192	216423	632
189963	682	192697	632	197708	457	203195	410	209036	954	217253	748
189970	682	192703	632	197715	214	204581	664	209043	954	218823	768
189987	682	192710	632	197722	214	204598	664	209845	828	218830	768
189994	682	192741	632	197739	214	204611	664	209852	828	218854	768



Indice per codice

SKU	Pag	223087	570	229485	066	236957	087	243566	365	246857	828
		223094	570	229492	066	236964	087	243597	210	246864	828
219875	190	223124	570	229508	066	237251	948	243665	632	246871	880
220772	768	223131	570	229515	066	237398	184	243818	798	246888	899
220789	768	223148	570	229676	705	237428	184	243825	798	246895	718
220796	768	223155	570	229683	705	237442	184	243849	798	246901	718
220802	768	223162	570	229706	704	237497	184	243924	315	246918	900
220826	632	223179	570	229720	704	237510	184	243931	315	246925	831
221489	125	223186	268	229768	704	237664	112	243948	315	246932	902
221496	125	223193	268	229782	704	237671	112	243986	782	246949	831
221502	828	223209	268	229997	794	237794	206	243993	782	246956	902
221519	828	223216	268	230580	794	237800	206	244013	782	246963	882
221595	957	223223	268	230702	254	237930	420	244181	784	246970	882
222097	070	223230	268	230726	254	238104	132	244198	784	246987	884
222103	070	223247	268	231129	394	238135	132	244204	784	246994	884
222110	070	223285	570	231228	117	238173	132	244235	958	247007	718
222257	954	223292	570	231259	117	238210	132	244242	958	247045	922
222509	674	223704	664	231273	117	238241	105	244259	958	247083	842
222523	674	223711	664	231297	117	238333	342	244549	654	247144	942
222530	674	223728	664	231341	090	238746	185	244556	654	247151	942
222547	674	223735	664	231372	090	238838	185	244563	654	247229	060
222554	674	223742	664	231396	090	238920	185	244570	654	247236	060
222561	674	223759	664	231433	090	238944	444	244587	654	247243	060
222578	674	223766	664	231471	320	238951	444	244594	654	247250	060
222585	674	223834	948	231495	320	238975	444	244624	090	247267	060
222592	674	223919	948	231556	124	239521	453	244648	090	247274	060
222608	674	223926	948	231563	124	239545	453	244662	320	247281	060
222615	674	223933	948	231570	124	239576	453	244808	758	247618	718
222622	674	223940	948	231587	124	239590	453	244822	758	247625	718
222639	674	224275	570	231594	124	239606	453	244846	758	247779	354
222646	674	224367	956	231600	124	239613	453	244853	758	247847	784
222653	674	224541	143	231631	708	240367	274	244884	319	247854	784
222660	674	224930	406	231662	708	240374	276	245041	914	247939	674
222677	674	224954	406	232041	129	241012	173	245072	914	247946	674
222684	674	224985	406	232690	121	241036	173	245089	914	247953	674
222691	674	224992	406	232713	121	241050	332	245096	914	247960	674
222707	674	225005	406	232720	121	241296	365	245102	914	247977	674
222714	674	225029	406	232744	121	241517	144	245331	503	247984	674
222745	570	225364	674	232966	322	241524	144	245348	503	247991	674
222752	570	226026	166	232980	322	241968	630	245393	503	248165	782
222769	570	226033	166	233031	322	241975	630	246390	784	248172	782
222820	943	226040	166	233062	310	241982	630	246451	718	248189	782
222837	943	226187	942	233079	310	241999	630	246468	718	248196	782
222882	570	226194	942	233192	310	242002	630	246499	718	248257	896
222899	570	226200	942	233215	310	242019	387	246505	718	248264	896
222912	570	226217	942	233321	310	242040	956	246512	718	248271	896
222929	570	227580	718	233352	310	242347	092	246529	718	248288	896
222936	570	227597	718	233666	387	242378	336	246536	718	248295	896
222943	570	227672	718	233765	311	242385	436	246543	718	248370	782
222950	570	227689	718	233772	311	242392	436	246550	718	248387	914
222967	570	227825	256	233826	311	242569	960	246567	718	248394	914
222974	570	227832	256	233833	311	242576	960	246574	718	248530	319
222981	570	229010	423	233840	387	242705	718	246581	718	248554	184
222998	570	229027	423	233970	311	243160	420	246598	718	248592	782
223001	570	229034	423	234007	311	243238	718	246604	718	248608	782
223018	570	229041	423	235455	091	243245	718	246611	718	248615	914
223025	570	229058	326	235486	091	243252	718	246628	718	248783	766
223032	570	229065	326	235516	091	243269	718	246796	815	248790	766
223049	570	229072	326	235547	091	243283	718	246819	856	248950	766
223056	570	229089	326	236841	836	243450	315	246826	856	248967	766
223063	570	229461	066	236858	836	243498	365	246833	908	248974	766
223070	570	229478	066	236865	811	243528	210	246840	908	248981	766

248998	766	250977	892	255682	936	259178	066	261188	286	266763	955
249001	766	251103	094	255781	928	259185	066	261195	174	266770	955
249018	766	251110	094	255804	928	259192	066	261287	916	267128	642
249025	766	251127	497	255934	280	259208	066	261294	916	267135	642
249032	766	251226	891	255941	280	259222	497	261331	912	267142	642
249049	766	251257	891	255989	383	259239	074	261355	912	267159	642
249056	132	251295	891	255996	718	259260	310	261362	912	267203	584
249063	132	251516	810	256030	718	259277	310	261379	912	267210	584
249070	132	251523	810	256047	718	259345	377	263434	078	267227	584
249087	132	251530	810	256061	718	259352	377	263441	078	267234	584
249186	960	251547	810	256078	718	259376	584	263519	294	267241	584
249193	960	251554	810	256085	718	259765	446	263632	144	267258	584
249209	960	251561	810	256092	718	259772	446	263649	144	267395	664
249216	960	251578	810	256115	718	259796	446	263656	144	267401	664
249223	960	251592	810	256122	718	259802	446	263663	078	267418	664
249230	960	252025	799	256146	718	259819	446	263670	078	267425	664
249247	960	252032	799	256429	140	259826	446	263687	078	267432	664
249254	960	252049	799	256436	140	259833	446	263700	078	267449	664
249261	958	252056	799	256443	140	259857	446	264523	150	267456	664
249278	958	252186	948	256528	948	259864	504	264547	150	267463	664
249285	958	252209	948	257235	377	259871	504	265278	479	267470	664
249292	958	252551	955	257242	377	259895	504	265285	479	267487	664
249308	958	252568	955	257617	584	259901	504	265292	543	267494	664
249315	958	252599	308	257624	584	259918	504	265575	402	267500	664
249322	960	252605	308	257631	584	259925	504	265643	402	267692	784
249339	960	252612	308	257648	584	259949	504	265803	289	267715	664
249452	906	252629	308	257655	584	259956	504	265827	289	267722	664
249469	906	252971	740	257662	584	259963	558	265841	289	267739	664
249476	906	252988	740	257686	584	259970	558	265896	584	267746	664
249483	906	252995	740	257709	584	259994	558	265957	066	267760	383
249490	906	253008	740	257716	584	260006	558	265971	252	267777	690
249506	906	253015	740	257730	584	260013	196	265988	252	267784	690
249513	906	253381	954	257747	584	260020	196	265995	252	267791	690
249520	906	253398	956	257792	584	260044	196	266008	252	267807	690
249629	718	253404	955	257839	584	260051	196	266015	252	267869	786
249711	784	253411	946	257846	584	260068	504	266022	252	267876	786
249728	784	253428	948	257877	584	260075	504	266121	584	267883	786
249827	803	253435	948	257990	584	260082	504	266145	584	267890	786
249834	803	253442	948	258027	584	260136	558	266183	584	267906	786
250106	417	253459	948	258140	584	260235	558	266251	956	267913	786
250113	417	253466	956	258171	584	260242	558	266282	954	267920	782
250120	417	253480	955	258232	584	260327	446	266299	956	267937	782
250137	417	253497	956	258256	584	260334	446	266305	956	267944	782
250304	170	253558	674	258270	780	260341	446	266497	762	267951	782
250311	170	253589	072	258287	321	260358	446	266503	762	267968	748
250328	170	253596	072	258300	656	260433	504	266510	762	267975	748
250335	170	253664	062	258461	760	260440	504	266527	762	267982	786
250342	170	253671	062	258478	760	260457	558	266534	762	267999	786
250359	170	253688	257	258751	070	260464	558	266541	762	268002	786
250403	690	253695	374	258768	070	260471	196	266558	762	268071	387
250410	690	253886	654	258775	070	260488	196	266565	762	268088	780
250427	690	253893	654	258874	531	260600	414	266572	762	268095	387
250434	690	254272	258	258881	473	260617	414	266589	762	268101	321
250441	690	254289	258	258898	083	260624	414	266596	762	268118	630
250458	690	254319	878	258904	531	260631	414	266602	762	268149	630
250816	889	254388	878	258911	473	260648	414	266657	762	268156	916
250823	889	254944	570	258928	083	260655	414	266671	762	268163	916
250854	858	255019	254	259017	077	260662	414	266688	762	268170	916
250878	868	255514	927	259048	445	260679	414	266701	762	268187	916
250885	868	255521	927	259062	445	260853	584	266725	762	268194	916
250946	845	255651	936	259154	066	260860	584	266732	762	268200	916
250953	892	255668	936	259161	066	261164	286	266756	955	268217	630

Indice per codice

SKU	Pag	270180	642	271538	321	276274	710	282145	389	283678	710
		270197	642	271545	321	276281	710	282152	389	283685	710
268231	630	270203	642	271590	948	276304	642	282169	389	283692	710
268293	845	270210	642	271606	948	276311	642	282176	389	283708	710
268309	845	270241	258	271613	948	276328	584	282244	893	283715	710
268316	845	270258	258	271620	946	276335	632	282251	893	283722	710
268347	858	270265	258	271637	948	276342	632	282633	584	283739	710
268354	858	270272	258	271644	946	276366	570	282640	584	283746	710
268361	858	270289	258	271712	642	277004	930	282657	584	283753	710
268422	878	270296	258	271750	642	277011	930	282664	584	283760	710
268439	878	270302	258	271880	375	277028	930	282671	584	283777	710
268989	927	270319	258	271897	375	277035	930	282688	584	283784	435
268996	927	270326	258	272030	411	277219	389	282695	584	283791	100
269009	926	270333	258	272078	476	277226	389	282701	584	283807	100
269023	926	270340	258	272085	541	277233	389	282718	584	283814	100
269115	814	270357	258	272108	912	277240	389	282725	584	283821	100
269122	814	270364	258	272139	166	277257	389	282749	584	283852	584
269139	828	270371	258	272238	498	277288	302	282756	584	283920	690
269146	828	270388	258	272245	553	277370	102	282770	584	283937	690
269153	831	270395	258	272375	955	277387	102	282787	584	283944	690
269160	902	270401	258	272382	955	277394	102	282824	584	284002	088
269221	845	270449	658	272429	958	277417	317	282848	584	284019	088
269313	842	270456	658	272436	958	277790	948	282862	584	284286	344
269320	842	270463	658	272443	958	277813	948	282879	584	284309	526
269337	072	270470	658	272450	958	277912	632	282886	584	284316	496
269351	072	270487	658	272467	958	277929	632	282893	584	284330	344
269375	072	270494	658	272474	654	277967	524	282909	584	284354	526
269382	072	270500	658	272481	654	278148	869	282916	584	284361	496
269399	374	270517	658	272498	654	278704	317	282923	584	284460	085
269405	374	270524	658	272504	654	279312	527	282930	584	284477	386
269412	257	270531	658	272511	654	279596	734	282947	584	284484	538
269429	257	270548	658	272528	654	279602	734	282954	584	284491	386
269436	062	270586	258	272535	654	279626	734	282961	584	285061	066
269443	062	270593	258	272542	654	279633	734	282978	584	285078	066
269450	062	270661	254	273167	748	279640	734	282985	584	285085	082
269467	062	270678	254	273174	748	279671	734	282992	584	285092	082
269474	468	270692	632	273631	337	279688	734	283029	584	285108	402
269481	468	270715	258	273648	099	279695	734	283036	584	285115	402
269498	468	270876	632	273655	433	279701	734	283043	584	285122	122
269504	941	270883	632	273662	522	279718	734	283050	710	285139	128
269634	704	270920	948	273679	494	279725	734	283067	710	285146	128
269696	941	270937	632	273693	343	279770	122	283104	584	285153	128
269702	941	270944	946	273709	343	279794	122	283111	584	285160	128
269719	941	270951	948	273914	388	279800	539	283142	570	285184	150
269726	941	270968	954	273945	388	280233	734	283180	570	285191	150
269733	941	270975	956	274508	706	280240	734	283258	710	285207	294
269825	254	271002	258	274515	706	280998	416	283333	475	285214	310
269832	060	271125	658	274768	756	281001	416	283524	710	285238	317
269849	060	271187	646	274775	756	281568	128	283531	710	285283	388
269856	066	271194	646	274782	756	281582	128	283548	710	285290	388
269863	066	271200	646	275178	102	282008	584	283555	710	285306	388
269870	066	271217	646	275215	102	282015	584	283562	710	285313	388
269986	446	271293	145	275369	083	282022	584	283579	710	285320	411
270005	504	271309	145	275376	083	282039	584	283586	710	285337	539
270012	558	271316	145	275383	083	282046	584	283593	710	285344	539
270029	196	271385	100	275543	182	282053	584	283609	710	285351	690
270036	446	271392	100	275567	182	282084	553	283616	710	285368	690
270043	196	271408	100	275581	182	282091	498	283623	710	285375	690
270050	196	271422	100	276182	698	282107	099	283630	710	285382	690
270104	954	271439	435	276205	926	282114	099	283647	710	285399	690
270111	954	271446	690	276243	698	282121	389	283654	710	285405	690
270173	642	271453	690	276267	710	282138	389	283661	710	285412	748

285429	748	286396	584	288260	350	292922	584	297255	648	302614	690
285436	748	286402	584	288277	350	292939	654	297262	648	302621	690
285443	748	286419	584	288338	584	292953	654	297279	648	302744	690
285450	820	286426	584	288345	954	293004	446	297743	291	302751	690
285467	820	286433	584	288383	955	293172	885	297750	291	302768	690
285474	820	286440	584	288390	126	293189	895	297767	157	302942	698
285481	820	286495	584	288406	126	293196	895	297781	157	302959	698
285498	820	286501	584	288420	126	293202	895	298597	877	302966	698
285504	820	286518	584	288437	126	293387	870	298610	877	302973	698
285511	821	286525	584	288444	126	293394	870	299402	316	302980	698
285528	821	286532	584	288451	126	293417	870	299419	316	302997	698
285535	821	286549	584	288475	126	293424	870	299617	528	303000	698
285542	889	286594	698	288482	126	293646	443	299624	528	303017	698
285559	889	286600	698	288543	956	293653	351	300436	278	303062	960
285566	956	286662	548	289151	471	293660	351	300443	278	303079	960
285573	956	286679	548	289168	471	293684	527	300498	584	303086	960
285580	958	286686	548	289212	946	293691	527	300504	584	303093	960
285597	958	286716	865	289229	946	293769	296	300511	584	303314	314
285603	958	286723	865	289236	948	293776	296	300528	584	303321	314
285610	958	286730	865	289243	948	293783	296	300535	584	303390	958
285627	958	286747	865	289250	948	293790	296	300542	584	303406	958
285634	958	287072	389	289281	584	294001	885	300641	893	303499	584
285641	958	287300	418	289298	584	294025	885	300658	893	303505	584
285658	958	287317	418	289304	584	294032	885	300764	584	303512	584
285665	958	287560	382	289489	340	294049	885	300801	078	303529	584
285672	958	287577	382	289496	340	294766	423	300818	078	303536	584
285689	958	287584	382	289786	168	294803	423	300825	078	303543	584
285696	958	287591	385	289861	168	294810	326	301051	530	303550	584
285702	958	287607	385	289878	168	294827	326	301068	530	303567	584
285719	958	287614	385	289908	168	295213	532	301075	530	303574	584
285726	958	287621	385	289915	168	295473	539	301525	322	303581	584
285887	960	287638	385	289939	168	295497	539	301532	322	303598	584
285894	960	287645	385	290614	584	295503	539	301594	958	303604	584
285900	960	287652	407	290621	570	295510	474	301624	960	303611	584
285917	960	287669	407	290775	309	295534	474	301631	960	303628	584
285924	960	287676	407	290799	309	295541	474	301648	960	303635	584
285993	584	287683	827	290812	309	296197	948	301655	960	303642	584
286006	584	287690	827	290836	309	296210	948	301662	960	303659	584
286051	584	287706	827	290959	525	296302	584	301679	960	303666	584
286068	584	287713	827	290966	525	296333	702	301686	960	303673	584
286075	584	287720	827	291093	475	296340	702	301693	960	303680	584
286082	584	287737	827	291109	475	296357	702	301709	960	303697	584
286099	584	287768	400	291345	071	296364	702	301716	960	303703	584
286105	584	287775	400	291376	071	296456	664	302225	407	303710	584
286112	584	287782	400	291406	071	296463	664	302232	407	303727	584
286129	584	287843	734	291789	419	296678	540	302256	656	303734	584
286167	584	287850	734	291796	419	296685	540	302263	656	303741	584
286204	584	287867	734	292076	183	296746	100	302270	656	303789	584
286211	584	287874	734	292083	183	296753	100	302287	656	303796	584
286228	584	287881	734	292090	183	296869	955	302294	656	303802	584
286259	584	287898	734	292113	183	296876	955	302348	570	303819	584
286266	584	287904	734	292205	258	297101	295	302355	570	303826	584
286297	584	287911	734	292236	258	297149	295	302362	570	303833	584
286303	584	287928	734	292250	258	297163	648	302379	570	303895	060
286310	584	287935	734	292403	435	297170	648	302539	690	304038	958
286327	584	287942	734	292410	435	297187	648	302546	690	304045	958
286334	584	287959	654	292441	495	297194	648	302553	690	304113	504
286341	584	287966	654	292458	495	297200	648	302560	690	304120	558
286358	584	288147	734	292465	495	297217	648	302577	690	304137	345
286365	584	288208	954	292472	495	297224	648	302584	690	304144	094
286372	584	288215	954	292830	300	297231	648	302591	690	304151	497
286389	584	288239	956	292847	300	297248	648	302607	690	304168	546



Indice per codice

SKU	Pag	306445	278	307404	126	311364	341	314198	520	318714	904
		306452	540	307411	126	311661	864	314204	482	318721	904
304366	066	306469	540	307428	126	311678	864	314228	346	318820	873
304373	066	306513	316	307435	126	311685	864	314235	346	318837	806
304380	066	306520	316	307442	452	311708	864	314303	317	319568	312
304397	066	306537	102	307459	452	311715	867	314334	443	319575	312
304403	066	306544	102	307466	452	311760	405	314716	328	319582	312
304410	066	306551	102	307473	452	311777	405	314723	328	319650	748
304427	066	306575	258	307480	452	311784	405	314815	352	319667	748
304434	066	306582	258	307497	452	312118	774	314822	352	319674	748
304441	066	306599	258	307503	452	312125	774	314921	064	319681	748
304458	066	306605	258	307510	584	312132	774	314938	064	319704	890
304465	066	306612	258	307527	584	312156	774	315805	360	319797	316
304472	066	306629	258	307534	584	312163	774	315812	360	319803	316
304489	374	306636	258	307541	584	312170	774	316048	888	319810	831
304496	374	306643	258	307558	584	312323	298	316055	888	319827	902
304502	374	306650	258	307565	584	312330	298	316192	707	320434	584
304519	257	306667	258	307572	584	312347	298	316208	707	320441	584
304526	257	306674	258	307589	584	312354	298	316215	707	320458	584
304533	257	306681	258	307596	584	312361	298	316239	707	320465	584
304540	062	306698	258	307602	584	312378	298	316307	584	320472	584
304557	062	306780	895	307619	956	312477	353	316680	350	320489	584
304564	062	306797	895	307626	956	312491	353	316697	350	320496	584
304571	062	306803	895	307695	060	312507	353	316772	797	320502	584
304588	062	306810	419	307701	060	313191	748	316871	859	320519	584
304595	062	306827	419	307756	760	313207	748	316895	859	320526	584
304601	446	306834	885	307855	955	313252	440	316901	859	320533	584
304618	504	306841	885	307862	955	313283	348	317007	350	320540	584
304625	558	306858	885	307879	954	313290	348	317090	397	320557	584
304632	196	306865	885	307886	954	313313	533	317106	397	320564	584
304649	546	306872	885	308227	895	313320	488	317113	293	320571	584
304694	060	306889	948	308234	895	313344	480	317120	293	320588	584
304700	060	306896	948	309262	334	313351	480	317137	545	320595	584
304717	060	306940	443	309279	334	313368	480	317144	545	320601	584
304724	060	306957	351	309286	334	313412	843	317151	484	320618	584
304731	060	306964	351	309798	178	313429	843	317168	484	320625	584
304748	060	306988	524	309804	178	313436	843	317243	102	320717	584
304915	534	306995	099	309811	178	313443	843	317250	102	320724	584
304922	534	307008	099	309866	866	313450	843	317267	107	320731	584
305264	490	307015	385	309873	866	313467	838	317274	107	320748	584
305271	490	307022	385	310107	472	313474	838	317281	107	321172	098
305288	096	307039	385	310114	472	313481	838	317489	317	321509	423
305295	096	307046	385	310121	472	313498	838	317496	317	321516	326
305325	096	307053	385	310138	404	313504	838	317502	317	321523	326
305349	483	307060	385	310145	404	313511	839	317564	845	321530	423
305431	954	307077	958	310152	404	313528	839	317571	845	321547	382
305486	954	307084	958	310589	123	313535	839	317793	100	321554	382
305592	541	307091	958	310596	123	313542	839	317809	435	321561	382
305608	584	307107	958	310602	123	313559	839	317816	524	321578	452
305615	584	307114	958	310664	441	313566	839	317823	495	321585	541
305622	948	307121	958	310671	349	313771	107	317908	296	321592	296
305639	948	307138	958	310688	349	313788	107	317915	296	321615	296
305813	786	307145	664	310787	396	313894	074	317953	584	321622	920
305837	786	307152	664	310800	164	314013	058	317960	584	321639	904
305844	760	307169	827	310817	487	314037	058	317977	584	321646	845
305851	760	307176	827	310886	317	314099	425	317984	584	321653	584
306346	309	307183	389	310893	317	314105	425	317991	584	321660	276
306360	309	307190	389	311265	958	314129	425	318264	270	321677	584
306384	309	307206	296	311272	958	314136	425	318516	912	321684	274
306407	309	307213	296	311319	441	314143	176	318523	912	321691	845
306421	960	307244	258	311340	341	314167	176	318691	880	321707	276
306438	278	307251	664	311357	341	314174	176	318707	880	321714	584

321721	584	322346	690	323961	726	326856	842	327969	322	328584	838
321738	274	322353	880	323985	726	326863	827	327976	322	328591	838
321745	276	322360	690	324005	726	326870	827	327983	322	328607	838
321752	274	322377	690	324272	718	326887	810	327990	058	328614	867
321769	276	322384	880	324289	718	326894	810	328003	058	328621	859
321776	274	322391	690	324296	718	326900	888	328010	282	328638	859
321783	080	322407	825	324302	718	326917	888	328027	282	328645	859
321790	584	322414	890	324319	718	326924	888	328034	282	328652	843
321806	584	322421	890	324326	718	326931	888	328041	282	328669	843
321813	080	322438	880	324333	718	326955	844	328058	282	328676	843
321820	584	322452	880	324340	718	326962	830	328065	282	328683	958
321837	584	322483	880	324357	718	326979	846	328072	282	328690	958
321844	584	322506	880	324364	718	326986	844	328089	282	328706	958
321851	904	322537	880	324371	718	326993	844	328096	282	328713	958
321868	904	322544	880	324388	718	327365	168	328102	107	328720	958
321875	904	322551	880	324395	718	327372	168	328119	107	328737	958
321882	904	322568	880	324401	718	327389	168	328126	107	328744	958
321899	584	322575	880	324418	718	327396	168	328133	107	328751	958
321905	904	322582	880	324425	718	327402	168	328140	298	328768	958
321912	584	322599	880	324807	726	327419	168	328157	298	328775	958
321929	904	322605	848	324814	726	327426	168	328164	536	328782	958
321936	584	322612	880	324821	726	327433	168	328171	536	328799	317
321943	584	322629	828	324838	726	327440	168	328188	328	328805	317
321950	904	322636	828	324845	726	327457	168	328195	328	328812	317
321967	584	322643	828	324852	726	327471	760	328201	341	328829	906
321974	584	322650	828	324869	726	327488	760	328218	341	328836	906
321981	904	322667	350	324876	726	327495	760	328225	341	328942	282
321998	584	322674	350	324883	726	327501	786	328232	348	328959	282
322001	584	322681	828	324890	726	327518	786	328249	348	328966	282
322018	912	322698	350	324906	726	327525	584	328256	348	328973	282
322025	584	322704	828	324913	726	327532	584	328263	348	328980	282
322032	584	322711	312	324920	726	327549	584	328270	440	329260	282
322049	912	322728	850	324937	726	327556	584	328287	440	329444	616
322056	584	322735	850	325620	930	327563	270	328294	488	329451	616
322063	584	322742	435	325637	930	327570	270	328300	488	329468	616
322070	584	322759	495	325644	930	327600	270	328317	533	329475	616
322087	698	322766	100	325651	930	327686	270	328324	533	329505	616
322094	698	322773	100	325668	930	327693	270	328331	123	329512	616
322100	698	322780	100	325675	930	327723	797	328348	123	329529	616
322117	912	322797	100	325682	930	327730	797	328355	123	329536	616
322124	698	323527	726	325699	930	327747	797	328362	353	329574	616
322131	912	323534	726	325705	930	327754	748	328379	334	329581	616
322148	912	323541	726	325712	930	327761	748	328386	334	329598	616
322155	831	323558	726	325729	930	327778	404	328393	334	329604	616
322162	912	323589	726	325736	930	327785	404	328409	334	329635	616
322179	831	323596	584	325750	584	327792	404	328416	334	329642	616
322186	831	323602	726	325767	584	327808	334	328423	334	329666	616
322193	831	323619	726	326610	946	327815	334	328430	349	329673	616
322209	831	323633	726	326627	842	327822	334	328447	349	329703	616
322216	880	323640	726	326634	842	327839	094	328454	349	329710	616
322223	902	323657	726	326689	878	327846	094	328461	349	330358	616
322230	880	323671	726	326696	878	327853	345	328478	441	330365	616
322247	902	323688	726	326702	878	327860	345	328485	343		
322254	902	323718	726	326719	878	327877	497	328492	360		
322261	902	323725	726	326726	878	327884	157	328508	864		
322278	902	323732	726	326733	878	327891	291	328515	864		
322285	858	323763	726	326740	878	327907	485	328522	839		
322292	858	323770	726	326757	878	327914	485	328539	839		
322308	858	323794	726	326788	855	327921	425	328546	839		
322315	858	323800	726	326795	808	327938	425	328553	839		
322322	690	323817	726	326801	808	327945	405	328560	839		
322339	690	323831	726	326849	842	327952	322	328577	839		

Elenco finiture



Trasparente



Bianco



Cromo Sfumato



Acciaio



Argento

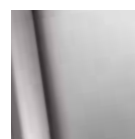

Cromo



Cemento



Alluminio



Grigio

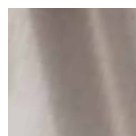

Nickel



Fumè



Granito

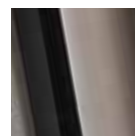

Piombo



Antracite



Nero



Avorio



Ambra



Alabastro



Beige



Canvas



Legno



Tortora



Corda



Oro

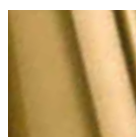

Ottone

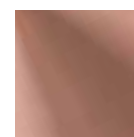

Rame



Coffee



Brunito



Ruggine

Note

Le finiture rappresentate hanno scopo illustrativo. Le tonalità sono soggette a variazioni dettate dal tipo di materiale impiegato e dalla sua lavorazione che possono alterarne la resa, di conseguenza articoli catalogati con medesima finitura potranno presentare delle differenze nella percezione del colore.

Icone tecniche



Classe I Sicurezza elettrica garantita dall'isolamento principale e da un conduttore di protezione (messa a terra) collegato alla struttura metallica della lampada. Messa a terra obbligatoria.



Classe II Sicurezza elettrica garantita dall'isolamento principale e da un doppio isolamento o da un isolamento rinforzato. Non deve avere messa a terra.



Classe III Sicurezza elettrica garantita dall'alimentazione a bassissima tensione (inferiore a 50 Volt). Non deve avere messa a terra.



Apparecchio non idoneo al montaggio diretto o incasso su superfici normalmente infiammabili.



Marchio di conformità alle direttive comunitarie europee di sicurezza.

Simboli



Lampadina inclusa.



Articoli con lampade a LED: consumo estremamente ridotto, luce chiara e concentrata, robustezza e lunga durata.



Interruttore integrato nel corpo luce.



Apparecchio dotato di interruttore touch: si accende e si regola l'intensità col tocco di un dito sul corpo luce.



Apparecchio fornito con variatore di potenza.



Lampada con presa USB integrata.



Luce indiretta inclusa.



Prodotto ad alto contenuto tecnologico, elevata qualità dei materiali, destinato ad uso professionale.



Articolo con UGR.



Articolo adatto alla pittura e verniciatura.



Grado di protezione.



Articolo in acciaio inox 316.



Lampada con rilevazione di presenza inclusa PIR (Passive InfraRed).



Lampada con batteria ricaricabile inclusa.

Note

-I prezzi indicati sono riferiti al pubblico IVA esclusa.

-Ideal lux s.r.l. si riserva il diritto di apportare, in qualunque momento e senza preavviso, tutte le modifiche necessarie a migliorare la qualità degli articoli illustrati nel presente catalogo. Per verificare le caratteristiche più aggiornate, consultare la documentazione nel sito web (www.ideal-lux.com).

-I nostri prodotti in classe I e II si alimentano con tensione nominale di 220-240 vac 50/60 hz. Tutti i nostri prodotti sono conformi alle direttive CE.

-Qualora acquistato separatamente come "optional", il driver dimmerabile sarà già incluso nel prodotto in sostituzione del driver standard on-off: verrà fornito un solo driver.

-I Watt indicati a catalogo esprimono la potenza NOMINALE dell'articolo comprensivo di sorgente e driver, quando inclusi. I valori riferiti ai lm relativi alle lampade con sorgenti integrate a LED, sono da considerarsi NOMINALI,

riferiti cioè alla sorgente. Per i lm effettivi dei singoli apparecchi illuminanti si prega gentilmente di consultare le fotometrie.

-Il valore UGR non è una caratteristica dell'apparecchio, ma dell'installazione. Gli UGR riportati in questo catalogo sono stati calcolati tenendo conto di un'installazione ideale e sono raggruppati nei blocchi <10 <13 <16 <19 <22. Si consiglia di calcolare l'UGR specifico secondo la propria installazione.

-La durata di vita utile delle sorgenti LED di tutti gli articoli presenti a catalogo è riferita al valore L70B50, quando non dichiarato altrimenti.

Ideal Lux s.r.l.

Headquarter

Via Taglio Destro, 32
30035 Mirano – Venezia
P.I. / C.F. 02420040277
8.00 - 12.00 / 13.30 - 17.30

Warehouse

Via delle Industrie, 8/D
30036 Santa Maria di Sala – Venezia
8.00 - 12.00 / 13.00 - 17.00

E info@ideal-lux.com

T +39 041 5790500

F +39 041 8872349

© [ideal.lux](https://www.ideal-lux.com)

f Ideal Lux

www.ideal-lux.com

Community Design Pending Nr. 001996372 002194993 002621862 002943449 003734342 004558609 006083655

Copyright 2024 © IDEAL LUX S.r.l. – All rights reserved – Tutti i diritti sono riservati



