

STICK SURFACE

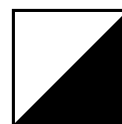
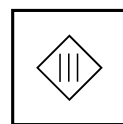
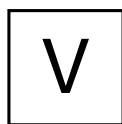

48 V DC

1000 mm NE
2000 mm NE
1000 mm BI
2000 mm BI

329574
329581
364063
370859

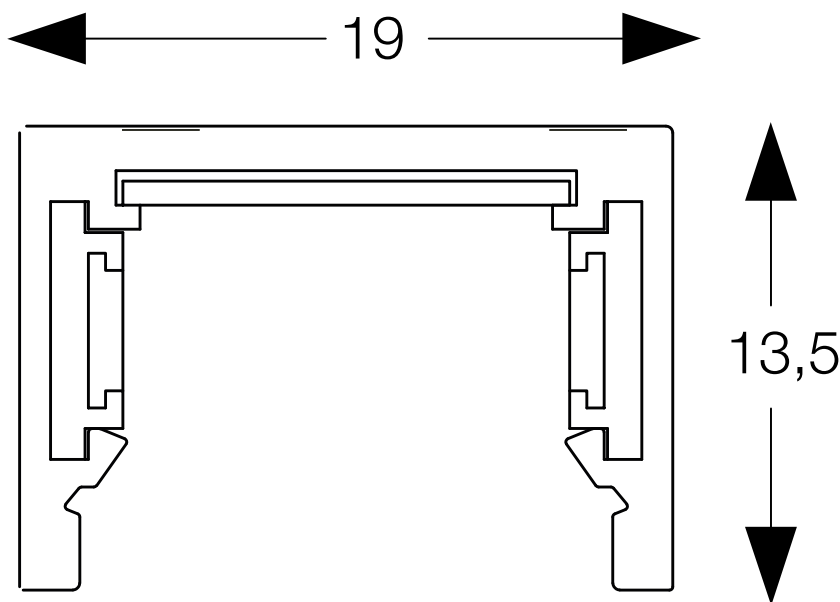

Ideal Lux non è responsabile della sicurezza e del funzionamento del sistema STICK in caso si utilizzino componenti non appartenenti ad esso o qualora le istruzioni di montaggio non vengano rispettate.
Ideal Lux is not responsible for the safety and operation of the STICK System if the components used are not belonging to the System itself or if the assembly instructions are not respected.

Massimo carico meccanico applicabile al binario 10kg / m. Assicurare il binario al soffitto esclusivamente dopo aver completato la propria sequenza. Ricordarsi di associarvi gli appositi kit di montaggio e non in dotazione a seconda delle proprie esigenze. / Maximum mechanic load 10 kg / m. Secure the track to the ceiling only after completing your sequence. Remember to associate the appropriate assembly kits not included.

L'INSTALLAZIONE DI QUESTO APPARECCHIO DEVE ESSERE EFFETTUATA DA PERSONALE QUALIFICATO
 THE LIGHTING FITTING SHOULD BE INSTALLED BY A QUALIFIED ELECTRICIAN

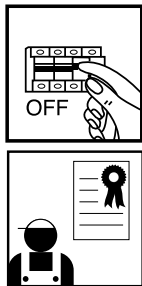

1

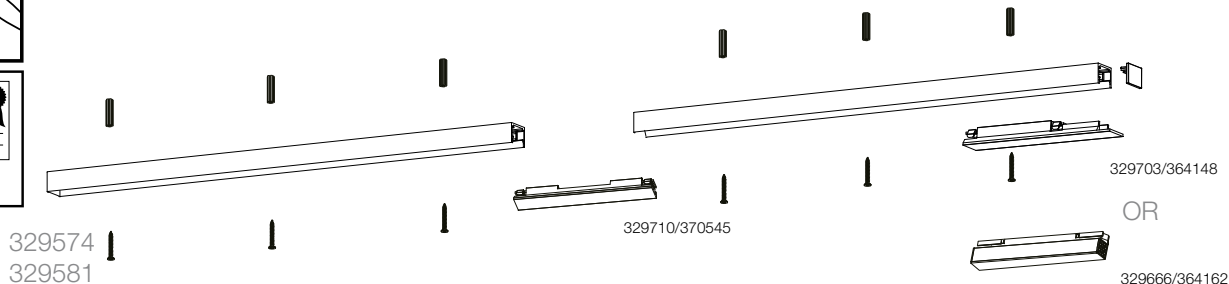

Scegliere la versione del track idoneo alle proprie esigenze.
 Choose the track's version that suits your needs.

Collegamento 48V - 48V diagram

2

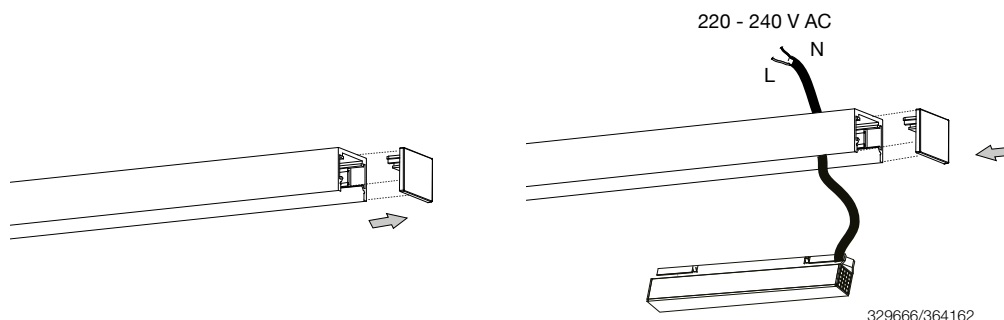

Inserire il STICK POWER SUPPLY LINEAR nel profilo. Attenzione, il Connettore è magnetico. Chiudere con l'end cap.
 Cablare il profilo a soffitto. Attenzione! L'articolo non contiene né driver né morsettiere. Insert the STICK POWER SUPPLY LINEAR into the profile. Warning, the Connector is magnetic.
 Close with the end cap. Wire the ceiling profile. Warning! The item does not contain drivers or terminal blocks

OPZIONALE / OPTIONAL - Collegamento 1-10V - 1-10V diagram (329673)

2B

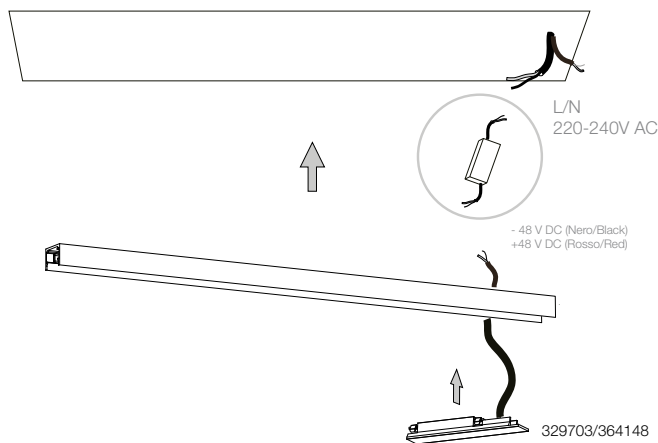

Collegamento 1-10V - 1-10V diagram

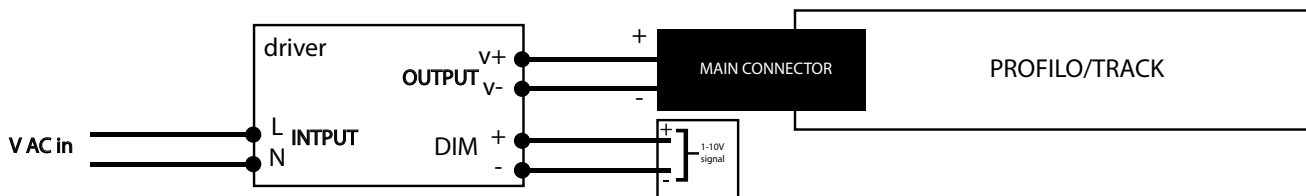

Cablare il profilo al soffitto. Attenzione! Morsetteria IP20 2 x 0,75 mm² NON INCLUSA. Usare cavo di sezione 2 x 0,75 mm². Distanza massima fra driver e testata 5m.
 Lunghezza massima di elettrificazione del circuito 20 m (installazione in linea continua). Potenza massima installabile 150 W. Attenzione! Per limitare il rischio di surriscaldamento e di incendio non cortocircuitare i conduttori. Secondo alcune normative l'articolo deve essere effettuata da un elettricista qualificato. Il profilo va collegato solo ad alimentazione SELV.
 Wire the track to the ceiling. Warning! IP20 terminal block 2 x 0,75 mm² NOT INCLUDED. Use a cable with a section of 2 x 0,75 mm². Maximum distance between driver and head 5m.
 Maximum length of electrified circuit 20 m (installation in continuous line). Maximum installable power 150 W. Warning! To limit the risk of overheating and fire, do not short-circuit the conductors. As indicated by specific regulations, the lighting fitting should be installed by a qualified electrician. The track must be connected only to SELV power supply.

LA SICUREZZA DI QUESTO APPARECCHIO È GARANTITA SOLO CON L'USO APPROPRIATO DI QUESTE ISTRUZIONI, PERTANTO È NECESSARIO CONSERVARLE
 THE SAFETY AND RELIABILITY ARE GUARANTEED ONLY WHEN INSTALLATION INSTRUCTIONS ARE PROPERLY FOLLOWED. PLEASE KEEP THIS INSTRUCTION SHEET FOR FUTURE REFERENCE.

L'INSTALLAZIONE DI QUESTO APPARECCHIO DEVE ESSERE EFFETTUATA DA PERSONALE QUALIFICATO
 THE LIGHTING FITTING SHOULD BE INSTALLED BY A QUALIFIED ELECTRICIAN

3

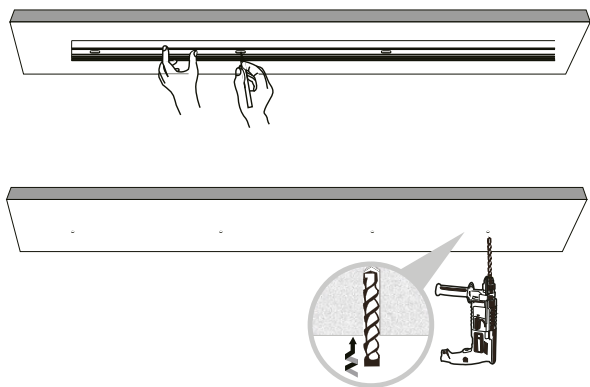

Fissare il profilo a soffitto (almeno 1 vite ogni 90-100 cm): qualora siano presenti, forare eventuali asole lungo la lastra magnetica interna al profilo.
 Fix the profile onto the ceiling (at least 1 screw every 90-100 cm): if they are present, drill the holes along the magnetic sheet inside the profile.

4

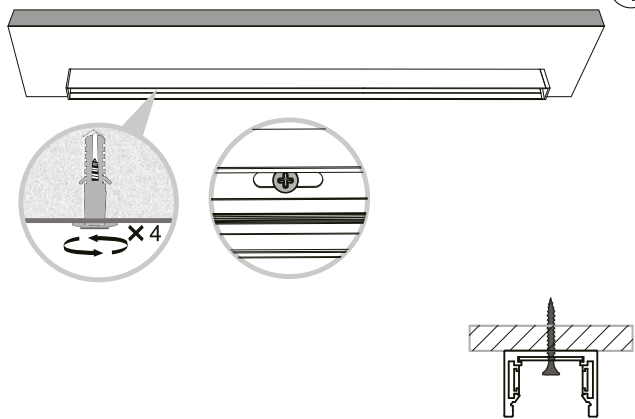

Stringere bene le viti per ancorare il profilo al soffitto.
 Tighten the screws well to anchor the track to the ceiling.

5

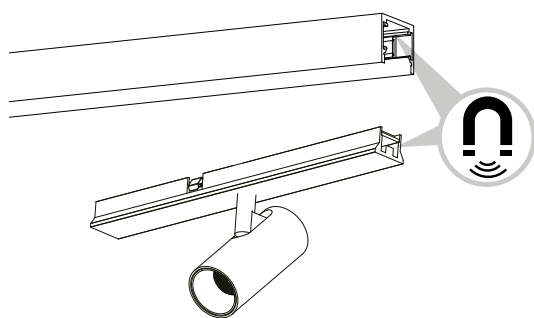

L'installazione degli apparati luminosi deve avvenire rispettando il senso dei poli riportati sui dispositivi. Binario e apparati sono magnetici.
 The installation of the luminous devices must take place respecting the poles' direction indicated on the devices. Trak and devices are magnetic.

6

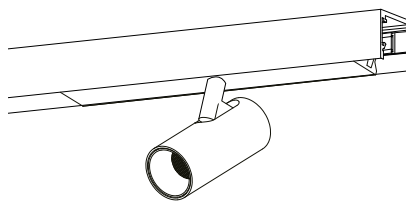

CONNESSIONE A PLAFONE DI PROFILI MULTIPLI
 MULTIPLE CEILING SYSTEM CONNECTION

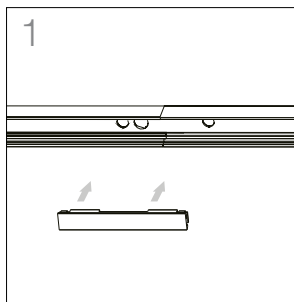

1A

Nel caso si necessiti di prolungare il proprio sistema lineare eseguire i passaggi da 1 a 2
 If you need to extend your Linear system, follow steps 1 to 2.

Per implementare la quantità del proprio sistema accostare il profilo all'altro: ancorare i profili tramite l'apposito STICK STRAIGHT CONNECTOR.
 To implement the quantity of your system, place the profile next to the other: fix the tracks using the special STICK STRAIGHT CONNECTOR. Be sure to tighten

firmly the screw for a correct procedure. The device is magnetic.

2A

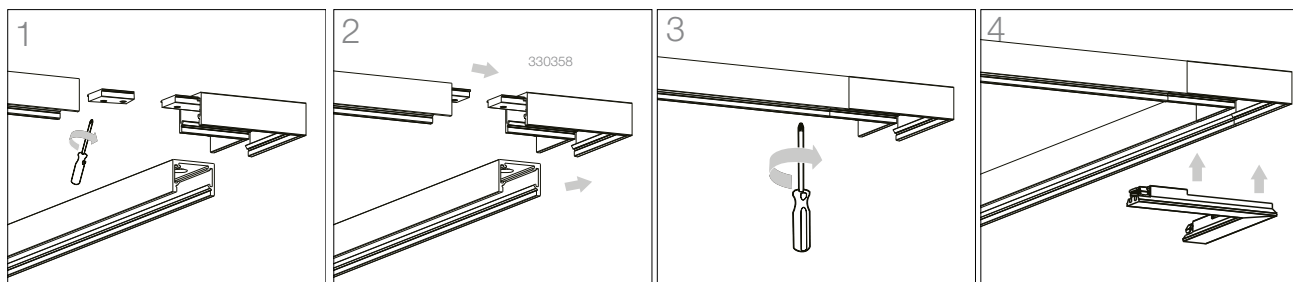

Unire i profil al supporto angolare tramite la staffa lineare presente STICK SURFACE L-CONNECTOR. Assicurarsi di stringere con forza la vite per una corretta procedura. Inserire STICK ELECTRICAL L CONNECTOR (compreso nel kit sopracitato) per permettere la continuità del flusso elettrico. L'apparato è magnetico. Procedere in seguito ai passaggi da 3 a 6.
 Join the track to the corner advice using the linear bracket included in the STICK SURFACE L-CONNECTOR. Be sure to tighten firmly the screw for a correct procedure. Insert the STICK ELECTRICAL L CONNECTOR (included in the aforementioned kit) to allow continuity of the electrical flow. The device is magnetic. Then proceed to steps 3 to 6.

LA SICUREZZA DI QUESTO APPARECCHIO È GARANTITA SOLO CON L'USO APPROPRIATO DI QUESTE ISTRUZIONI, PERTANTO È NECESSARIO CONSERVARLE
 THE SAFETY AND RELIABILITY ARE GUARANTEED ONLY WHEN INSTALLATION INSTRUCTIONS ARE PROPERLY FOLLOWED. PLEASE KEEP THIS INSTRUCTION SHEET FOR FUTURE REFERENCE.

L'INSTALLAZIONE DI QUESTO APPARECCHIO DEVE ESSERE EFFETTUATA DA PERSONALE QUALIFICATO
THE LIGHTING FITTING SHOULD BE INSTALLED BY A QUALIFIED ELECTRICIAN

ACCESSORI /
ACCESSORIES

329703/364148

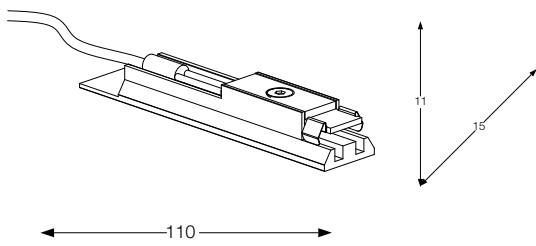

329710/370545

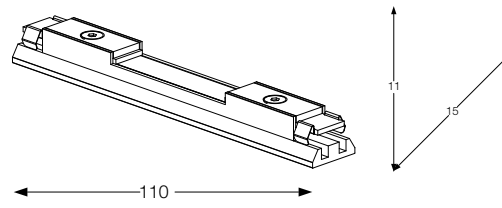

329741

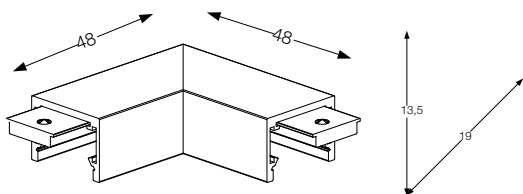

OR (DEPENDING OF THE SYSTEM)

329758/364155

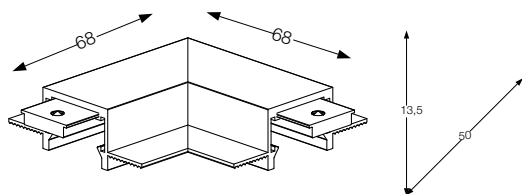

329734/372730

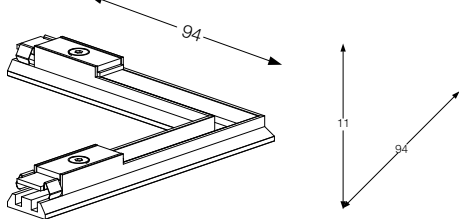

329666/364162

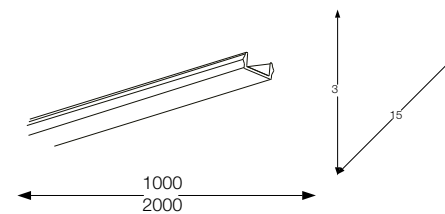
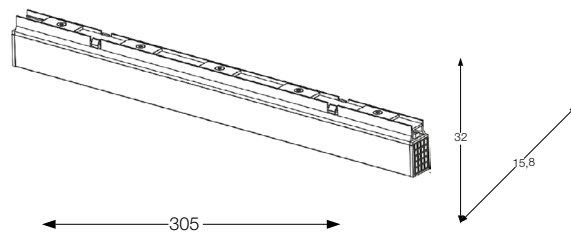

L'INSTALLAZIONE DI QUESTO APPARECCHIO DEVE ESSERE EFFETTUATA DA PERSONALE QUALIFICATO
 THE LIGHTING FITTING SHOULD BE INSTALLED BY A QUALIFIED ELECTRICIAN

8021696344980
 8021696329468
 8021696364087

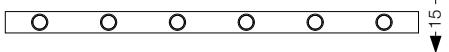
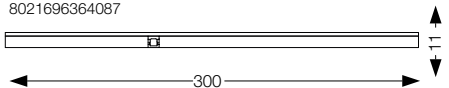

8021696344997
 8021696343525
 8021696364094

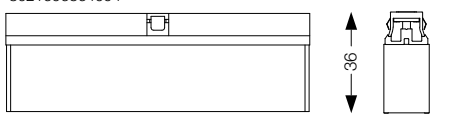

8021696345000
 8021696329475
 8021696369921

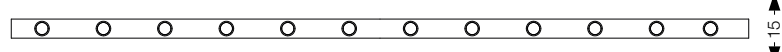
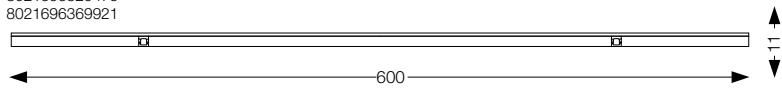

8021696345017
 8021696343532
 8021696369952

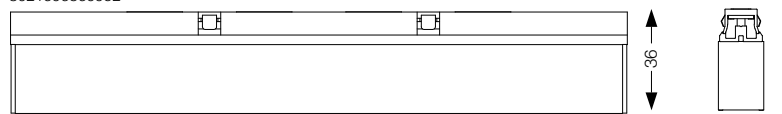

8021696345086
 8021696329444
 8021696364131

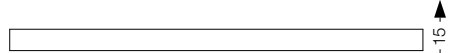

8021696345093
 8021696329451
 8021696374291



8021696345024
 8021696329512

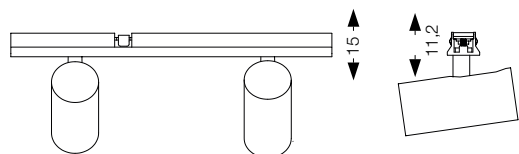
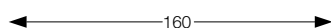

8021696345031
 8021696329536

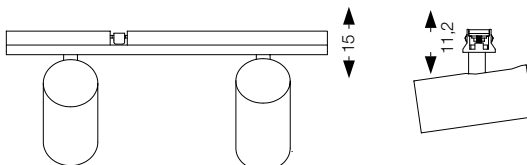
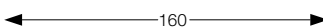

8021696345048
 8021696329505

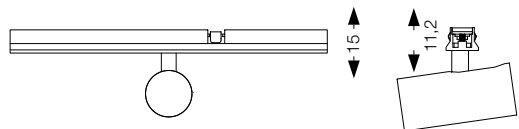
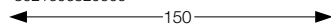

8021696345055
 8021696329529

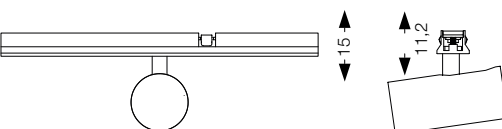
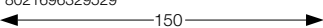

8021696345062
 8021696343501
 8021696345079
 8021696343518

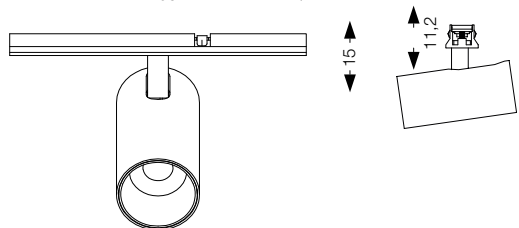
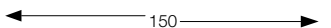

LA SICUREZZA DI QUESTO APPARECCHIO È GARANTITA SOLO CON L'USO APPROPRIATO DI QUESTE ISTRUZIONI, PERTANTO È NECESSARIO CONSERVARLE
 THE SAFETY AND RELIABILITY ARE GUARANTEED ONLY WHEN INSTALLATION INSTRUCTIONS ARE PROPERLY FOLLOWED. PLEASE RETAIN THIS INSTRUCTION SHEET FOR FUTURE REFERENCE.

TAGLIO PROFILO / TRACK CUT

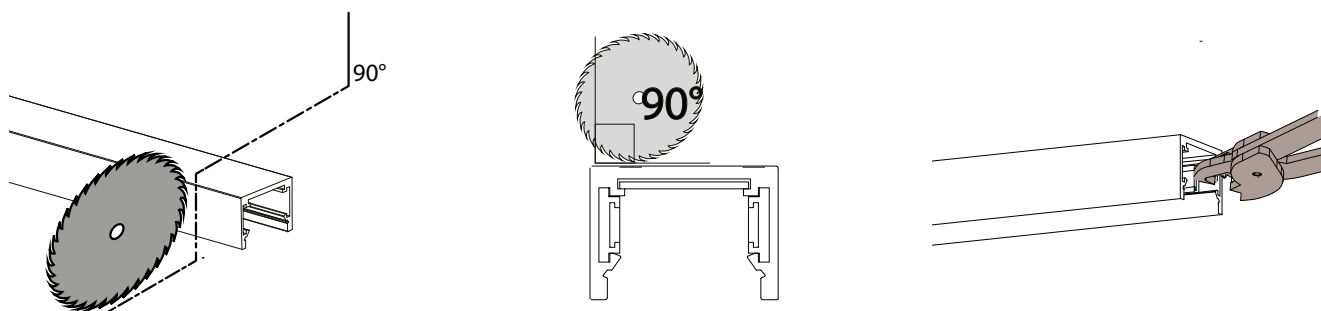

Tagliare opzionalmente il profilo lineare alla misura desiderata mediante taglio laser (procedura raccomandata) oppure con una sega circolare per profili di metallo. A taglio avvenuto, rettificare in accorciamento le estremità dei conduttori in rame interni al profilo con una tenaglia.

If needed, cut the linear profile to the desired length through laser cutting (recommended operation) or alternatively with a circular saw designed for metal profiles. After the cut is made, rectify and shorten the outer ends of the copper conductors inside the profile with pincers.

INSERIMENTO COVER / COVER INSERTION

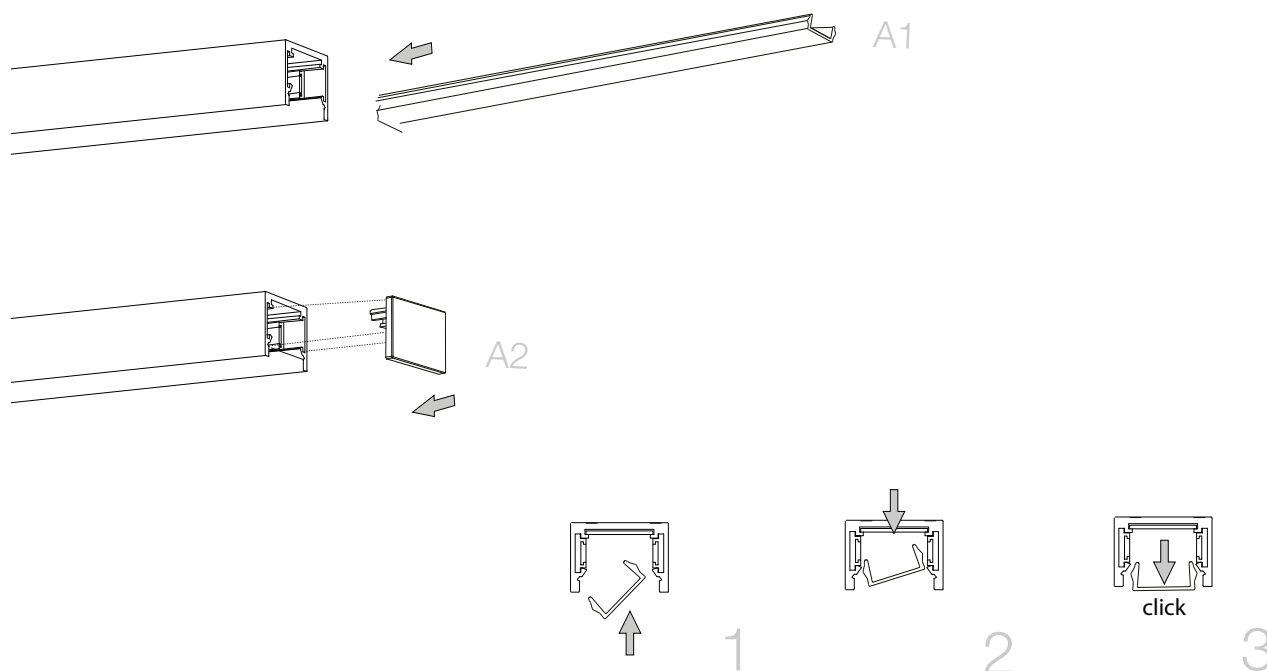

Sorgente luminosa e driver non sostituibili: a fine vita l'apparecchio andrà smaltito / Non-replaceable light source and control gear: at the end of its life, the lamp
 must be disposed.

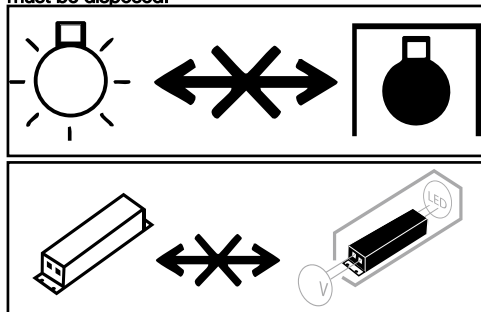

**Questo prodotto contiene una sorgente luminosa
 di classe di efficienza energetica /
 This product is provided with a light source
 with efficiency energy class of:**

EAN	Modello Sorgente Luminosa /Light Source Model	Classe di Efficienza Energetica / Energy Efficiency Class
8021696344980	STICK ACCENT D30 2700K CRI90	F
8021696329468	STICK ACCENT D30 3000K CRI90	G
8021696364087	STICK ACCENT D30 3000K CRI90	G
8021696344997	STICK ACCENT D11 2700K CRI90	F
8021696343525	STICK ACCENT D11 3000K CRI90	F
8021696364094	STICK ACCENT D11 3000K CRI90	F
8021696345000	STICK ACCENT D60 2700K CRI90	F
8021696329475	STICK ACCENT D60 3000K CRI90	F
8021696369921	STICK ACCENT D60 3000K CRI90	F
8021696345017	STICK ACCENT D22 2700K CRI90	F
8021696343532	STICK ACCENT D22 3000K CRI90	F
8021696369952	STICK ACCENT D22 3000K CRI90	F
8021696374307	STICK TRACK MODULE D2.2 3000K CRI90	G
8021696369969	STICK TRACK MODULE D3.2 3000K CRI90	G
8021696364100	STICK TRACK MODULE D2.2 3000K CRI90	G
8021696364117	STICK TRACK MODULE D3.2 3000K CRI90	G
8021696369983	STICK TRACK MODULE 07W 3000K CRI90	E
8021696364124	STICK TRACK MODULE D3.2 2700K CRI90	E

8021696364124	STICK TRACK MODULE 10W 3000K CRI90	F
8021696345024	STICK TRACK MODULE D2.2 2700K CRI90	F
8021696329512	STICK TRACK MODULE D2.2 3000K CRI90	G
8021696345031	STICK TRACK MODULE D3.2 2700K CRI90	E
8021696329536	STICK TRACK MODULE D3.2 3000K CRI90	G
8021696345048	STICK TRACK MODULE D2.2 2700K CRI90	F
8021696329505	STICK TRACK MODULE D2.2 3000K CRI90	G
8021696345055	STICK TRACK MODULE D3.2 2700K CRI90	E
8021696329529	STICK TRACK MODULE D3.2 3000K CRI90	G
8021696345062	STICK TRACK MODULE 07W 2700K CRI90	E
8021696343501	STICK TRACK MODULE 07W 3000K CRI90	E
8021696345079	STICK TRACK MODULE 10W 2700K CRI90	F
8021696343518	STICK TRACK MODULE 10W 3000K CRI90	F
8021696345086	STICK WIDE D30 2700K CRI90	F
8021696329444	STICK WIDE D30 3000K CRI90	G
8021696364131	STICK WIDE D30 3000K CRI90	G
8021696345093	STICK WIDE D60 2700K CRI90	E
8021696329451	STICK WIDE D60 3000K CRI90	F
8021696374291	STICK WIDE D60 3000K CRI90	F

LEGENDA ICONE

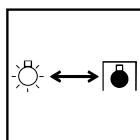

Sorgente luminosa sostituibile dall'utente finale.
Replaceable light source by an end-user.

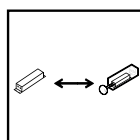

Dispositivo di alimentazione sostituibile dall'utente finale.
Replaceable control gear by an end-user.

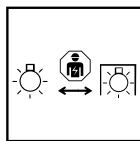

Sorgente luminosa sostituibile esclusivamente da personale autorizzato.
Replaceable light source by authorized personnel only.

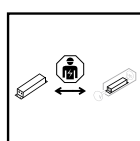

Dispositivo di alimentazione sostituibile esclusivamente da personale autorizzato.
Replaceable control gear by authorized personnel only.

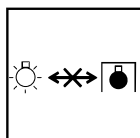

Sorgente luminosa non sostituibile. Quando la sorgente arriverà a fine vita dovrà essere sostituito l'intero apparecchio.
Non-replaceable light source. Upon end of life of the light source, the whole product will be replaced.

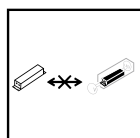

Dispositivo di alimentazione non sostituibile. Quando il dispositivo di alimentazione arriverà a fine vita dovrà essere sostituito l'intero apparecchio.
Upon end of life of the control gear, the whole product will be replaced.

- 18.** Jei apsauginis stiklas yra įskilęs arba sudužęs, pakeiskite jį nedelsiant ir naudodami tik nuostatus atitinkančias keičiamas dalis.
- 19.** Šviesos šaltinis su nekeičiamais šviesos diodais (LED). Neišmontuokite gaminio, nes diodai gali pažeisti akis. Nejmerkite į vandenį. Valykite naudodami drėgną šluostę ir venkite stiprių tirpiklių ir ploviklių naudojimo.
- 20.** Prietaise įdiegtas lydysis saugiklis. Jei šviestuvą neįsijungia, pakeiskite lydijį saugiklį.
- 21.** I-ą elektros saugos klasę užtikrina bendra izoliacija bei apsauginis laidininkas (žeminimas) prijungtas prie metalinės šviestuvo dalies. Privalomas žeminimas
- 22.** II-ą elektros saugos klasę užtikrina bendra izoliacija ir dviguba izoliacija arba sustiprinta izoliacija. Žeminimas nėra būtinas.
- 23.** III-ą elektros saugos klasę užtikrina labai žemos įtampos maitinimas (mažesnis, nei 50 voltų). Žeminimas nėra būtinas.
- 24.** Neapsaugotas.
- 25.** Apsaugotas nuo kietųjų kūnų, kurių skersmuo didesnis, nei 50 mm. patekimo.
- 26.** Apsaugotas nuo kietųjų kūnų, kurių skersmuo didesnis, nei 12 mm. patekimo.
- 27.** Apsaugotas nuo kietųjų kūnų, kurių skersmuo didesnis, nei 2,5 mm. patekimo.
- 28.** Apsaugotas nuo kietųjų kūnų, kurių skersmuo didesnis, nei 1 mm. patekimo.
- 29.** Apsaugotas nuo dulkių patekimo.
- 30.** Visiškai apsaugotas nuo dulkių patekimo.
- 31.** Neapsaugotas.
- 32.** Apsaugotas nuo statmenai krentančių vandens lašų patekimo.
- 33.** Apsaugotas nuo vandens lašų, kurių kritimo didžiausias kampas yra 15°, patekimo.
- 34.** Apsaugotas nuo lietaus.
- 35.** Apsaugotas nuo vandens pūslių.
- 36.** Apsaugotas nuo vandens čiurkšlių.
- 37.** Apsaugotas nuo stiprių vandens čiurkšlių.
- 38.** Apsaugotas nuo laikino įmerkimo.
- 39.** Apsaugotas nuo įmerkimo tam tikram laikui.
- 40.** Prietaisas neturi būti uždengiamas šilumą izoliuojančia medžiaga.
- 41.** Dėmesio, elektros smūgio pavojus.
- 42.** Nežiūrėkite tiesiai į šviesos šaltinį.