



General info

Technical - Systems

Ean	8021696241968
Item	LINUS SP 3000K WH
Installation	Systems
Guarantee	5 years
Gross weight	2.92 kg
Volume	0.01575 m ³

Technical info

Net weight	2.55 kg
Insulation class	I
Protection index	IP20
Compliance	CE
Operating temperature	0° ~ +40 °C
Dimmer	1, 1-10V
Power output	100-240 V AC 50/60 Hz
Power supply	In-built, included Replaceable (by qualified operators only), electronic
Accessories not included	Structure linear connector, Luminous corners

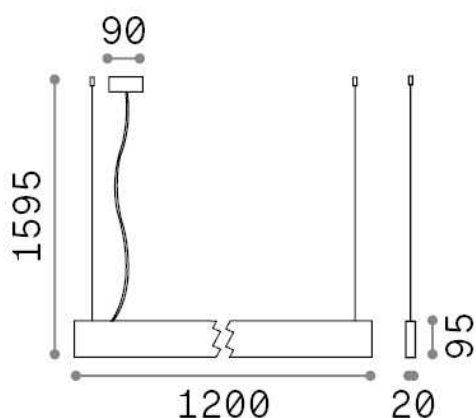

Source info

Integrated source	Integrated LED module
Replaceable source	No
Power	32 W
Emission	Direct + Indirect
Max consumption	max 32,00 W
Features LED	LED SMD
CCT LED	3000 K
Duration LED (t. 25°C)	50000 h
CRI	> 80
SDCM	3
Light beam	104+104°
Light beam flux	3450 lm
Useful light flux	3060 lm
Photobiological risk	1
Standby power	< 0.50 W