

Informations générales

Technique - Lampes à encastrer



Ean	8021696267975
Article	GAME TRIM ROUND 11W 4000K WH WH
Installation	Lampes à encastrer
Garantie	5 years
Poids brut	0.4 kg
Le volume	0.001634 m ³

Info technique

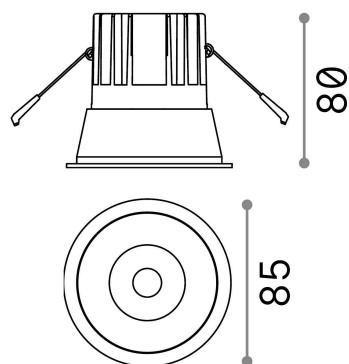

Poids net	0.35 kg
Classe d'isolation	II
Indice de protection	IP20
Conformité	CE
Température de fonctionnement	0° ~ +40 °C
Dimmer	NO, On-Off
Puissance de sortie	220-240 V AC 50/60 Hz
Source de courant	Separate, included Replaceable (by qualified operators only), electronic
Spécifications encastrées	Ø 75 - h. ≥ 150 , 3-40
Résistance à la charge	IK06
Indice de protection avant	IP40 [DO NOT COVER]
Accessoires non inclus	Dimmable driver

Informations sur la source

Source intégrée	Integrated LED module
Source remplaçable	Replaceable (by qualified operators only)
la puissance	11 W
Émissions	Direct
Consommation maximale	max 11,00 W
Caractéristiques LED	LED COB CREE
CCT LED	4000 K
Durée LED (t. 25°C)	50000 h
CRI	> 80
Angle de faisceau lumineux	36°
UGR Maximum	< 19
Flux du faisceau lumineux	1250 lm
Flux lumineux utile	1150 lm
Risque photobiologique	2