



Informations générales

Téchnique - Systèmes

Ean	8021696268231
Article	LINUS SP 4000K WH
Installation	Systèmes
Garantie	5 years
Poids brut	2.92 kg
Le volume	0.01575 m ³

Info technique

Poids net	2.55 kg
Classe d'isolation	I
Indice de protection	IP20
Conformité	CE
Température de fonctionnement	0° ~ +40 °C
Dimmer	1, 1-10V
Puissance de sortie	100-240 V AC 50/60 Hz
Source de courant	In-built, included Replaceable (by qualified operators only), electronic
Accessoires non inclus	Structure linear connector, Luminous corners

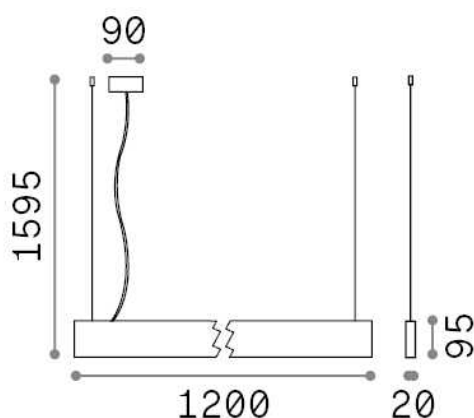

Informations sur la source

Source intégrée	Integrated LED module
Source remplaçable	No
la puissance	32 W
Émissions	Direct + Indirect
Consommation maximale	max 32,00 W
Caractéristiques LED	LED SMD
CCT LED	4000 K
Durée LED (t. 25°C)	50000 h
CRI	> 80
SDCM	3
Angle de faisceau lumineux	104+104°
Flux du faisceau lumineux	3600 lm
Flux lumineux utile	3190 lm
Risque photobiologique	1
Alimentation de secours	< 0.50 W